

# WATER PUMP CATALOGUE

## TRUCK & BUS SECTION

### ALL MAKES

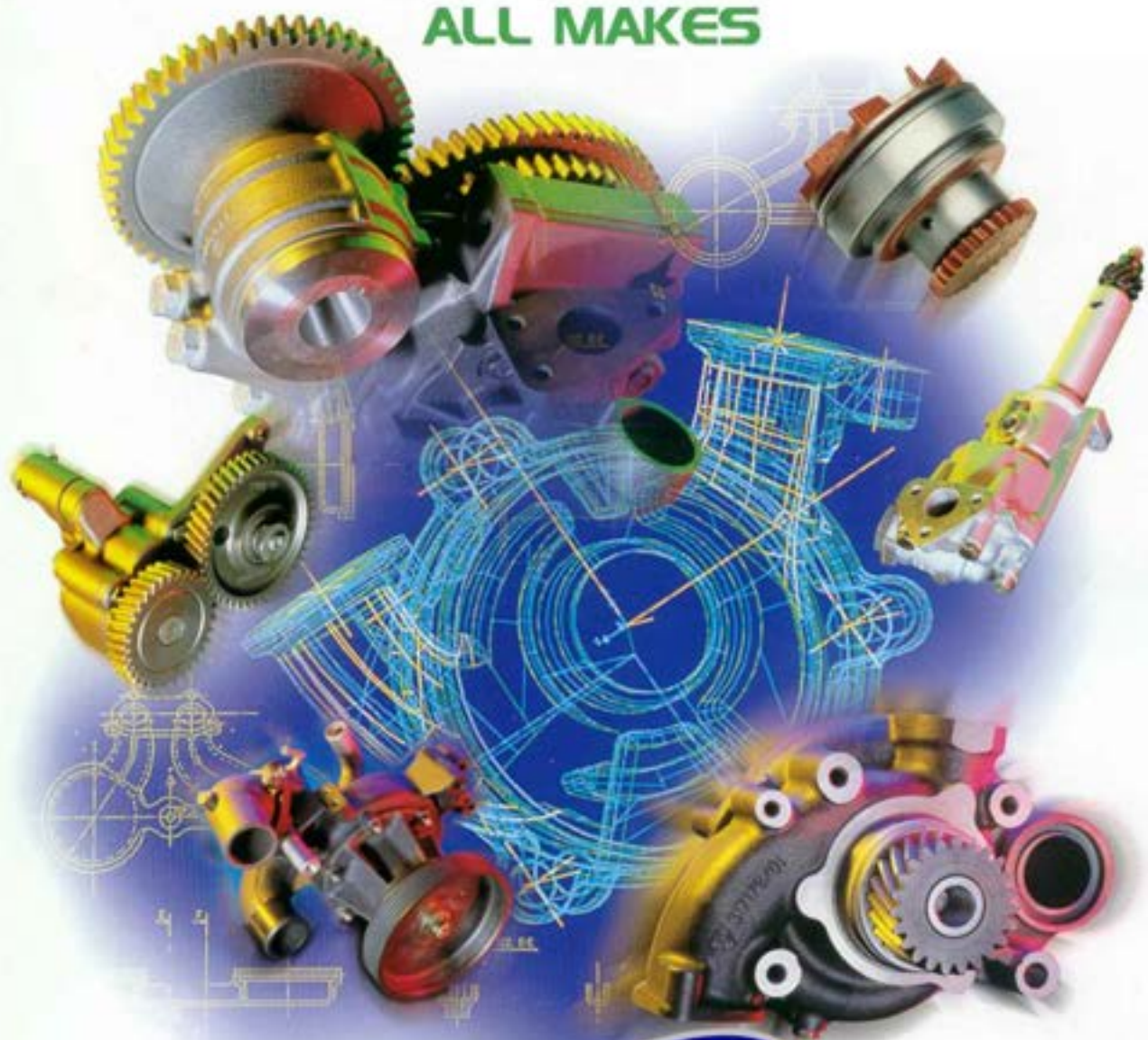

# SP

## WATER PUMPS

### WEB EDITION

S.P. WATER PUMPS LTD

18 Tatton Court, Kingsland Grange, Woolston,  
Warrington, Cheshire. ENGLAND. WAI 4RR

TEL: +44(0)1925 850082 FAX: +44(0)1925 850083

Email:sales@spwaterpumps.co.uk Web Site:www.spwaterpumps.co.uk



## **SECTION 17**

# **APPLICATION**

# **FORD**

## **INDUSTRIAL ENGINES**

**WATER PUMPS WASSERPUMPEN**  
**POMPE A EAU BOMBA DE AGUA**  
**POMPA ACQUA**

**S.P. WATER PUMPS LTD**  
18 Tatton Court, Kingsland Grange, Woolston,  
Warrington, Cheshire. ENGLAND. WAI 4RR  
TEL: +44(0) 1925 850082 Fax: +44(0) 1925 850083  
Email:sales@spwaterpumps.co.uk Web Site:www.spwaterpumps.co.uk

SUITABLE

# FORD

## INDUSTRIAL ENGINES

Tel:+44(0)1925 850082 Fax: +(0)44 1925 850083

www.spwaterpumps.co.uk



MOTORE  
MOTEUR  
ENGINE

POMPA ACQUA  
POMPE A EAU  
WATER PUMP

OMP REF.

O.EM. REF.

**2722**

**164.145**

826F8501ABA

6174469

**2725**

**4 CYL.**

**2726 T**

**6 CYL.**

**2726 TM**

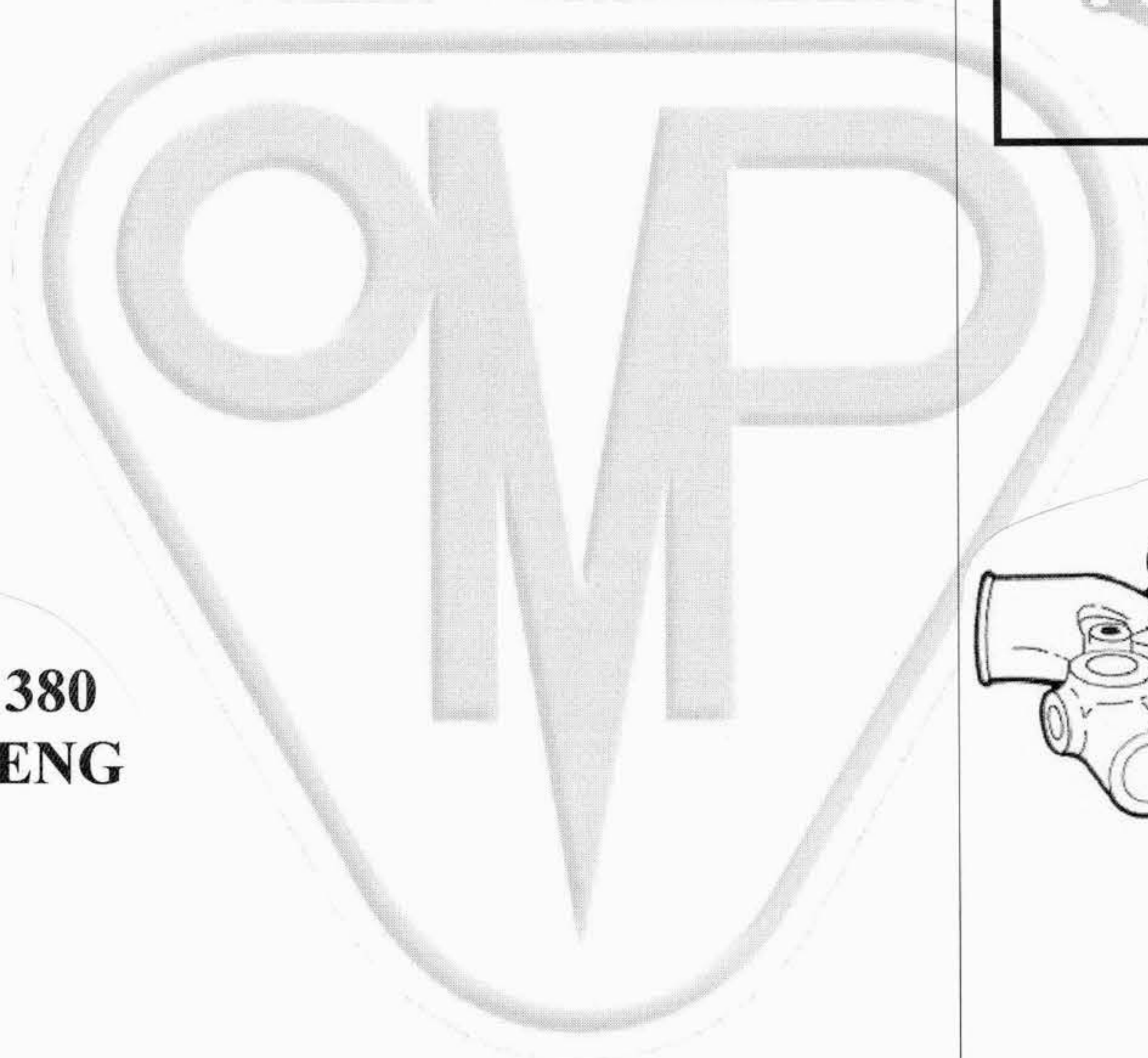
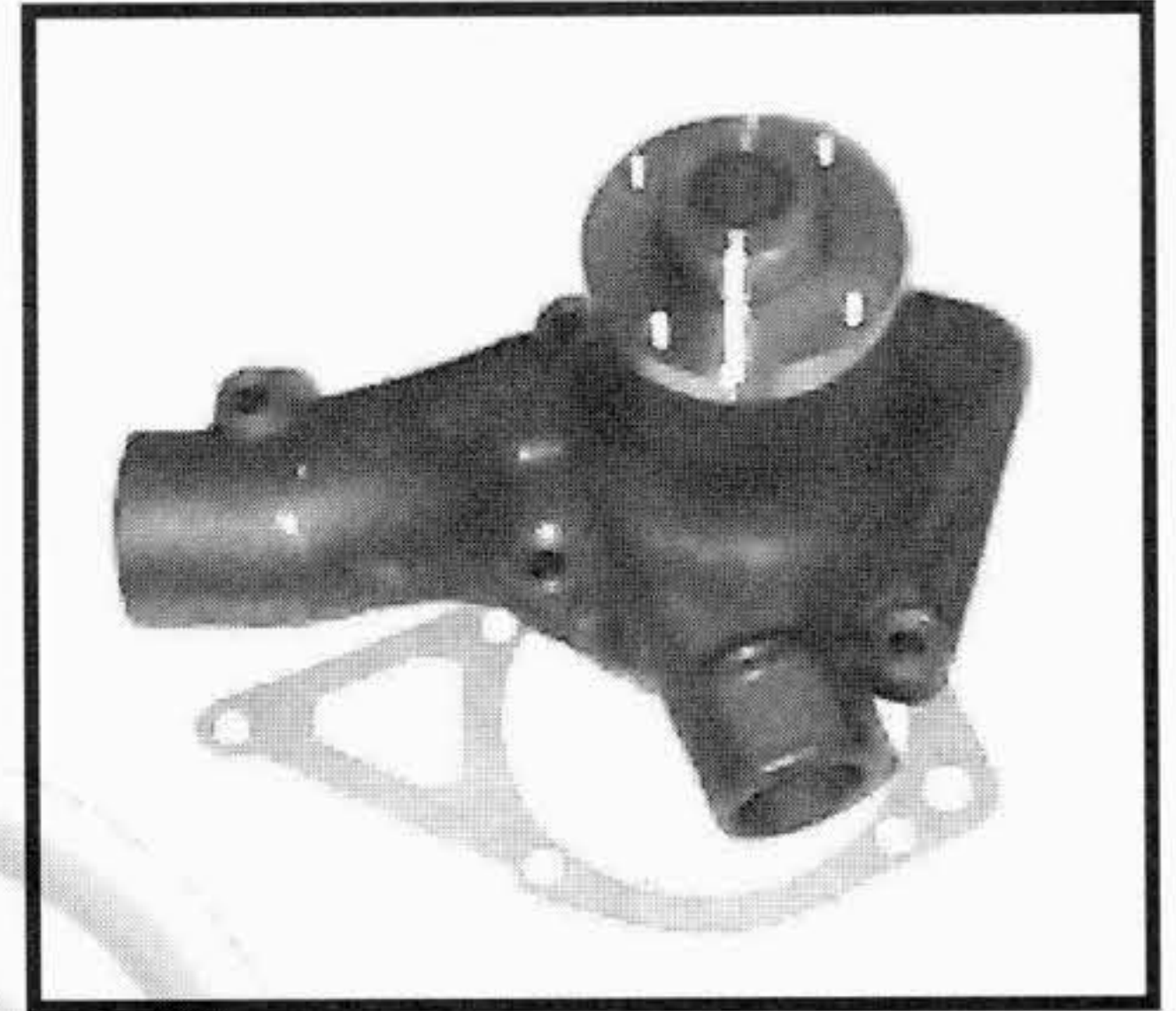

**5008468**  
**813, 365, 380**  
**DOVER ENG**

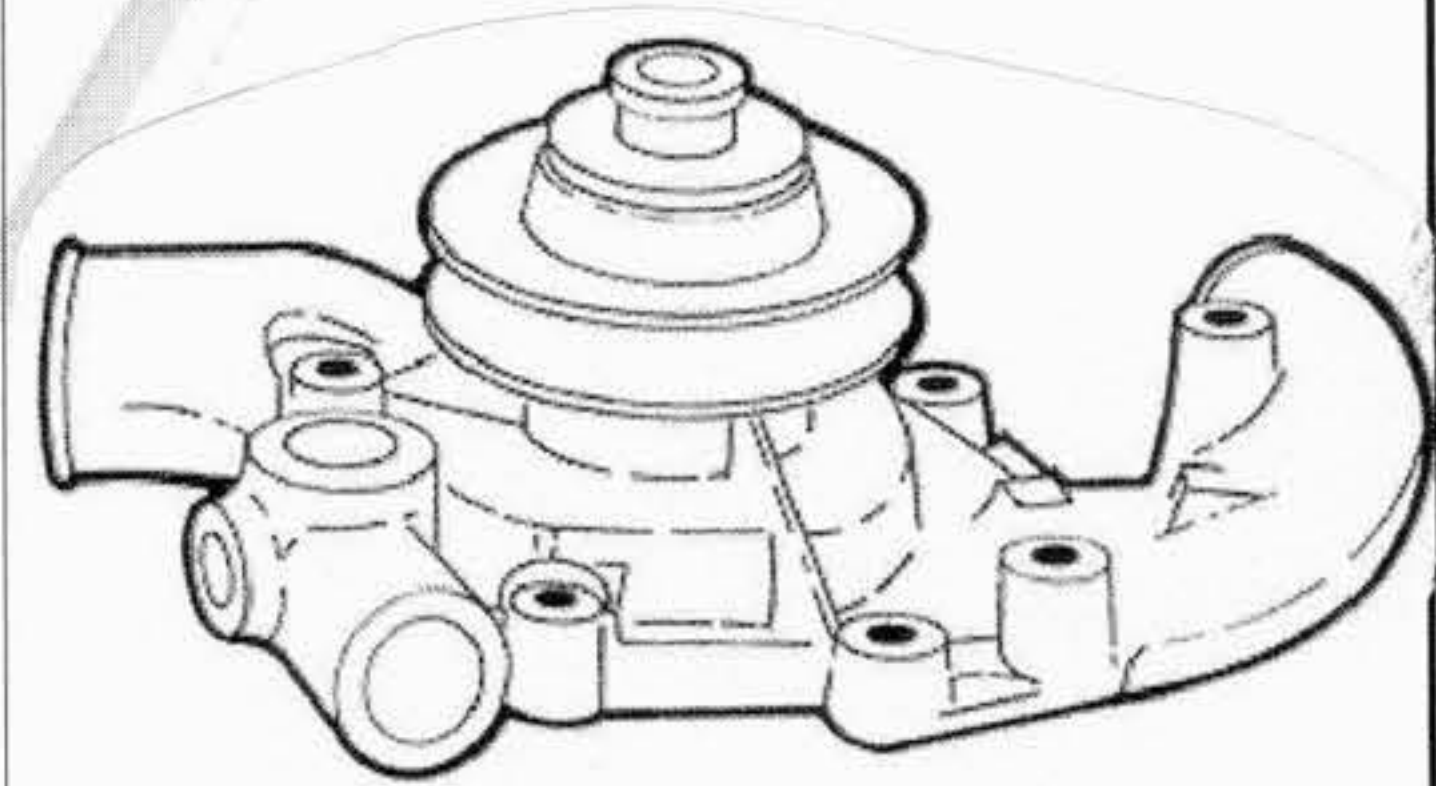

**5024545**  
**TRANSIT 2.5**

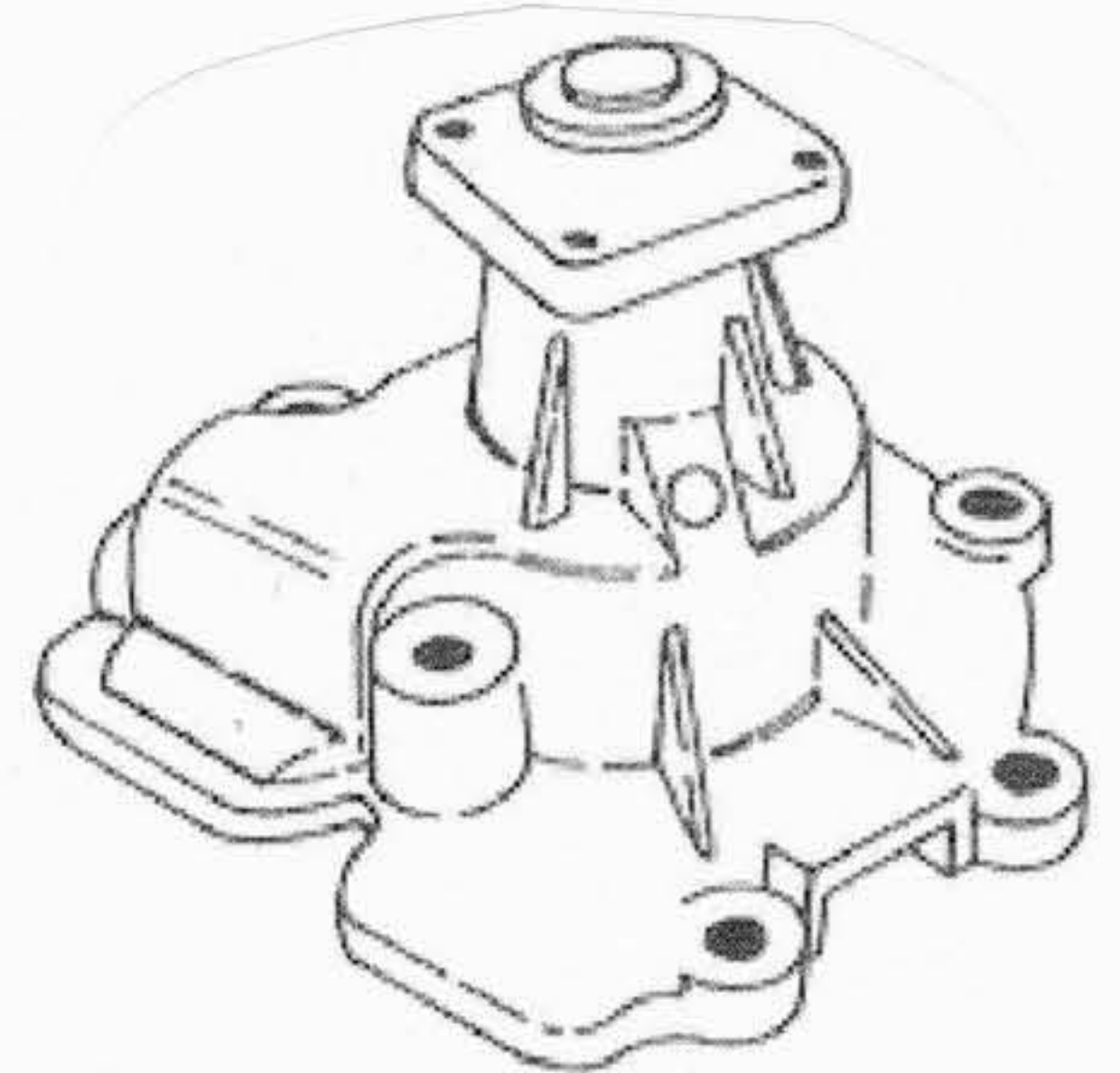



**SECTION 16**

**APPLICATION**

**NEW  
HOLLAND**

**AGRIFULL - FIAT ALLIS  
FIAT HITACHI - SIMIT - BENATI  
FIAT TRATTORI - LAVERDA - FORD**

**WATER PUMPS WASSERPUMPEN  
POMPE A EAU BOMBA DE AGUA  
POMPA ACQUA**

**S.P. WATER PUMPS LTD  
18 Tatton Court, Kingsland Grange, Woolston,  
Warrington, Cheshire. ENGLAND. WAI 4RR  
TEL: +44(0) 1925 850082 Fax: +44(0) 1925 850083  
Email:sales@spwaterpumps.co.uk Web Site:www.spwaterpumps.co.uk**

TAVOLE DI CONVERSIONE  
TABLE DE CONVERSION  
CONVERSION TABLE

NEW HOLLAND

AGRIFULL - FIAT ALLIS  
FIAT HITACHI - SIMIT  
BENATI - FIAT TRATTORI  
LAVERDA



NUMERO ORIGINALE NUMERO ORIGINAL ORIGINAL NUMBER	NUMERO SOSTITUTIVO REPLACE PAR NUMERO REPLACED BY NUMBER	RIFERIMENTO OMP REFERENCE OMP OMP REFERENCE
89034	U7LW0006	
89036	U7LW0009	
539672		201.584
540454		211.462
540456	VEDI 777.837	211.461
540461	VEDI 777.837	211.467
543747	ESAUrito	
546018		201.586
549420	ESAUrito	
549421	ESAUrito	
550734	ESAUrito	
552113		211.445
552161		211.454
552162		211.459
552163		211.452
552164		211.447
552165		211.446
552170		211.466
552387		201.587
552402	581677	
552406		196.012
552408		208.086
552478		ESAUrito
554148		ESAUrito
554150		208.035
554568		191.157
554571		191.164
559213		191.266
560226		208.040
560948		201.139
560949		191.188
561229		201.431
561232		201.428
561233		201.434
561234		201.535
561235		201.530
561242		208.085
561514		201.420
562499	4581535	
562988		191.155
562993		191.162
565079		ESAUrito
565236		228.003
565394		201.396
565395	4605899	
565396		201.419
565511		201.453

NUMERO ORIGINALE NUMERO ORIGINAL ORIGINAL NUMBER	NUMERO SOSTITUTIVO REPLACE PAR NUMERO REPLACED BY NUMBER	RIFERIMENTO OMP REFERENCE OMP OMP REFERENCE
565975		ESAUrito
566286		201.395
566997		201.390
567400		201.398
569397		201.392
569406		201.369
569659		ESAUrito
570636		ESAUrito
570638		208.087
570639		208.017
570888	4138766	
570948		ESAUrito
572196		ESAUrito
572725		ESAUrito
572845		201.006
574352	AD ESAUR.	198.057
574526	VEDI 777.182	
574712		208.004
574714		ESAUrito
574965		ESAUrito
577837		221.450
580087		208.100
580210		201.588
580301		ESAUrito
580303		228.002
581677		201.577
581678	586018	
581679		208.093
586017		201.590
586018		208.094
586861		ESAUrito
588613	598876	
589323	562988	
590795		208.031
594278		ESAUrito
594281		ESAUrito
594650		ESAUrito
594656		ESAUrito
594660		ESAUrito
595367		201.947
596443		ESAUrito
598378		ESAUrito
598876		228.007
813579	VEDI 777.988	
841062	VEDI 777.988	
841767		191.027
844379	VEDI 777.988	

OGNI RIFERIMENTO ORIGINALE E' ASSOLUTAMENTE INDICATIVO. CHAQUE REFERENCE ORIGINAL EST ABSOLUMENT INDICATIVE. EVERY ORIGINAL PART NUMBER HAS TO BE CONSIDERED FOR REFERENCE PURPOSE ONLY.

TAVOLE DI CONVERSIONE  
TABLE DE CONVERSION  
CONVERSION TABLE

NEW HOLLAND

AGRIFULL - FIAT ALLIS  
FIAT HITACHI - SIMIT  
BENATI - FIAT TRATTORI  
LAVERDA



NUMERO ORIGINALE NUMERO ORIGINAL ORIGINAL NUMBER	NUMERO SOSTITUTIVO REPLACE PAR NUMERO REPLACED BY NUMBER	RIFERIMENTO OMP REFERENCE OMP OMP REFERENCE
882723		191.405
969761		191.534
999285	Gh	191.160
0170040		251.184
0500006		251.191
0576007		259.031
0920009		259.032
0920058		251.772
1756143		203.155
1756186		203.160
1756509		203.154
1756510		201.815
1756511		201.805
1756512		203.162
1756513		203.153
1756514		203.156
1909615		202.056
1909616	1909952	
1909617	1909829	
1909619		202.025
1909620	ad esaurimento	202.049
1909621	ad esaurimento	202.029
1909623		202.041
1909624	76031329	
1909625		202.033
1909626	76029352	
1909627		202.053
1909635	ESAURITO	
1909789	1930262	
1909790		201.929
1909829		202.016
1909952	76032963	
1930196	1930445	
1930262	1940119	
1930445	1940105	
1930925		196.326
1940104		222.261
1940105		222.264
1940119		202.268
1940144		222.281
2331154		259.041
4171520	11060275	
4519897	4557736	
4537931		261.282
4541160		ESAURITO
4541161		ESAURITO
4541162		ESAURITO

NUMERO ORIGINALE NUMERO ORIGINAL ORIGINAL NUMBER	NUMERO SOSTITUTIVO REPLACE PAR NUMERO REPLACED BY NUMBER	RIFERIMENTO OMP REFERENCE OMP OMP REFERENCE
4547439	VEDI 777.897	
4547452		191.293
4547543		191.279
4547634	VEDI 777.897	
4547637	VEDI 777.897	
4547912		191.277
4557736	4613393	
4581535		208.084
4585990	4587258	
4587048		191.192
4587050		191.186
4587258		191.183
4591436		191.283
4591437		191.290
4591438		201.203
4592557		191.278
4593236		201.538
4593322		208.082
4593360		ESAURITO
4594089	4602503	
4595833		201.513
4599557		191.237
4599560	VEDI 777.182	
4599561	VEDI 777.182	
4599562	VEDI 777.182	
4599563	VEDI 777.182	
4600130		208.018
4600187		ESAURITO
4602502		191.285
4602503		191.190
4603862	4617099	
4603866	4612265	
4603868	4654154	
4603869	4654154	
4603870		191.207
4603871		191.231
4605899		201.594
4606028		191.304
4606030		191.298
4606031	4757006	
4606032	4619257	
4606033		191.299
4606034	VEDI 777.023	
4606042	VEDI 777.023	
4606046	VEDI 777.023	
4606051		191.297
4606070	4622485	

OGNI RIFERIMENTO ORIGINALE E' ASSOLUTAMENTE INDICATIVO. CHAQUE REFERENCE ORIGINAL EST ABSOLUMENT INDICATIVE. EVERY ORIGINAL PART NUMBER HAS TO BE CONSIDERED FOR REFERENCE PURPOSE ONLY.

TAVOLE DI CONVERSIONE  
TABLE DE CONVERSION  
CONVERSION TABLE

NEW HOLLAND

AGRIFULL - FIAT ALLIS  
FIAT HITACHI - SIMIT  
BENATI - FIAT TRATTORI  
LAVERDA



NUMERO ORIGINALE NUMERO ORIGINAL ORIGINAL NUMBER	NUMERO SOSTITUTIVO REPLACE PAR NUMERO REPLACED BY NUMBER	RIFERIMENTO OMP REFERENCE OMP OMP REFERENCE
4606094	VEDI 777.023	
4606783		228.166
4606784		ESAURO
4611308		4658400
4612264		4639096
4612265		4622265
4612675		4655054
4613393		4613395
4613395		191.280
4613684		ESAURO
4616630		191.249
4617099		201.982
4619257		4757008
4619285		ESAURO
4619286		ESAURO
4621413		208.078
4622265		4639097
4622324		ESAURO
4622485		4666429
4622591		208.065
4622957		198.114
4628338		198.169
4629940		201.596
4629942		208.101
4629943		208.102
4629944		201.592
4639096		191.138
4639097		191.239
4642042		191.142
4651309		198.109
4654154		191.247
4655011		191.260
4655014	4736987	
4655054	4679242	
4658400		191.294
4666429	AD ESAUR.	198.048
4671954		191.382
4672087	VEDI 777.786	
4672088	VEDI 777.786	
4673810	VEDI 777.182	
4677587	VEDI 777.786	
4679242	93191101	
4679303	4679242	
4692491	4732395	
4692493		201.097
4692494		191.099
4692495		201.098

NUMERO ORIGINALE NUMERO ORIGINAL ORIGINAL NUMBER	NUMERO SOSTITUTIVO REPLACE PAR NUMERO REPLACED BY NUMBER	RIFERIMENTO OMP REFERENCE OMP OMP REFERENCE
4693901		ESAURO
4695786	4737154	
4696705		201.572
4696706		201.626
4696707	1930925	
4697121		208.185
4697144		201.094
4699618		228.244
4699831		228.284
4706879		201.669
4706880		201.682
4711702		191.686
4711704		191.667
4711705	VEDI 777.634	
4712083	VEDI 777.634	
4714271		228.287
4721390		228.248
4723063		196.327
4732064		201.959
4723065		221.958
4725903		201.087
4726361		201.931
4726860		201.921
4726861		201.919
4727139	4796534	
4727145		201.923
4731643		201.922
4732341	4761926	
4732378	4762039	
4732393	4757340	
4732394		ESAURO
4732395	4757341	
4736987		208.095
4737154	4764156	
4737157		198.250
4742370		201.961
4746402	4796537	
4752545		191.669
4752546		191.682
4755791		201.937
4755792		201.936
4755793		201.934
4757006		191.302
4757008		191.295
4757340		201.955
4757341		201.935
4758023		201.964

OGNI RIFERIMENTO ORIGINALE E' ASSOLUTAMENTE INDICATIVO. CHAQUE REFERENCE ORIGINAL EST ABSOLUMENT INDICATIVE. EVERY ORIGINAL PART NUMBER HAS TO BE CONSIDERED FOR REFERENCE PURPOSE ONLY.

TAVOLE DI CONVERSIONE  
TABLE DE CONVERSION  
CONVERSION TABLE

NEW HOLLAND

AGRIFULL - FIAT ALLIS  
FIAT HITACHI - SIMIT  
BENATI - FIAT TRATTORI  
LAVERDA



NUMERO ORIGINALE NUMERO ORIGINAL ORIGINAL NUMBER	NUMERO SOSTITUTIVO REPLACE PAR NUMERO REPLACED BY NUMBER	RIFERIMENTO OMP REFERENCE OMP OMP REFERENCE
4758025		228.255
4758190		201.975
4758191		201.985
4758268		201.977
4758269		228.256
4758414		201.962
4758415		228.261
4758416		201.963
4758417		228.262
4761559		228.278
4761615		206.010
4761955		228.279
4762001		228.263
4762039	4796531	
4763383		201.974
4764090		196.014
4764156		196.015
4764158		196.017
4770614	4813442	
4780568	4784454	
4784078	4829218	
4784454	4813370	
4787092	4808080	
4796529		206.053
4796531	4807113	
4796534		206.100
4796537		206.200
4800484	4813730	
4807113	98410023	
4807116		206.144
4807395		208.326
4808080		206.148
4813370		206.265
4813371		206.295
4813442		206.068
4813730	98497117	
4814563		208.340
4817651		206.380
4829218		206.077
4951264		ESAUrito
4951280		ESAUrito
4951415		208.032
4951829		208.133
4952496	79003080	201.965
4953502		208.034
4953503		208.188
4955190		201.680

NUMERO ORIGINALE NUMERO ORIGINAL ORIGINAL NUMBER	NUMERO SOSTITUTIVO REPLACE PAR NUMERO REPLACED BY NUMBER	RIFERIMENTO OMP REFERENCE OMP OMP REFERENCE
4959164		201.597
4959165		208.103
7130396		221.909
7302756		196.183
7302776	98421056	
8107660		206.205
8310085		ESAUrito
8310087		221.911
8312029		221.908
8312031		221.928
8312034		ESAUrito
8807765		211.456
8810326		211.463
8810327		221.468
8813011		191.407
8813157		191.406
8814938		191.414
8814939	VEDI 777.790	
8814940		191.415
8815774		ESAUrito
8815776		191.206
8815777		ESAUrito
8818176		ESAUrito
8818227		211.489
8818228		211.487
8818239	VEDI 777.780	
8819120	AD ESAUR.	198.074
8819324	8824528	
8819394		208.151
8819898		221.912
8820040	8822883	
8820041		221.482
8820042		221.486
8820043		221.481
8820044		221.479
8820045	AD ESAUR.	198.096
8821431		211.488
8821437		ESAUrito
8821438	VEDI 777.779	211.528
8821439		211.527
8821786		208.187
8822774	8829182	
8822833		211.529
8822971	8826871	
8822883	8829787	
8822887		221.493
8822950	AD ESAUR.	

OGNI RIFERIMENTO ORIGINALE E' ASSOLUTAMENTE INDICATIVO. CHAQUE REFERENCE ORIGINAL EST ABSOLUMENT INDICATIVE. EVERY ORIGINAL PART NUMBER HAS TO BE CONSIDERED FOR REFERENCE PURPOSE ONLY.



TAVOLE DI CONVERSIONE  
TABLE DE CONVERSION  
CONVERSION TABLE

NEW HOLLAND

AGRIFULL - FIAT ALLIS  
FIAT HITACHI - SIMIT  
BENATI - FIAT TRATTORI  
LAVERDA



NUMERO ORIGINALE NUMERO ORIGINAL ORIGINAL NUMBER	NUMERO SOSTITUTIVO REPLACE PAR NUMERO REPLACED BY NUMBER	RIFERIMENTO OMP REFERENCE OMP OMP REFERENCE
8822981		221.483
8823283	8829183	
8823963		198.116
8824005	VEDI 777.780	
8824006	8829187	201.607
8824049		228.153
8824528		208.098
8824708		201.613
8825046		208.152
8825427		ESAURO
8825545		8829780
8825548		228.149
8825550		228.148
8826053	8829793	
8826054		201.598
8826055		201.601
8826056	8829792	
8826073		191.599
8826149	VEDI 777.634	
8826839		
8826870		ESAURO
8826871		218.355
8826872		211.993
8826873		211.994
8827706		208.150
8827709		208.019
8827712		ESAURO
8827714		228.223
8827770		ESAURO
8828792		
8829126		191.418
8829127		191.402
8829148		191.409
8829182		191.492
8829183		191.476
8829184		211.521
8829187		201.608
8829329	VEDI 211.501	
8829330		211.499
8829331		211.501
8829779		211.520
8829780		201.606
8829787		221.485
8829790		201.490
8829792		191.464
8829793	4732393	
8829805		201.604

NUMERO ORIGINALE NUMERO ORIGINAL ORIGINAL NUMBER	NUMERO SOSTITUTIVO REPLACE PAR NUMERO REPLACED BY NUMBER	RIFERIMENTO OMP REFERENCE OMP OMP REFERENCE
8830638		228.259
8830732		201.920
10010290		201.388
10012490		211.448
10043690		201.583
10014890		201.582
10205720		191.167
10205820		191.191
10205920		191.281
10257460		201.602
10257060		191.533
10264660		201.084
10268450		201.953
10282460		191.384
10284585		201.512
10296685		201.509
10300611		191.383
10300771		191.532
10356111	30002797	
10516670		191.213
10520011	13550501	
10520101		201.992
10725627		201.954
10791040	12164740	
11059475		191.158
11059775		201.389
11060275		191.184
11060576		191.284
11061075		261.354
11061576		201.979
11062476		201.978
11190571		206.102
11198071		191.381
12164740		191.408
12429820		191.289
12430120		191.288
12575611		191.144
12638670		191.146
12644901		221.916
12644920		191.317
12683380	VEDI 777.837	
13301401		191.169
13301501		201.949
13303511		201.937
13403410	13408411	
13407811		191.268
13408411		191.166

OGNI RIFERIMENTO ORIGINALE E' ASSOLUTAMENTE INDICATIVO. CHAQUE REFERENCE ORIGINAL EST ABSOLUMENT INDICATIVE. EVERY ORIGINAL PART NUMBER HAS TO BE CONSIDERED FOR REFERENCE PURPOSE ONLY.

TAVOLE DI CONVERSIONE  
TABLE DE CONVERSION  
CONVERSION TABLE

NEW HOLLAND

AGRIFULL - FIAT ALLIS  
FIAT HITACHI - SIMIT  
BENATI - FIAT TRATTORI  
LAVERDA



NUMERO ORIGINALE NUMERO ORIGINAL ORIGINAL NUMBER	NUMERO SOSTITUTIVO REPLACE PAR NUMERO REPLACED BY NUMBER	RIFERIMENTO OMP REFERENCE OMP OMP REFERENCE
13449521		201.918
13449821		201.933
13517021		191.306
13517321		191.307
13517921		191.305
13550501		191.201
13598121		191.181
13598211		191.316
13739911		206.139
13748610		191.234
14044171		191.296
14325001		191.182
15888721		206.103
16043421		191.238
16043821		191.378
16043921		211.522
16044521		191.379
16100811		191.214
16109211		221.546
20556690		211.449
20558440		211.451
20885620		191.286
20888670		191.318
2418M001	2418M004	
2418M004		259.428
24940010		201.391
24940020		201.394
24940280		191.163
2521D406		259.158
26794880		191.355
28040050		201.549
28042300		191.187
28044120		191.185
30001037		201.497
30002797		191.411
31146952		259.015
3276P003		259.014
32764119	32764127	
32764124		259.078
32764127	3276P003	
3312K011		259.156
3312K012		251.204
3312N003		259.241
33143409		259.077
33157108		259.019
33157109		259.017
33813313		259.018

NUMERO ORIGINALE NUMERO ORIGINAL ORIGINAL NUMBER	NUMERO SOSTITUTIVO REPLACE PAR NUMERO REPLACED BY NUMBER	RIFERIMENTO OMP REFERENCE OMP OMP REFERENCE
36866271		259.042
36866724	36866271	
36867108		259.101
36867137		259.087
37447603		259.076
37447632		259.084
38823313		211.524
38823992		201.609
38824001	VEDI 777.780	
38824166		201.496
41312551	41312911	
41312557	41313018	
41312911	41313201	
41313018	41313045	
41313033	41313047	
41313045		159.090
41313047		159.260
41313201	41313225	
41313225	41313231	
41313231	4131A013	159.450
4131A013	4131A021	
4131A021		159.490
42530032		196.446
61088139		196.355
61315464		196.450
76029352		222.260
76030102		222.263
76031213		202.270
76031329		222.262
76032963		222.267
76032964		202.271
76032965		202.272
76032966		202.273
76032967		202.269
76191549		221.020
76192604		221.025
79003080	79014642	
79003084		228.280
79003086		
79003087		
79003088		
79011045		228.192
79013267		
79013268		
79014642	79037310	201.960
79014644		201.927
79014645		228.260

OGNI RIFERIMENTO ORIGINALE E' ASSOLUTAMENTE INDICATIVO. CHAQUE REFERENCE ORIGINAL EST ABSOLUMENT INDICATIVE. EVERY ORIGINAL PART NUMBER HAS TO BE CONSIDERED FOR REFERENCE PURPOSE ONLY.



TAVOLE DI CONVERSIONE  
TABLE DE CONVERSION  
CONVERSION TABLE

NEW HOLLAND FORD



NUMERO ORIGINALE NUMERO ORIGINAL ORIGINAL NUMBER	NUMERO SOSTITUTIVO REPLACE PAR NUMERO REPLACED BY NUMBER	RIFERIMENTO OMP REFERENCE OMP OMP REFERENCE
E2169T9	E158Z9	
E158Z9		162.130
34806S36		161.381
87652S2		161.182
304758S36		164.008
957E8501B		164.080
957E8505B		169.301
957E8507		169.068
957E8509		164.072
957E8512		169.061
C3AE8564A	C5NE8564B1A	
C5NE8A514A		164.044
C5NE8501A	C5NF8501A	
C5NE8507A		164.047
C5NE8509A		164.005
C5NE8513A		164.011
C5NE8530B		164.001
C5NE8564B1A		161.042
C5NE8578B		164.001
C5NF8501A	C5NN8501A	
C5NN8501A	D5NN8501E	
C7NN8516A		164.006
C9NN8501A	D8NN8501MB	
C9NN8501B	D8NN8501MB	
CFPN8591A	DJPN8591A	
D3NN8501A	D5NN8501E	
D5NN8A528A		164.105
D5NN8A528B		164.035
D5NN8501E	D8NN8501UA	164.000
D5NN8505A		164.012
D5NN8512BA	D8NN8512BA	
D5TE8A559C1A		169.428
D5TE8564B1A		161.042
D8NN8A513MC	FAPN8A513GG	
D8NN8501MB	D8NN8501MC	
D8NN8501MC	VEDI 164.093	
D8NN8501PA	D8NN8501TC	
D8NN8501PB	D8NN8501TC	
D8NN8501SB	D8NN8501MB	
D8NN8501TB	D8NN8501TC	
D8NN8501TC		164.091
D8NN8501UA	D8NN8501UB	164.060
D8NN8501UB	D8NN8501UC	
D8NN8501UC		164.087
D8NN8505AB		164.063
D8NN8512AA		164.048
D8NN8512BA		164.054

NUMERO ORIGINALE NUMERO ORIGINAL ORIGINAL NUMBER	NUMERO SOSTITUTIVO REPLACE PAR NUMERO REPLACED BY NUMBER	RIFERIMENTO OMP REFERENCE OMP OMP REFERENCE
D8NN8530AA	D8NN8530AB	
D8NN8530AB		164.016
DHPN8A513A	EAPN8A513G	
DHPN8A513B	EAPN8A513G	
DHPN8A513C	DHPN8A513F	164.055
DHPN8A513F	EAPN8A513F	164.065
DJPN8A513C	EAPN8A513F	
DJPN8591A		162.147
DJPN8591B		162.148
E6NN8501AA	VEDI 164.185	
E6NN8501CA		164.113
E6NN8501DA	E6NN8501DB	
E6NN8501DB	E6NN8501DC	
E6NN8501DC		164.106
E6NN8505BA		164.104
E6NN8508BA		164.112
E6NN8513AA		164.108
E6NN8A513DA	E6NN8A513DB	
E6NN8A513DB	E6NN8A513DC	
E6NN8A513DC		164.107
E7NN8501EB		164.175
E7NN8501FB	E7NN8501FD	
E7NN8501FD	E7NN8501FE	
E7NN8501FE		164.096
E7NN8501GA	E7NN8501FB	
E7NN8A513CA	E7NN8A513CB	
E7NN8A513CB	E7NN8A513CE	
E7NN8A513CE		164.097
EAPN8A513B	EAPN8A513E	
EAPN8A513D	EAPN8A513E	
EAPN8A513E		164.092
EAPN8A513F		164.088
EAPN8A513G		164.093
EAPN8591A	EAPN8591D	
EAPN8591B	EAPN8591E	
EAPN8591C		162.149
EAPN8591D		162.200
EAPN8591E		162.207
FBPN8591A		162.156
FBPN8591B		162.157
EGPN8A513CA		164.114
EGPN8A513D	E6NN8A513DA	
EGPN8591CA		162.151
EGPN8591DA		162.150
EJPN8A513BA		164.185
EJPN8A513EB		164.180
EJPN8A513FB	E7NN8A513CA	

OGNI RIFERIMENTO ORIGINALE E' ASSOLUTAMENTE INDICATIVO. CHAQUE REFERENCE ORIGINAL EST ABSOLUMENT INDICATIVE. EVERY ORIGINAL PART NUMBER HAS TO BE CONSIDERED FOR REFERENCE PURPOSE ONLY.

TAVOLE DI CONVERSIONE  
TABLE DE CONVERSION  
CONVERSION TABLE

NEW HOLLAND

FORD



NUMERO ORIGINALE NUMERO ORIGINAL ORIGINAL NUMBER	NUMERO SOSTITUTIVO REPLACE PAR NUMERO REPLACED BY NUMBER	RIFERIMENTO OMP REFERENCE OMP OMP REFERENCE
EJPN8591AA		162.152
EJPN8591EB		162.153
EJPN8591FB		162.154
FONN8501CC		164.165
FONN8501DC		164.170
FAPN8A513GG	EGPN8A513D	
E1ADKN8501B	E1ADKN8501C	
E1ADKN8501C		164.010
E1ADKN8505B		164.038
E1ADKN8507A		164.041
E1ADKN8507B		164.042
E1ADKN8512		164.039
E1ADKN8530		169.066
E1ADKN8564		161.042
E1ADKN8567C		164.037
E1ADKN8576		164.043
E1ADKN8591		162.137
RIF. FINISH CODE NUMERO FINISH CODE FINISH CODE NUMBER	FINISH CODE SOSTITUTIVO REPLACE PAR NUMERO REPLACED BY NUMBER	RIFERIMENTO OMP REFERENCE OMP OMP REFERENCE
1711728	81711728	
1711772	81711772	
1863830	81863830	
1863835	81863835	
1863837	81863837	
1863898	81863898	
1863909	81863909	
1863921	81863921	
1863952	81863952	
1863983	81863983	
1863991	81863991	
1864001	81864001	
1866488	81866488	
1866491	81866491	
1869616	81869616	
1869617	81869617	
1872277	81872277	
1872282	81872282	
1872287	81872287	
1872289	81872289	
1872290	81872290	
1876233	81876233	
3914014	83914014	
3914015	83914015	
3926001		164.092
3926002		164.088
3926011		162.149
3926012	3956725	

RIF. FINISH CODE NUMERO FINISH CODE FINISH CODE NUMBER	FINISH CODE SOSTITUTIVO REPLACE PAR NUMERO REPLACED BY NUMBER	RIFERIMENTO OMP REFERENCE OMP OMP REFERENCE
3956722	1863837	
3956725	83956725	
3956729	83956729	
3961311	83961311	
3964038	1863909	
81711728		164.010
81711772		162.137
81863830		164.097
81863835		164.185
81863837		164.114
81863898		164.107
81863909		164.180
81863921		164.093
81863952		162.151
81863983		162.153
81863991		162.152
81864001		162.154
81866488		162.156
81866491		162.157
81869616		164.165
81869617	= 87800714	164.170
81872277		164.106
81872282	VEDI 164.093	
81872287		164.175
81872289		164.096
81872290	VEDI 164.185	
81876233		164.113
83914014		162.147
83914015		162.148
83956725		162.200
83956729		162.150
83961311		162.207
87790240		
87800490		
87800714	= 81869617	164.170

OGNI RIFERIMENTO ORIGINALE E' ASSOLUTAMENTE INDICATIVO. CHAQUE REFERENCE ORIGINAL EST ABSOLUMENT INDICATIVE. EVERY ORIGINAL PART NUMBER HAS TO BE CONSIDERED FOR REFERENCE PURPOSE ONLY.

SUITABLE

**NEW HOLLAND****FIAT ALLIS  
FIATHITACHI  
SIMIT**

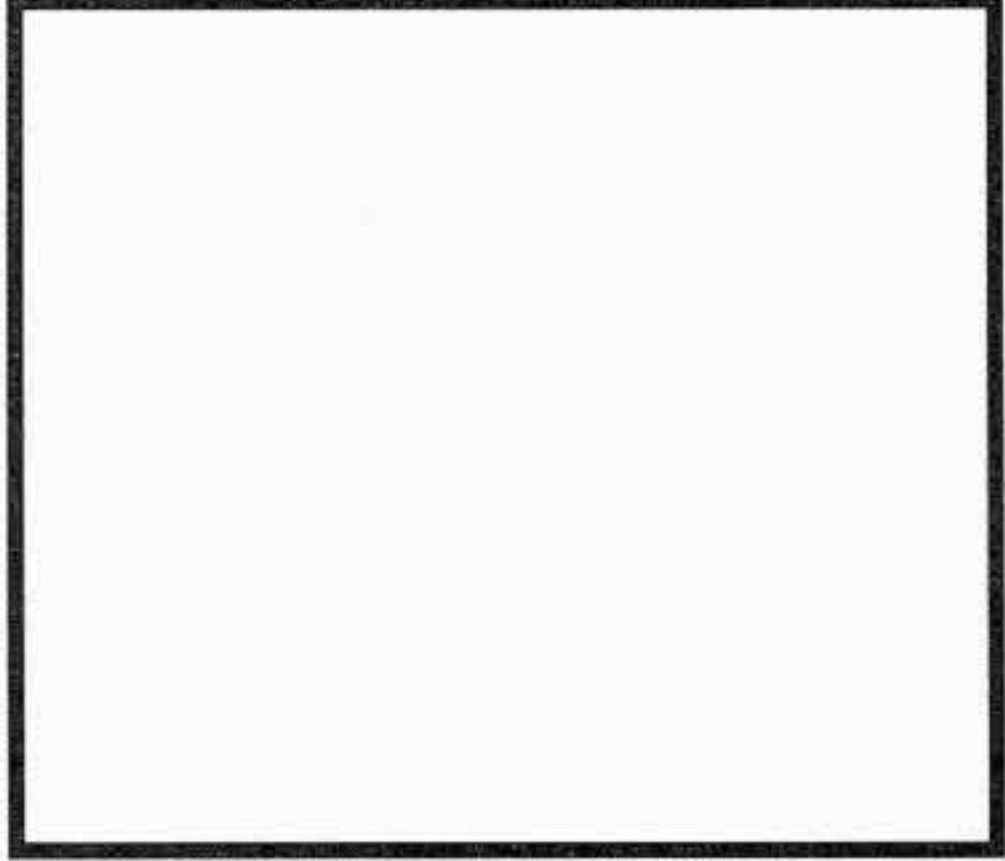
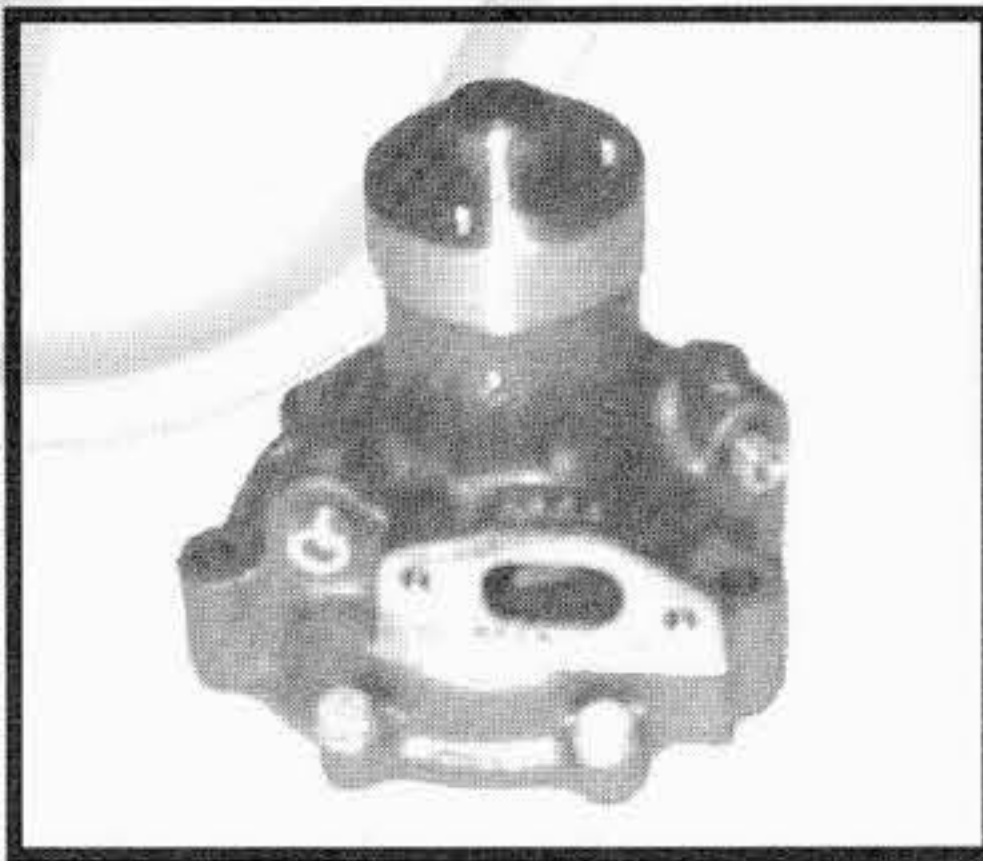
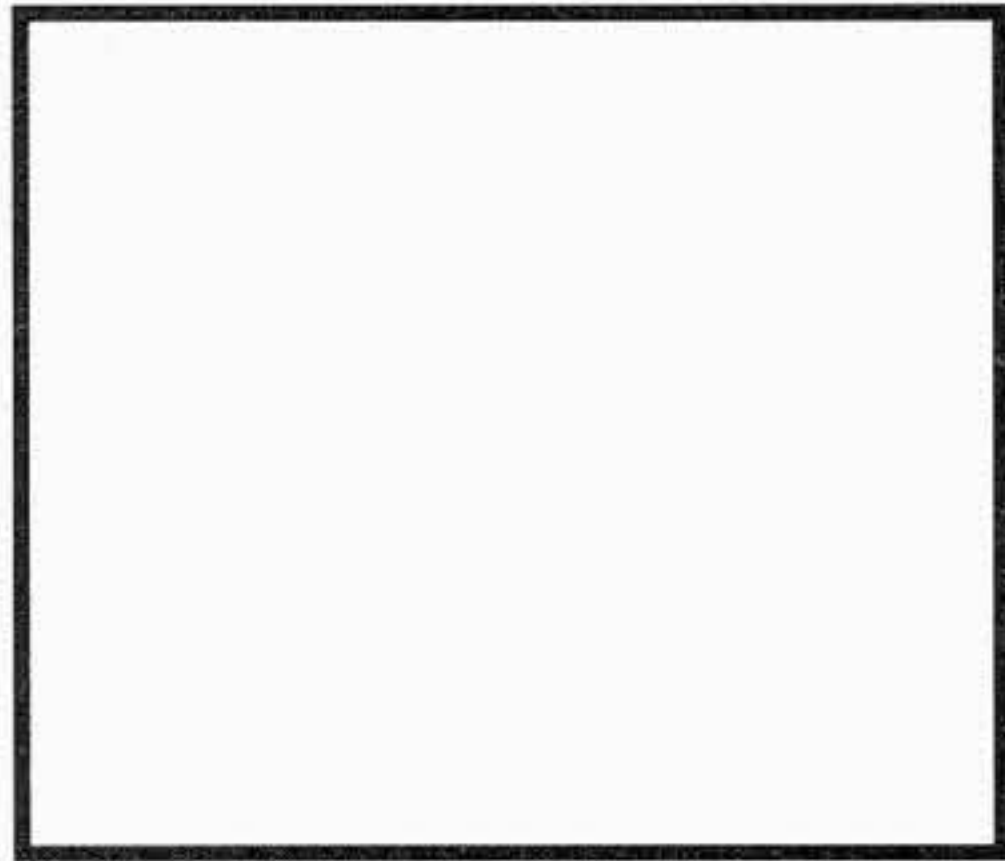
TIPO O MODELLO TYPE OU MODELE TYPE OR MODEL	MOTORE MOTEUR ENGINE	POMPA ACQUA POMPE A EAU WATER PUMP	KIT RIPARAZIONE NECESSAIRE DE REP. REPAIR KIT
		OMP REF. / O.EM. REF	OMP REF. / O.EM. REF
4	8035.02.210/310	<b>196.319</b> 93191101	<b>222.260</b> 76029352
FL4 C - FL4 D - FL4 L	261/265/361/365		
FL4 M ---> fino al telaio 400456	8035.04.265		
FD5 - FL5 ---> fino al telaio 201360	8045.04.189		
FB7 - FB7 C.M.	8045.04.293		
FD7 - FD7 B ---> fino al telaio 250904	8065.04.295		
FL7 ---> fino al telaio 250909	8065.04.295		
FR7 ---> fino al telaio 000440	8041 I 002		
FR9 ---> fino al telaio 00348	8051 I 000		
FR10 ---> fino al telaio 78Y00101	8065.24.091		
FE12 ---> fino al telaio 00124			
FE12 LC ---> fino al telaio 00053	8041 I 002 all.004		
FE12 MLC ---> fino al telaio 00033			
FE12 R ---> fino al telaio 00133	8041.04.300		
FR12	8065.24.092		
FE14 - FE16	8061 I 000		
FE16 ---> fino al telaio 00144	8061 I 000		
FE18 ---> fino al telaio 00480			
FE18 LC ---> fino al telaio 00095			
FE18 M ---> fino al telaio 00029	8065.04.097		
FE18 MLC ---> fino al telaio 00101			
FE18 R - FE18 RM--> fino al telaio 00177	8065.24.098		
S60	8041		
FG65 A	8041 I 002		
FL4 M dal telaio 400457 --->	8035.05.265	<b>206.265</b> 4813370	<b>222.264</b> 1940105
FD5 - FL5 dal telaio 201360 --->	8045.05.389		
FL5 B	8045.05.389		
FB7 B	8045.05.393		
FD7 - FD7 B dal telaio 250905 --->	8065.05.295		
FL7 dal telaio 250910 ---> - FL7 B	8065.05.295		
FR7 dal telaio 000441 --->	8041 I 05		
FR7 B - FR7 C	8045.05.395		
FD9	8065.25.095		
FR9 dal telaio 00349 --->	8051 I 05		
FD10 - FL10 E	8065.25.097 / 099		
FR10 dal telaio 78Y00102 --->	8065 SI 25.003		
FR10 B - FR10 C	8065.05.290		
FR11	8065.25.051-8060.25SI		
FE12 dal telaio 00125 ---> - FE12 L			
FE12 LC dal telaio 00054 --->	8041 I 05 all.004		
FE12 MLC dal telaio 00034 --->			
FE12 R dal telaio 00134 --->			
FE16 dal telaio 00145 --->	8051 I 05 all. 004		
FE18 dal telaio 00481 --->			
FE18 LC dal telaio 00096 --->			
FE18 M dal telaio 00030 --->	8065.05.097		
FE18 MLC dal telaio 00102 --->			
FA120	8065.25.096		
FH120 - FR130	8045SI25 all.001		
FH150 - FH150 3B	8045SI25 all.002		
FH200-FH200 LC-FH200 3B-FH200 EI	8065SI25 all.006		

I ricambi non sono originali ma adattabili . Ogni riferimento originale é assolutamente indicativo .



Spare parts are not original but perfectly suitable . Every original part number has to be considered for reference purpose only .

SUITABLE

# NEW HOLLAND

FIAT ALLIS  
FIATHITACHI  
SIMIT

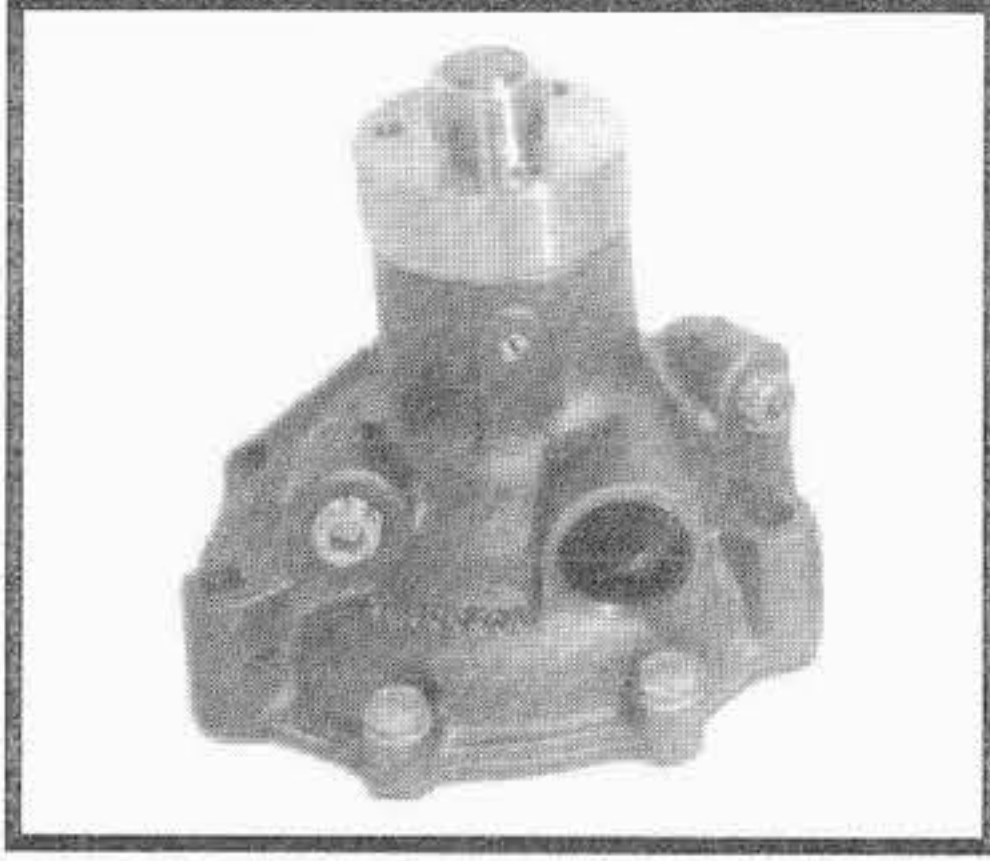

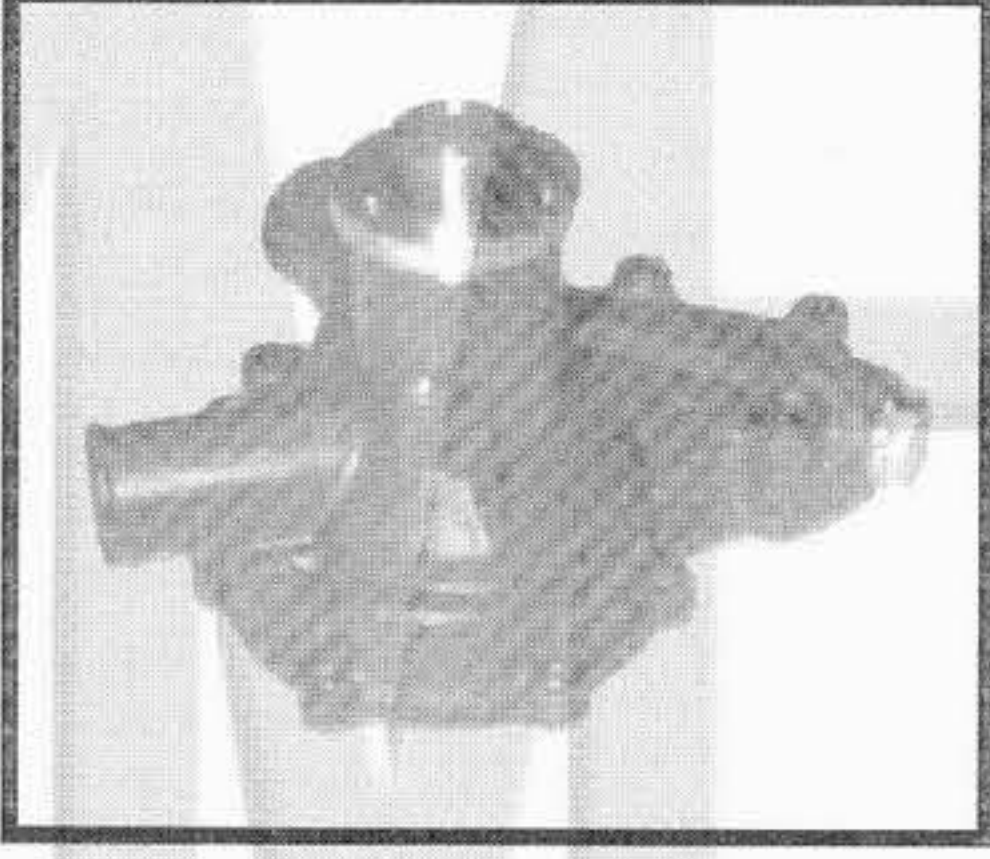
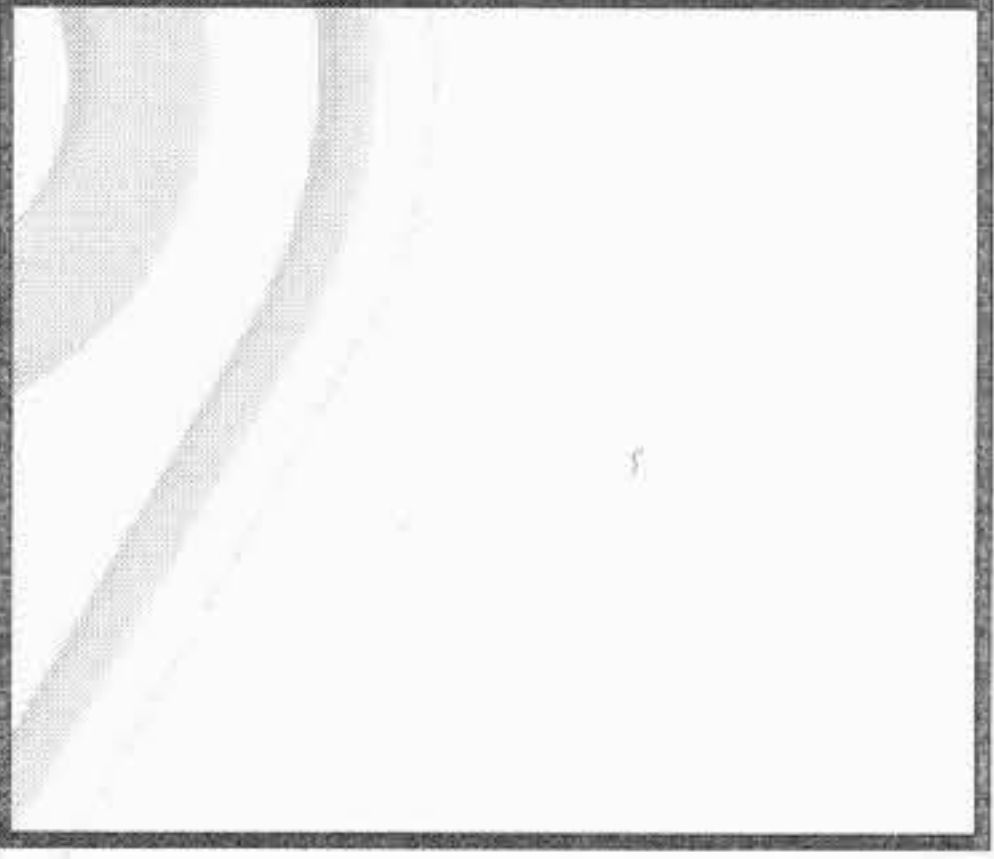
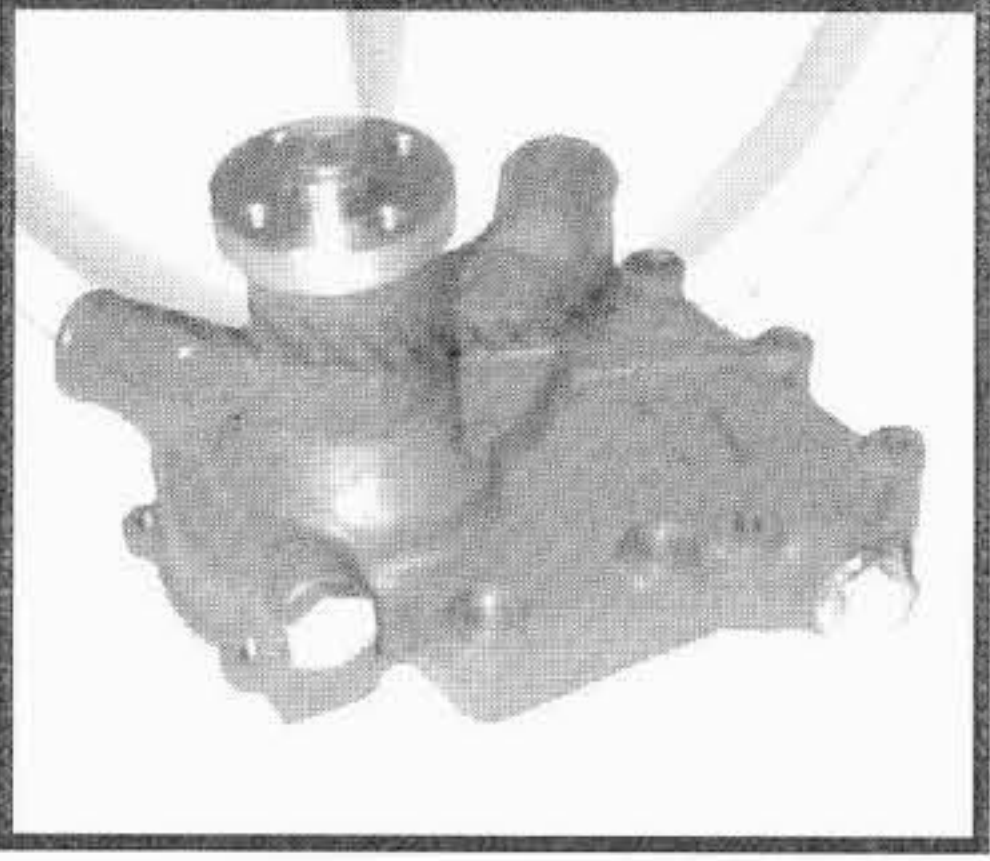
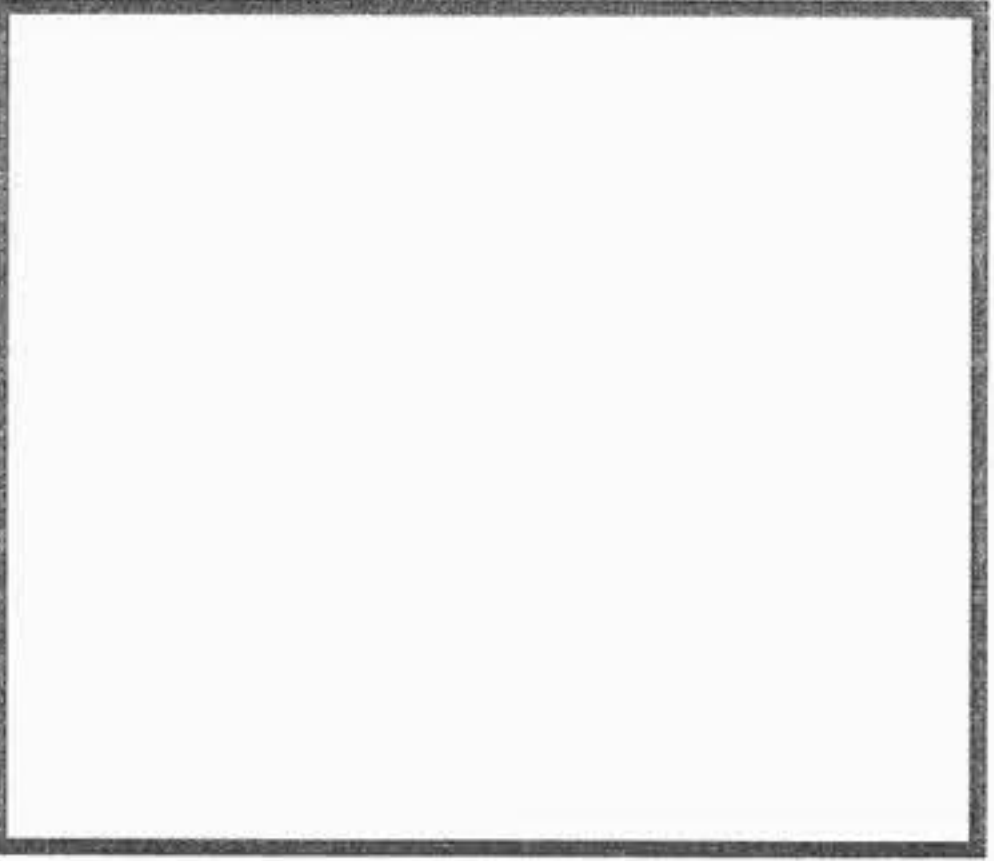
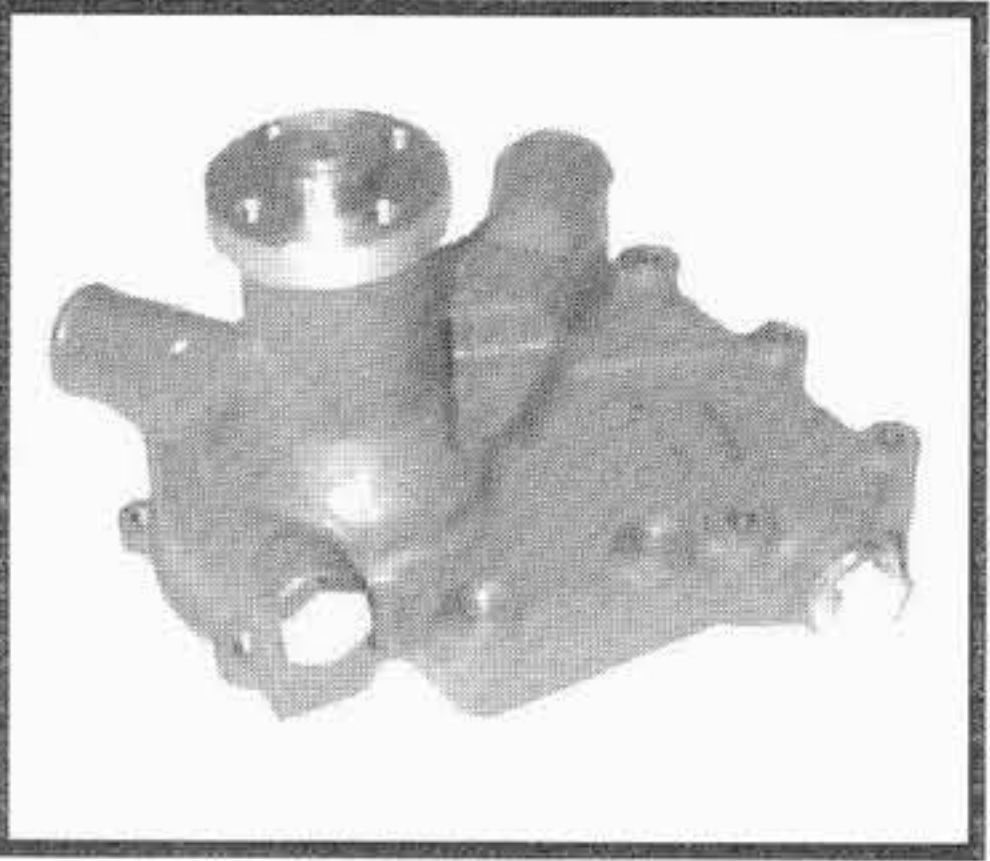
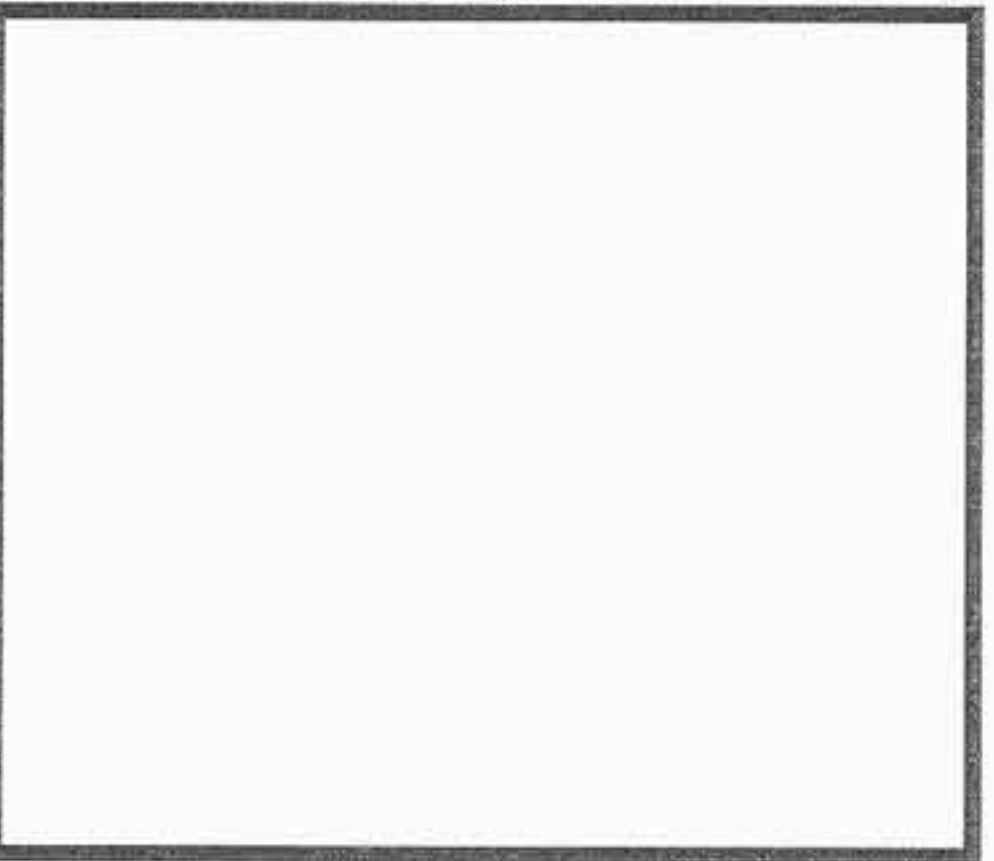
TIPO O MODELLO TYPE OU MODELE TYPE OR MODEL	MOTORE MOTEUR ENGINE	POMPA ACQUA POMPE A EAU WATER PUMP	KIT RIPARAZIONE NECESSAIRE DE REP. REPAIR KIT
		OMP REF. / O.EM. REF	OMP REF. / O.EM. REF
FL4 M FD5 - FL5 - FL5 B FB7 B FD7 - FD7 B - FL7 - FL7 B FR7 FR7 B - FR7 C FD9 FR9 FD10 - FL10 E FR10 FR10 B - FR10 C FR11 FE12 - FE12LC - FE12MLC - FE12L - FE12R FE16 FE18 - FE18 LC - FE18 M - FE18 MLC FA120 FH120 - FR130 FH150 - FH150 3B FH200 - FH200 LC - FH200 3B - FH200 EI tutti i modelli / all models <b>01 / 93</b> --->	8035.05.265 8045.05.389 8045.05.393 8065.05.295 8041 I 05 8045.05.395 8065.25.095 8051 I 05 8065.25.097 / 099 8065 SI 25.003 8065.05.290 8065.25.051-8060.25SI 8041 I 05 all.004 8051 I 05 all. 004 8065.05.097 8065.25.096 8045 SI 25 all. 001 8045 SI 25 all. 002 8065 SI 25 all. 006	<p><b>226.334</b> 98497117</p> 	<p><b>222.264</b> 1940105</p> 
5  FL6  S70 I - S70 M - SR70 - S90	CN3 var. 11 / .13  CO3/60 var.10/11/12  CO3/60	<p><b>221.485</b> 8829787</p> 	<p><b>222.262</b> 76031329</p> 
7 C  FL8 C  9	CO3.130MTvar.2/10  CO3.130MT  CP3/100 var. 3/4 var.13.300	<p><b>201.955</b> 4757340</p> 	<p><b>222.267</b> 76032963</p> 
7 D  S9 - SL9 - SR9  S11 - SL11	CO3.130MT var.14.300  CO3.130 var.2  CO3.130 var.2	<p><b>201.935</b> 4757341</p> 	<p><b>222.016</b> 79046187</p> 





I ricambi non sono originali ma adattabili . Ogni riferimento originale é assolutamente indicativo .  
 Spare parts are not original but perfectly suitable . Every original part number has to be considered for reference purpose only .

SUITABLE

**NEW HOLLAND**

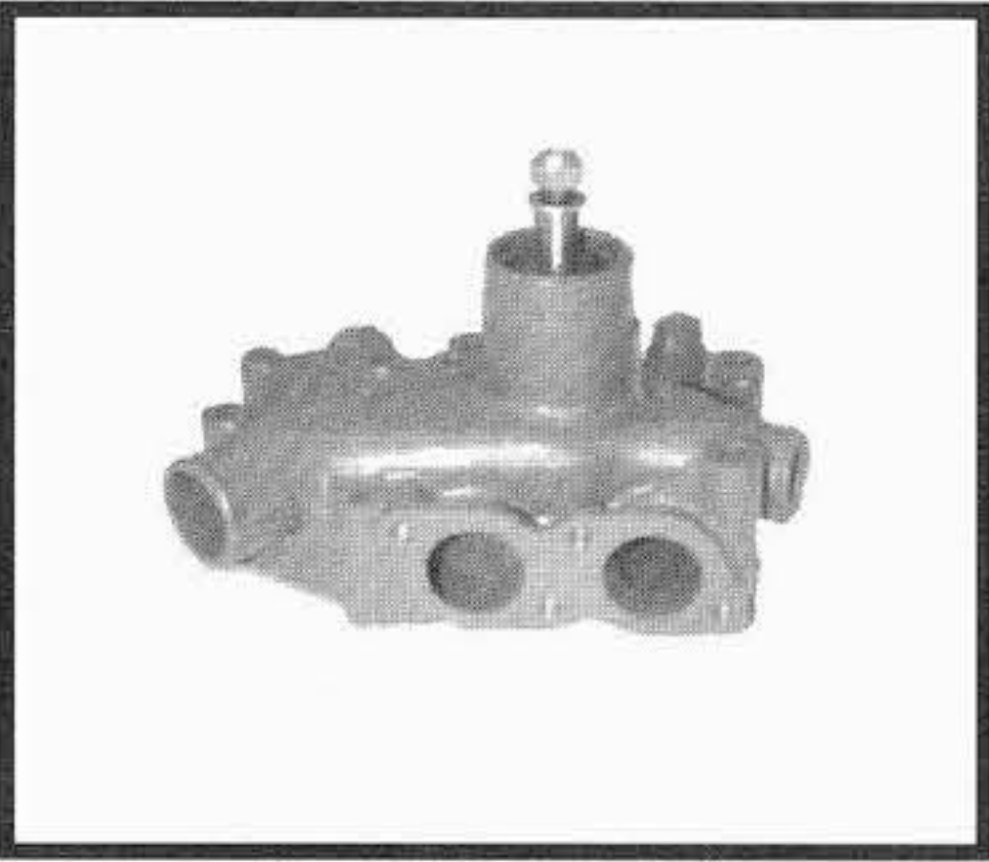
**FIAT ALLIS  
FIATHITACHI  
SIMIT**

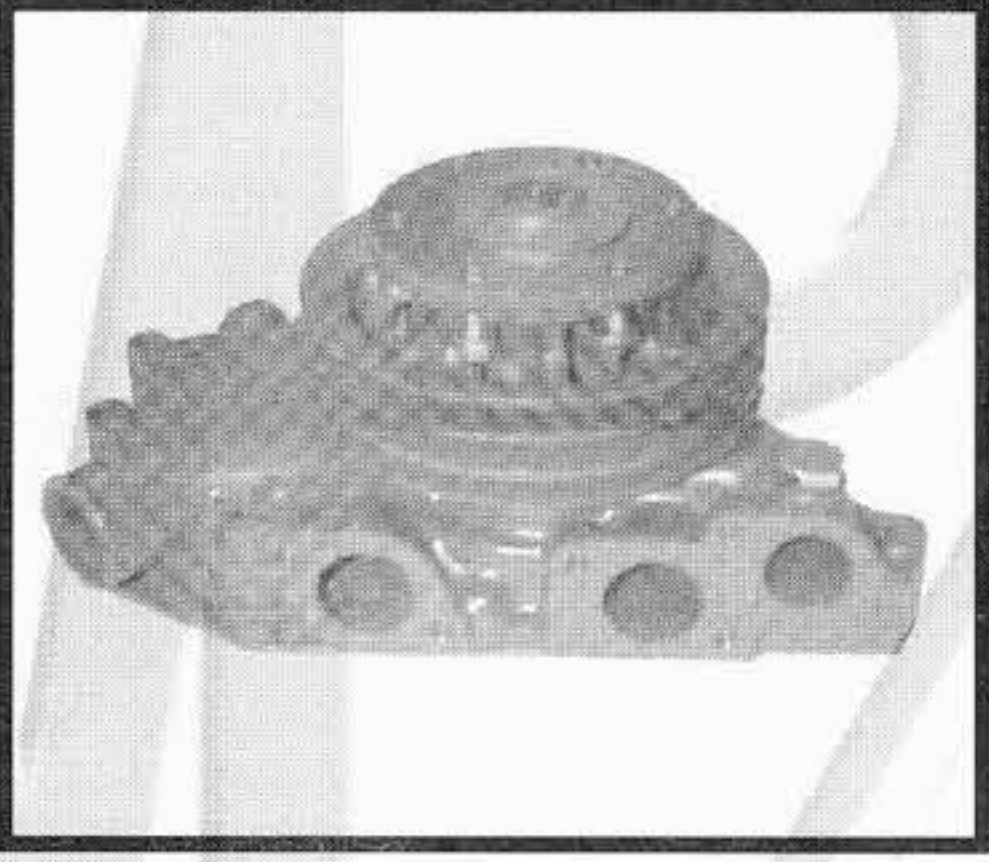
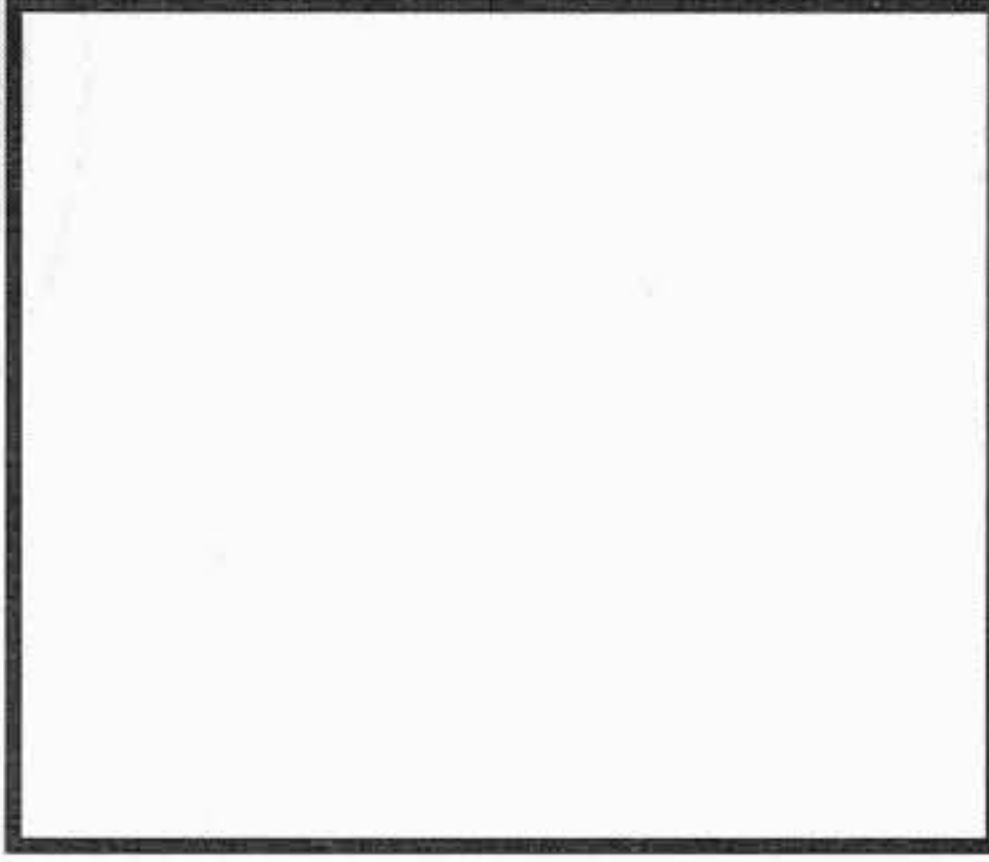
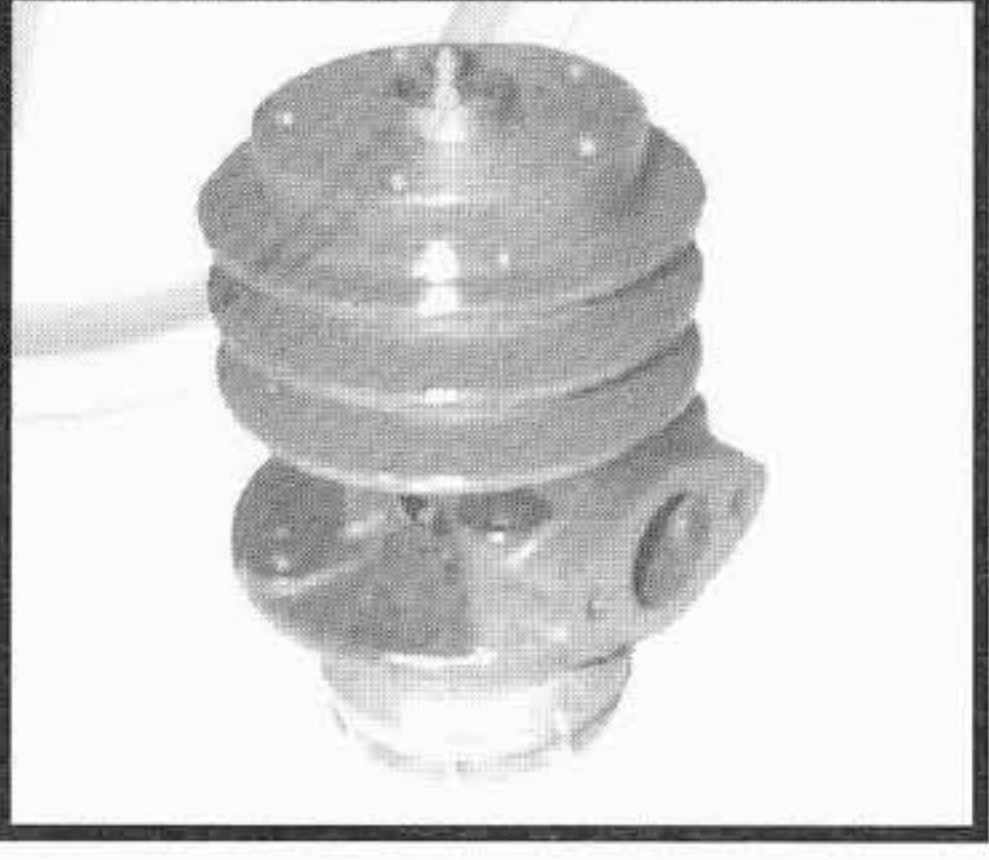

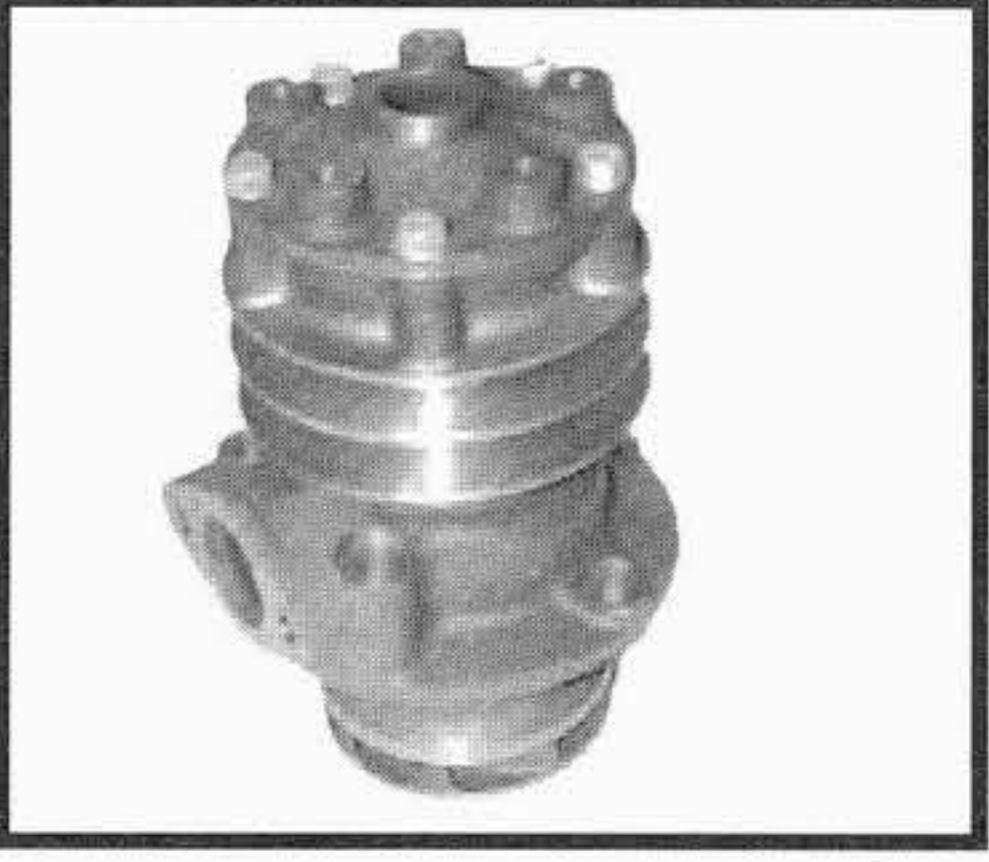
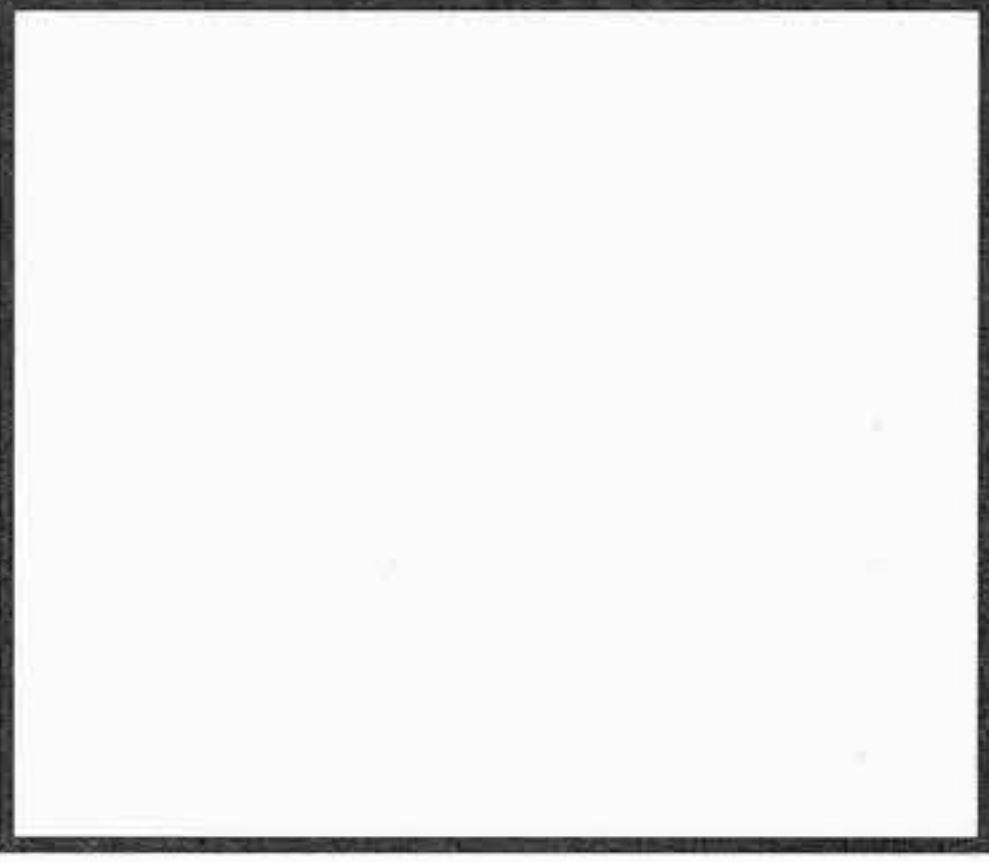
TIPO O MODELLO TYPE OU MODELE TYPE OR MODEL	MOTORE MOTEUR ENGINE	POMPA ACQUA POMPE A EAU WATER PUMP	KIT RIPARAZIONE NECESSAIRE DE REP. REPAIR KIT
		OMP REF. / O.EM. REF	OMP REF. / O.EM. REF
8 - 8 B  FL9  10 B  FL10 - FL10 B	CO3.130MT var.11 / .12  CO3.130MT var 1.300 / .800  CP3.100var.1/.2  CP3/100 - 300	<b>201.606</b> 8829780  	<b>202.271</b> 76032964  
8 B var. 300022071  FL9 var. 300022071	CO3.130MT var.11.800  CO3.130MT	<b>206.270</b> 4698554  	--- ---  
FL8	604.032/.033 --> fino al mot.084045	<b>201.590</b> 586017 CON PULEGGIA / WITH PULLEY    <b>201.585</b> --- SENZA PULEGGIA / WITHOUT PULLEY	<b>202.051</b> ---  
FL8	604.032 / .033 dal mot. 084046 -->	<b>201.596</b> 4629940 CON PULEGGIA / WITH PULLEY    <b>201.595</b> --- SENZA PULEGGIA / WITHOUT PULLEY	<b>222.056</b> 79046180  

I ricambi non sono originali ma adattabili . Ogni riferimento originale é assolutamente indicativo .  
Spare parts are not original but perfectly suitable . Every original part number has to be considered for reference purpose only .



SUITABLE







**NEW HOLLAND**

**FIAT ALLIS  
FIATHITACHI**

**Tel:+44(0)1925 850082 Fax: +(0)44 1925 850083**

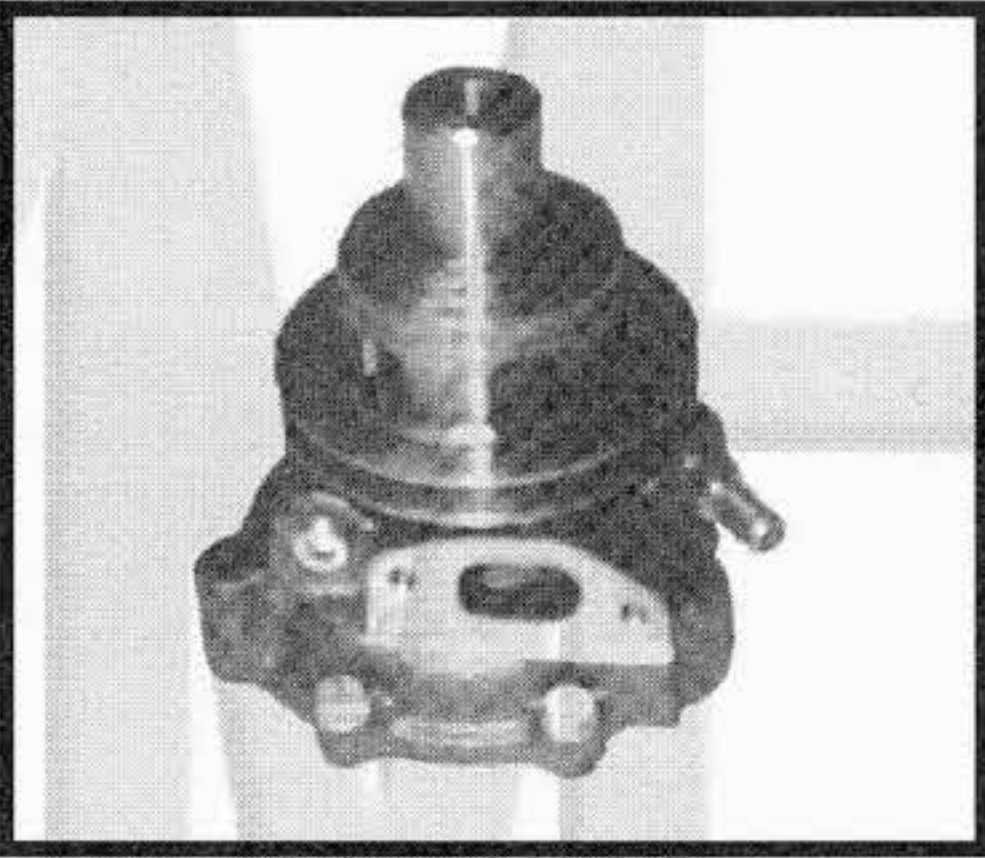
**www.spwaterpumps.co.uk**

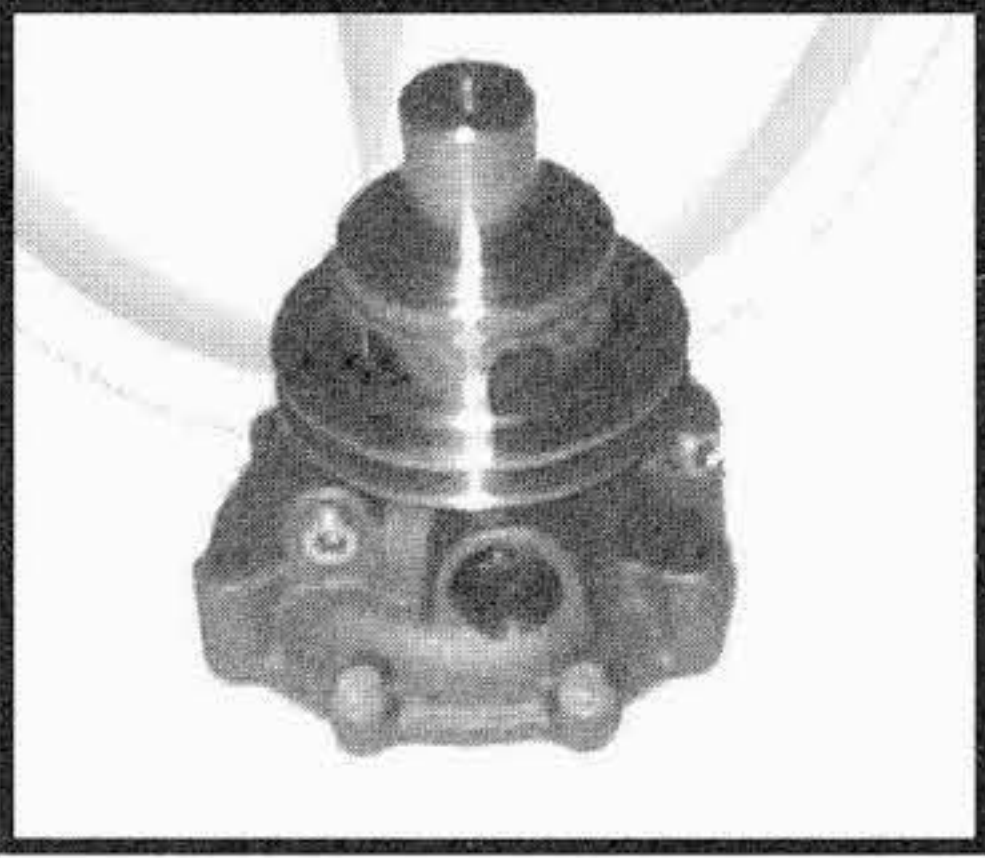

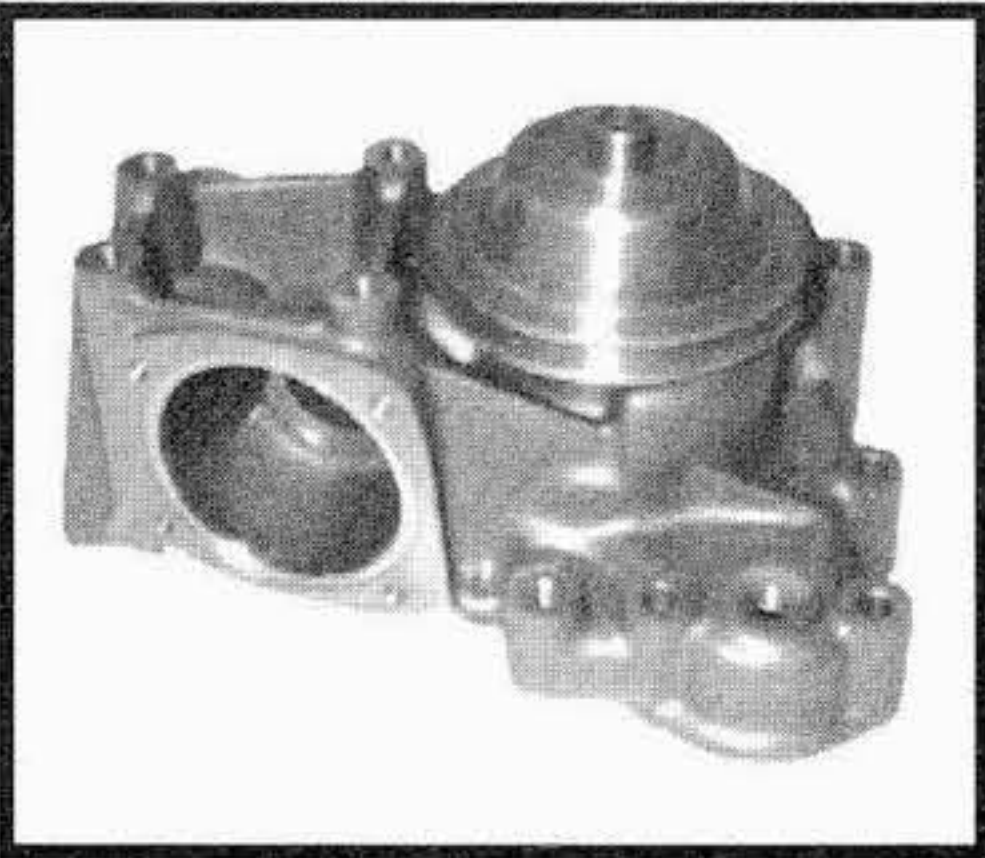
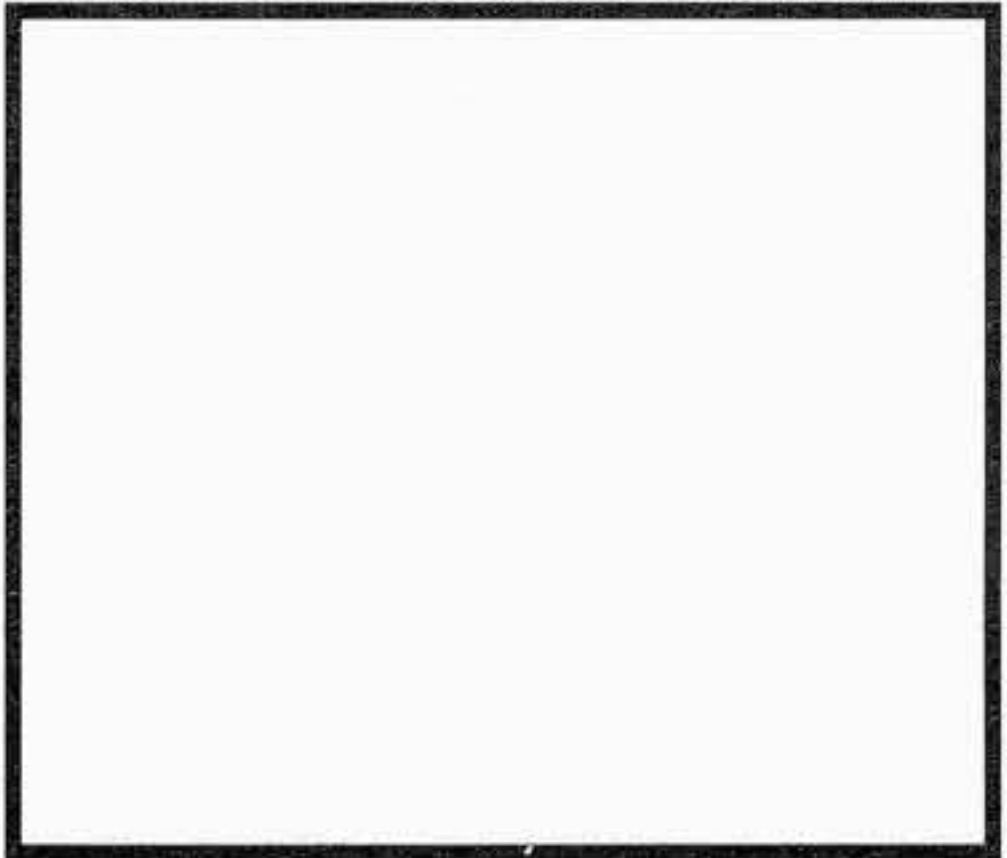
TIPO O MODELLO TYPE OU MODELE TYPE OR MODEL	MOTORE MOTEUR ENGINE	POMPA ACQUA POMPE A EAU WATER PUMP	KIT RIPARAZIONE NECESSAIRE DE REP. REPAIR KIT
		OMP REF. / O.EM. REF	OMP REF. / O.EM. REF
FR9 / B	CO3.130MT var. 20	<p><b>201.920</b> 8830732</p> 	<p><b>222.128</b> 79046181</p> 
FR9 B FR9 C ---> 1996	8045.25.395	<p><b>206.380</b> 4817651</p> 	<p><b>222.253</b> ---</p> 
FR9 B FR9 C 1997 --->	8045.25.395	<p><b>226.551</b> 99454834</p> 	<p><b>222.253</b> ---</p> 
10 C - 10 CTA - 10 LGP FL10 C FD14 - FD14 E FL14 E FR15 - FR15 B FE20 / LC / HD / M / MLC / MHD FE24 FE28 / LC / HD / M / MLC / MHD FP40 FG75 - FG85 - FG95 FA150 FH220 - FH220 LC - FH220 3B FH300 - FH300 T	8365.05.570/573/577 8365.05.560 8365SI - 8365.25.541 8365.25.540 8365.580 / .583 8365.05.530 8365.05.531 8365.25.530/.531 8365.25.541 8365 8365.25.542/ 543 8365 SI 11 all.010 8365 SI 11 all.011	<p><b>206.435</b> 98410023</p> 	<p><b>222.263</b> 76030102</p> 

I ricambi non sono originali ma adattabili . Ogni riferimento originale é assolutamente indicativo .  
Spare parts are not original but perfectly suitable . Every original part number has to be considered for reference purpose only .

SUITABLE







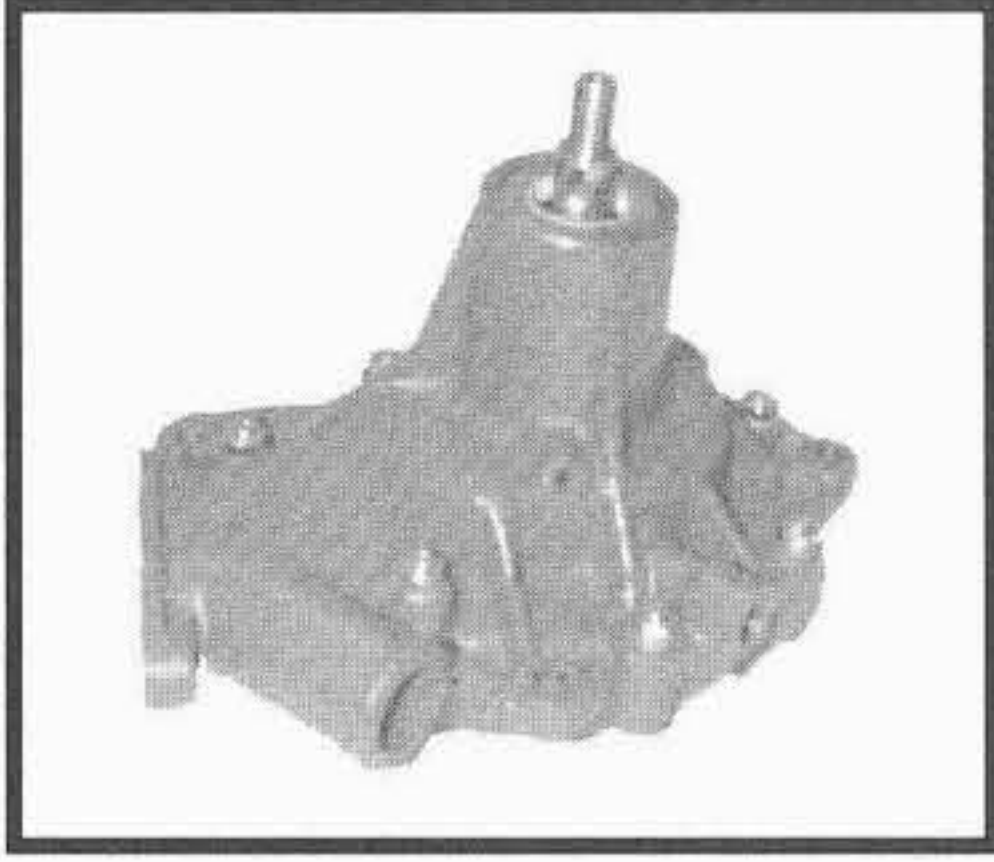

**NEW HOLLAND**

**FIAT ALLIS  
FIATHITACHI**

**Tel:+44(0)1925 850082 Fax: +(0)44 1925 850083**

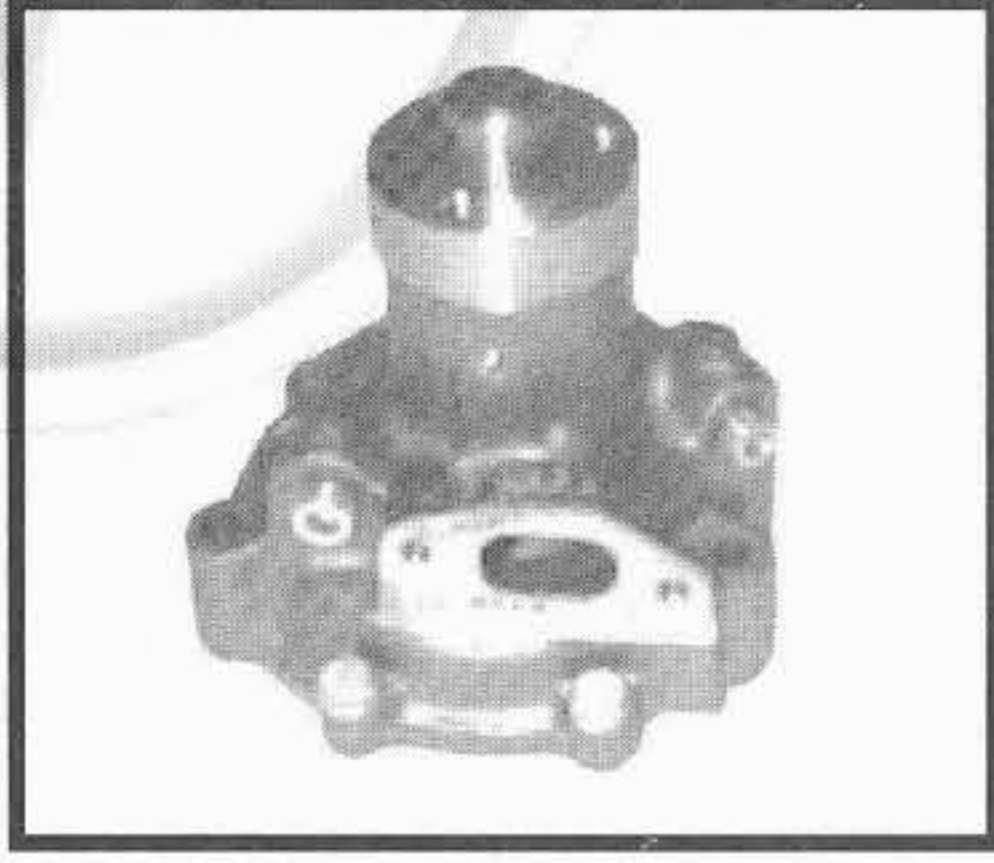
**www.spwaterpumps.co.uk**



TIPO O MODELLO TYPE OU MODELE TYPE OR MODEL	MOTORE MOTEUR ENGINE	POMPA ACQUA POMPE A EAU WATER PUMP	KIT RIPARAZIONE NECESSAIRE DE REP. REPAIR KIT
FL12	220 ---> fino al mot. 0001558	<p><b>191.280</b> 4613395</p> 	<p><b>192.012</b> ---</p> 
<p>FL12</p> <p>AD-BD14 - AD14 L - BD14 - 14 B</p> <p>FL14 - FL14 B</p> <p>S15 B ---&gt; fino alla matr. 24/159 S15 BHD ---&gt; fino alla matr. 38/096 SLC15 B ---&gt; fino alla matr. 29/022</p> <p>20</p>	<p>8205.02 dal mot. 0001559 ----&gt;</p> <p>8205.02.511/.513</p> <p>8205.02.500/.501</p> <p>8205 I all. 005</p> <p>8215.02.513/.515</p>	<p><b>201.965</b> 4952496</p> 	<p><b>202.270</b> 76031213</p> 
<p>FR12 B</p> <p>FE18 R dal telaio 00178 ---&gt; FE18 RM</p> <p><b>tutti i modelli / all models ---&gt; 12/92</b></p>	<p>8065.25.092</p> <p>8065.25.098</p>	<p><b>206.295</b> 4813371</p> 	<p><b>222.264</b> 1940105</p> 
<p>FR12 B</p> <p>FE18 R dal telaio 00178 ---&gt; FE18 RM</p> <p><b>tutti i modelli / all models 01/93 ---&gt;</b></p>	<p>8065.25.092</p> <p>8065.25.098</p>	<p><b>226.338</b> 98497118</p> 	<p><b>222.264</b> 1940105</p> 

I ricambi non sono originali ma adattabili . Ogni riferimento originale é assolutamente indicativo .

Spare parts are not original but perfectly suitable . Every original part number has to be considered for reference purpose only .

SUITABLE





**NEW HOLLAND**

**FIAT ALLIS  
FIATHITACHI**

**Tel:+44(0)1925 850082 Fax: +(0)44 1925 850083**

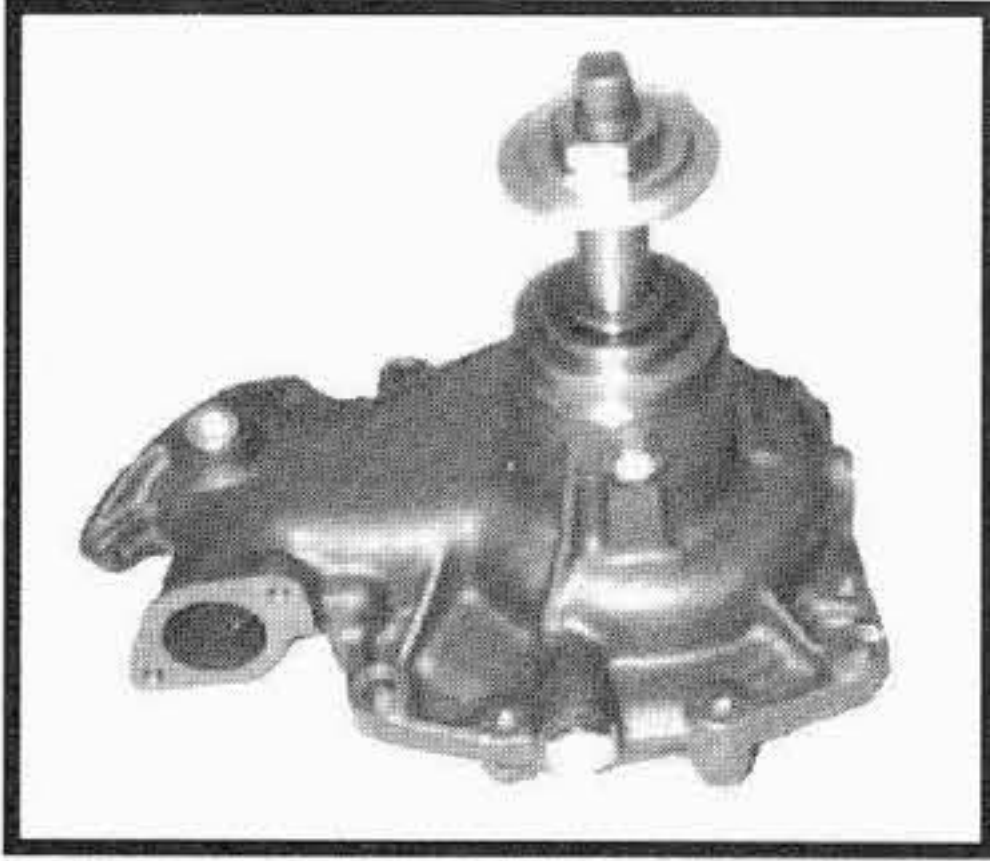
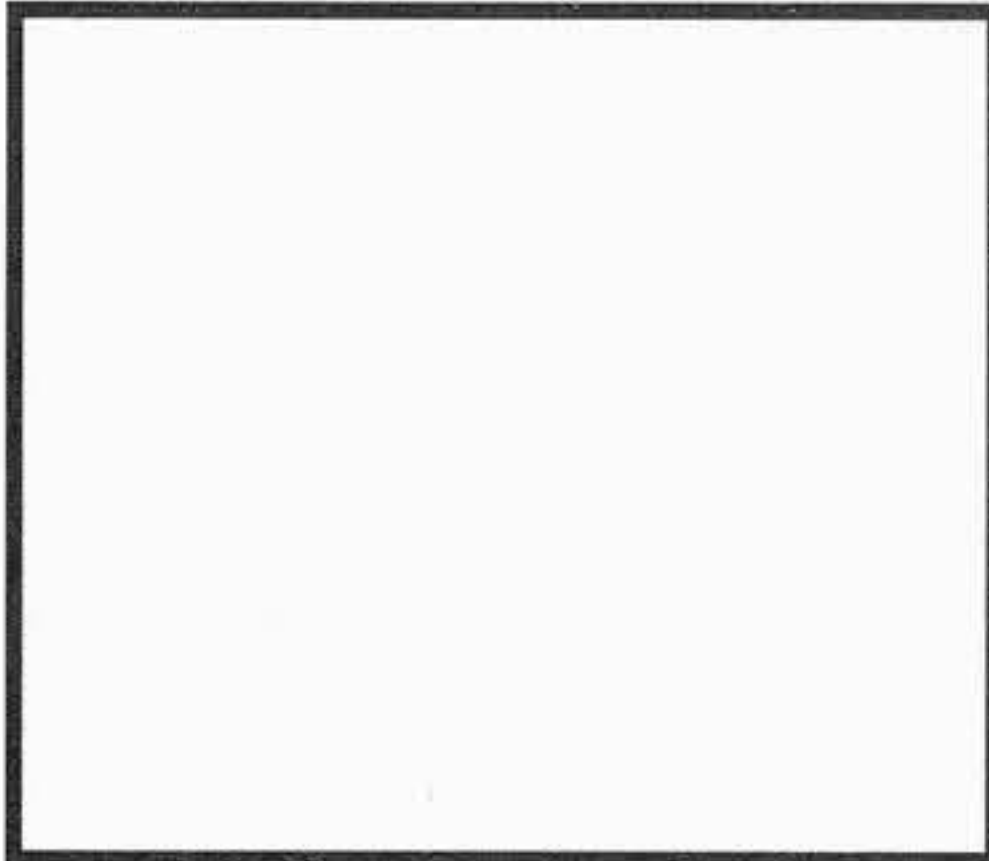
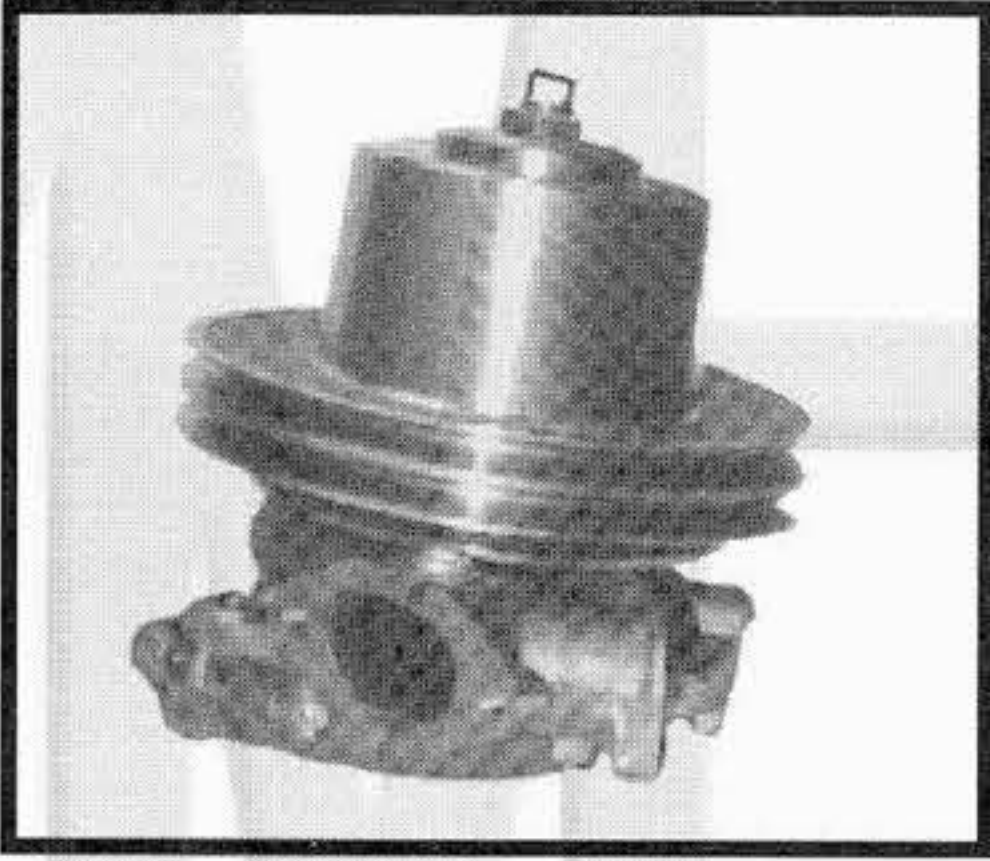
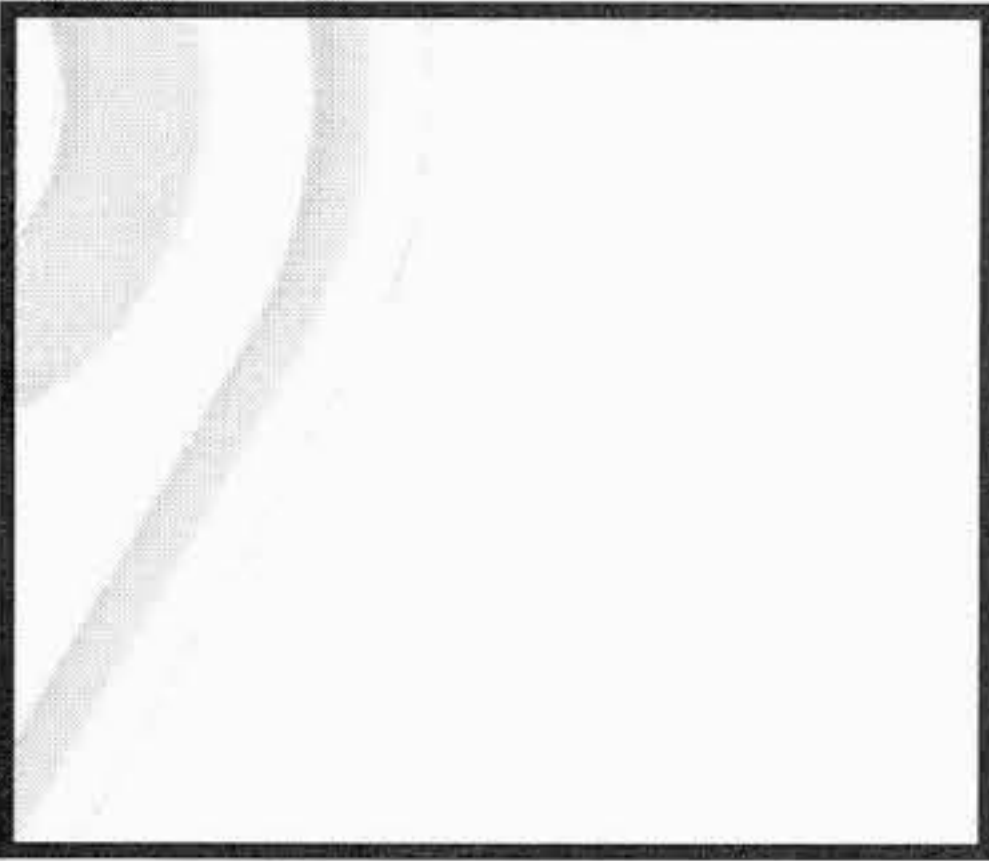
**www.spwaterpumps.co.uk**

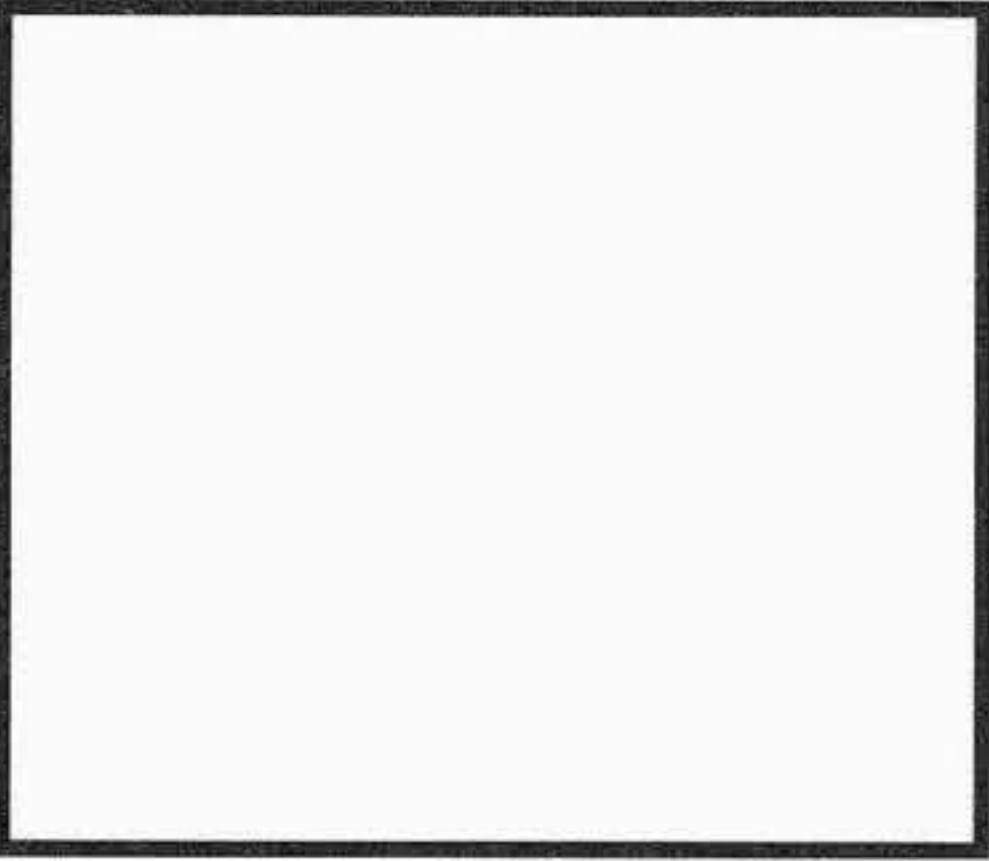
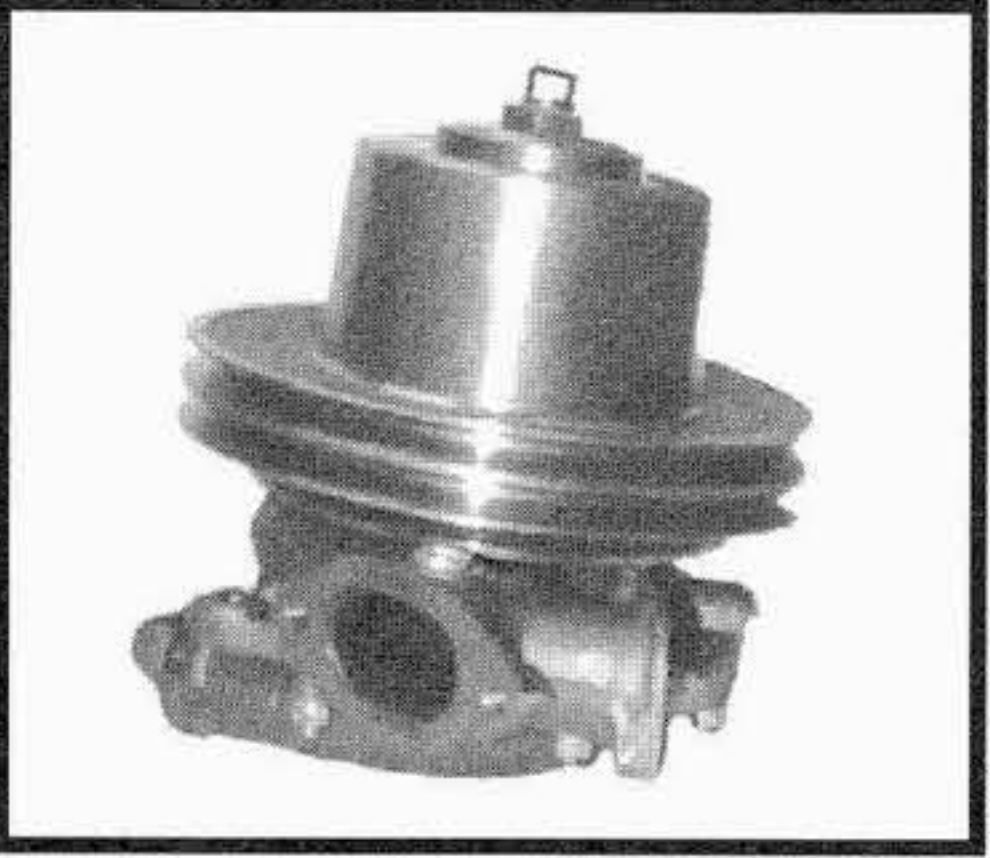

TIPO O MODELLO TYPE OU MODELE TYPE OR MODEL	MOTORE MOTEUR ENGINE	POMPA ACQUA POMPE A EAU WATER PUMP OMP REF. / O.EM. REF	KIT RIPARAZIONE NECESSAIRE DE REP. REPAIR KIT OMP REF. / O.EM. REF
14 C - 14 C LGP - 14 CTA  FL14 C  S15 B dalla matr. 24 / 160 ---> S15 BHD dalla matr. 38 / 097 ---> SLC15 B dalla matr. 29 / 023 --->  FD20  FL20	8205.02.513/.533  8205.02.520  8205 I all. 005  8215.22.520/.531 ---> fino al mot. 004274  8215.22.520 ---> fino al mot. 004274	201.960 79014642  	202.269 76032967  
FD20  FL20  FD20-2	8215.22.520/.531 dal mot. 004275 --->  8215.22.520 dal mot. 004275 --->  8215.22.520	201.975 4758190  	202.273 76032966  
FD14  FL14 D - FL14 D E.I.  FL20  FE40 - FE40 L - FE40 FS  FP40  FE45  FA200	8205.03.500/.531  8205.03.531  8215.22.520 dal mot. 007096 --->  8215.22.523  8205.03.531  8215 SI all.008  8215 I 006	206.010 4761615  	202.273 76032966  
FR20 - FR20 B	8215.02.542	201.985 4758191  	202.273 76032966  

I ricambi non sono originali ma adattabili . Ogni riferimento originale é assolutamente indicativo .  
 Spare parts are not original but perfectly suitable . Every original part number has to be considered for reference purpose only .

SUITABLE





**NEW HOLLAND**

**FIAT ALLIS  
FIATHITACHI**

Tel: +44(0)1925 850082 Fax: +(0)44 1925 850083

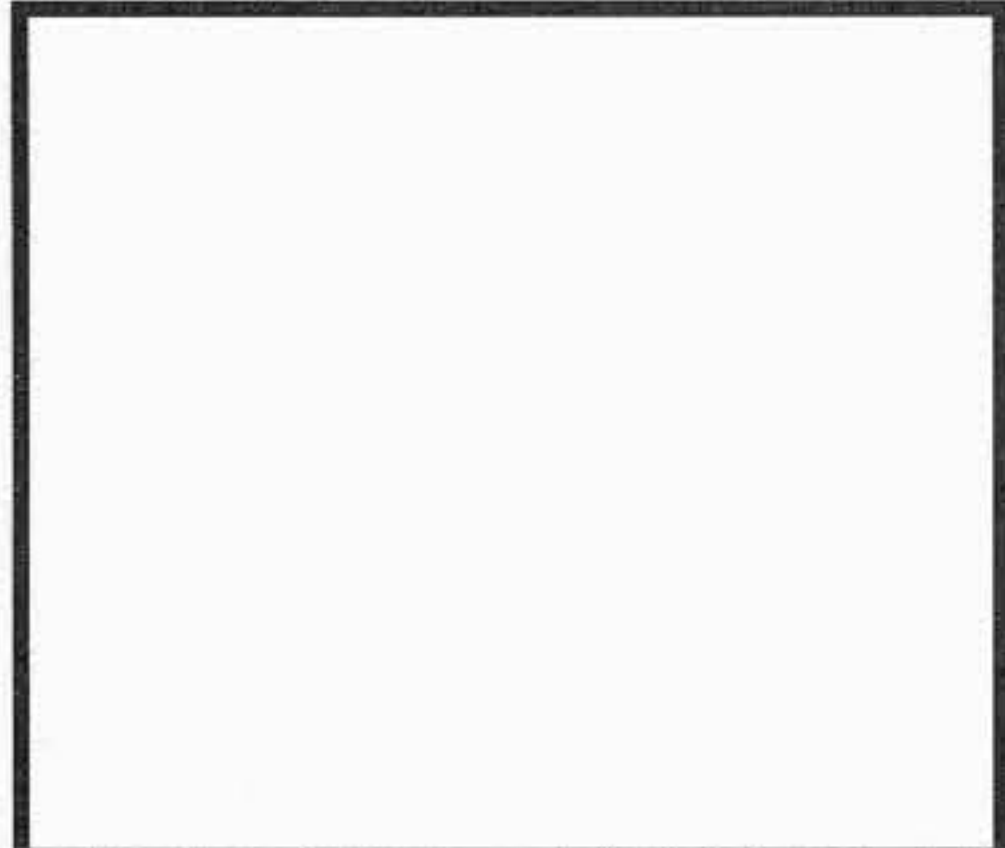
www.spwaterpumps.co.uk

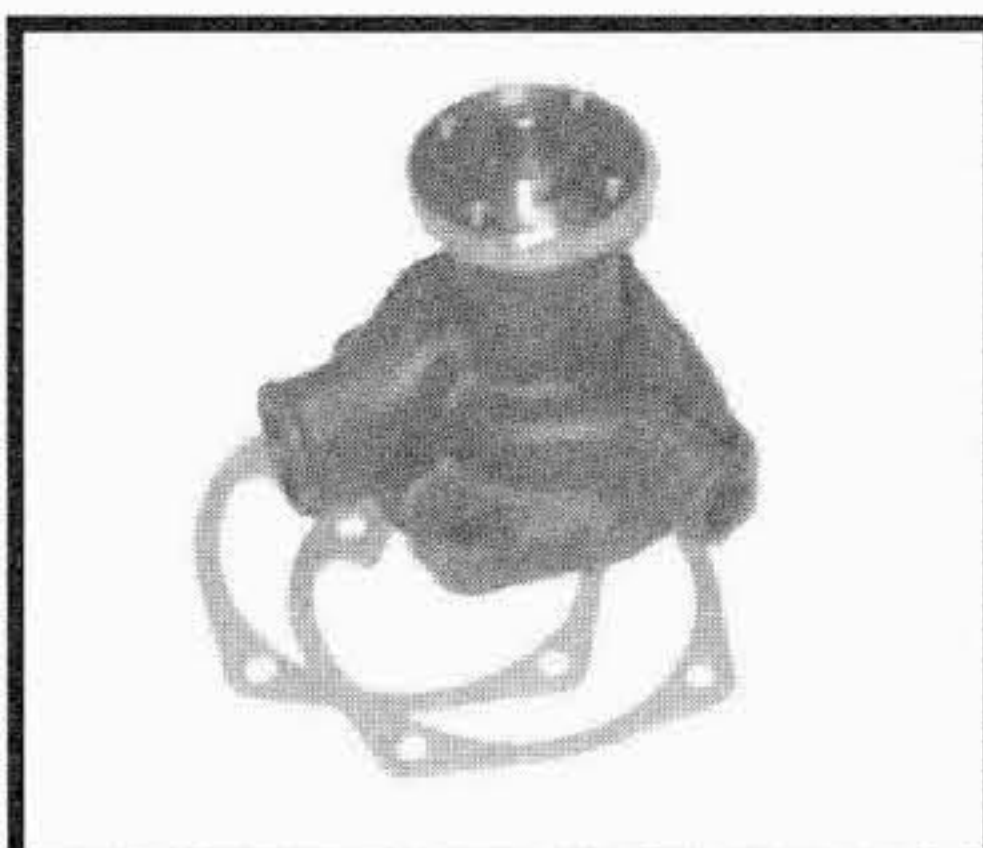
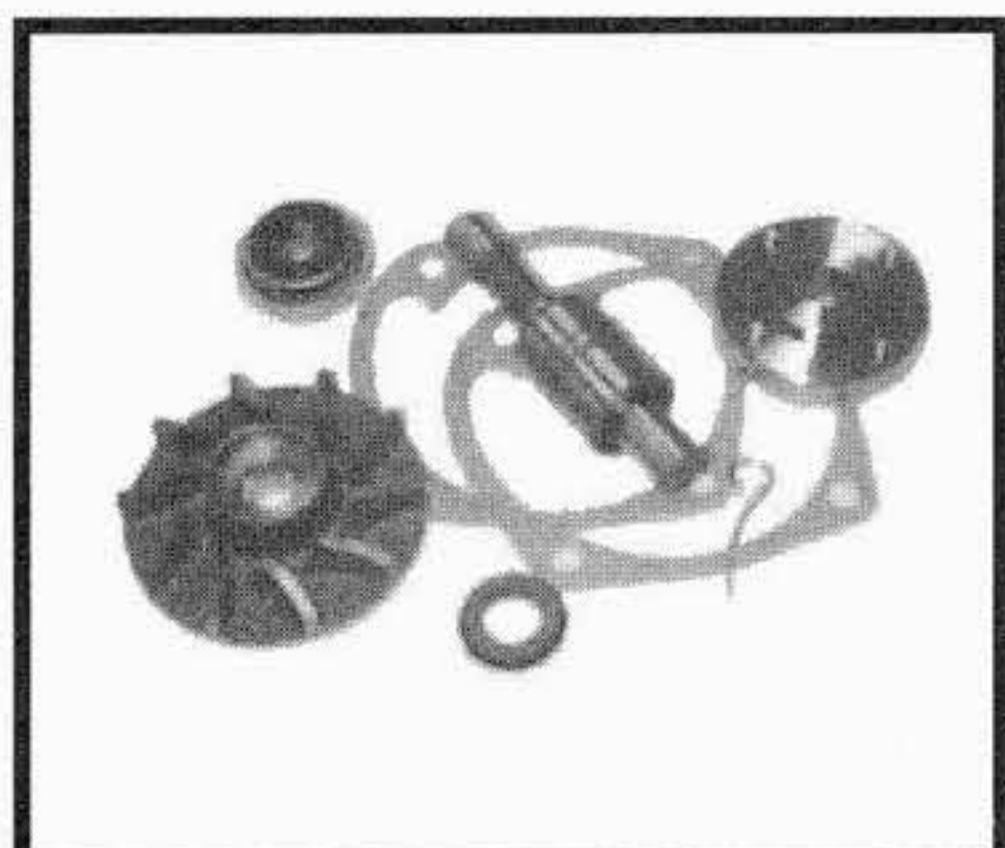

TIPO O MODELLO TYPE OU MODELE TYPE OR MODEL	MOTORE MOTEUR ENGINE	POMPA ACQUA POMPE A EAU WATER PUMP	KIT RIPARAZIONE NECESSAIRE DE REP. REPAIR KIT
		OMP REF. / O.EM. REF	OMP REF. / O.EM. REF
FD30 / HA / HUI / HSU / HR  FD30 B - FD30 C  FR35	8285  8285.22.004  8285	196.015 4764156  	202.272 76032965  
65 B	8065.04.089	196.327 4723063  	222.141 79046185  
65 B	8061105.000	206.205 8107660  	222.253 ---  
FA100	MWM D229 / 6cyl.	203.160 1756186  	202.090 ---  

I ricambi non sono originali ma adattabili . Ogni riferimento originale é assolutamente indicativo .  
Spare parts are not original but perfectly suitable . Every original part number has to be considered for reference purpose only .

SUITABLE



**NEW HOLLAND**

**FIAT ALLIS  
FIATHITACHI**

**Tel: +44(0)1925 850082 Fax: +(0)44 1925 850083**

**www.spwaterpumps.co.uk**

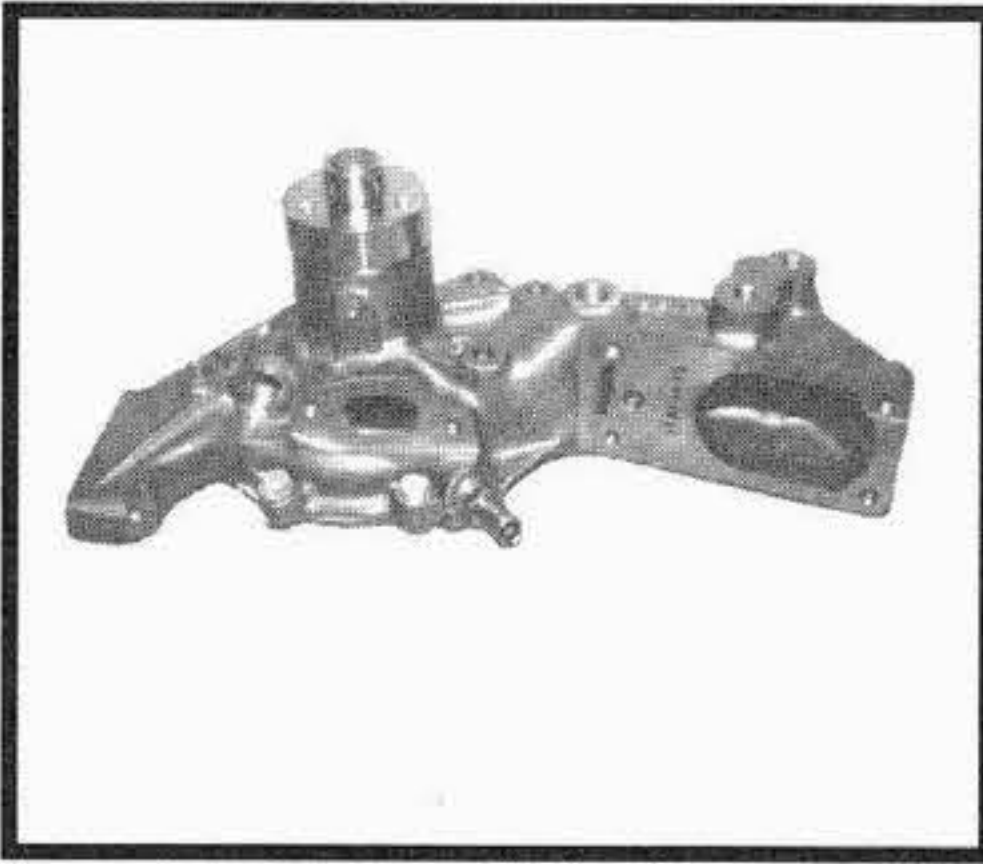
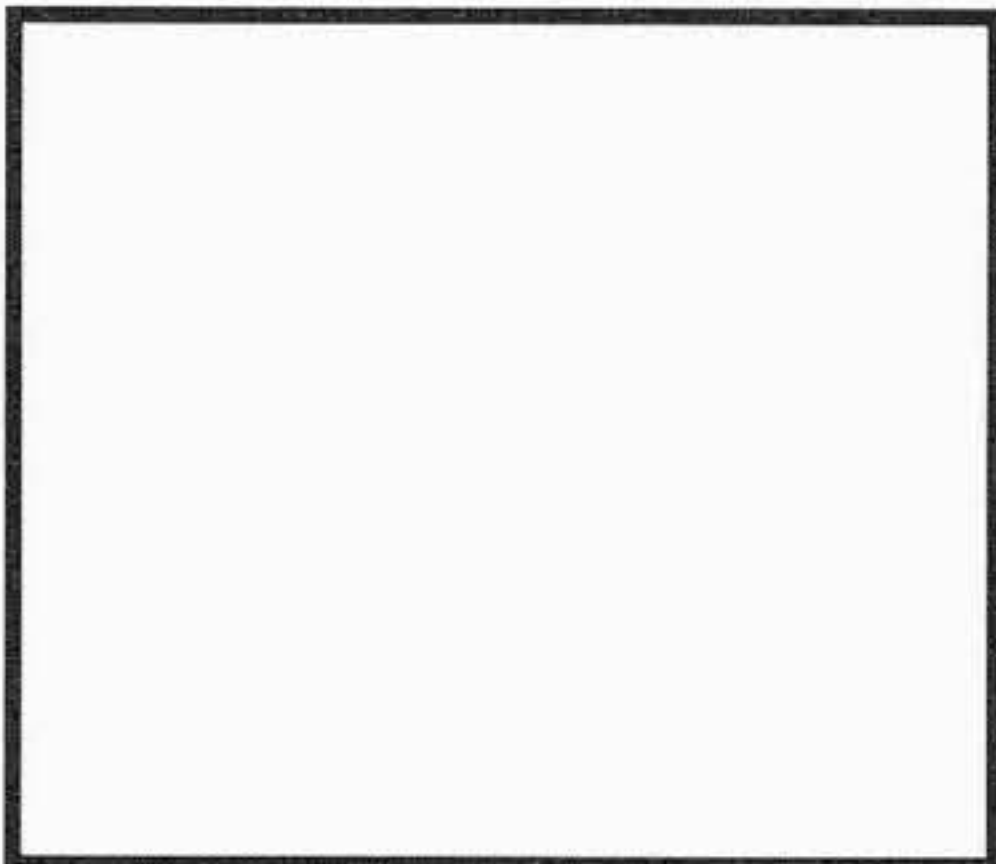
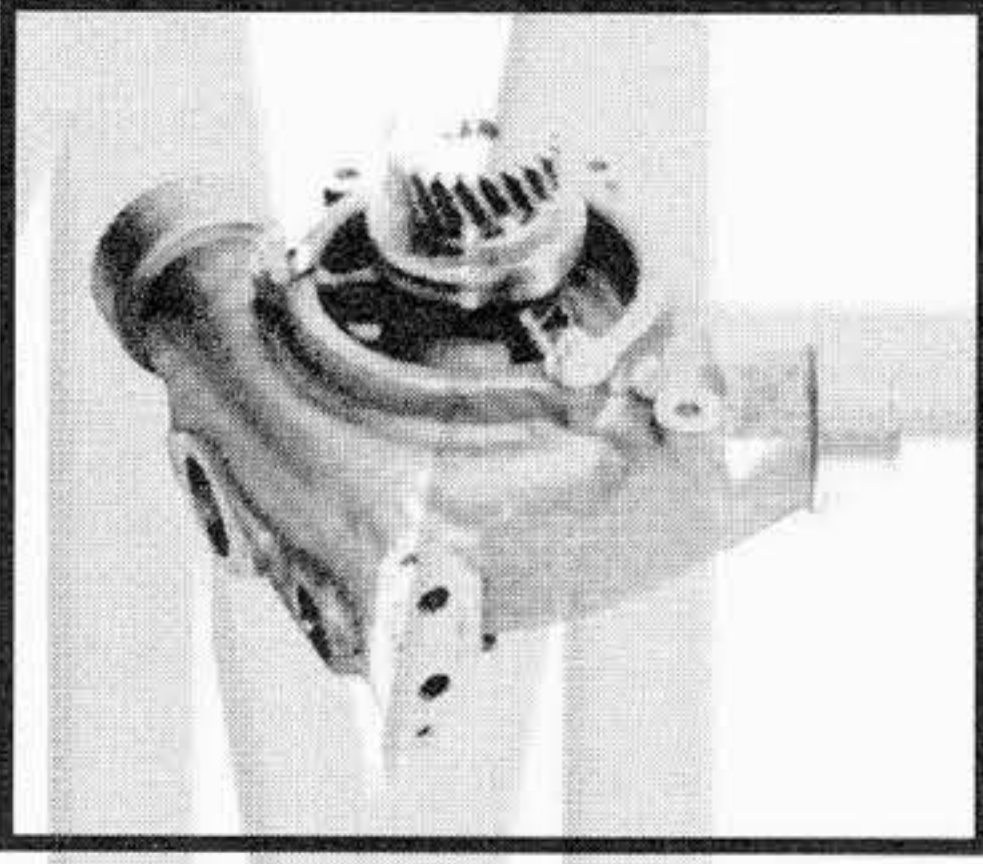
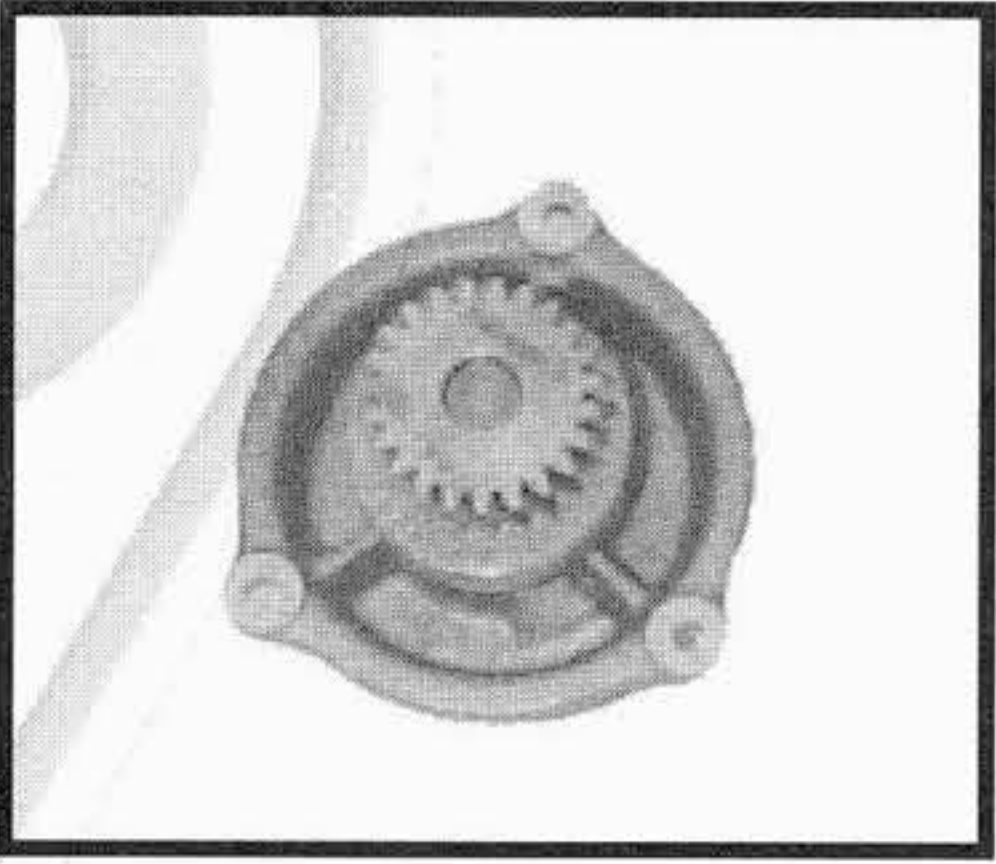

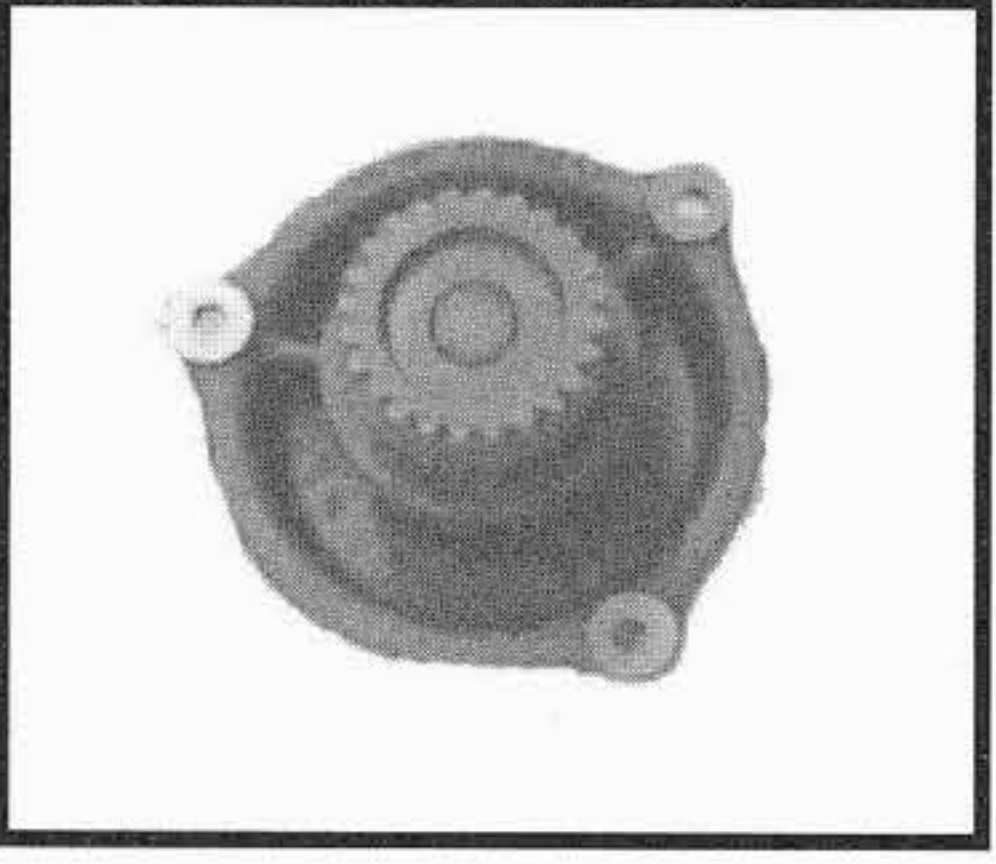
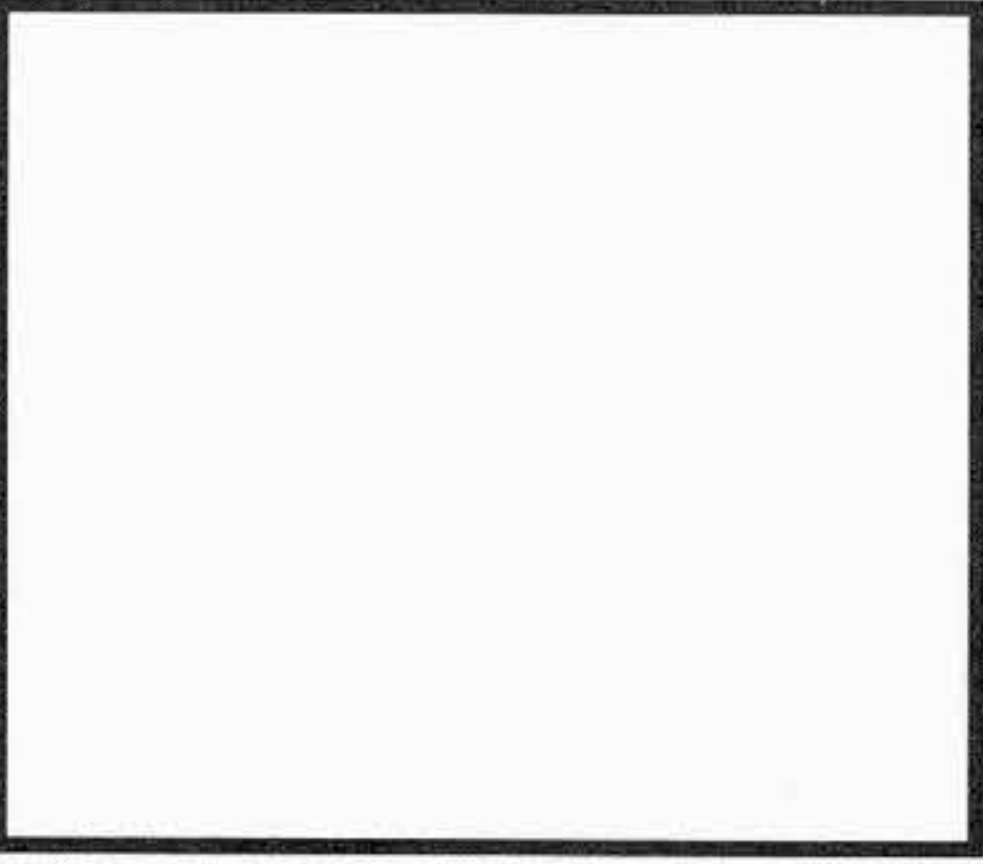
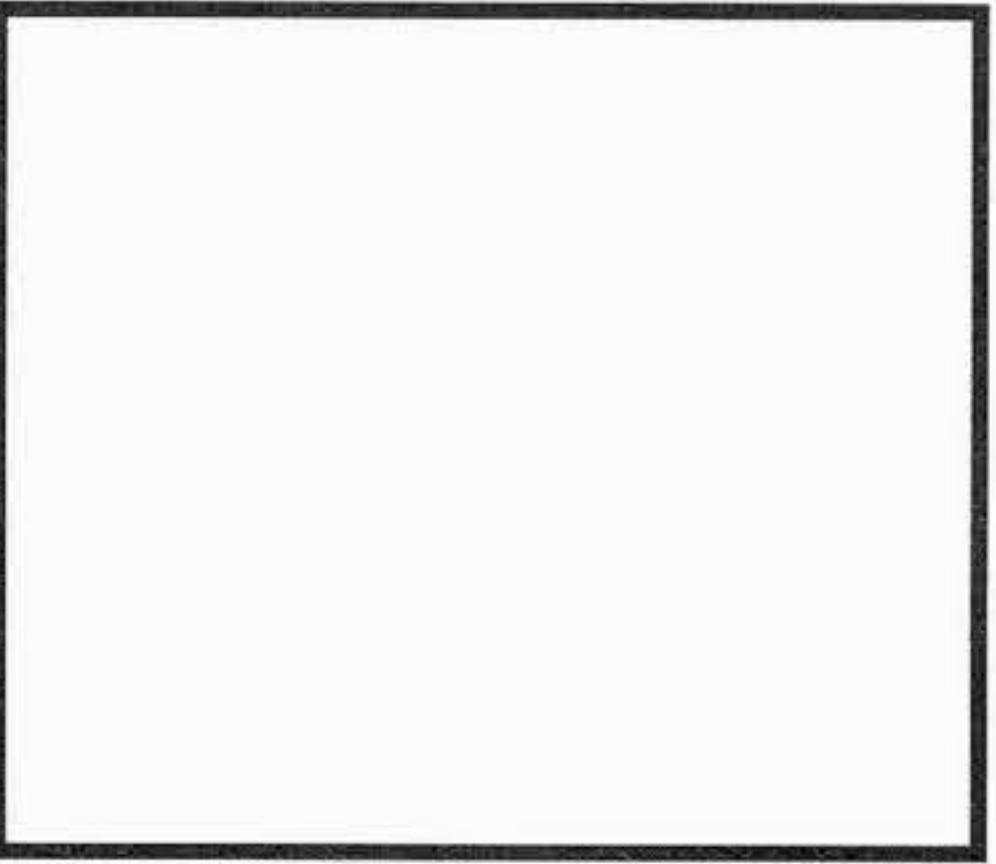
TIPO O MODELLO TYPE OU MODELE TYPE OR MODEL	MOTORE MOTEUR ENGINE	POMPA ACQUA POMPE A EAU WATER PUMP	KIT RIPARAZIONE NECESSAIRE DE REP. REPAIR KIT
FH150 W  FH150 WT	8045SI25 all.003	<p><b>196.341</b> 98497114</p> 	<p><b>192.266</b> ---</p> 
FR220	8465.21	<p><b>196.450</b> 61315464</p>  <p><b>INGRANAGGIO / GEAR</b></p>	<p><b>196.251</b> 93190288</p>  <p><b>Ø = 62,5 mm N° denti = 23</b></p>
FH400  FH400	8215.22.400  8215.42	<p><b>196.437</b> 99456317</p>  <p><b>INGRANAGGIO / GEAR</b></p>	<p><b>196.446</b> 42530032</p>  <p><b>Ø = 63 mm N° denti = 24</b></p>
			

I ricambi non sono originali ma adattabili . Ogni riferimento originale é assolutamente indicativo .  
 Spare parts are not original but perfectly suitable . Every original part number has to be considered for reference purpose only .

SUITABLE

# NEW HOLLAND BENATI - FIATHITACHI

Tel: +44(0)1925 850082 Fax: +(0)44 1925 850083

www.spwaterpumps.co.uk

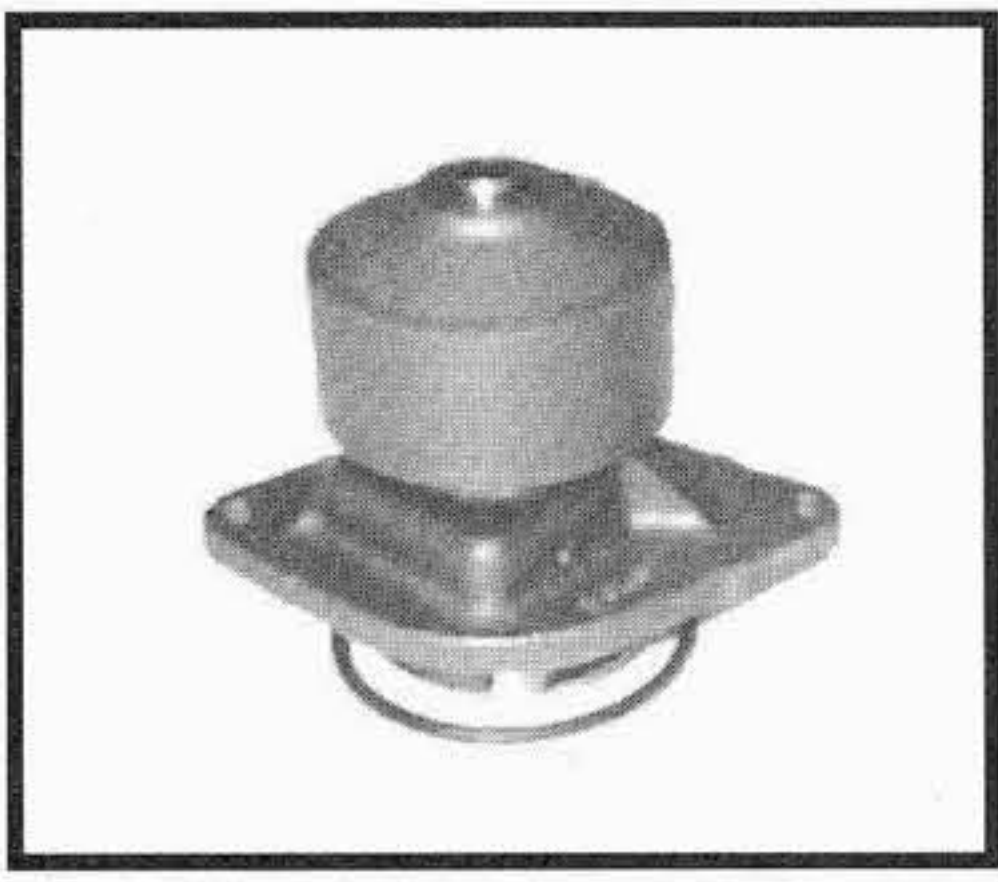
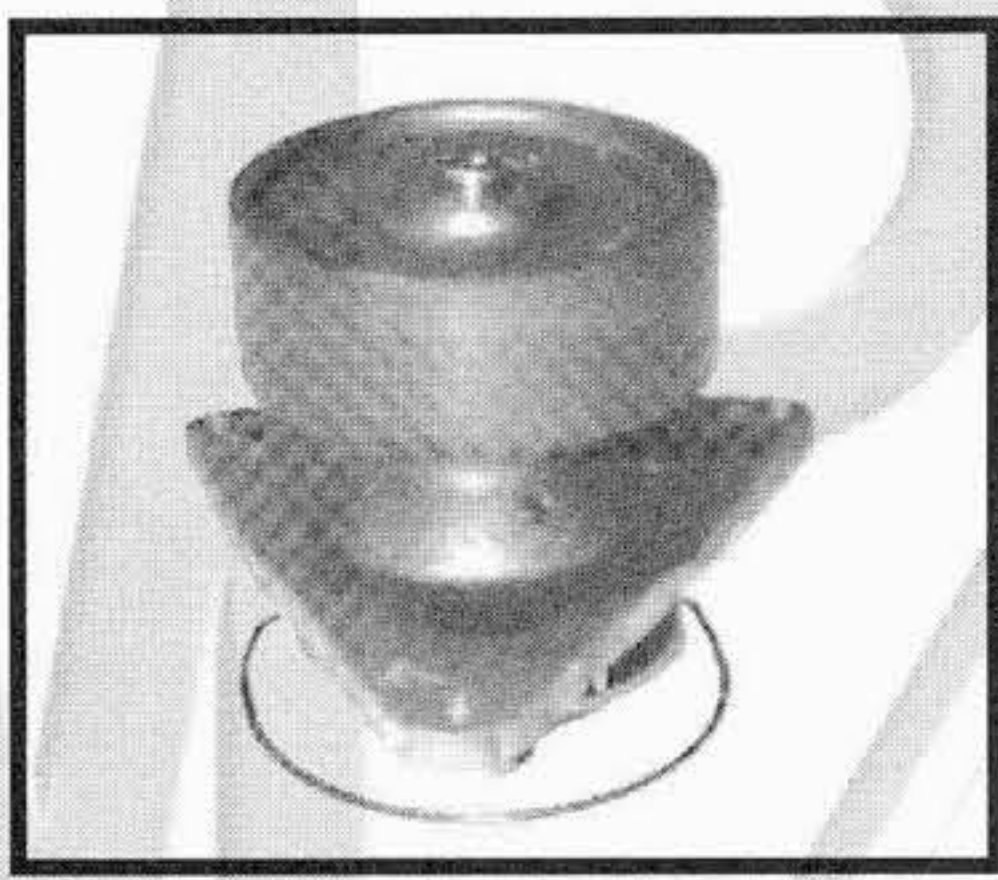
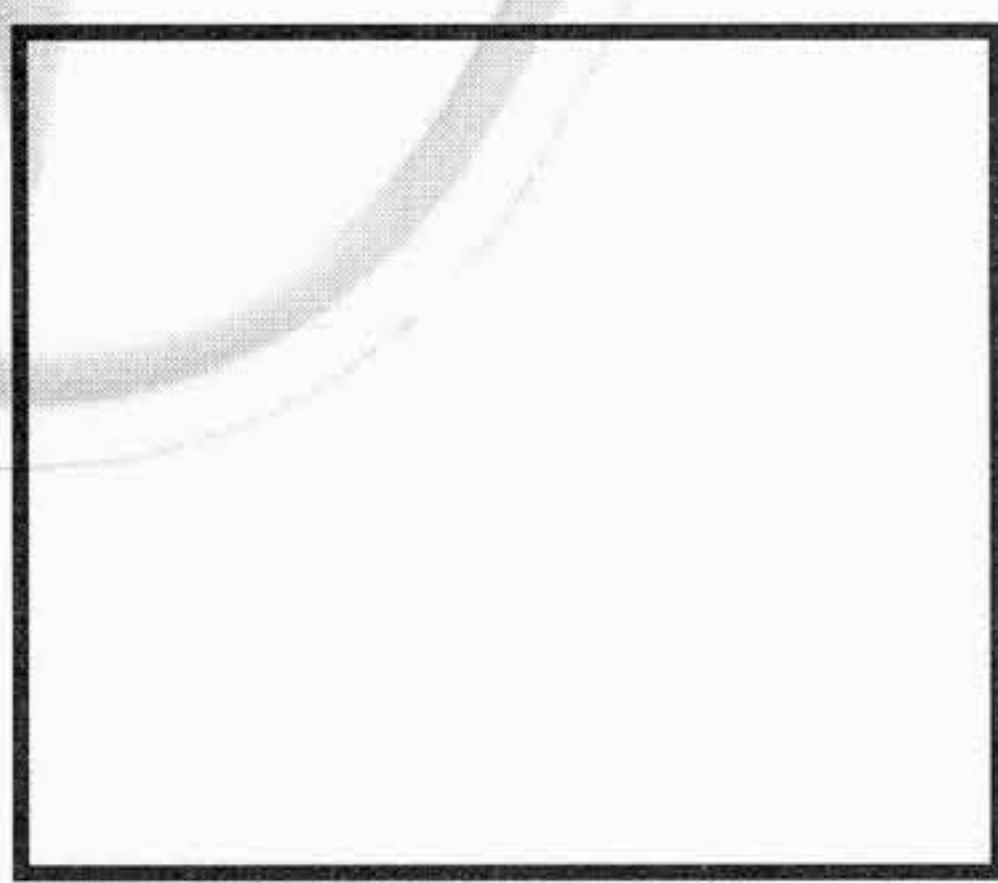
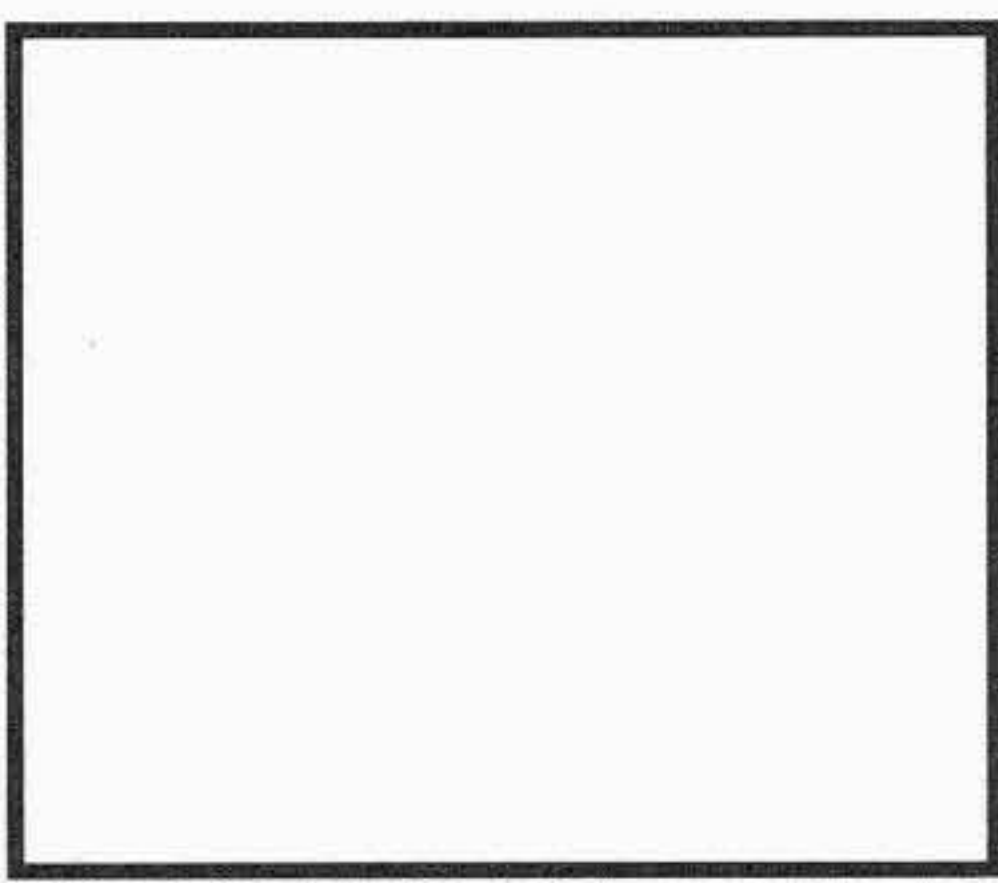
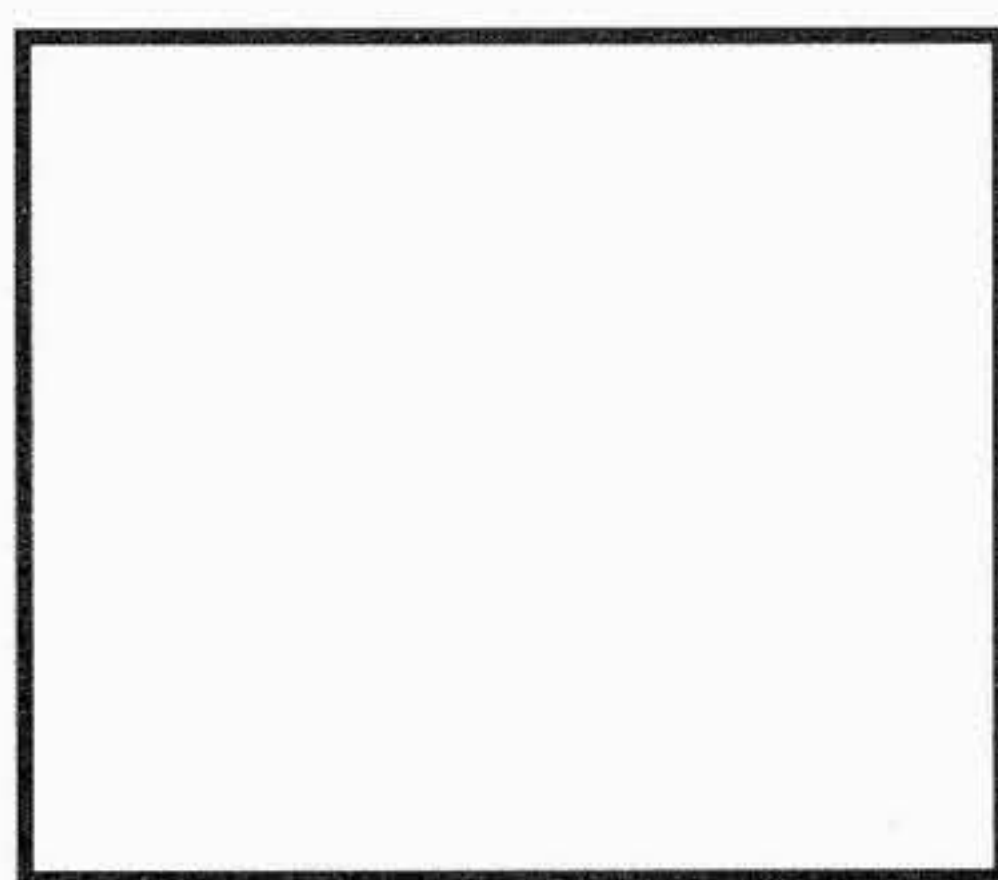
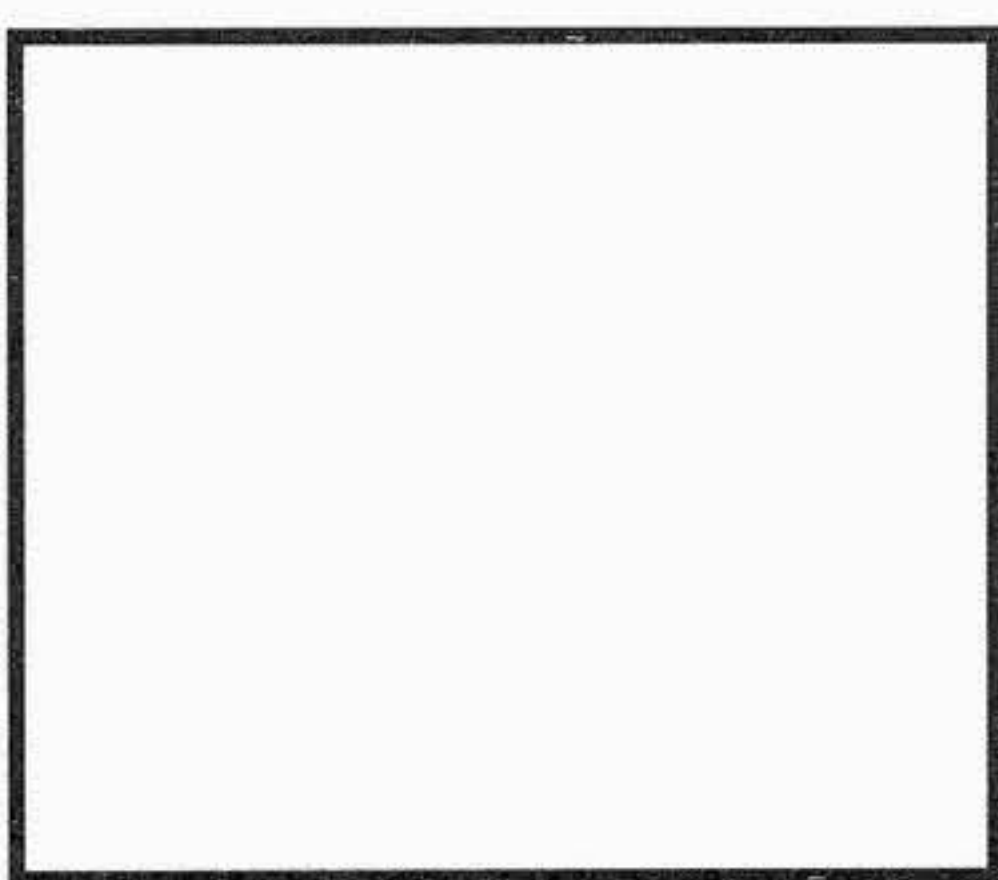

TIPO O MODELLO TYPE OU MODELE TYPE OR MODEL	MOTORE MOTEUR ENGINE	POMPA ACQUA POMPE A EAU WATER PUMP	KIT RIPARAZIONE NECESSAIRE DE REP. REPAIR KIT
<p><b>EXCAVATOR</b></p> <p>3.14</p> <p>3.22</p> <p>3.26 *</p> <p>3.130 W</p> <p>3.150 W</p>	<p>4BT</p> <p>6BT</p> <p>6BTA</p> <p>4BT</p> <p>6BT</p>	<p><b>221.020</b> 76191549</p> 	<p>NON DISPONIBILE NOT AVAILABLE</p>
<p><b>EXCAVATOR</b></p> <p>FH 270</p> <p><b>GRADER</b></p> <p>FG 70 B</p> <p>FG 75 B</p> <p>FG 85 B</p> <p>FG 105 B</p>	<p>6CT8.3</p> <p>6C8.3</p> <p>6C8.3</p> <p>6CT8.3</p> <p>6CT8.3</p>	<p><b>221.025</b> 76192604</p> 	<p>NON DISPONIBILE NOT AVAILABLE</p>
			
			

I ricambi non sono originali ma adattabili . Ogni riferimento originale é assolutamente indicativo .  
Spare parts are not original but perfectly suitable . Every original part number has to be considered for reference purpose only .

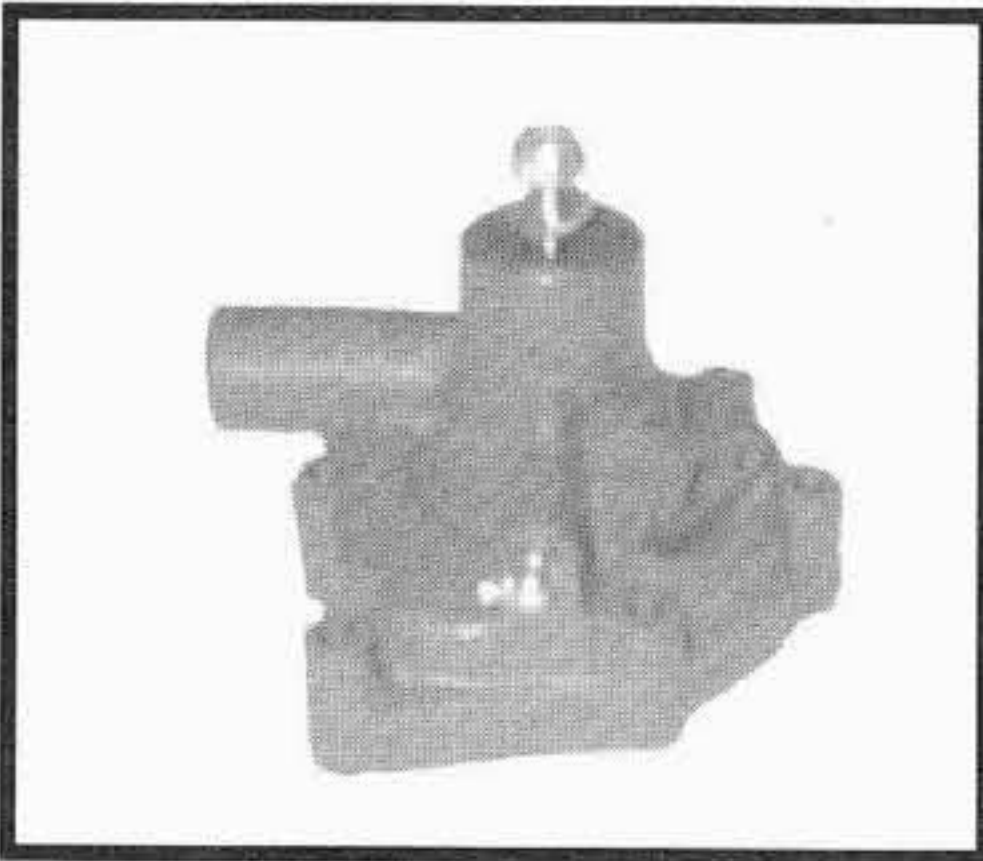
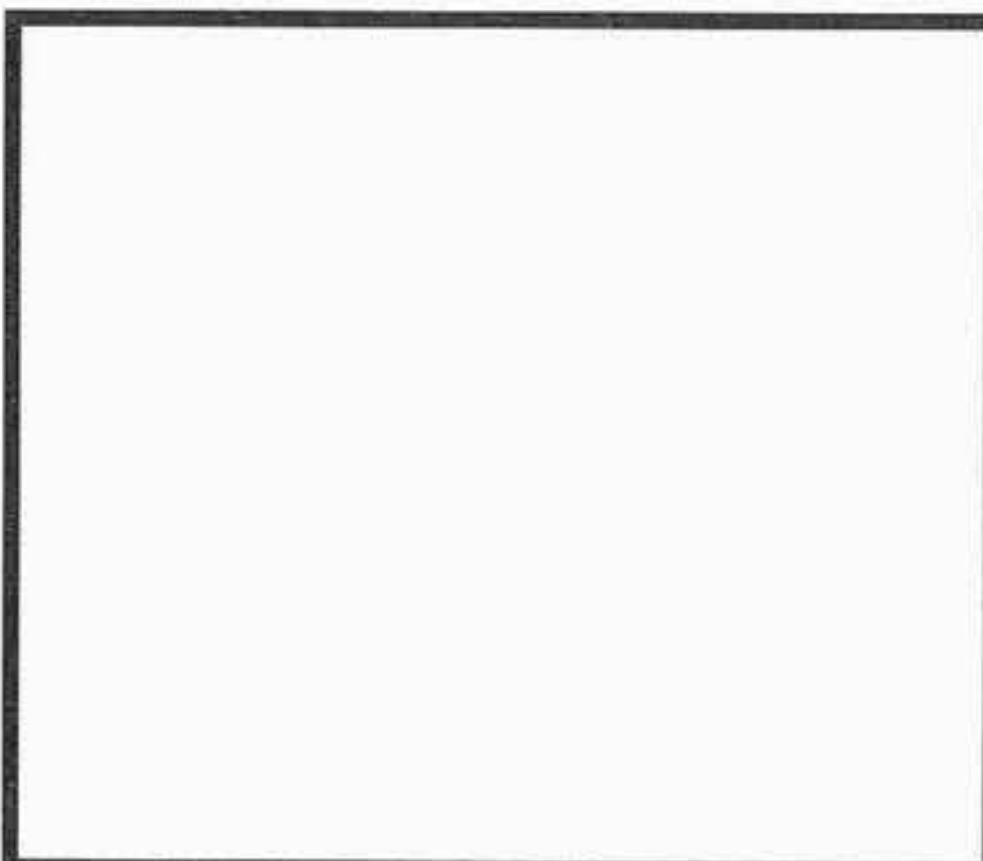
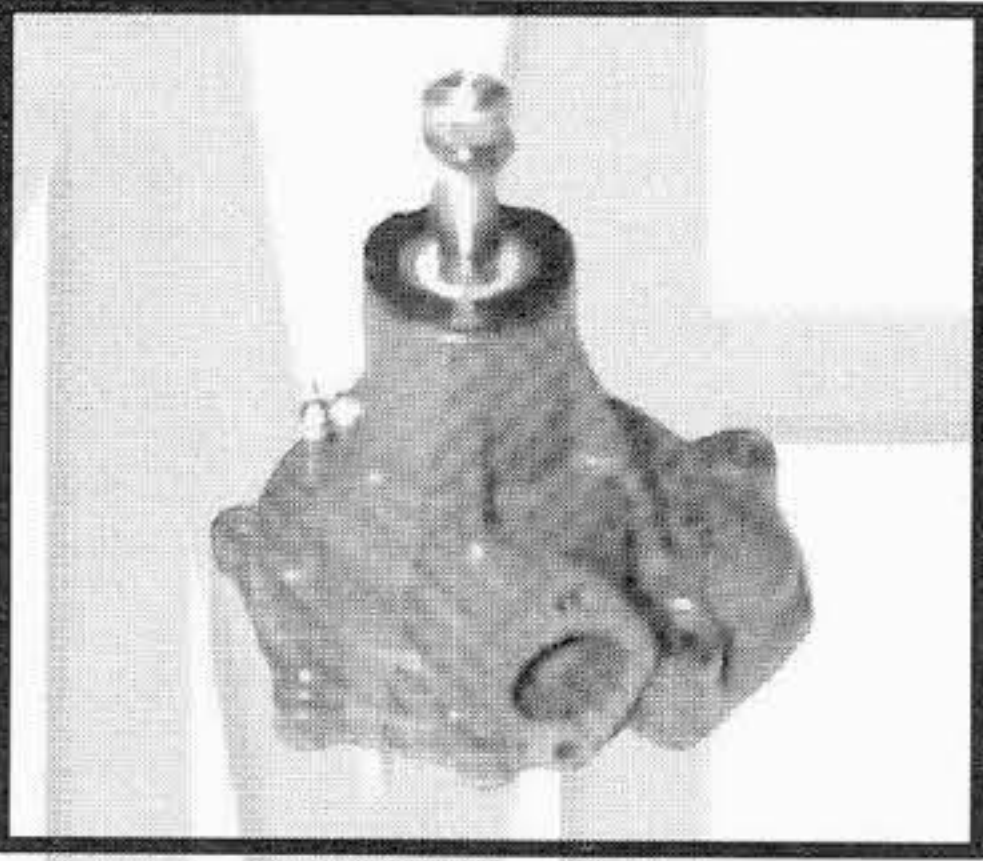
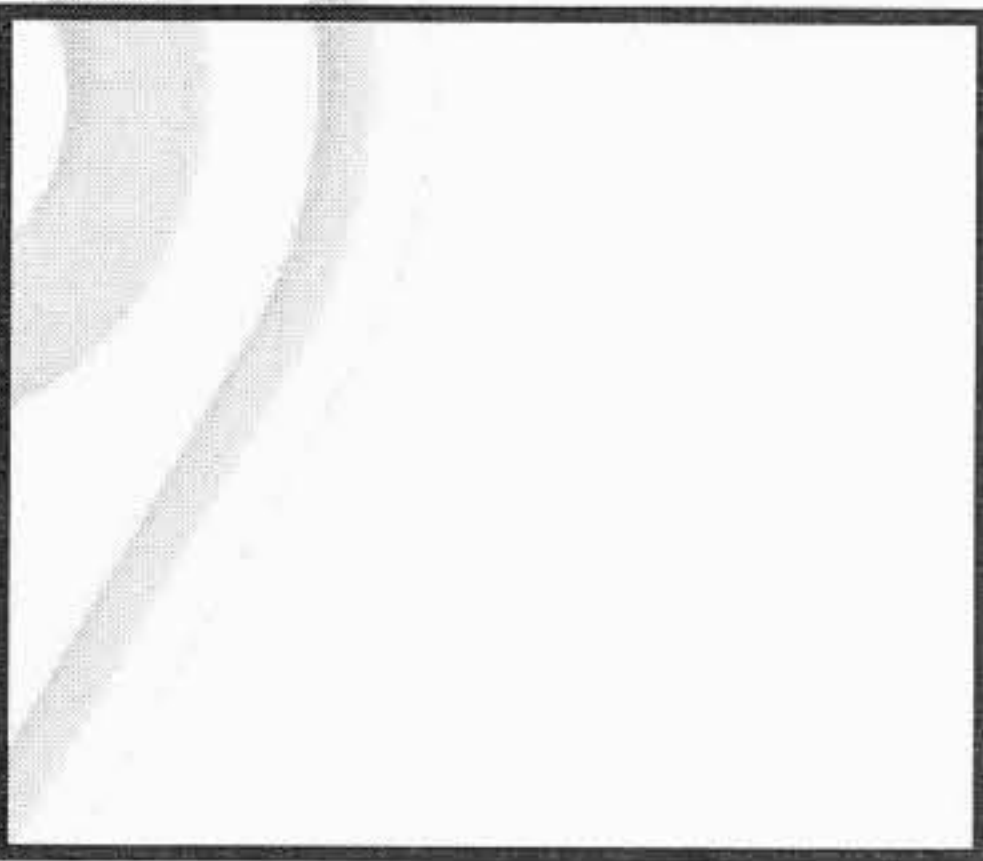
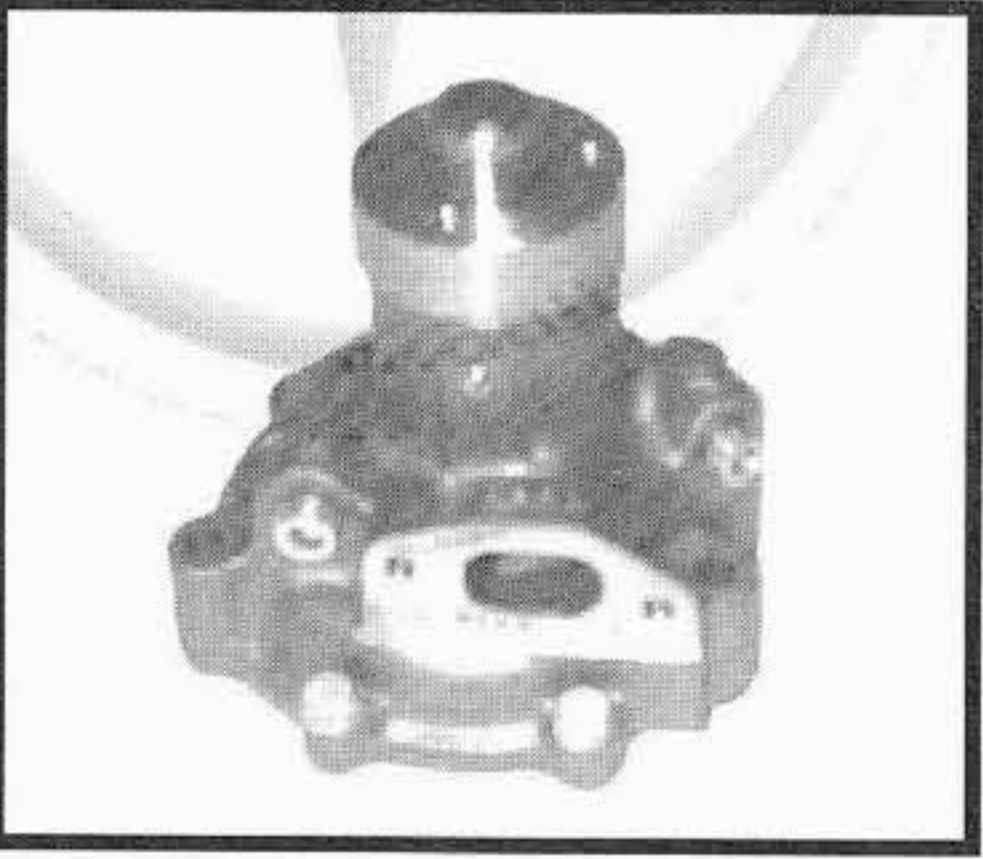
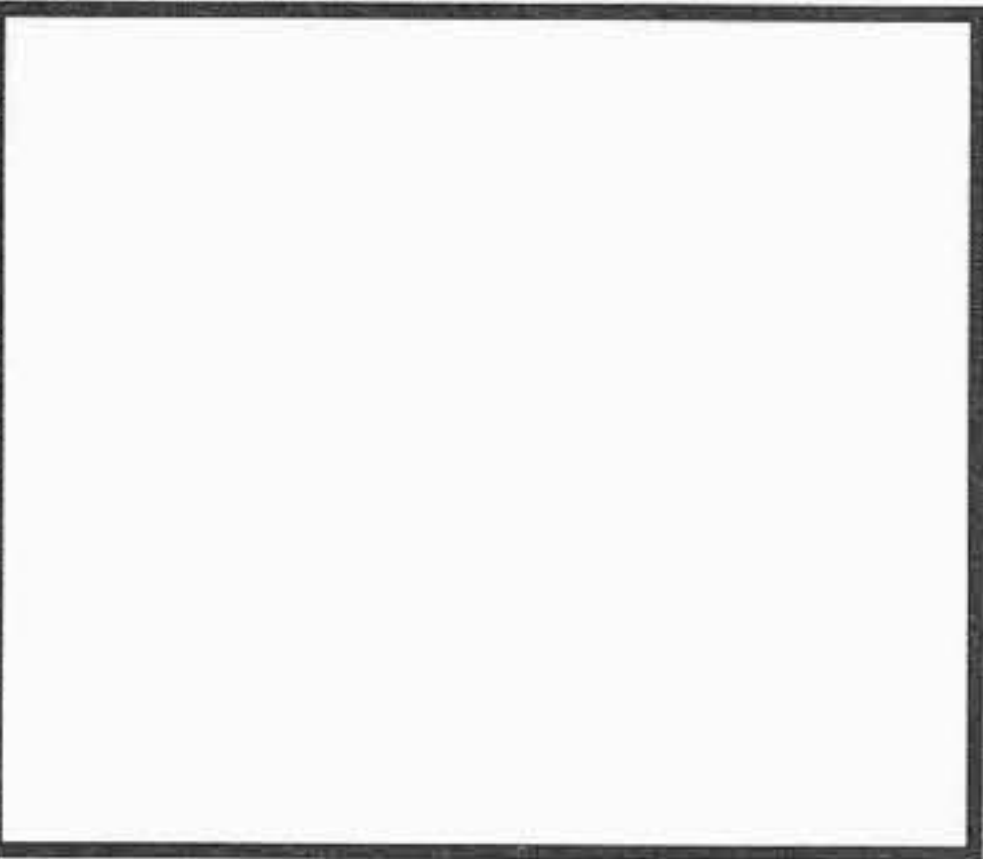
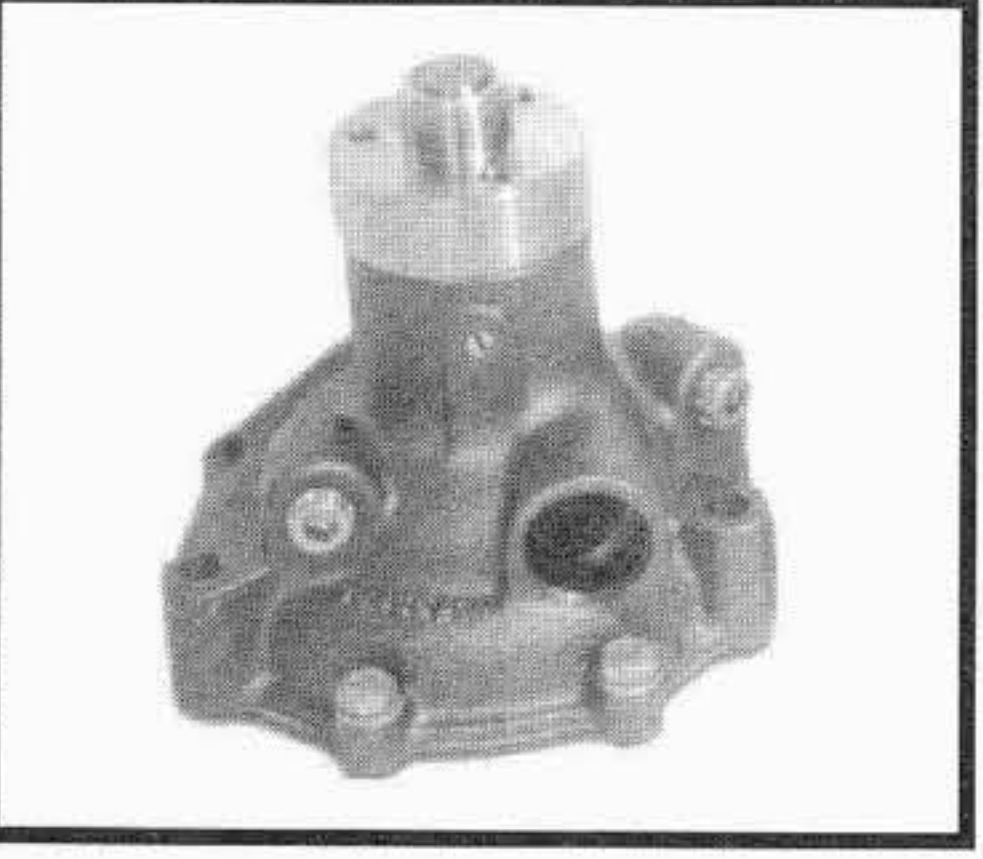
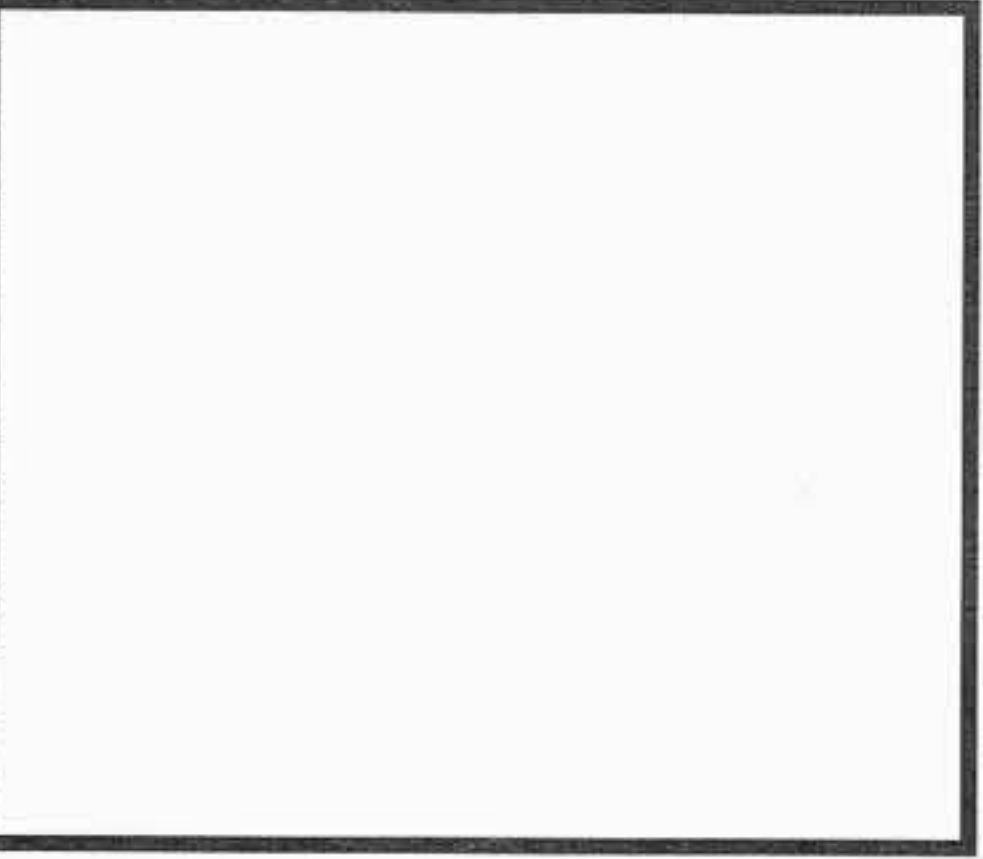
TIPO O MODELLO TYPE OU MODELE TYPE OR MODEL	MOTORE MOTEUR ENGINE	POMPA ACQUA POMPE A EAU WATER PUMP OMP REF. / O.EM. REF	KIT RIPARAZIONE NECESSAIRE DE REP. REPAIR KIT OMP REF. / O.EM. REF
25 C - 25 R	305B	<b>191.155</b> 562988 	<b>192.002</b> --- 
35 - 40 45 - 50 512 - 513 FL6	CO 2	<b>221.450</b> 577837 	<b>202.033</b> 1909625 
45.66 - 45.66DT - 50.66 - 50.66DT 55.46 - 55.46DT - 55.65F - 55.65V 55.65M - 55.66 - 55.66DT - 55.66LP 55.66 LP DT 5 55.66V - 55.66VDT 55.66F - 55.90 - 55.90DT - 60.46 60.46DT - 60.65 - 60.65M - 60.65V 60.66 - 60.66DT - 60.66LP - 60.66F 60.66LP DT60.90 - 60.90DT 65.46 - 65.46DT - 65.66 - 65.66DT 65.90 - 65.90DT - 70.65 - 70.66 70.66DT - 70.66LP - 70.66F 70.66LP DT - 70.90 - 70.90DT 80.65 - 80.66 - 80.66DT - 80.66F 80.66FDT - 80.90 - 80.90DT - 85.55 90.90 - 90.90DT - 95.55C 100.90 - 100.90DT 115.90 - 115.90DT 140.90 - 140.90DT	8035.06.206/306 8035.06.208/308 8035.06.222/322 8035.06.200/300 8045.06.220/320 8045.06.225/325 8045.06.206/306 8045.06.200/300 8045.05.206/306 8045.05.200/300 8055.05.200/205 8065.06.200/300 8065.05.000 8065.25.000	<b>206.265</b> 4813370 	<b>222.264</b> 1940105 
45.66 - 50.66 - 55.46 - 55.65 - 55.66 55.90 - 60.46 - 60.65 - 60.66 - 60.90 65.46 - 65.66 - 65.90 - 70.65 - 70.66 70.90 - 80.65 - 80.66 - 80.90 - 85.55 90.90 - 95.55C - 100.90 - 115.90 140.90DT  <b>SERIE 76 - 86 - 93 - 94</b>  tutti i modelli / all models 01 / 93 ---> 12 / 95	8035.05 - 8035.06 8045.05 - 8045.06 8055.05 - 8055.06 8065.05 - 8065.06 8065.25.000	<b>226.334</b> 98497117 	<b>222.264</b> 1940105 

I ricambi non sono originali ma adattabili . Ogni riferimento originale é assolutamente indicativo .  
 Spare parts are not original but perfectly suitable . Every original part number has to be considered for reference purpose only .







SUITABLE

# NEW HOLLAND FIAT TRATTORI

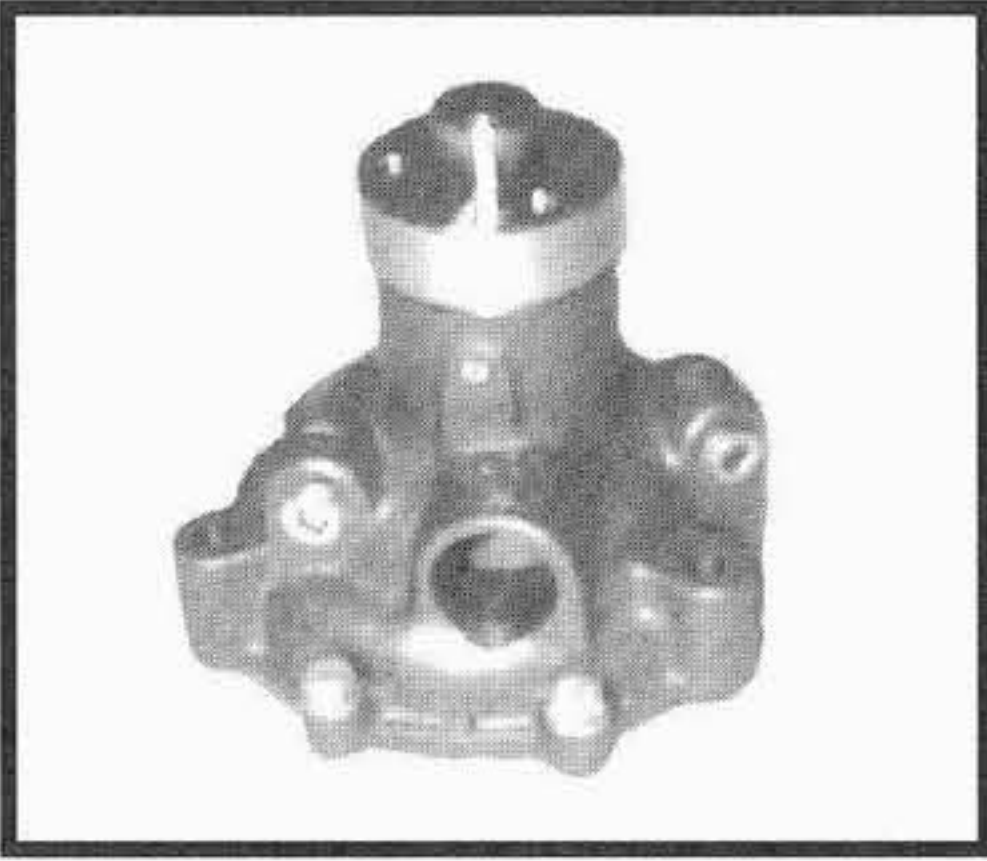
Tel: +44(0)1925 850082 Fax: +(0)44 1925 850083

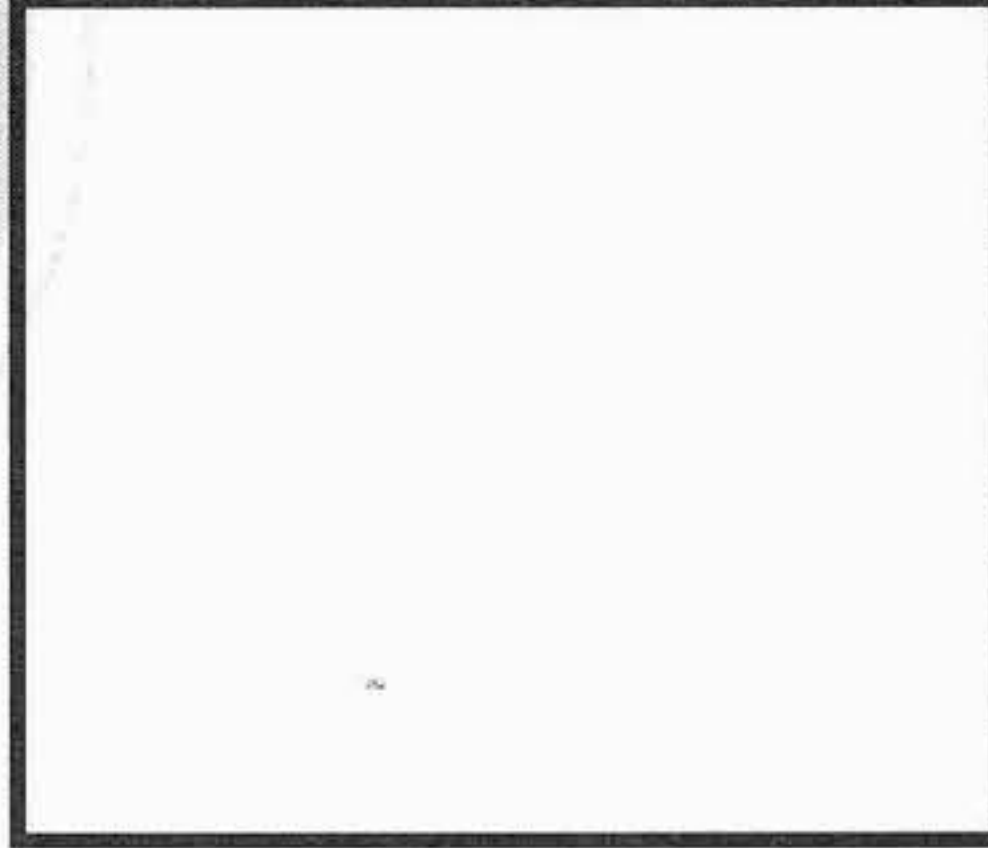
www.spwaterpumps.co.uk

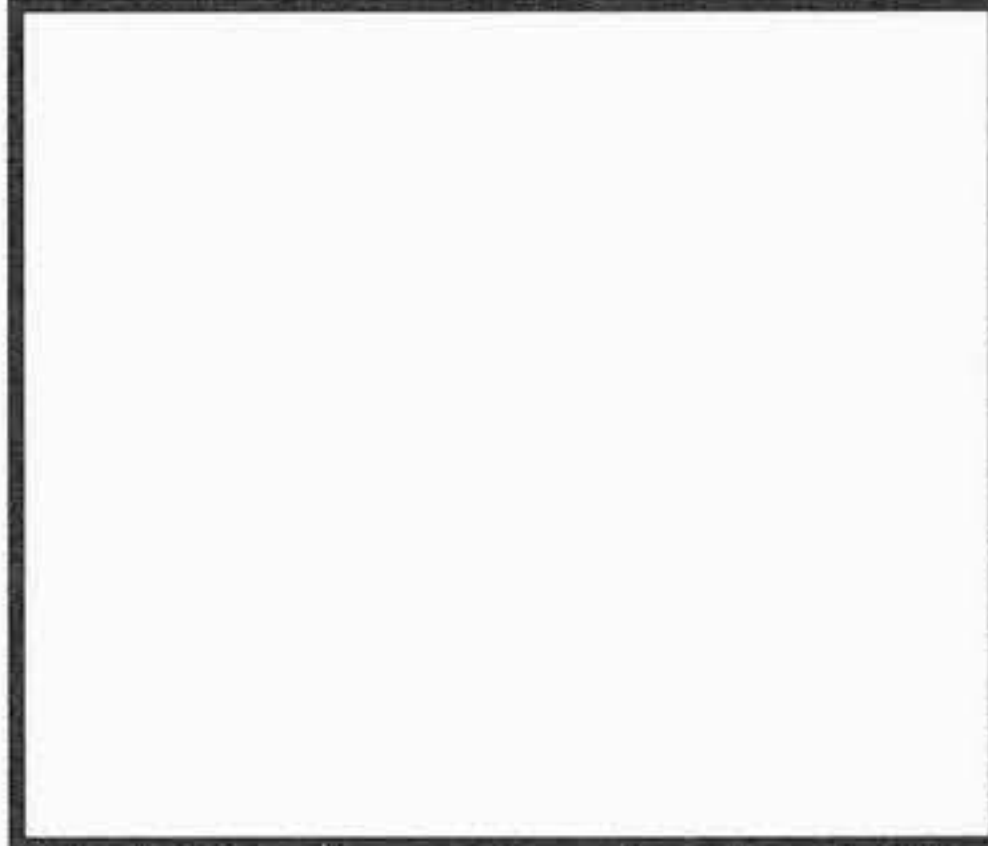

TIPO O MODELLO TYPE OU MODELE TYPE OR MODEL	MOTORE MOTEUR ENGINE	POMPA ACQUA POMPE A EAU WATER PUMP OMP REF. / O.EM. REF	KIT RIPARAZIONE NECESSAIRE DE REP. REPAIR KIT OMP REF. / O.EM. REF
45.66 - 50.66 - 55.46 - 55.65 - 55.66 55.90 - 60.46 - 60.65 - 60.66 - 60.90 65.46 - 65.66 - 65.90 - 70.65 - 70.66 70.90 - 80.65 - 80.66 - 80.90 - 85.55 90.90 - 95.55C - 100.90 - 115.90 140.90DT  SERIE 76 - 86 - 93 - 94  SERIE TNF TN65F - TN75F - TN90F  tutti i modelli / all models 01 / 96 --->	8035.05 - 8035.06 8045.05 - 8045.06 8055.05 - 8055.06 8065.05 - 8065.06 8065.25.000	<p style="text-align: center;"><b>226.441</b> 99454833</p> 	<p style="text-align: center;"><b>222.281</b> 1940144</p> 
55 - 60 - 70	604	<p style="text-align: center;"><b>201.587</b> 552387 CON PULEGGIA / WITH PULLEY</p>  <p style="text-align: center;"><b>201.585</b> --- SENZA PULEGGIA / WITHOUT PULLEY</p>	<p style="text-align: center;"><b>202.051</b> ---</p> 
70 C versione 200 / 201	604.030 ---> fino al mot. 084045	<p style="text-align: center;"><b>201.588</b> 580210 CON PULEGGIA / WITH PULLEY</p>  <p style="text-align: center;"><b>201.585</b> --- SENZA PULEGGIA / WITHOUT PULLEY</p>	<p style="text-align: center;"><b>202.051</b> ---</p> 
70 C versione 204 / 205 / 208 / 209	604.030 ---> fino al mot. 084045	<p style="text-align: center;"><b>201.590</b> 586017 CON PULEGGIA / WITH PULLEY</p>  <p style="text-align: center;"><b>201.585</b> --- SENZA PULEGGIA / WITHOUT PULLEY</p>	<p style="text-align: center;"><b>202.051</b> ---</p> 

I ricambi non sono originali ma adattabili . Ogni riferimento originale é assolutamente indicativo .  
 Spare parts are not original but perfectly suitable . Every original part number has to be considered for reference purpose only .





SUITABLE

# NEW HOLLAND FIAT TRATTORI

Tel:+44(0)1925 850082 Fax: +(0)44 1925 850083

www.spwaterpumps.co.uk

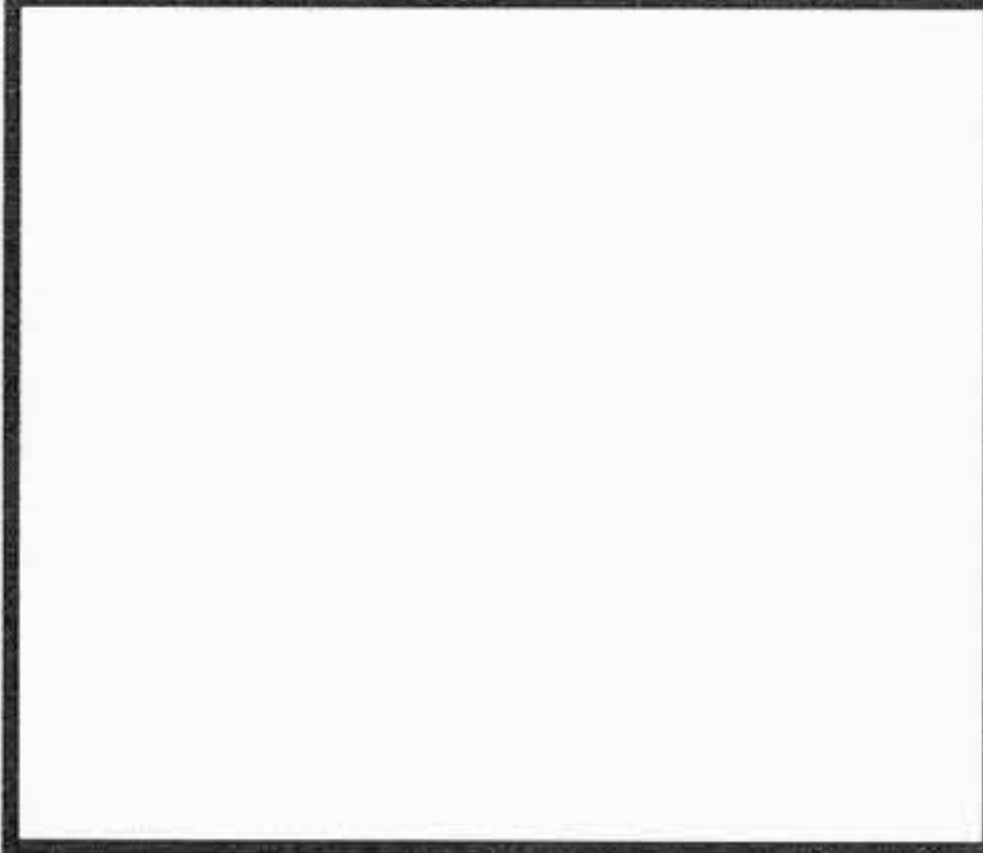
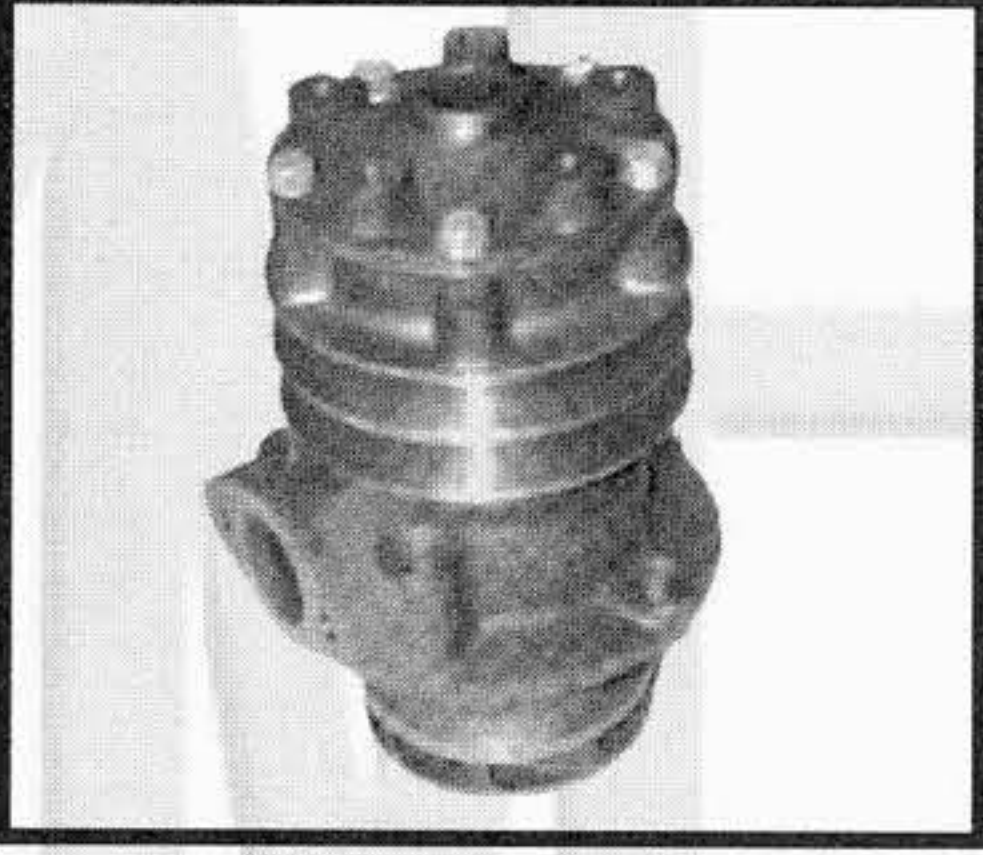

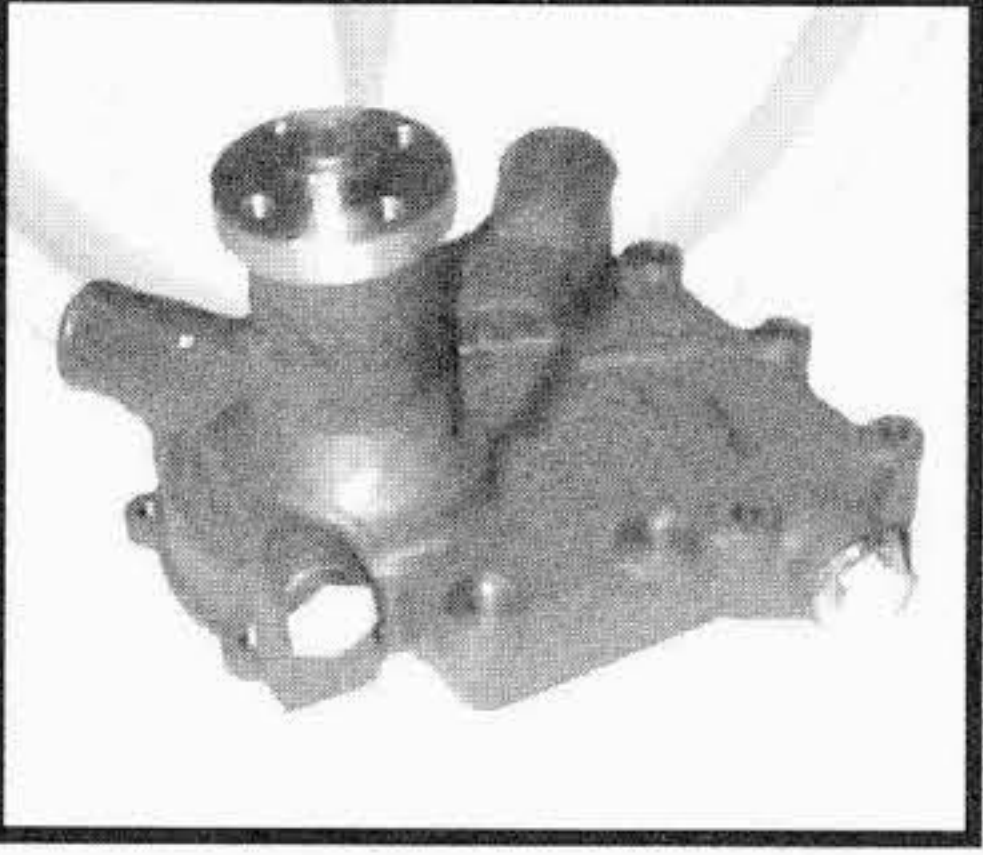
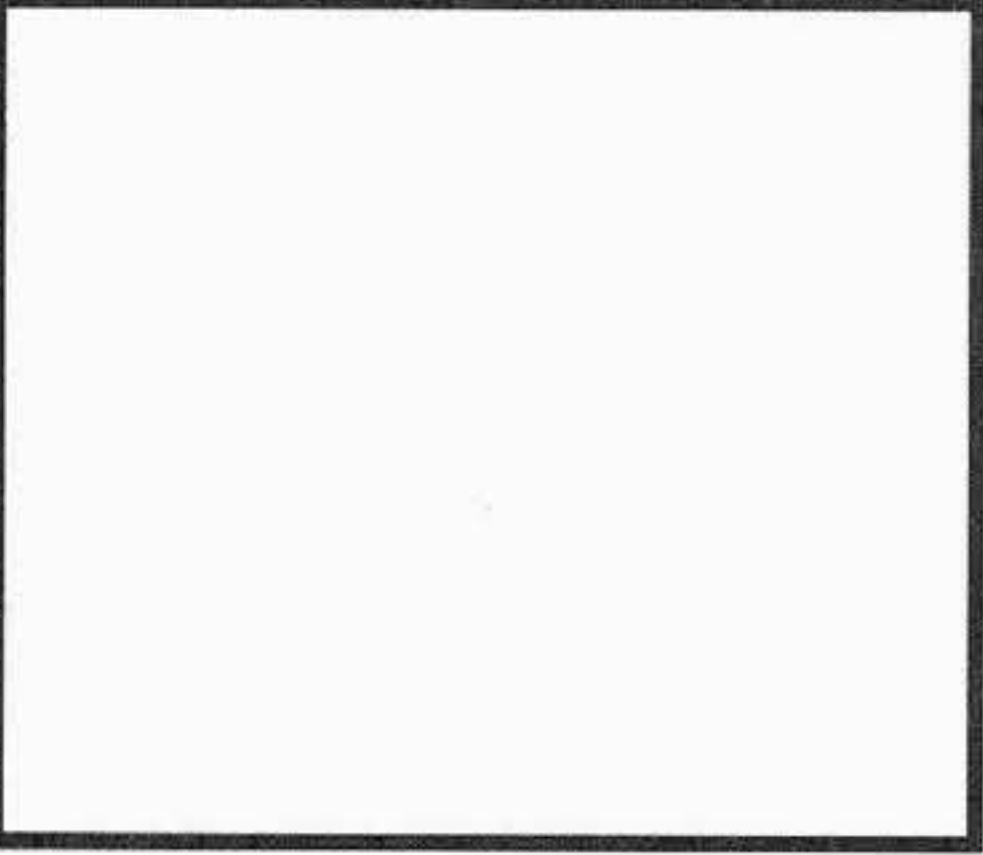
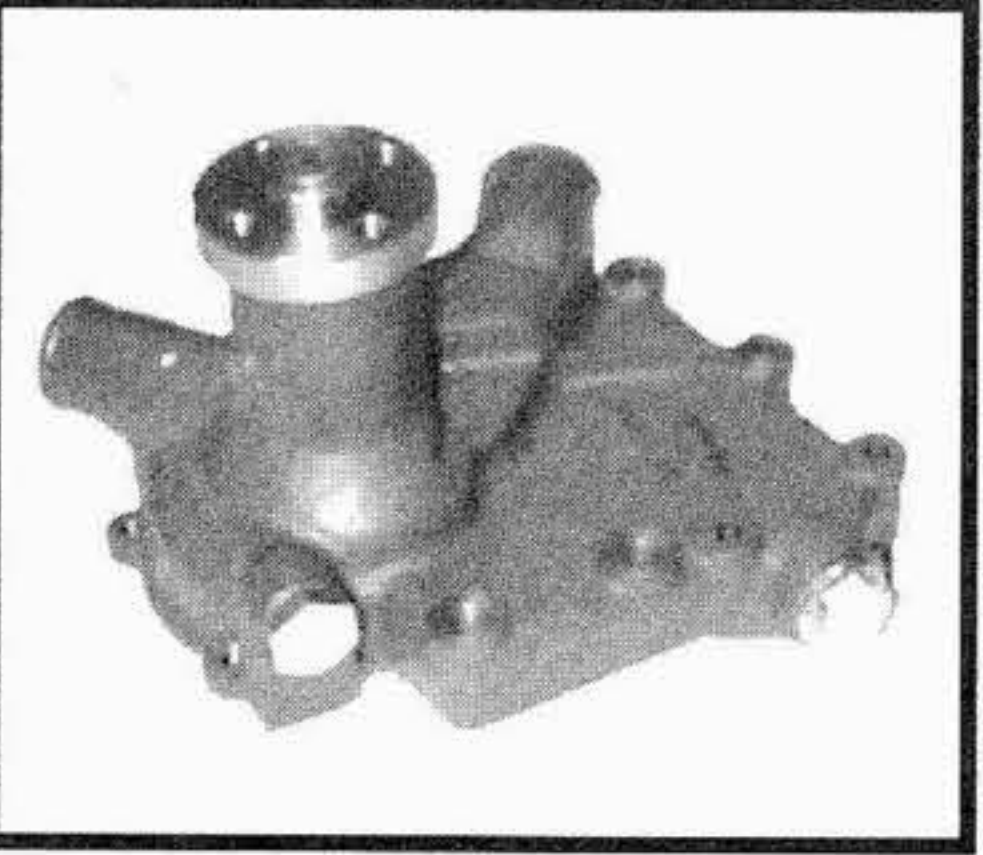
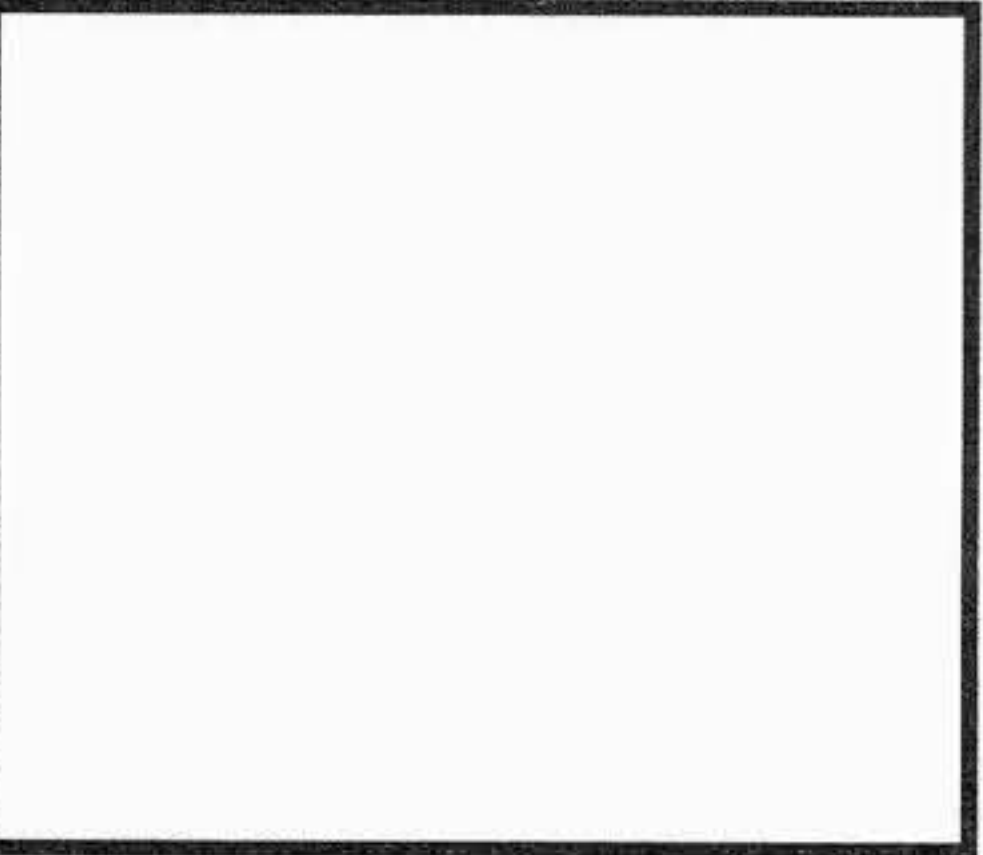





TIPO O MODELLO TYPE OU MODELE TYPE OR MODEL	MOTORE MOTEUR ENGINE	POMPA ACQUA POMPE A EAU WATER PUMP OMP REF. / O.EM. REF	KIT RIPARAZIONE NECESSAIRE DE REP. REPAIR KIT OMP REF. / O.EM. REF
70 C versione 200 / 201	604.030 dal mot. 084046 --->	<p><b>201.596</b> 4629940 CON PULEGGIA / WITH PULLEY</p>  <p><b>201.595</b> --- SENZA PULEGGIA / WITHOUT PULLEY</p>	<p><b>202.056</b> 1909615</p> 
70 C versione 204 / 205 / 208 / 209	604.030 dal mot. 084046 --->	<p><b>201.597</b> 4959164 CON PULEGGIA / WITH PULLEY</p>  <p><b>201.595</b> --- SENZA PULEGGIA / WITHOUT PULLEY</p>	<p><b>202.056</b> 1909615</p> 
80 C 100 C 120 C	CP3 / 100 CP3 / 100 var. 20 CP3 / 100 var.21/22	<p><b>201.955</b> 4757341</p> 	<p><b>222.267</b> 76032963</p> 
90 C	CO3.130T var.2.300	<p><b>201.935</b> 4757340</p> 	<p><b>202.016</b> 1909829</p> 

I ricambi non sono originali ma adattabili . Ogni riferimento originale é assolutamente indicativo .  
Spare parts are not original but perfectly suitable . Every original part number has to be considered for reference purpose only .

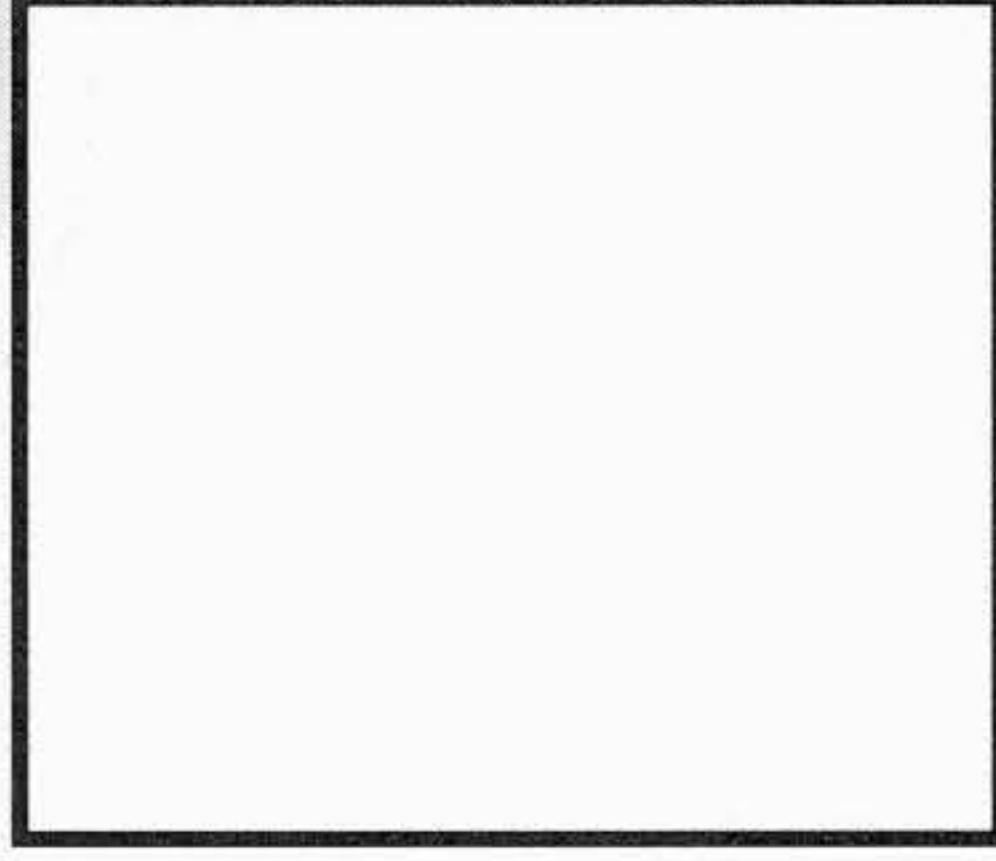
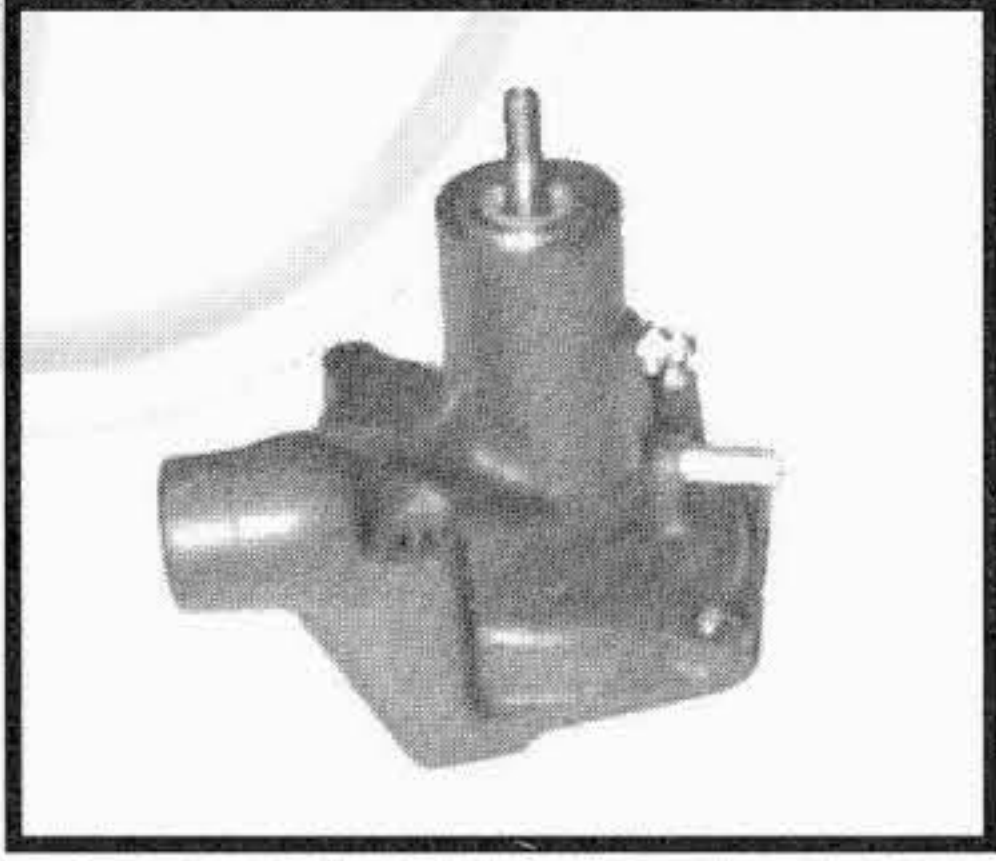
SUITABLE

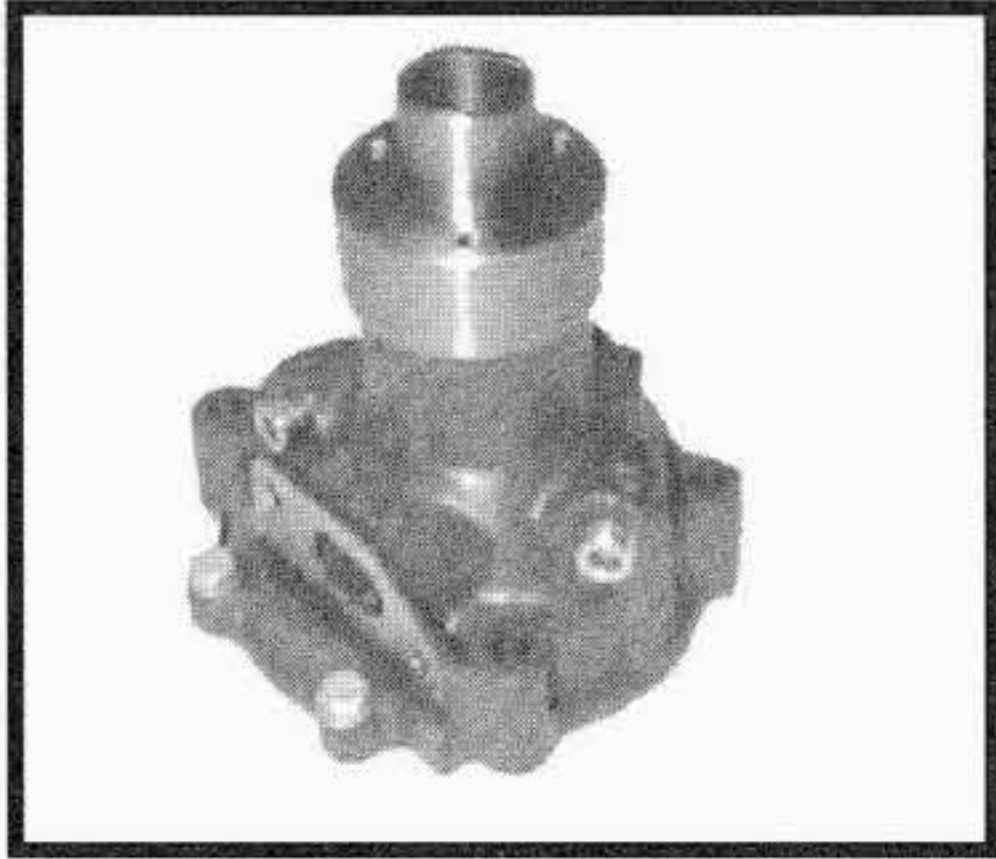
**NEW HOLLAND****FIAT TRATTORI****Tel:+44(0)1925 850082 Fax: +(0)44 1925 850083****www.spwaterpumps.co.uk**

TIPO O MODELLO TYPE OU MODELE TYPE OR MODEL	MOTORE MOTEUR ENGINE	POMPA ACQUA POMPE A EAU WATER PUMP OMP REF. / O.EM. REF	KIT RIPARAZIONE NECESSAIRE DE REP. REPAIR KIT OMP REF. / O.EM. REF
160.90 - 160.90 DT 180.90 - 180.90 DT 1355 C 1580 - 1580 DT 1580 DT turbo 1880 - 1880 DT	8365.25.503 8365.25.502 8365.05.590 8365.05.500 8365.25.501 8365.25.500	<b>206.100</b> 4796534 	<b>202.268</b> 1940119 
250 / N / F / DT - 300 / N / F / DT 350 / N / S / DT - 355 / M / F / C 400 / N / DT / DTN - 420 / DT - 440 / DT / V 446 / DT - 450 / F / V / DT / S R450 / N / V / DT - 455 / M / V / CI / C / CM / M / CF 455 SUPER - 460 / DT - 465 C / CV 465 CF - 466 DT - 470 / DT / E / F / S 470 S DT - 474 / DT - 480 / DT / V / S 480.8 / DT / V - 500 / DT / S / DTS 505 C / CM / V / S - 540 S / VS / DTS 540 / F / FS / DT - 550 / DT / 555 / M 565 C / CL - 566 / DT - 570 / DT / V / DTF 600 / DT - 605 C / CM / CS / CMS 640 / DT - 665 C / CM / 666 / DT 670 / DT / F / FDT - 765 C - 766 / DT 880.5 / DT5 - 980 / DT - 1000 / DT 1000 / S / SDT - 1180 / DT - 1280 / DT 1380 / DT	8025.01 8035.01 8035.02.309 8035.01.305 8035.02.276/376 8035.02.313 8045.01.211 8045.02.271/278.371.378 8065.02 8065.04 8065.24	<b>196.319</b> 93191101 	<b>222.260</b> 76029352 
400 - 411 - 415 - FL4	615.000	<b>201.390</b> 566997 	<b>202.025</b> 1909619 
580 - 580 DT 680 - 680 DT 780 - 780 DT 855C	8035.04.370/377 8045.02. 270/277/370/377 8045.02. 270/277/370/377 8045.04.275/375	<b>196.326</b> 1930925 	<b>222.261</b> 1940104 

I ricambi non sono originali ma adattabili . Ogni riferimento originale é assolutamente indicativo .

Spare parts are not original but perfectly suitable . Every original part number has to be considered for reference purpose only .

SUITABLE

**NEW HOLLAND**

**FIAT TRATTORI**

**Tel:+44(0)1925 850082 Fax: +(0)44 1925 850083**

**www.spwaterpumps.co.uk**

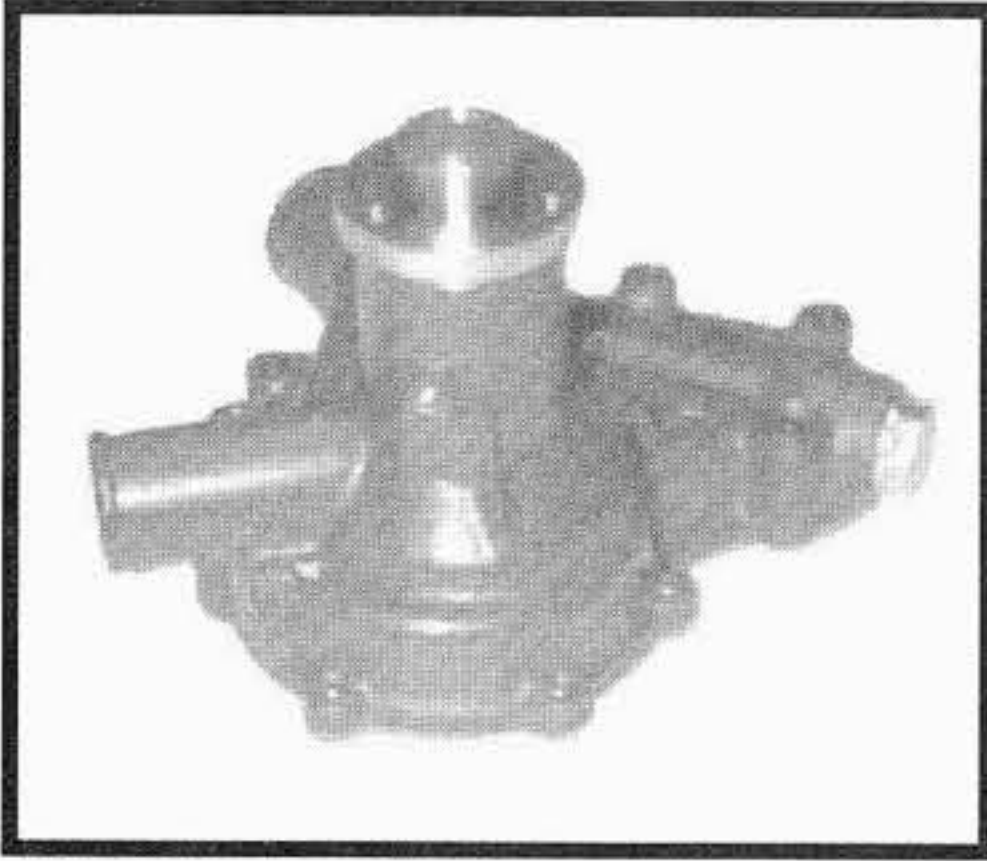
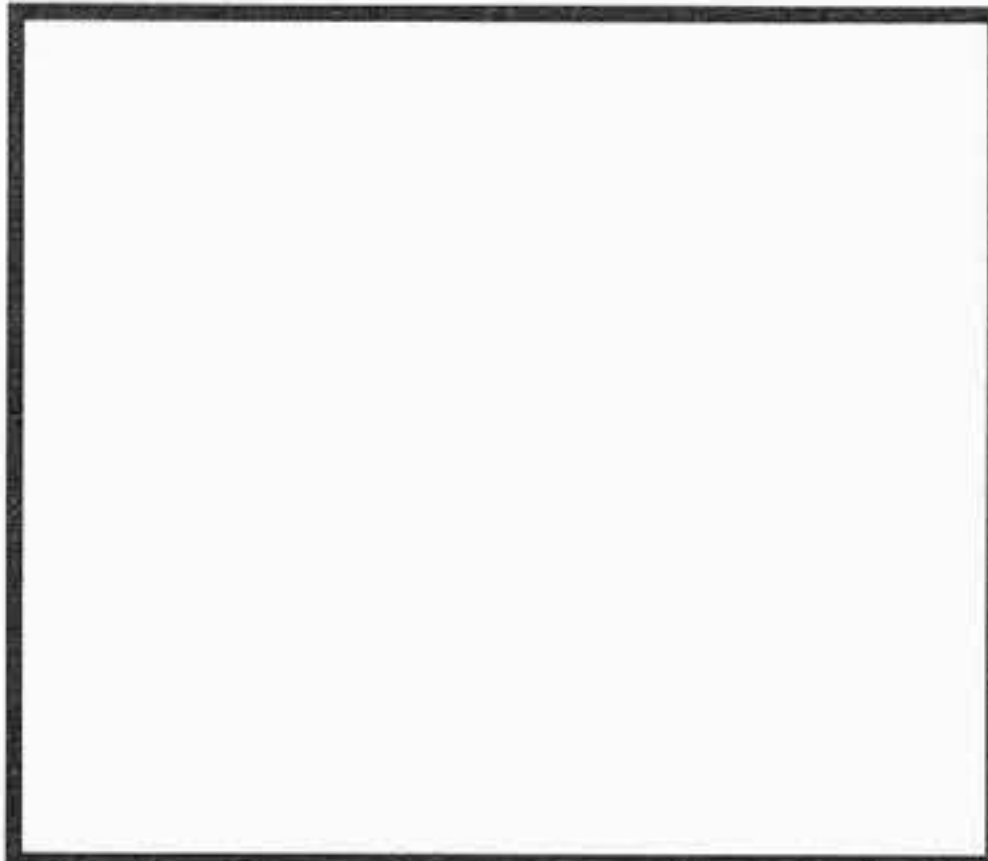
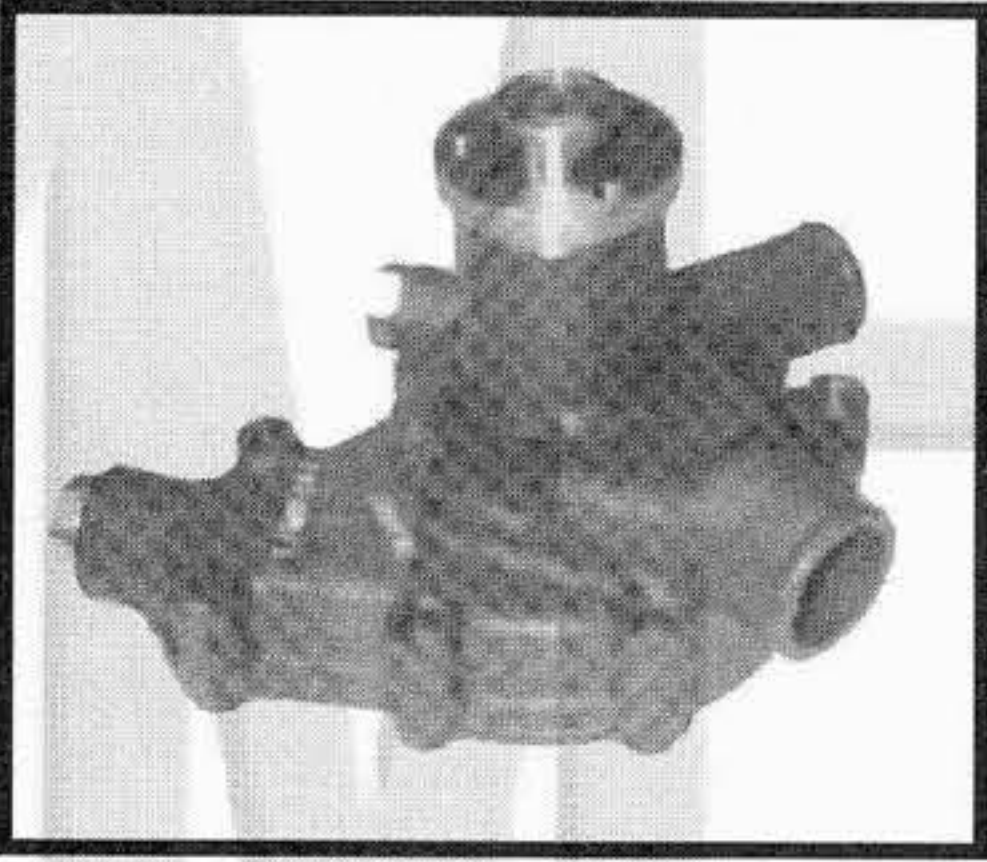
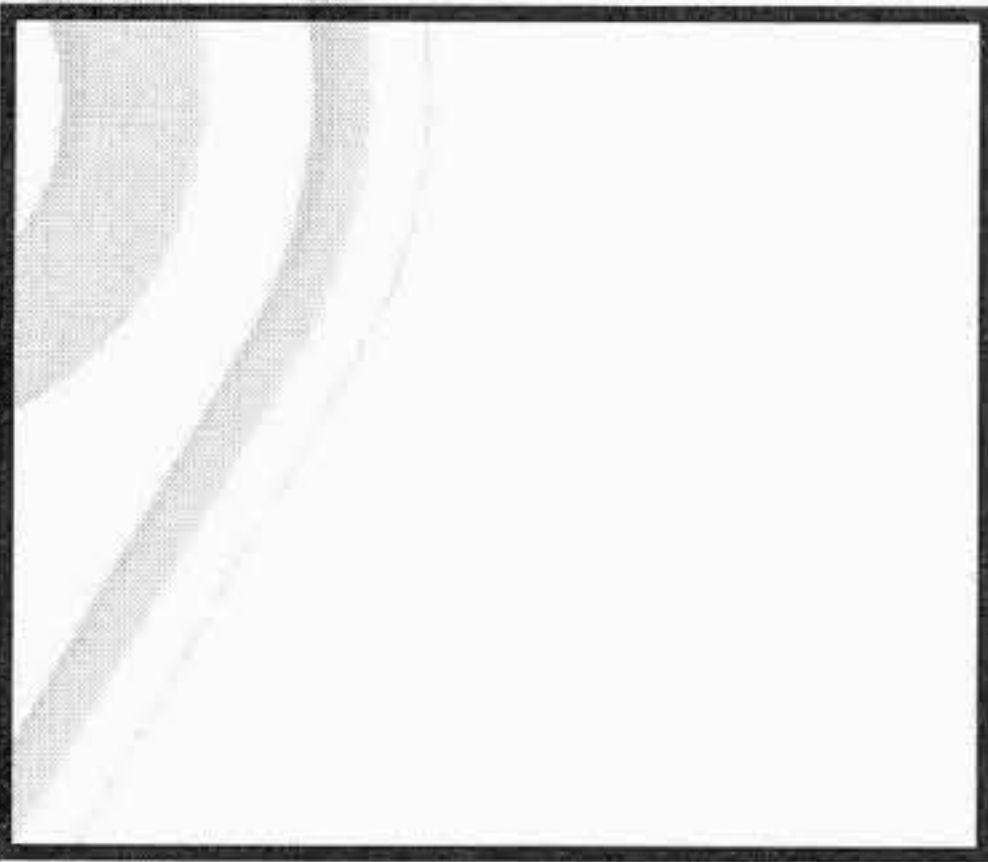
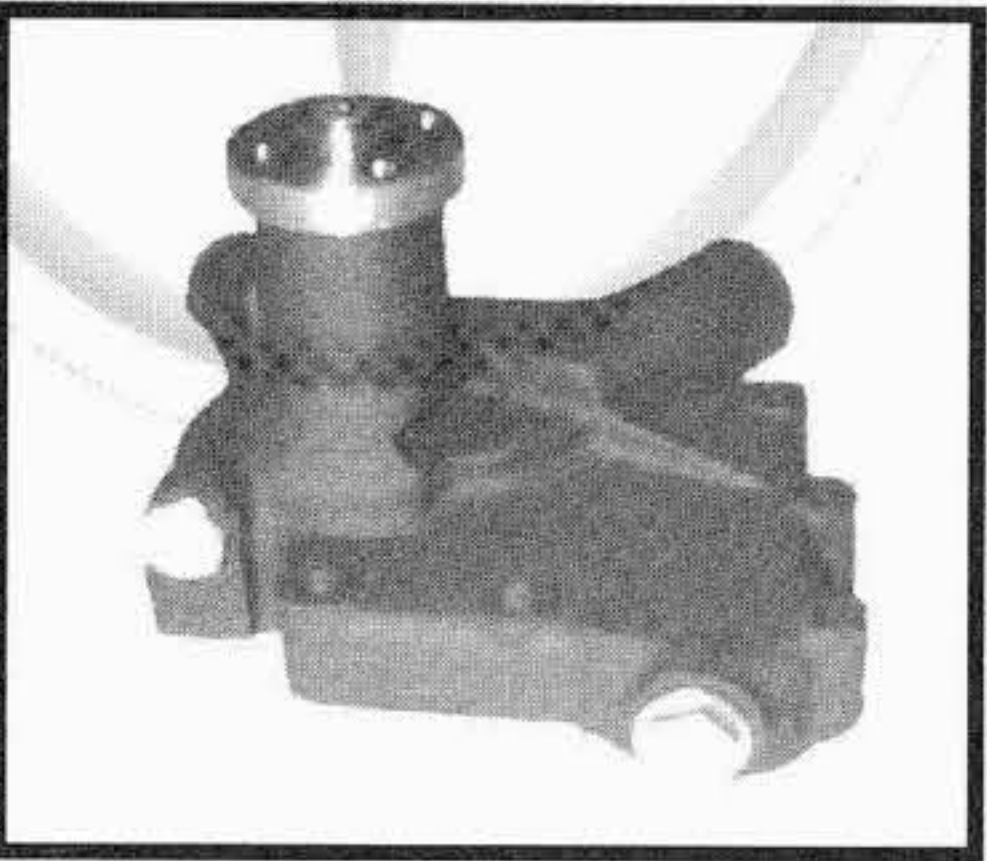
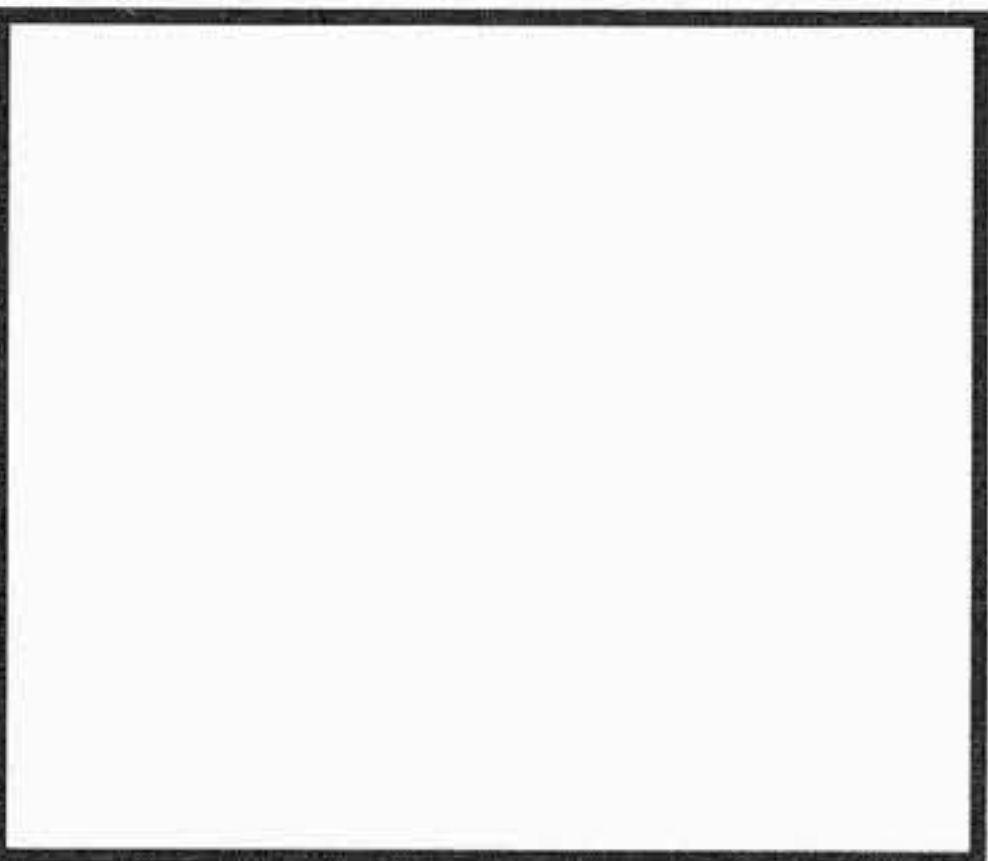
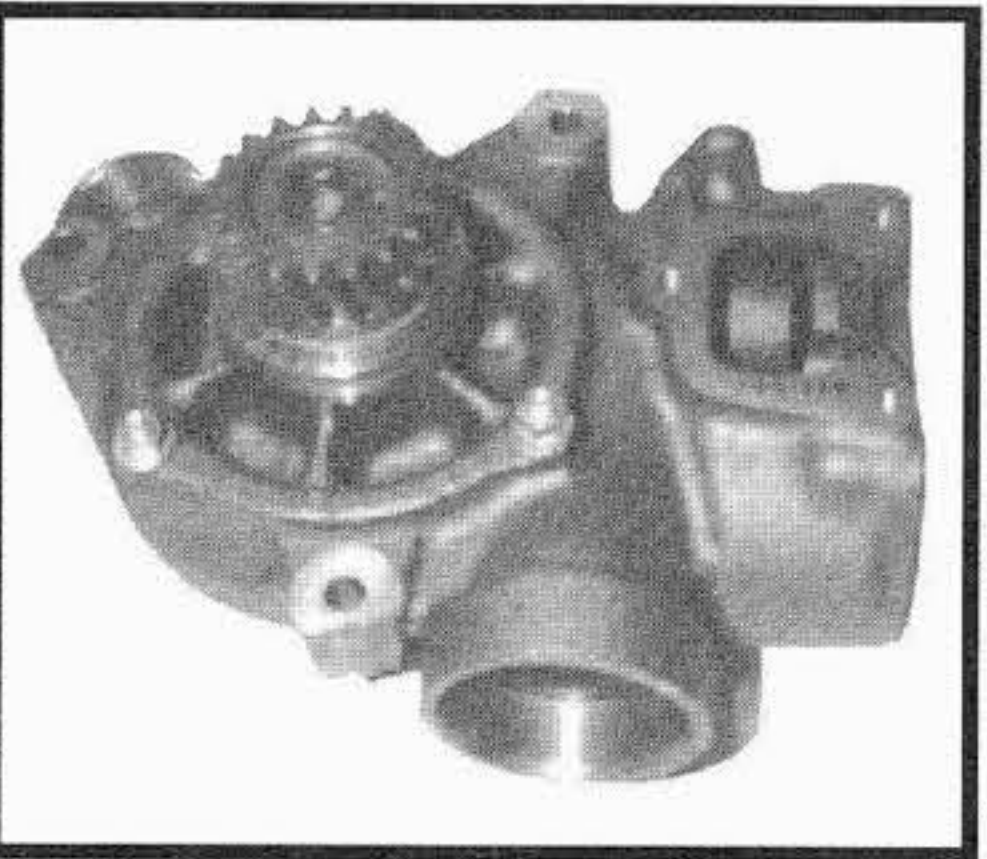
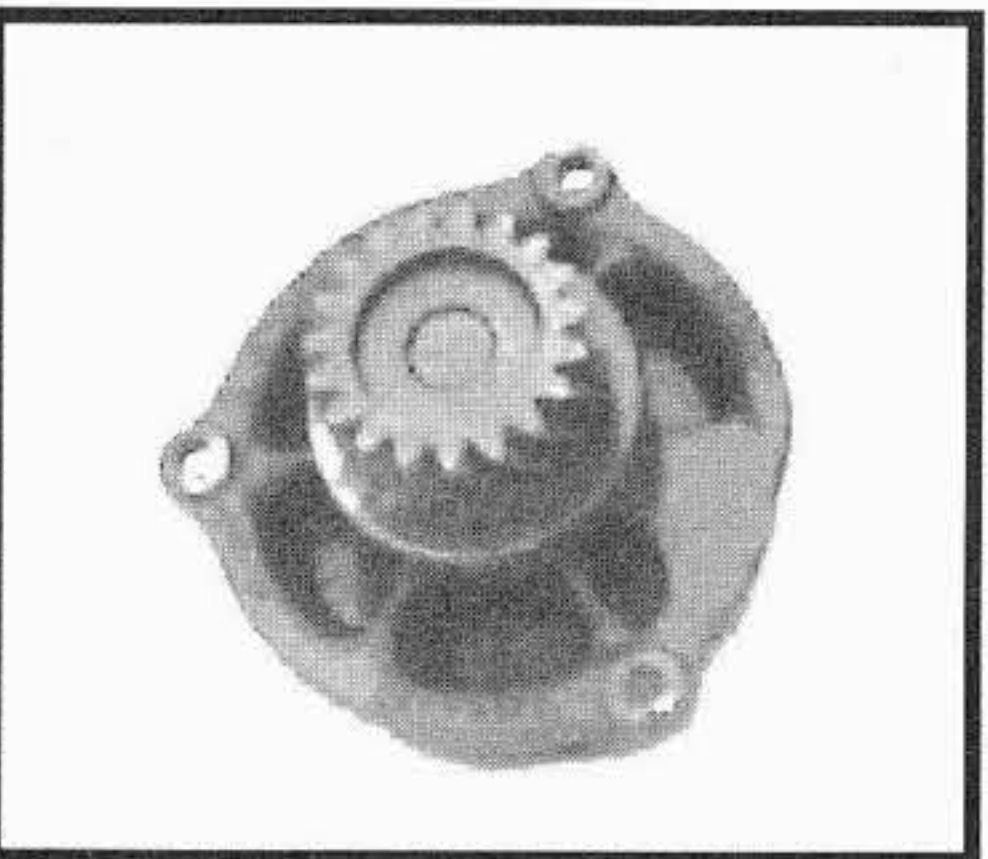

TIPO O MODELLO TYPE OU MODELE TYPE OR MODEL	MOTORE MOTEUR ENGINE	POMPA ACQUA POMPE A EAU WATER PUMP OMP REF. / O.EM. REF	KIT RIPARAZIONE NECESSAIRE DE REP. REPAIR KIT OMP REF. / O.EM. REF
650 - 650 DT - 655 - 655C  750 - 750 DT  805 C  850 - 850 S - 850 DT S	CO 3  CO 3  CO 3 / 75 var. 50  CO 3 / 80 var. 6/7	<p><b>221.485</b> 8829787</p> 	<p><b>222.262</b> 76031329</p> 
880 - 880 DT	CO 3 / 75 var.2 / 4 / 10	<p><b>201.490</b> 8829790</p> 	<p><b>202.041</b> 1909623</p> 
1300 - 1300 DT  1300 S - 1300 S DT	CP 3 / 100 var.16  CP 3 / 100 var.16	<p><b>201.604</b> 8829805</p> 	<p><b>222.267</b> 76032963</p> 
FX 300 - FX 375 - FX 450	8215.42	<p><b>196.485</b> 98447661</p>  <p><b>INGRANAGGIO / GEAR</b></p>	<p><b>216.419</b> 99445447</p>  <p><b>Ø = 65 mm N° denti = 19</b></p>

I ricambi non sono originali ma adattabili . Ogni riferimento originale é assolutamente indicativo .  
Spare parts are not original but perfectly suitable . Every original part number has to be considered for reference purpose only .

SUITABLE





**NEW HOLLAND**

**LAVERDA**

**Tel:+44(0)1925 850082 Fax: +(0)44 1925 850083**

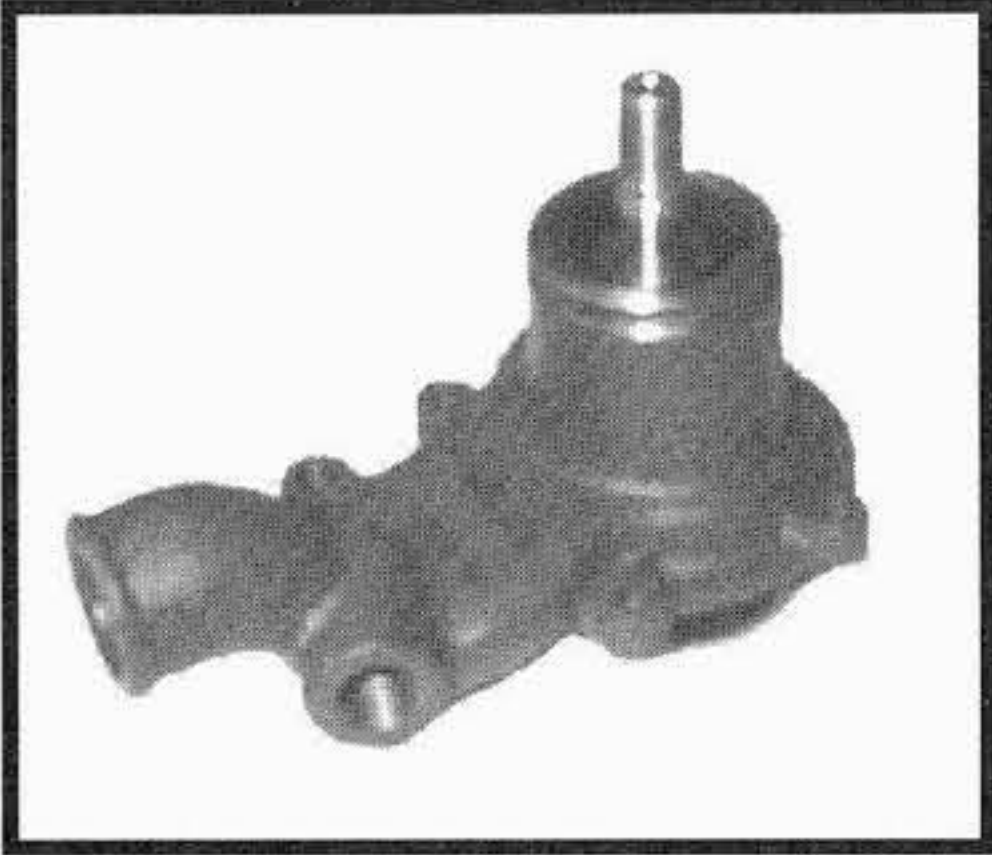
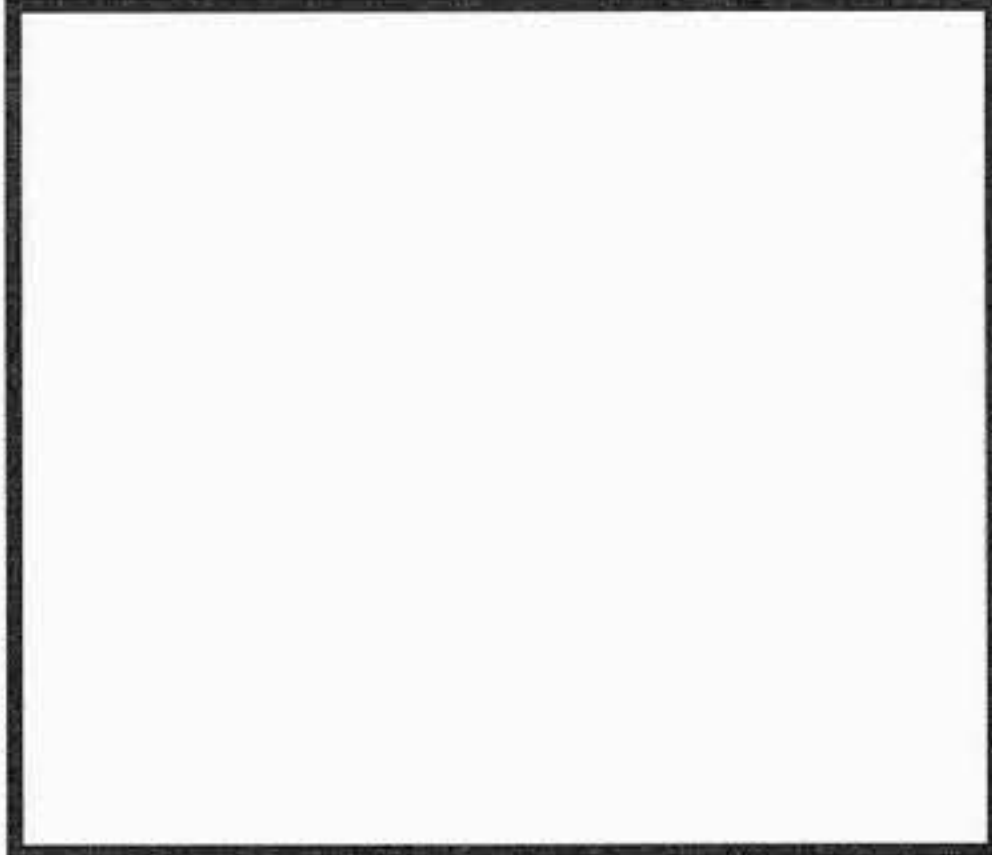
**www.spwaterpumps.co.uk**

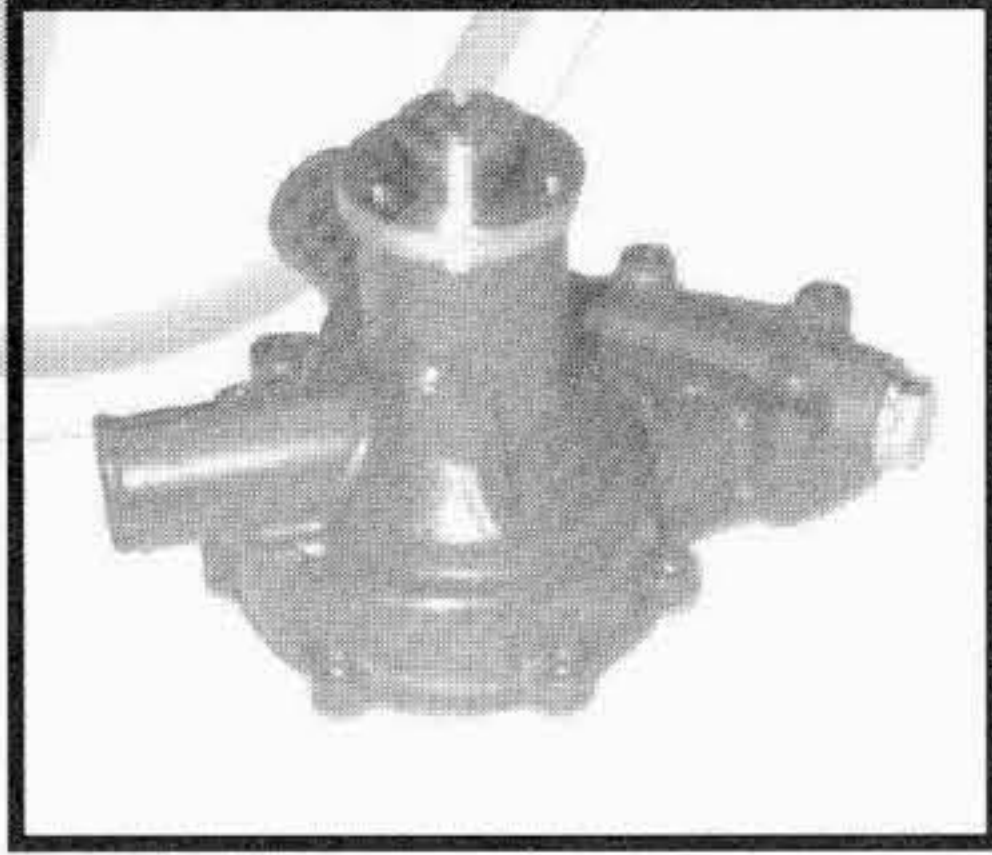

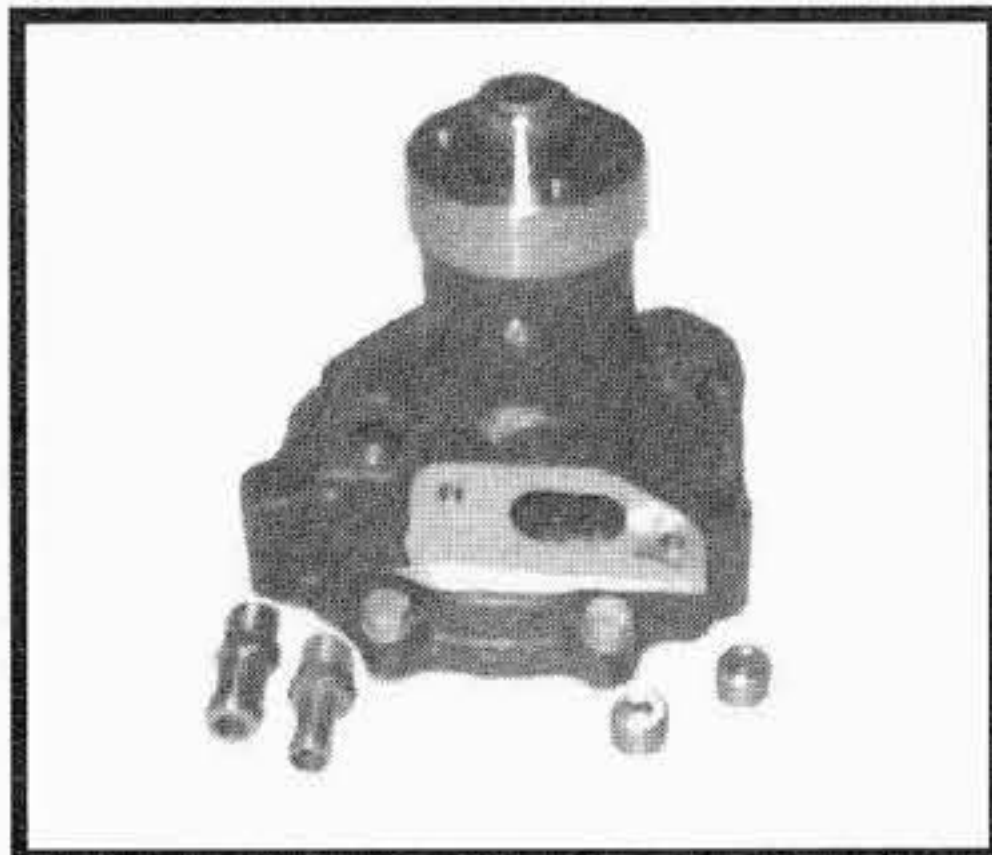
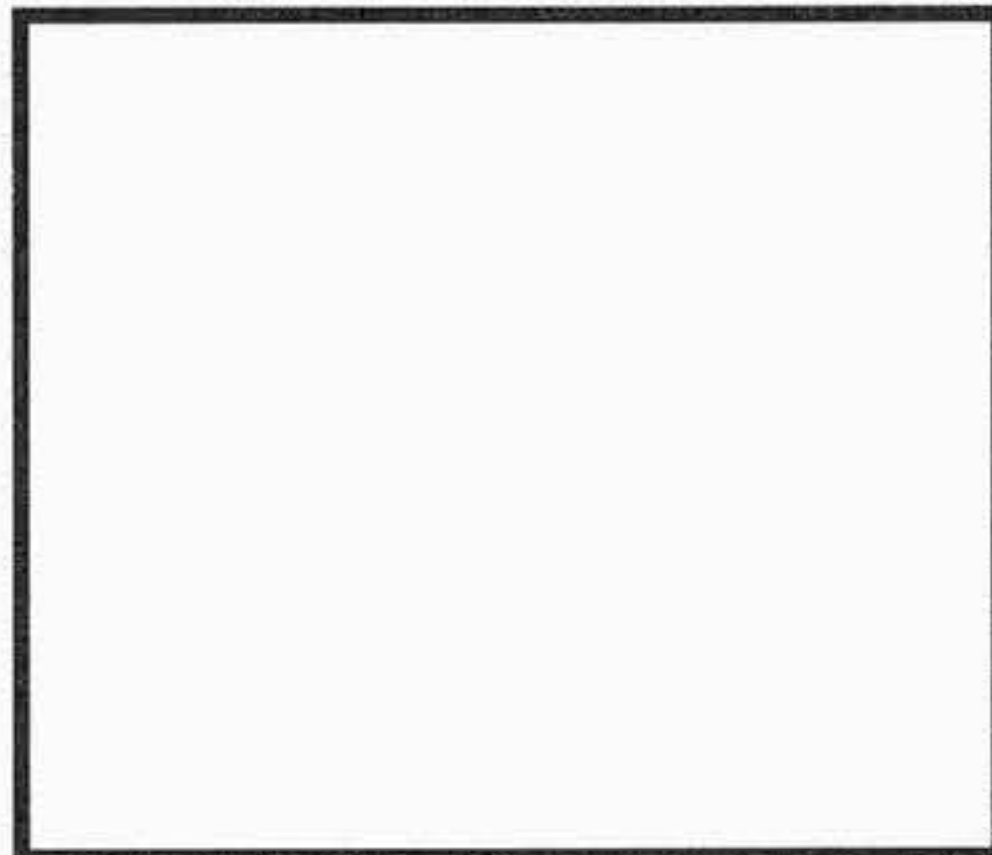
TIPO O MODELLO TYPE OU MODELE TYPE OR MODEL	MOTORE MOTEUR ENGINE	POMPA ACQUA POMPE A EAU WATER PUMP OMP REF. / O.EM. REF	KIT RIPARAZIONE NECESSAIRE DE REP. REPAIR KIT OMP REF. / O.EM. REF
M 84	4.236 - 4.248	<b>159.490</b> 4131A021 	<b>152.183</b> U7LW0032 
M 100	CO 2 D	<b>221.450</b> 577837 	<b>202.033</b> 1909625 
M 100	CO 3 / 70	<b>221.485</b> 8829787 	<b>222.262</b> 76031329 
M 112  3350  3450  3600	8065 I  8041 I  8061 I  8061 I	<b>196.319</b> 93191101 	<b>222.260</b> 76029352 

I ricambi non sono originali ma adattabili . Ogni riferimento originale é assolutamente indicativo .  
 Spare parts are not original but perfectly suitable . Every original part number has to be considered for reference purpose only .

SUITABLE

# NEW HOLLAND LAVERDA

Tel: +44(0)1925 850082 Fax: +(0)44 1925 850083

www.spwaterpumps.co.uk

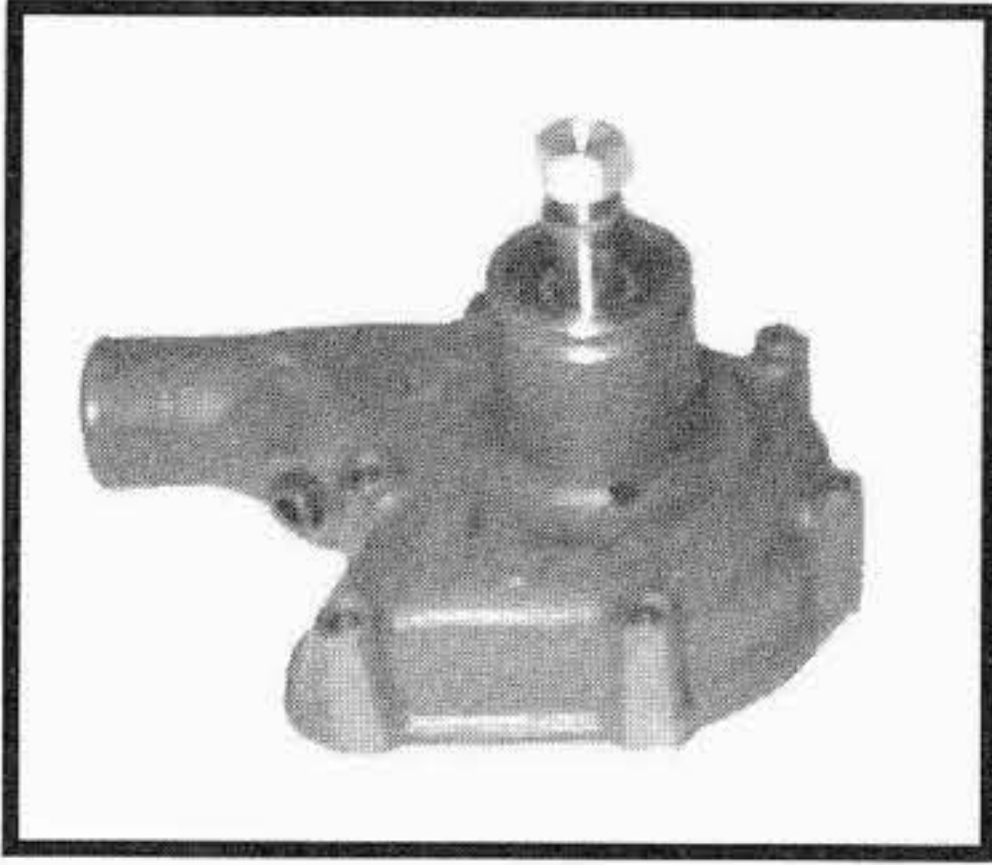
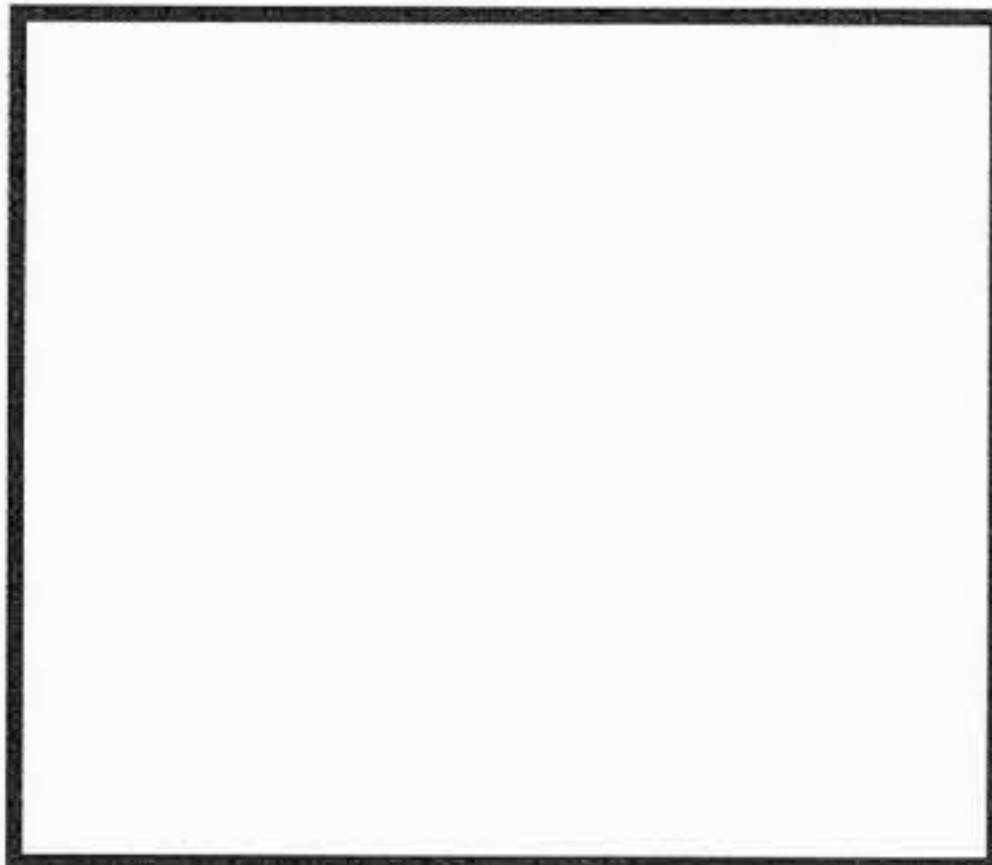
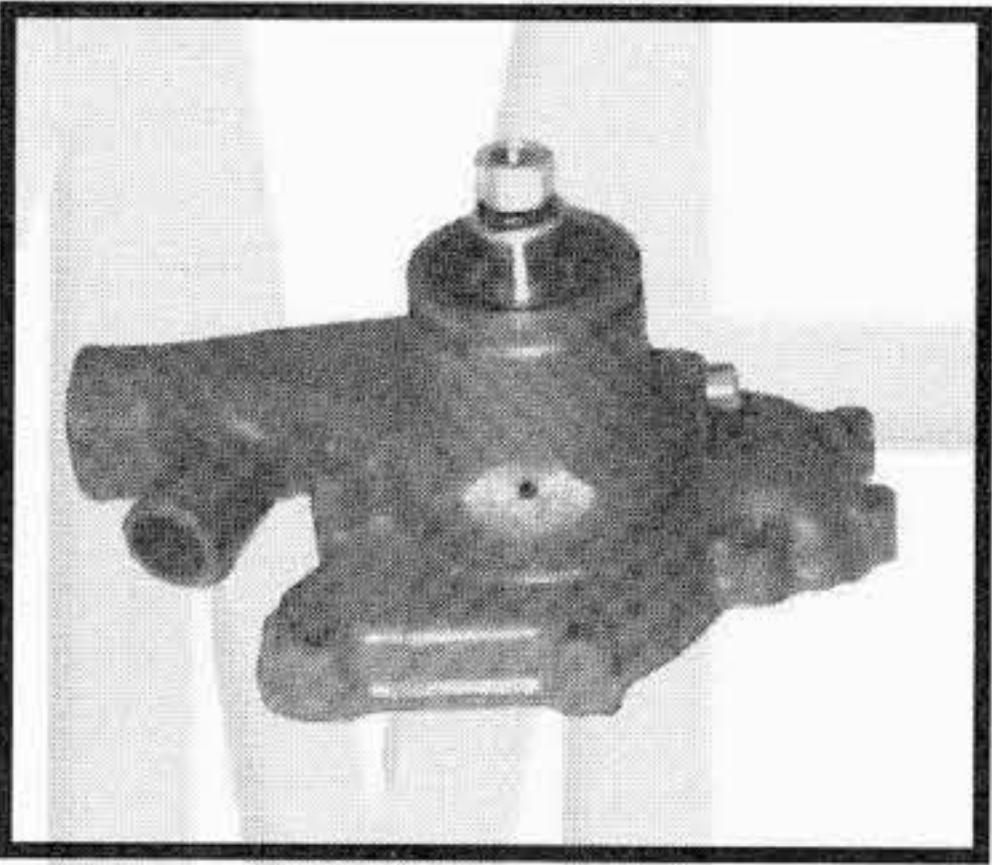
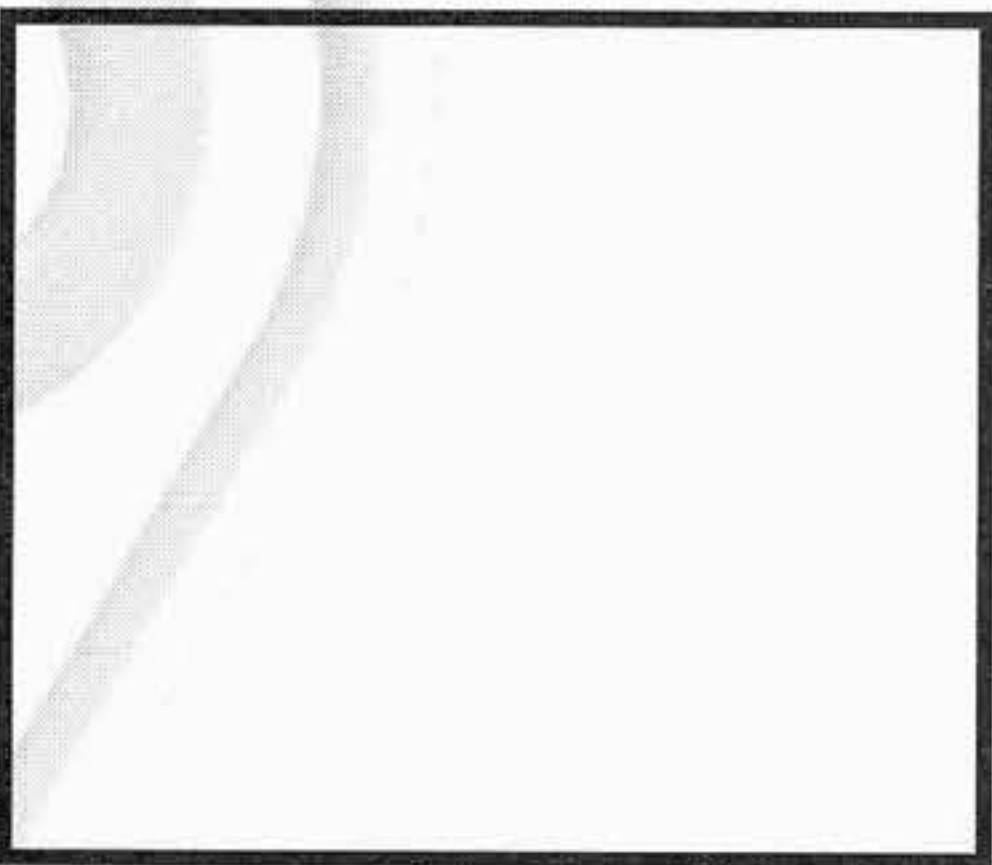
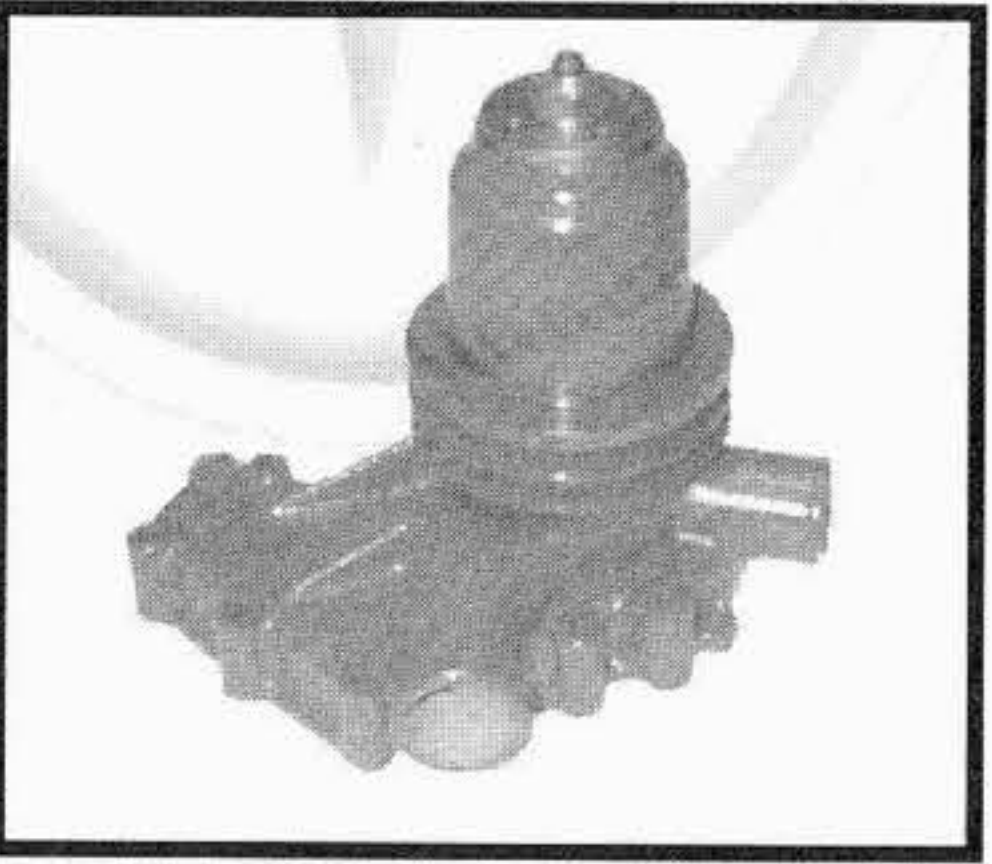
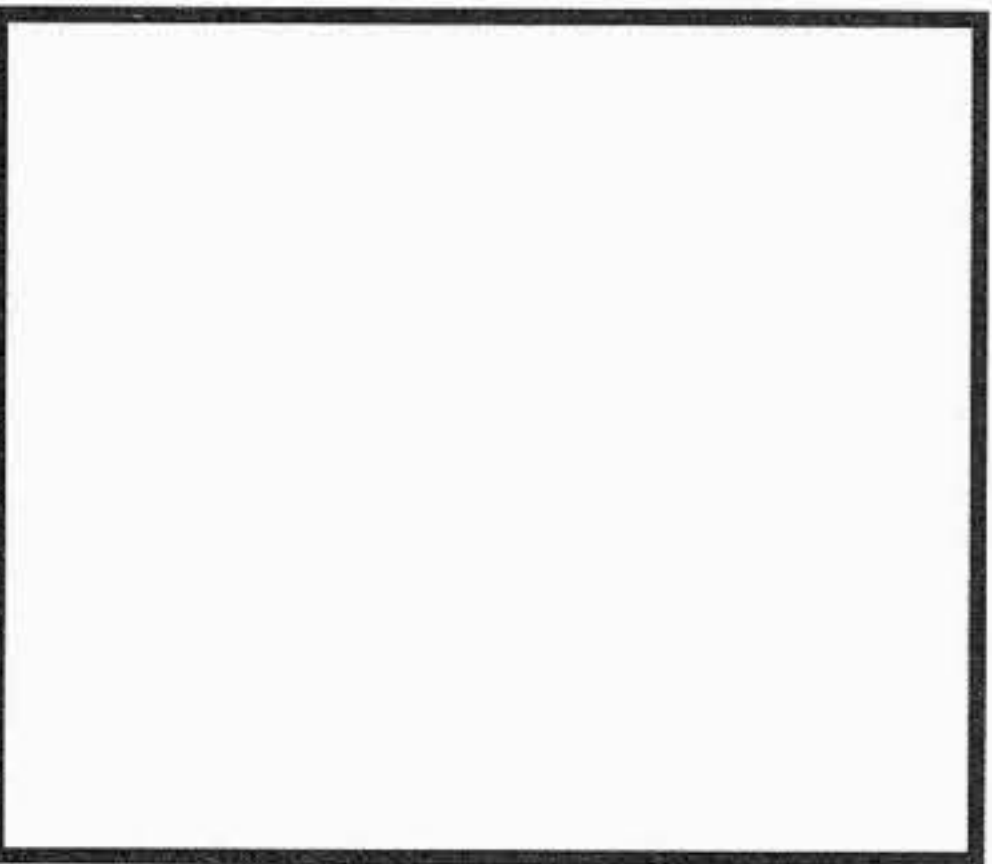
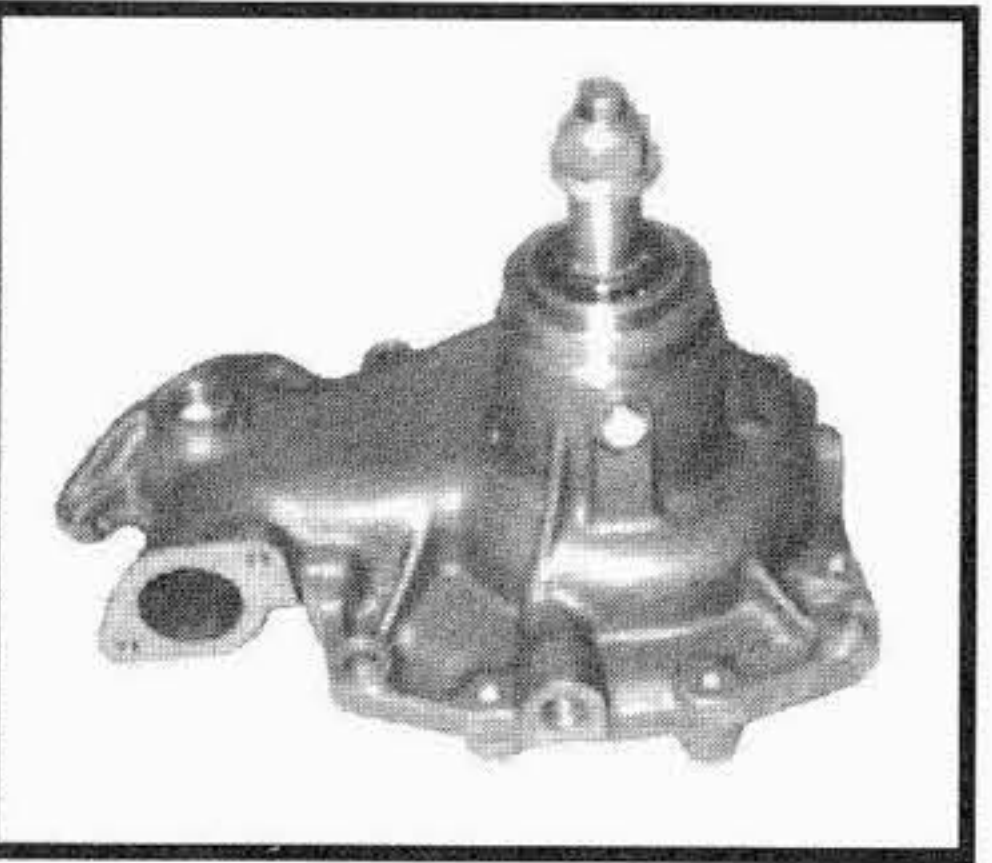
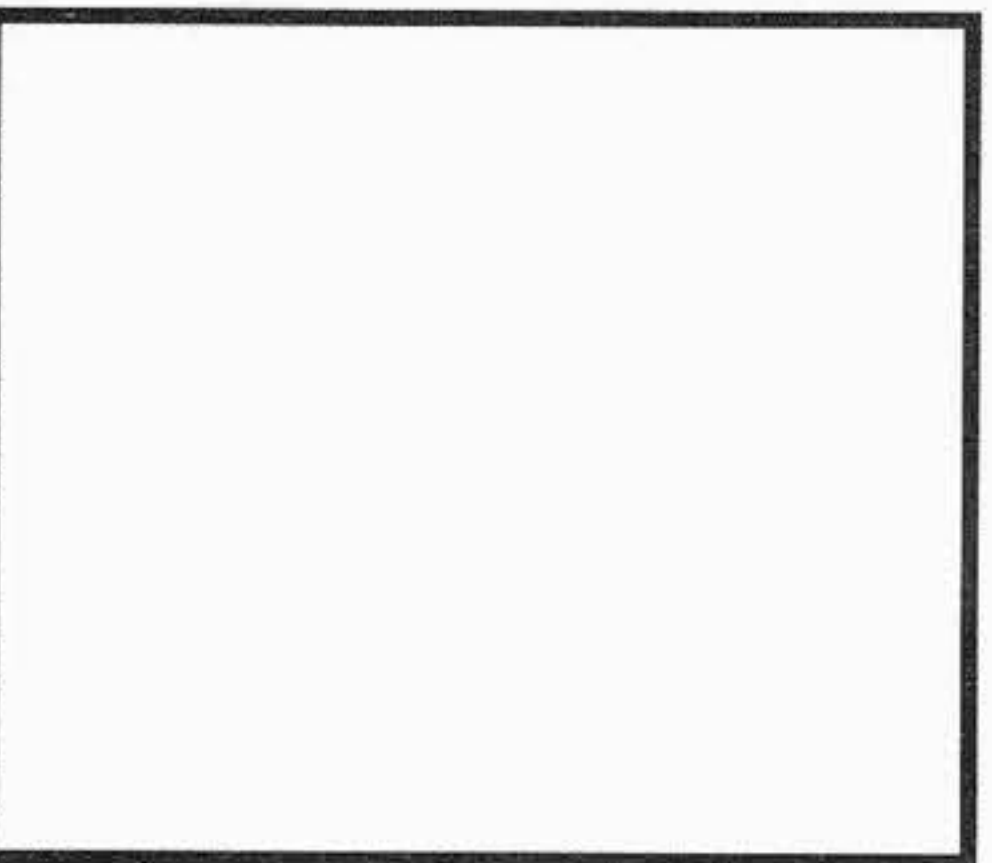

TIPO O MODELLO TYPE OU MODELE TYPE OR MODEL	MOTORE MOTEUR ENGINE	POMPA ACQUA POMPE A EAU WATER PUMP	KIT RIPARAZIONE NECESSAIRE DE REP. REPAIR KIT
		OMP REF. / O.EM. REF	OMP REF. / O.EM. REF
M 120 - M 132	6.354	<b>159.090</b> 41313045 	<b>152.097</b> U7LW0009 
M 120 - M 132	6.372.4	<b>159.260</b> 41313047 	<b>252.243</b> U7LW0020 
M 150 - M 152	CP 3 I var. 1	<b>211.520</b> 8829779 	<b>212.047</b> --- 
MX 240 - MX 240 R	8210 I 002	<b>191.300</b> 4606023 	<b>202.270</b> 76031213 

I ricambi non sono originali ma adattabili . Ogni riferimento originale é assolutamente indicativo .  
 Spare parts are not original but perfectly suitable . Every original part number has to be considered for reference purpose only .



SUITABLE

**NEW HOLLAND LAVERDA**

Tel: +44(0)1925 850082 Fax: +(0)44 1925 850083

www.spwaterpumps.co.uk

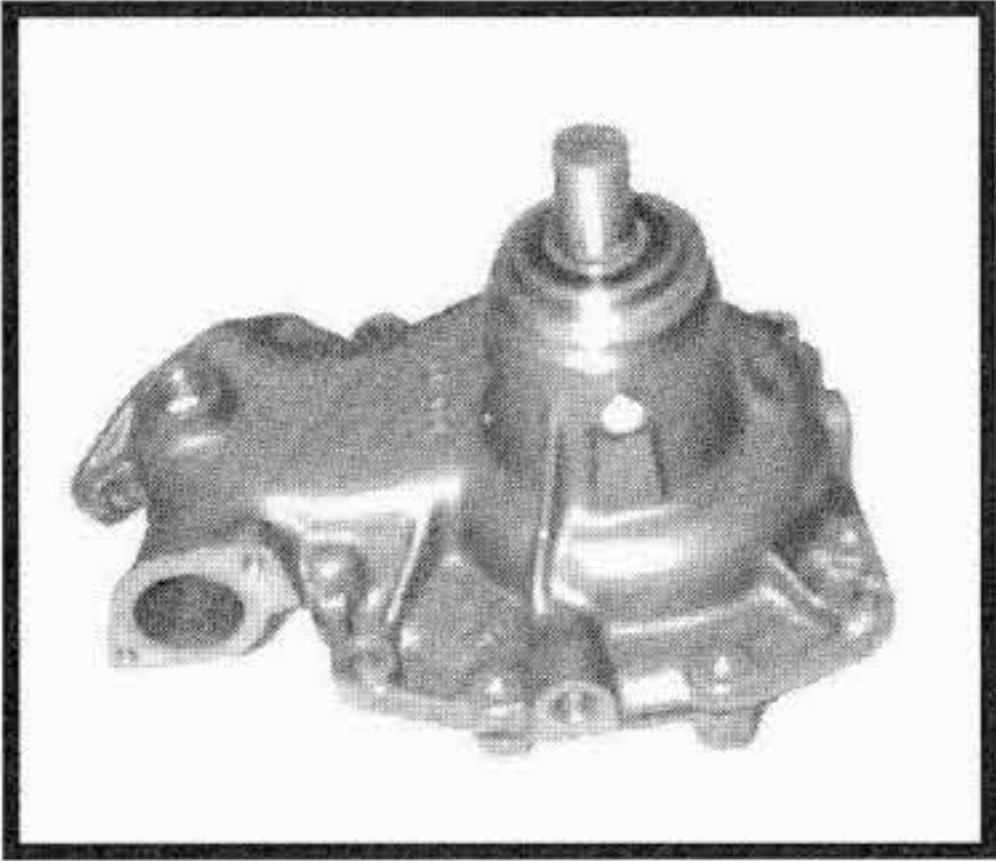
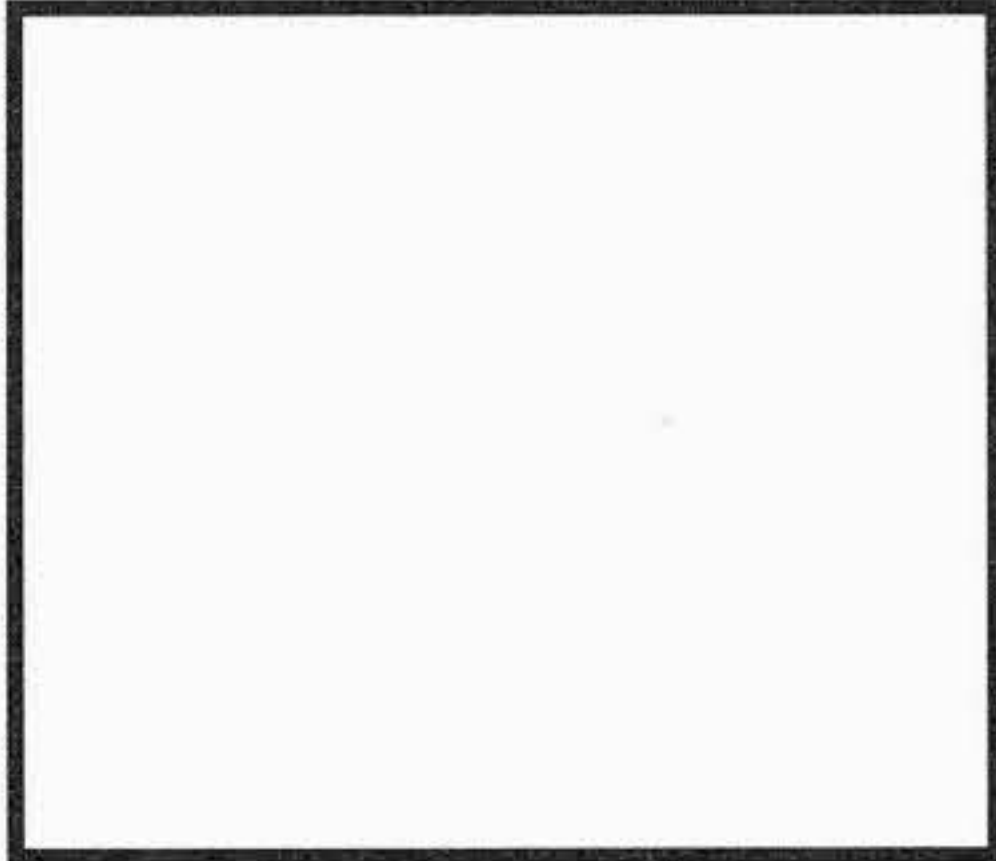

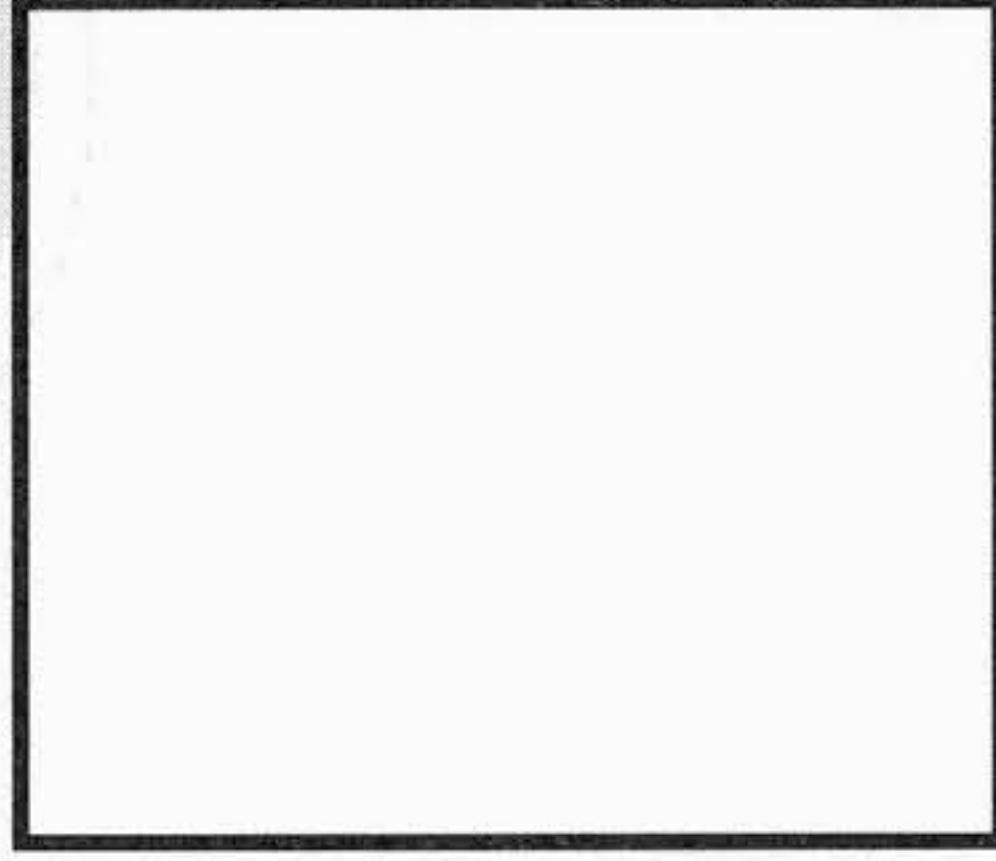
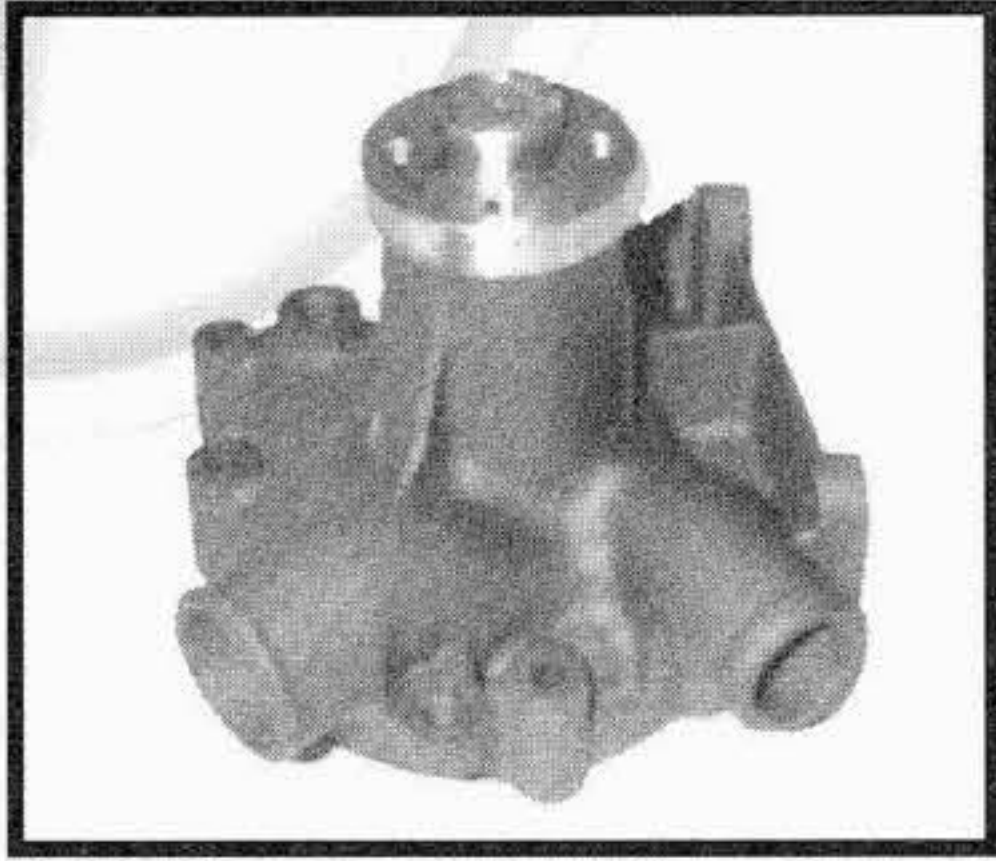
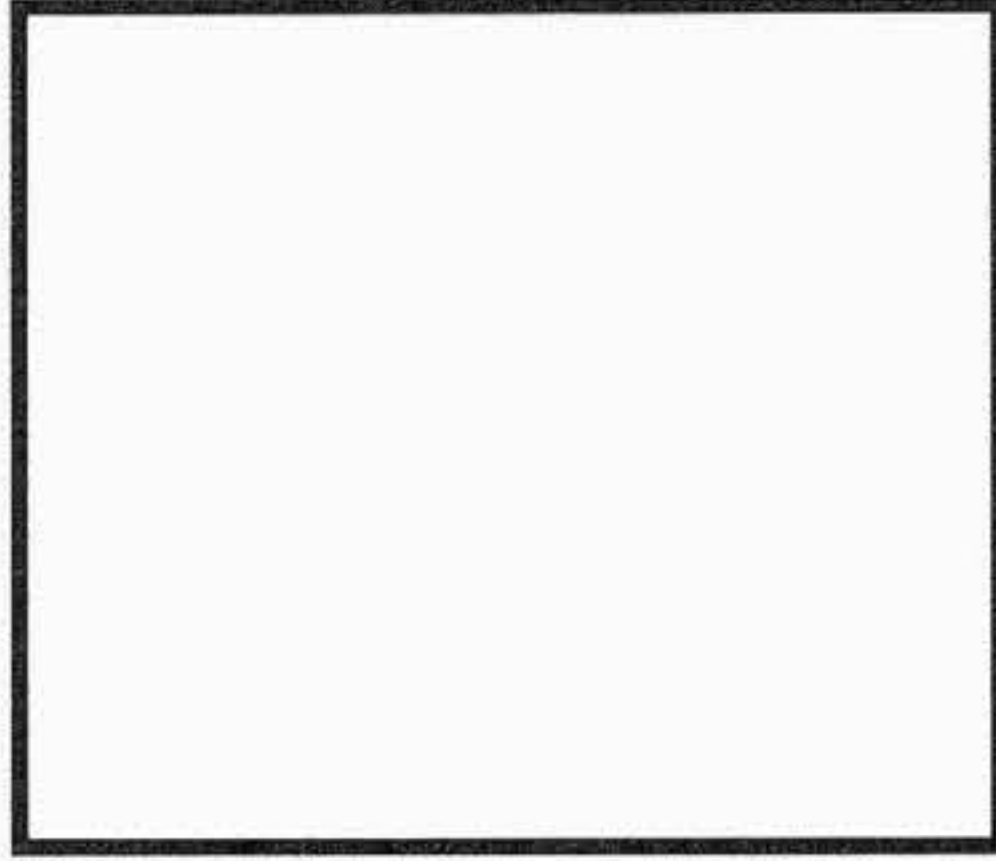
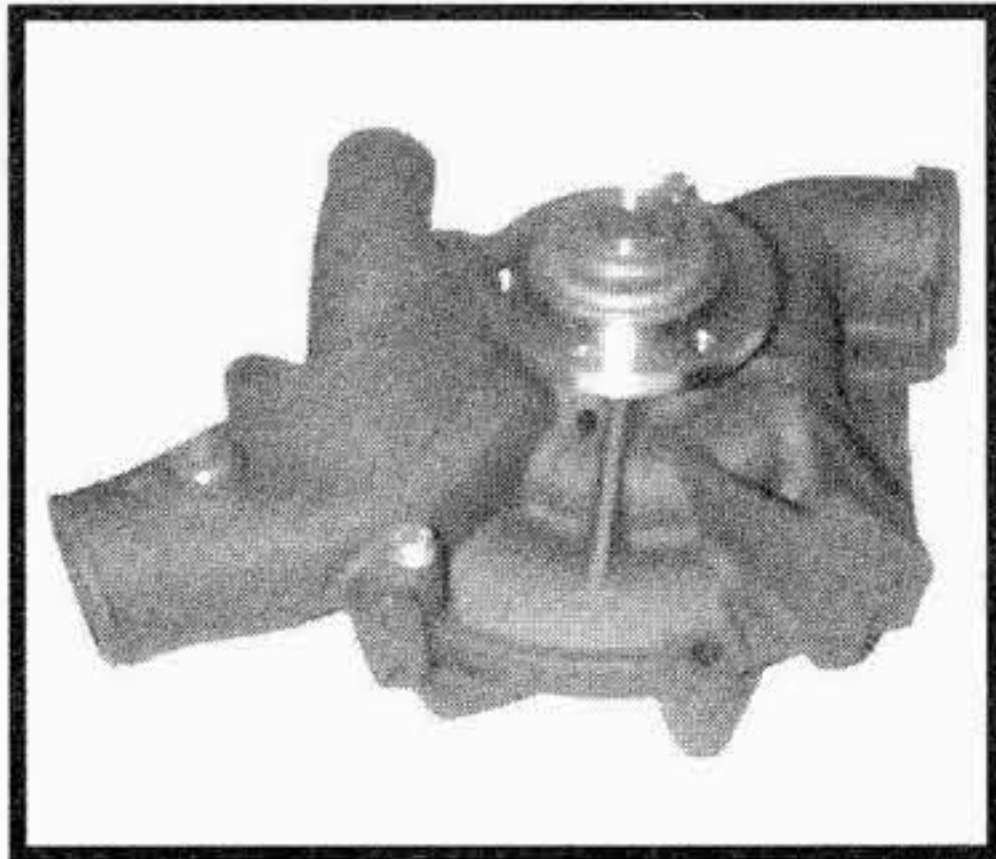
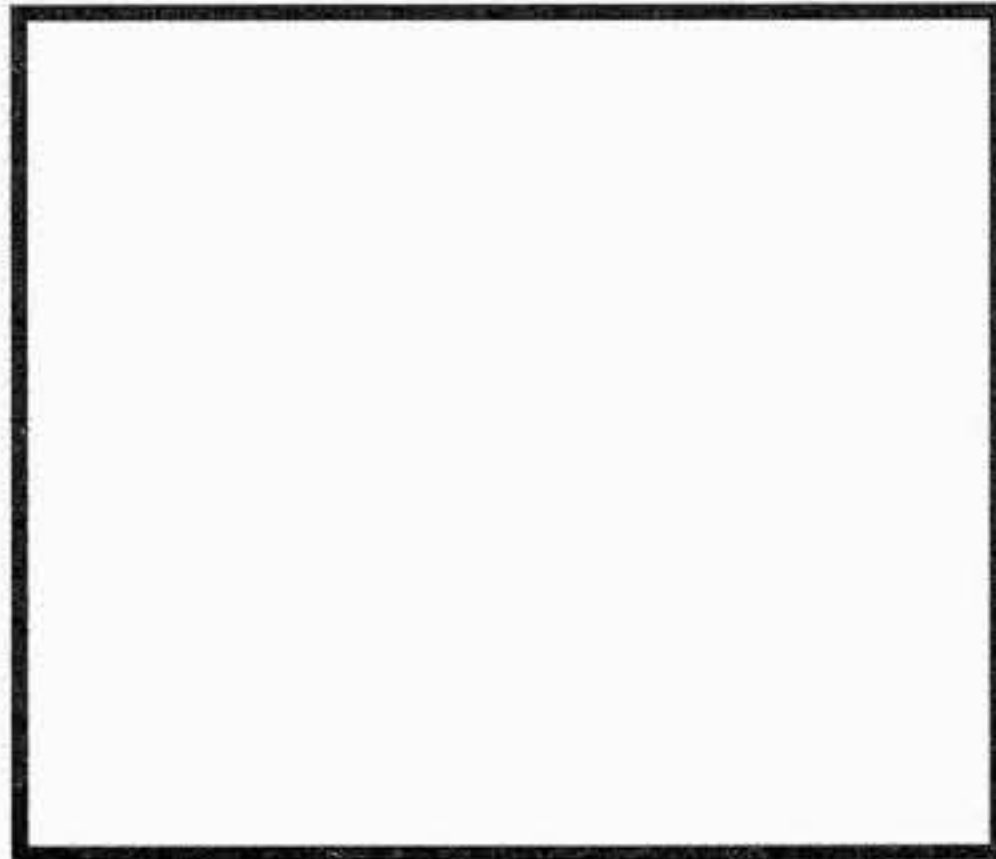
TIPO O MODELLO TYPE OU MODELE TYPE OR MODEL	MOTORE MOTEUR ENGINE	POMPA ACQUA POMPE A EAU WATER PUMP OMP REF. / O.EM. REF	KIT RIPARAZIONE NECESSAIRE DE REP. REPAIR KIT OMP REF. / O.EM. REF
MX 300 - MX 300 R	8210 SI 02	<b>191.310</b> 4710552 SENZA PULEGGIA / WITHOUT PULLEY  <b>196.355</b> 61088139 CON PULEGGIA / WITH PULLEY	<b>192.019</b> 1902655 
3300 - 3300 R 3400 - 3400 R 3500 - 3500 R 3550 - 3550 R 3550 AL 3650 - 3650 R 3750 - 3750 R	8041 I 05.004 8061 I 05.0041 8061 I 05.003 8061 SI 05.002 8061 SI 25.002 8061 SI 05.002 8061 SI 25.002	<b>206.265</b> 4813370 	<b>222.264</b> 1940105 
3700 3790 - 3790 R	8361 I 8361 SI 10.003	<b>206.200</b> 4796537 	<b>222.268</b> 1940119 
3900	8280 I	<b>196.015</b> 4764156 	<b>202.272</b> 76032965 

I ricambi non sono originali ma adattabili . Ogni riferimento originale é assolutamente indicativo .

Spare parts are not original but perfectly suitable . Every original part number has to be considered for reference purpose only .

SUITABLE

# NEW HOLLAND FORD

Tel:+44(0)1925 850082 Fax: +(0)44 1925 850083

www.spwaterpumps.co.uk

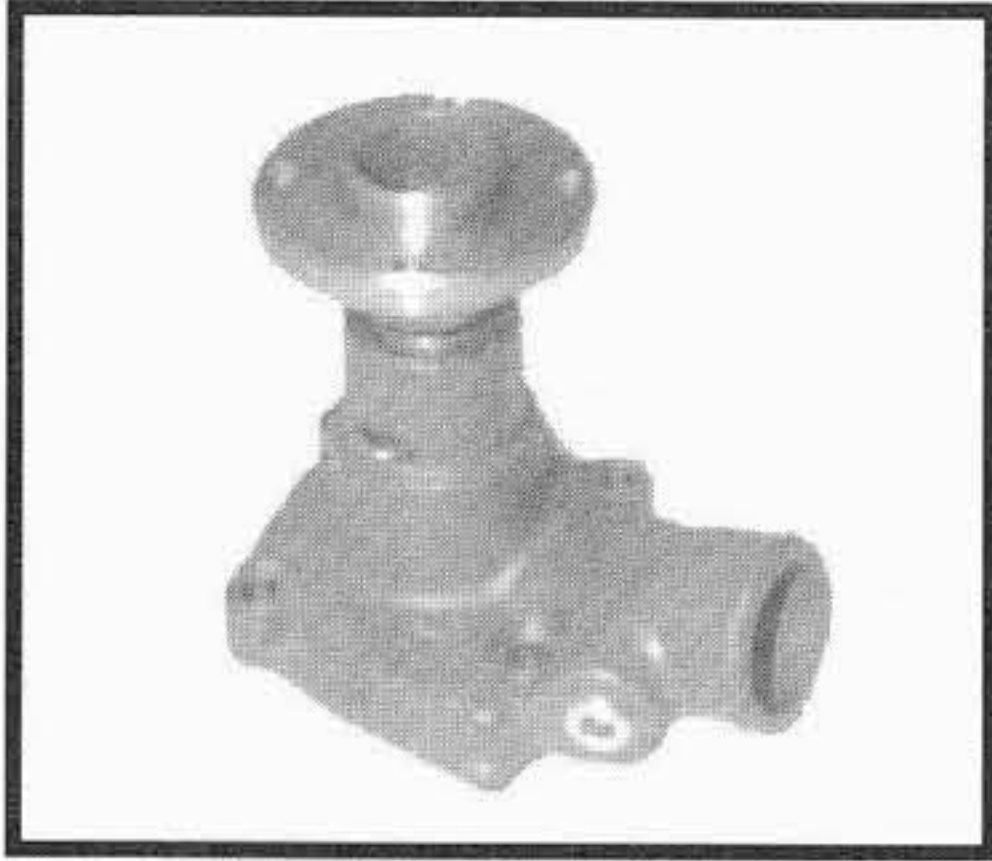
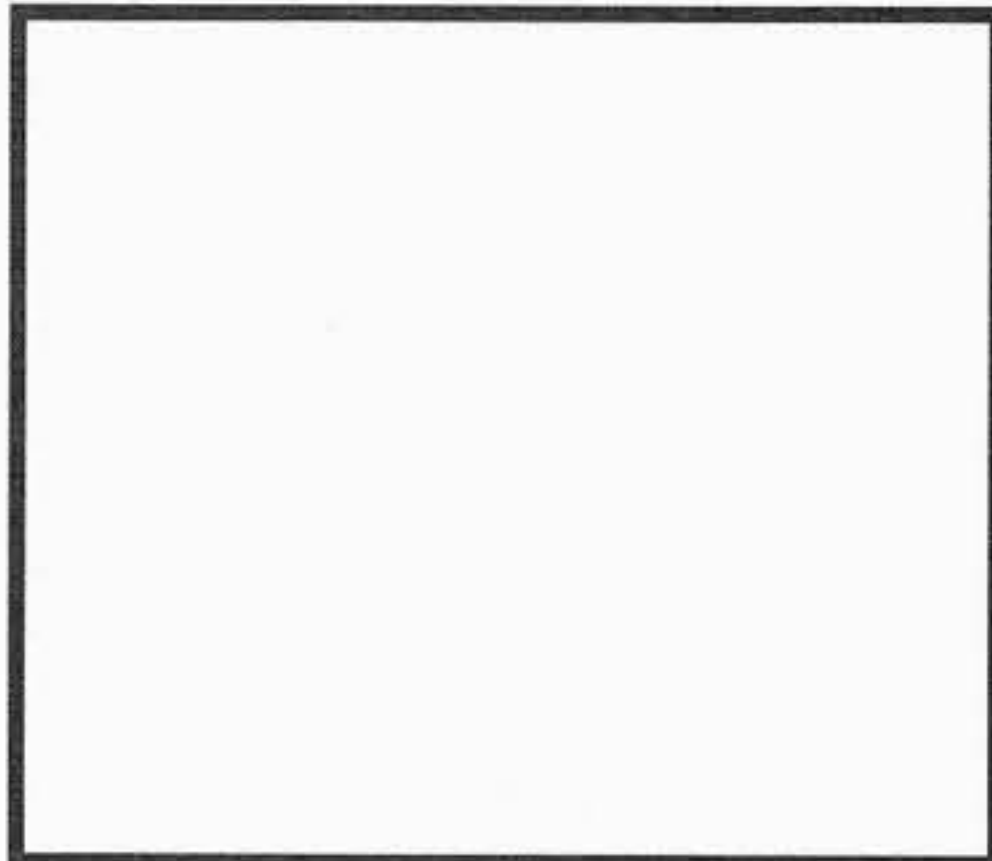
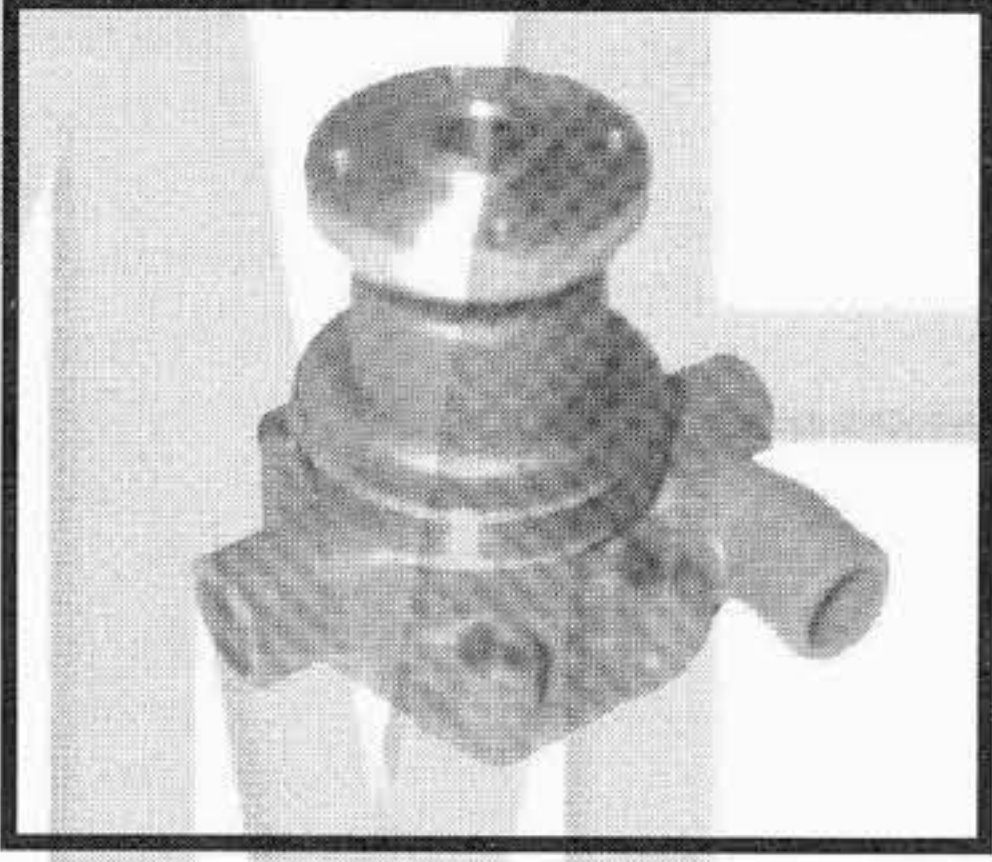
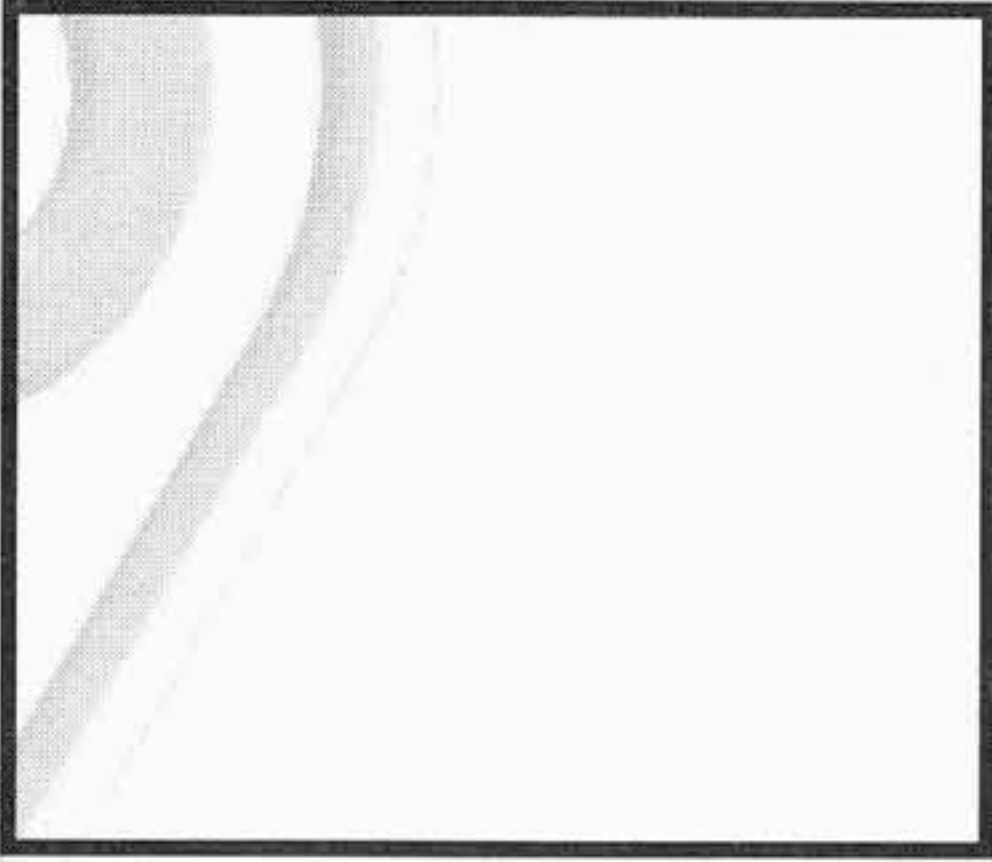
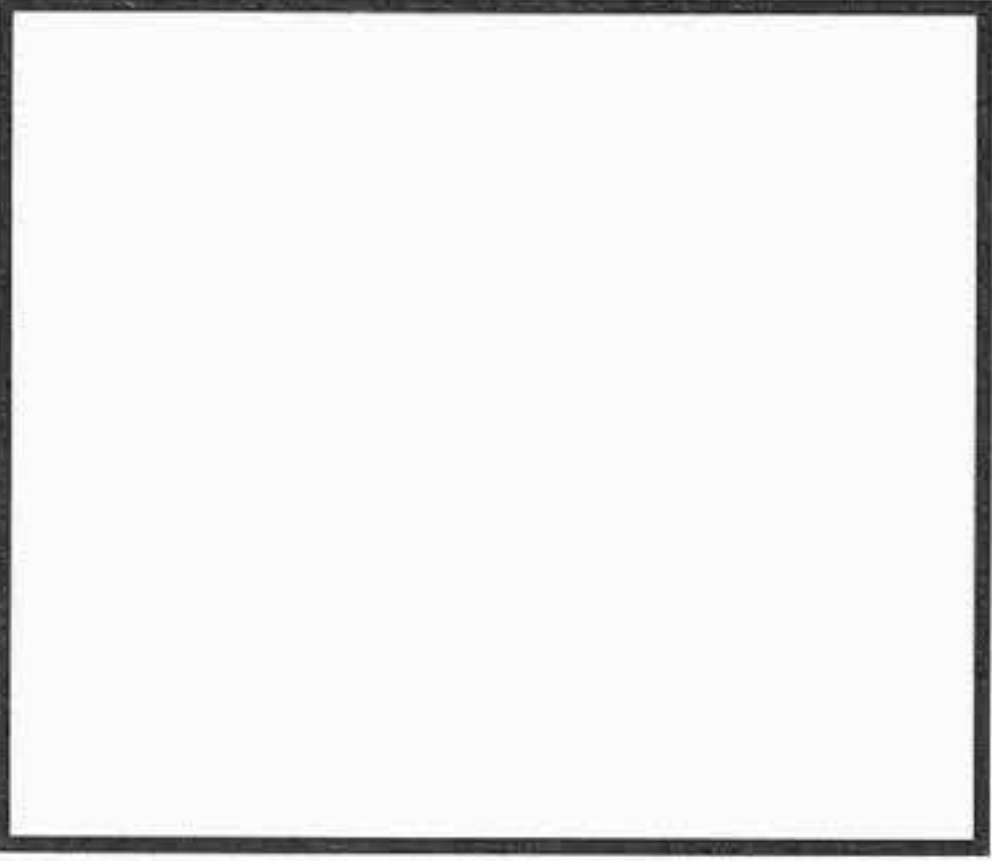
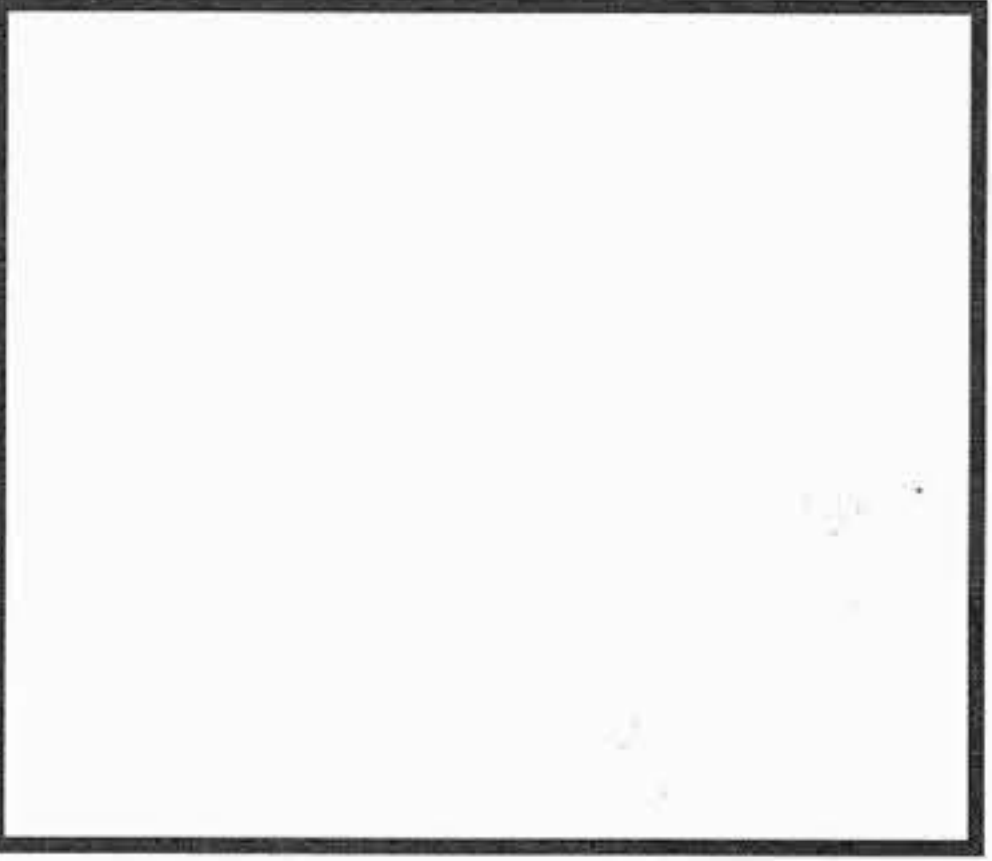

TIPO O MODELLO TYPE OU MODELE TYPE OR MODEL	MOTORE MOTEUR ENGINE	POMPA ACQUA POMPE A EAU WATER PUMP	KIT RIPARAZIONE NECESSAIRE DE REP. REPAIR KIT
MAJOR MK 1  MAJOR MK 11 (1952/1960)  SUPER MAJOR (1960/1967)	Ford	<p><b>164.010</b> E1ADKN8501C 81711728</p> 	<p><b>162.137</b> E1ADKN8591 81711772</p> 
DEXTA - SUPER DEXTA	Perkins 3.144	<p><b>164.080</b> 957E8501B CON PULEGGIA / WITH PULLEY</p>  <p><b>159.375</b> U5MW0057 SENZA PULEGGIA / WITHOUT PULLEY</p>	<p><b>162.130</b> E158Z9</p> 
2000 - 2100 - 2110 - 2120 2150 - 2300 - 2310 - 3000 3055 - 3100 - 3120 - 3150 3190 - 3300 - 3310 - 3400 3500 - 3550 - 4000 - 4100 --> 71 4110 - 4140 - 4190 - 4200 4400 - 4410 - 4500 - 5000 5100 - 5190 - 5200 - 7000 7110 - 7200	Ford 3 - 4 cyl.	<p>--- D5NN8501E CON BASAMENTO / WITH BACKPLATE</p> <div data-bbox="900 1860 1361 2262" style="border: 1px solid black; padding: 5px;"> <p>Questo complessivo pompa acqua è stato sostituito con il tipo L' Ensemble de pompe d' eau a ete remplacè par le modele This complex of water pump has been replaced by the type <b>D8NN8501UC - 164.087</b> Questa pagina resta valida per i ricambi Cette page reste valable pour les pièces de rechange . This page remain valid for the spare parts</p> </div> <p>--- DHPN8A513C SENZA BASAMENTO / WITHOUT BACKPLATE</p>	<p><b>162.147</b> DJPN8591A 83914014</p>  <p>girante / impeller Ø 89 mm</p>
2000 - 2100 - 2110 - 2120 2150 - 2300 - 2310 - 3000 3055 - 3100 - 3120 - 3150 3190 - 3300 - 3310 - 3400 3500 - 3550 - 4000 - 4100 --> 71 4110 - 4140 - 4190 - 4200 4400 - 4410 - 4500 - 5000 5100 - 5190 - 5200 - 7000 7110 - 7200  2600 - 3600 - 3900 - 4100 4600 - 5600 - 5700 - 6600 --> 81 6700 - 7600 - 7700  550 ---> 1975 / 1983	Ford 3 - 4 cyl.  Ford 3 - 4 cyl.	<p>--- D8NN8501UA CON BASAMENTO / WITH BACKPLATE</p> <div data-bbox="900 2512 1361 2914" style="border: 1px solid black; padding: 5px;"> <p>Questo complessivo pompa acqua è stato sostituito con il tipo L' Ensemble de pompe d' eau a ete remplacè par le modele This complex of water pump has been replaced by the type <b>D8NN8501UC - 164.087</b> Questa pagina resta valida per i ricambi Cette page reste valable pour les pièces de rechange . This page remain valid for the spare parts</p> </div> <p>--- DHPN8A513F SENZA BASAMENTO / WITHOUT BACKPLATE</p>	<p><b>162.148</b> EAPN8591C 83914015</p>  <p>girante / impeller Ø 104 mm</p>

I ricambi non sono originali ma adattabili . Ogni riferimento originale é assolutamente indicativo .  
 Spare parts are not original but perfectly suitable . Every original part number has to be considered for reference purpose only .

SUITABLE





**NEW HOLLAND**

**FORD**

**Tel:+44(0)1925 850082 Fax: +(0)44 1925 850083**

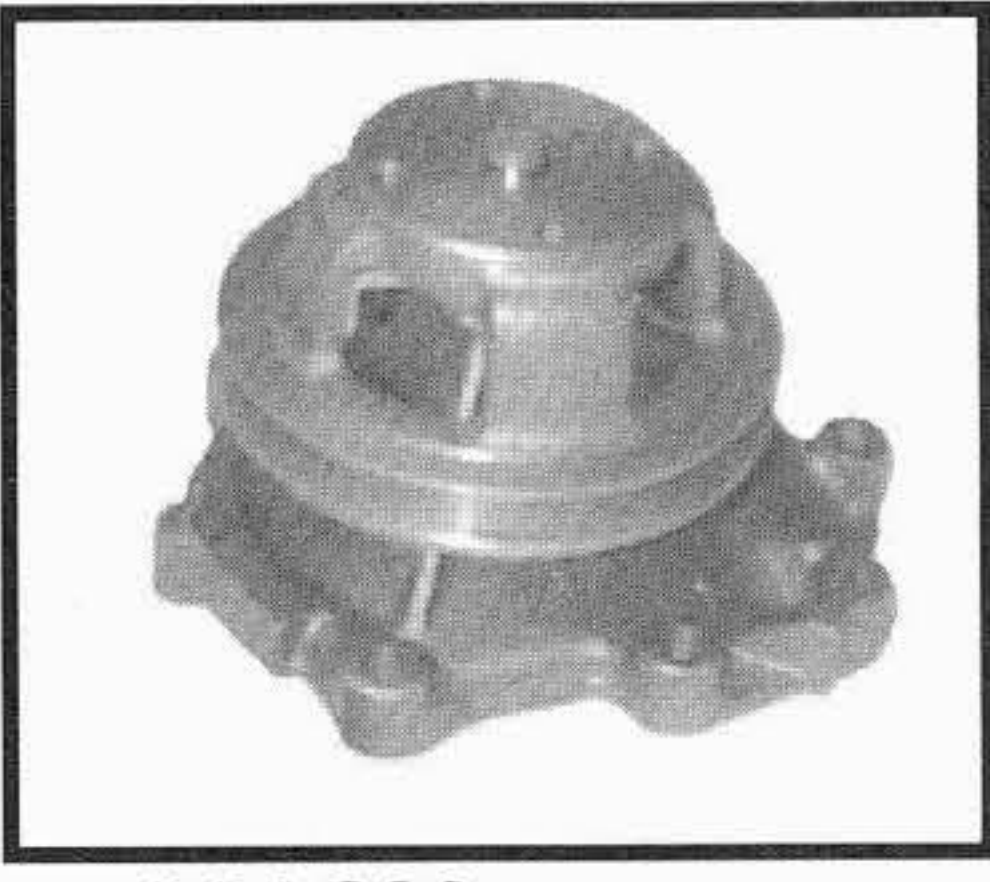
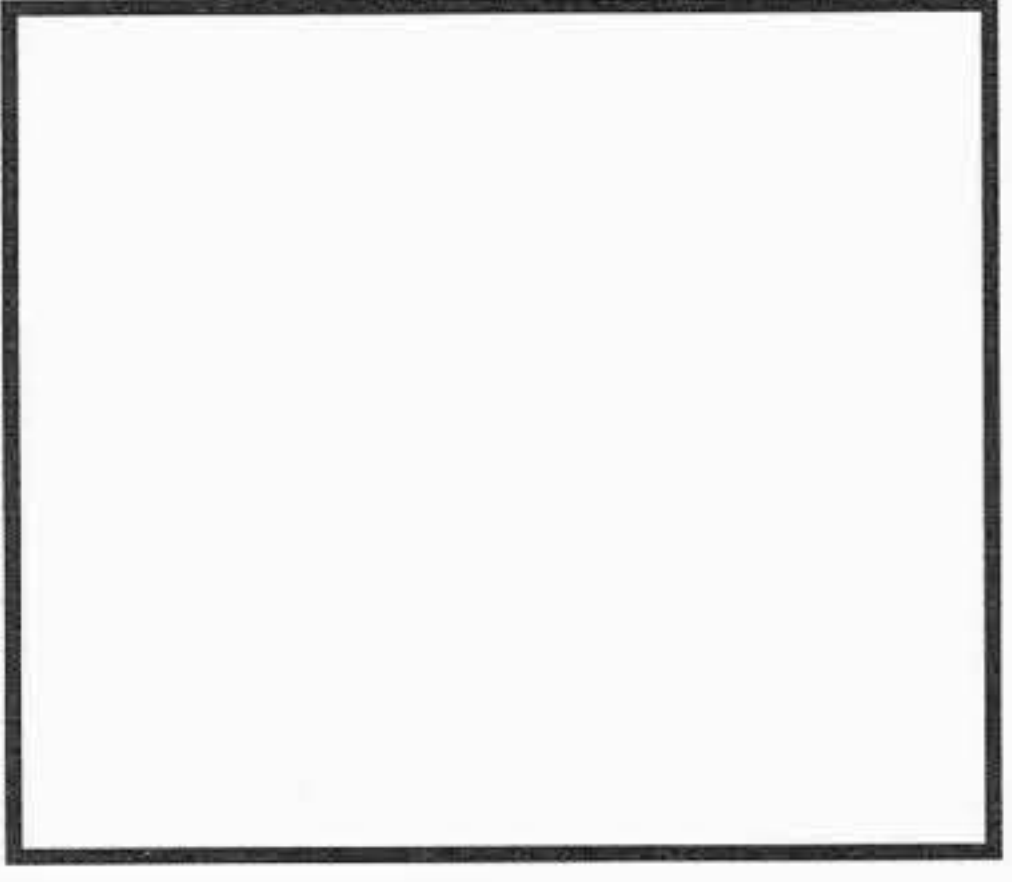
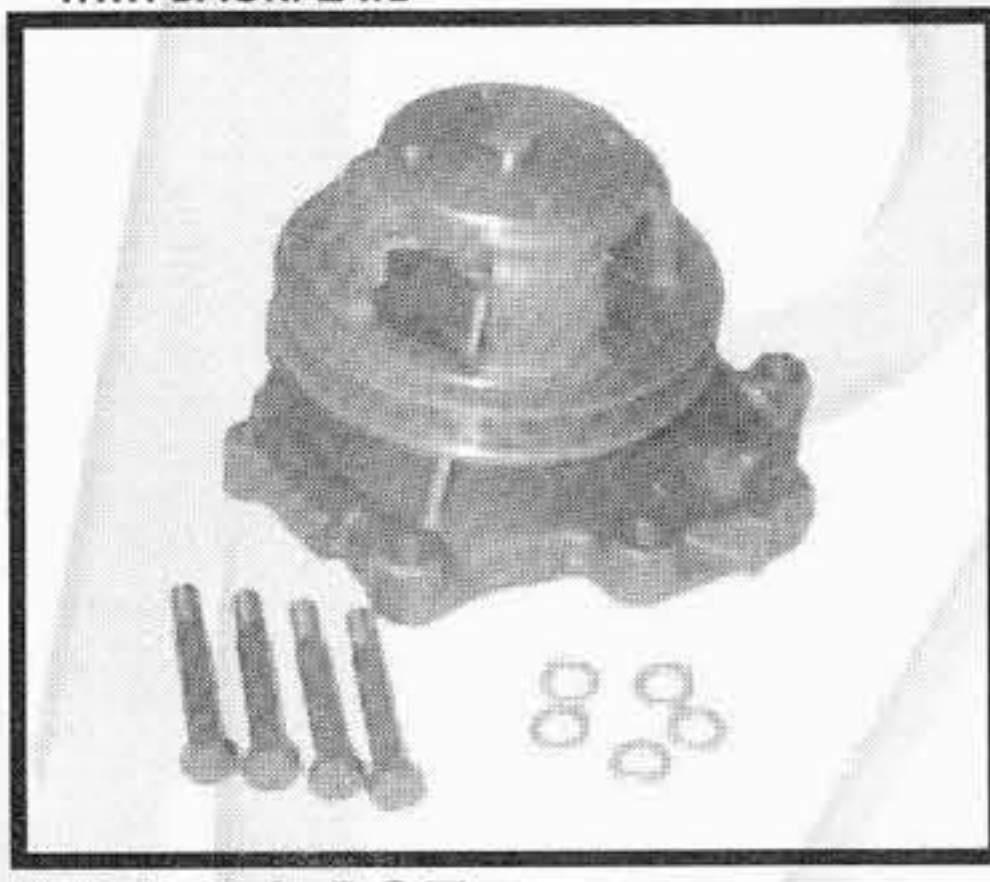
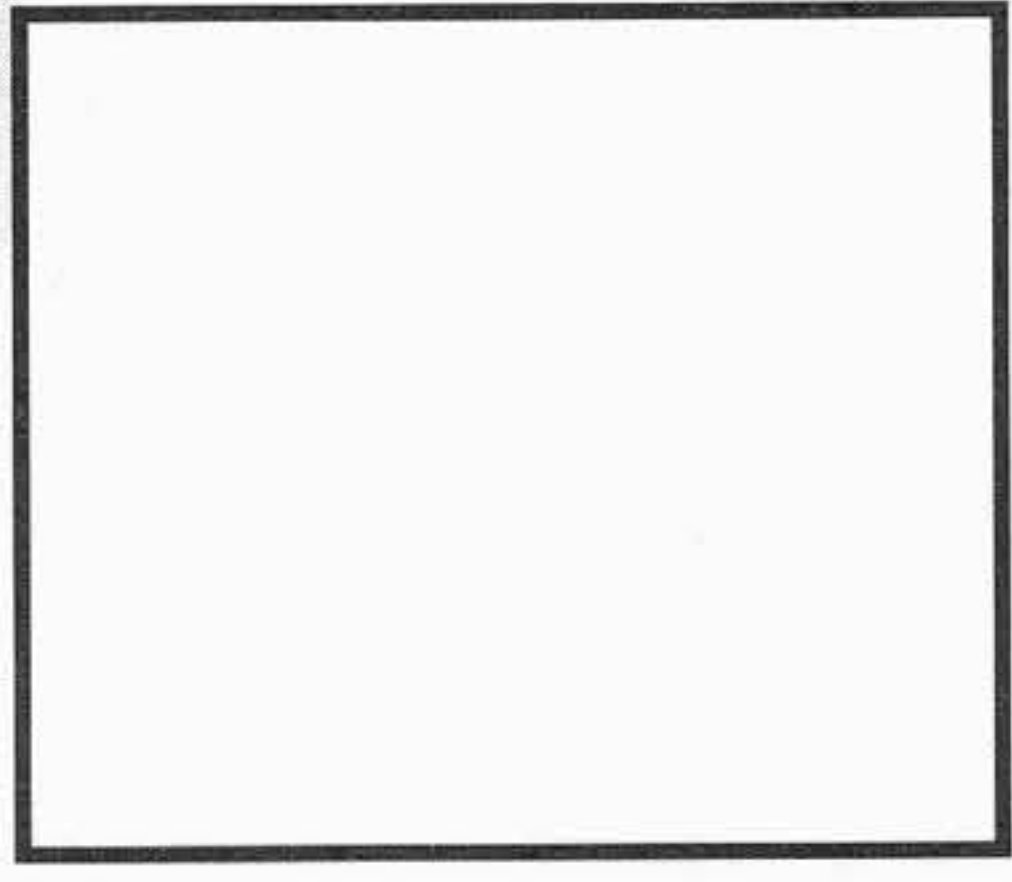
**www.spwaterpumps.co.uk**

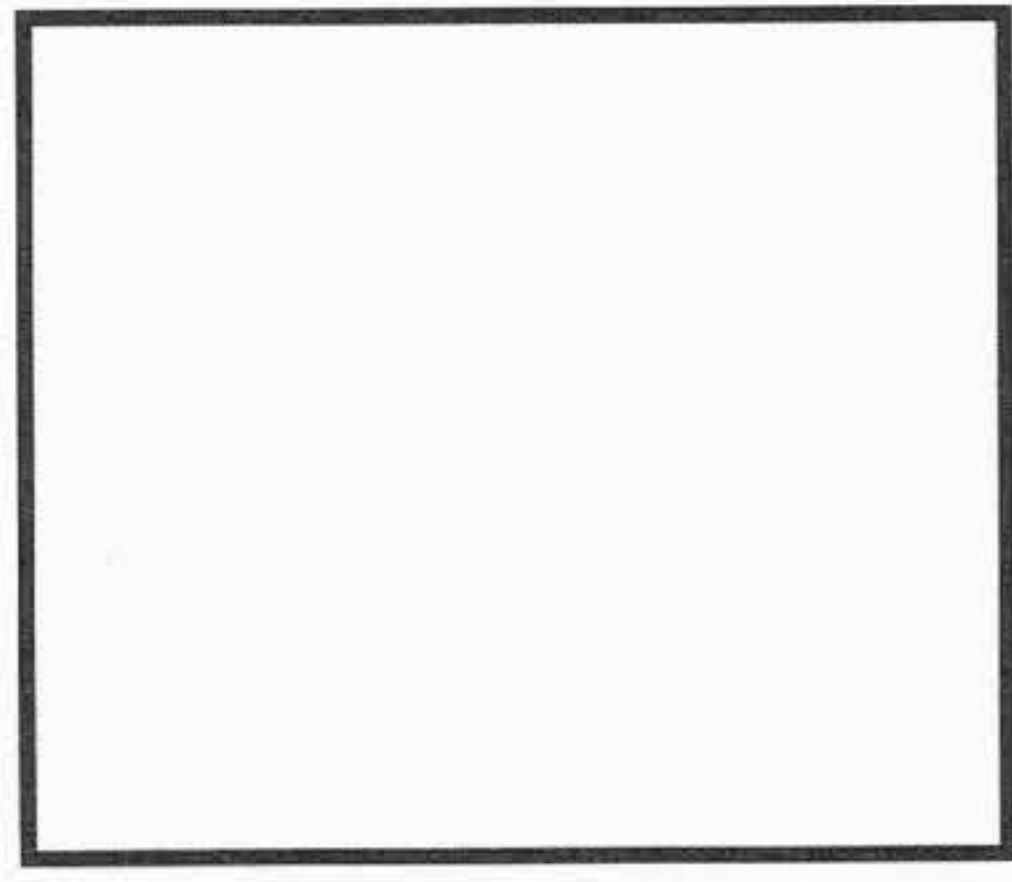

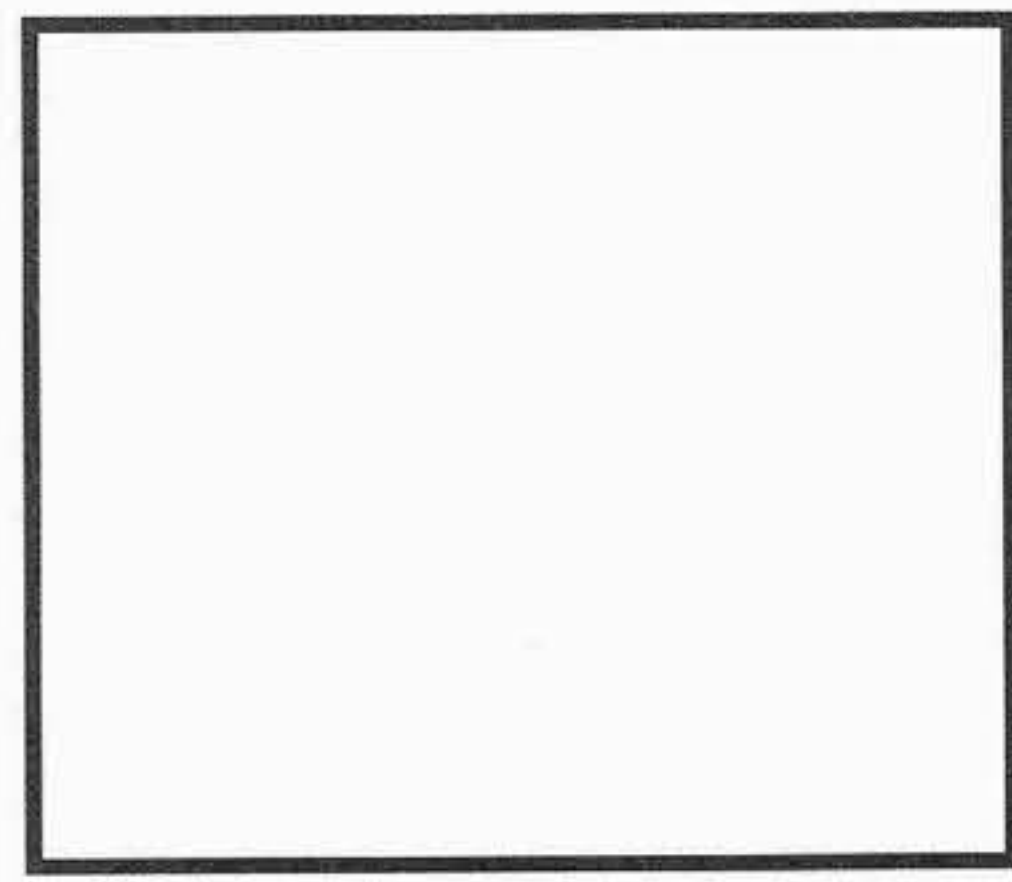
TIPO O MODELLO TYPE OU MODELE TYPE OR MODEL	MOTORE MOTEUR ENGINE	POMPA ACQUA POMPE A EAU WATER PUMP	KIT RIPARAZIONE NECESSAIRE DE REP. REPAIR KIT
<p>2000 - 2100 - 2110 - 2120 - 2150 - 2300 2310 - 3000 - 3055 - 3100 - 3120 - 3150 3190 - 3300 - 3310 - 3400 - 3500 - 3550 4000 - 4100 - 4110 - 4140 - 4190 - 4200 4400 - 4410 - 4500 - 5000 - 5100 - 5190 5200 - 7000 - 7110 - 7200</p> <p>2600 - 3600 - 3900 - 4100 - 4600 - 5600 5700 - 6600 - 6700 - 7600 - 7700</p> <p>230 A - 230 B - 231 - 233 333 - 335 - 420</p> <p>442 - 515 - 530 A - 530 B - 532 - 535</p> <p>2310 - 2610 - 2810 - 2910 - 3610 - 3910 4110 - 4610 - 5610 - 5900 - 6610 - 6710 7610 - 7710</p>	<p>Ford 3 - 4 cyl. ----&gt; <b>1971</b></p> <p>Ford 3 - 4 cyl. ----&gt; <b>1981</b></p> <p>Ford 4 cyl. ----&gt; <b>1986</b></p> <p>Ford 4 cyl.----&gt; <b>1986</b></p> <p>Ford 3 - 4 cyl. <b>1981</b> ----&gt; <b>1986</b></p>	<p><b>164.087</b> D8NN8501UC CON BASAMENTO / WITH BACKPLATE</p>  <p><b>164.088</b> EAPN8A513F 3926002 SENZA BASAMENTO / WITHOUT BACKPLATE</p>	<p><b>162.149</b> EAPN8591C 3926011</p>  <p>girante / impeller Ø 104 mm premistoppa monoblocco / monbloc seal</p>
<p>230 A - 230 B - 231 233 - 333 - 335 - 420</p> <p>442 - 515 - 530 A 530 B - 532 - 535</p> <p>2310 - 2610 - 2810 - 2910 - 3610 3910 - 4110 - 4610 - 5610 - 5900 6610 - 6710 - 7610 - 7710</p> <p>3230 - 3430 - 3930</p> <p>4130 - 4630 - 5030</p>	<p>Ford 4 cyl. <b>1987</b> ----&gt;</p> <p>Ford 4 cyl. <b>1987</b> ----&gt;</p> <p>Ford 3 - 4 cyl. <b>1987</b> ---&gt;</p> <p><b>3 / 90</b> ---&gt;</p>	<p><b>164.106</b> E6NN8501DC CON BASAMENTO / WITH BACKPLATE <b>81872277</b></p>  <p><b>164.107</b> E6NN8A513DC 81863898 SENZA BASAMENTO / WITHOUT BACKPLATE</p>	<p><b>162.150</b> EGP8591DA 83956729</p> 
<p>A 62</p> <p>230 A - 230 B - 231 <b>with air conditioning</b> ----&gt; <b>1986</b> 233 - 333 - 335 - 420</p> <p>444 T - 515 - 530 A <b>with air conditioning</b> ----&gt; <b>1986</b> 530 A - 532 - 535</p> <p>550 - 555 - 655 - 755</p> <p>2400 - 3600 - 3900 4100 - 4600 - 5600 <b>with air conditioning</b> --&gt; <b>81</b> 5700 - 6600 - 6700 7600 - 7700</p> <p>2310 - 2610 - 2810 - 2910 3610 - 3910 - 4110 - 4610 <b>with air conditioning</b> <b>81</b> --&gt; <b>86</b> 5110 - 5610 - 5900 - 6610 6710 - 7610 - 7710</p>	<p>Ford 4 cyl.</p> <p>Ford 4 cyl.</p> <p>Ford 4 cyl.</p> <p>Ford 4 cyl.</p> <p>Ford 4 cyl.</p>	<p><b>164.091</b> D8NN8501TC CON BASAMENTO / WITH BACKPLATE</p>  <p><b>164.092</b> EAPN8A513E 3926001 SENZA BASAMENTO / WITHOUT BACKPLATE</p>	<p><b>162.200</b> EAPN8591D 83956725</p> 
<p>230 A - 230 B - 231 <b>with air conditioning</b> <b>1987</b> ---&gt; 233 - 333 - 335 - 420</p> <p>444 T - 515 - 530 A <b>with air conditioning</b> <b>1987</b> ---&gt; 530 A - 532 - 535</p> <p>2310 - 2610 - 2810 - 2910 - 3610 3910 - 4110 - 4610 - 5610 - 5900 <b>with air conditioning</b> <b>1987</b> ---&gt; 6610 - 6710 - 7610 - 7710</p> <p><b>Serie M</b></p> <p>M100 - M115 - M135 - M160</p>	<p>Ford 4 cyl.</p> <p>Ford 4 cyl.</p> <p>7450 4 cyl. - 5000 cc</p> <p>7675 - 7675T 6 cyl. - 7500 cc</p>	<p><b>164.113</b> E6NN8501CA CON BASAMENTO / WITH BACKPLATE <b>81876233</b></p>  <p><b>164.114</b> EGP8A513CA 81863837 SENZA BASAMENTO / WITHOUT BACKPLATE</p>	<p><b>162.151</b> EGP8591CA 81863952</p> 

I ricambi non sono originali ma adattabili . Ogni riferimento originale é assolutamente indicativo .  
Spare parts are not original but perfectly suitable . Every original part number has to be considered for reference purpose only .





SUITABLE

# NEW HOLLAND FORD

Tel: +44(0)1925 850082 Fax: +(0)44 1925 850083

www.spwaterpumps.co.uk

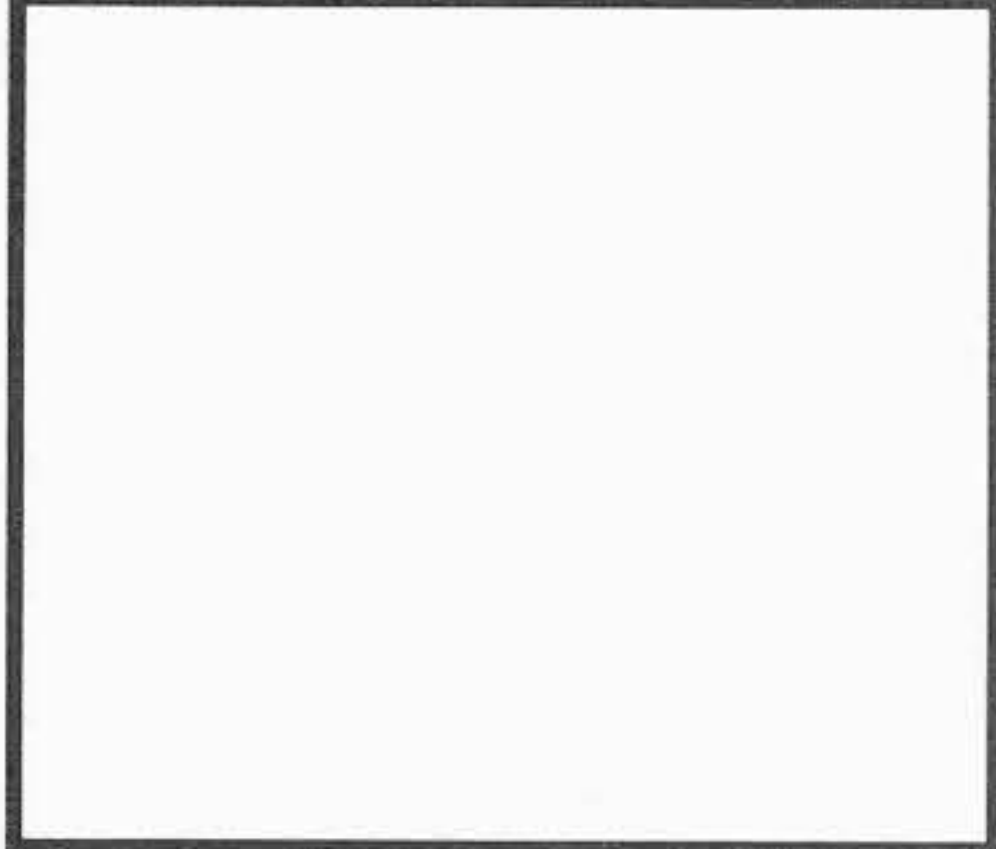
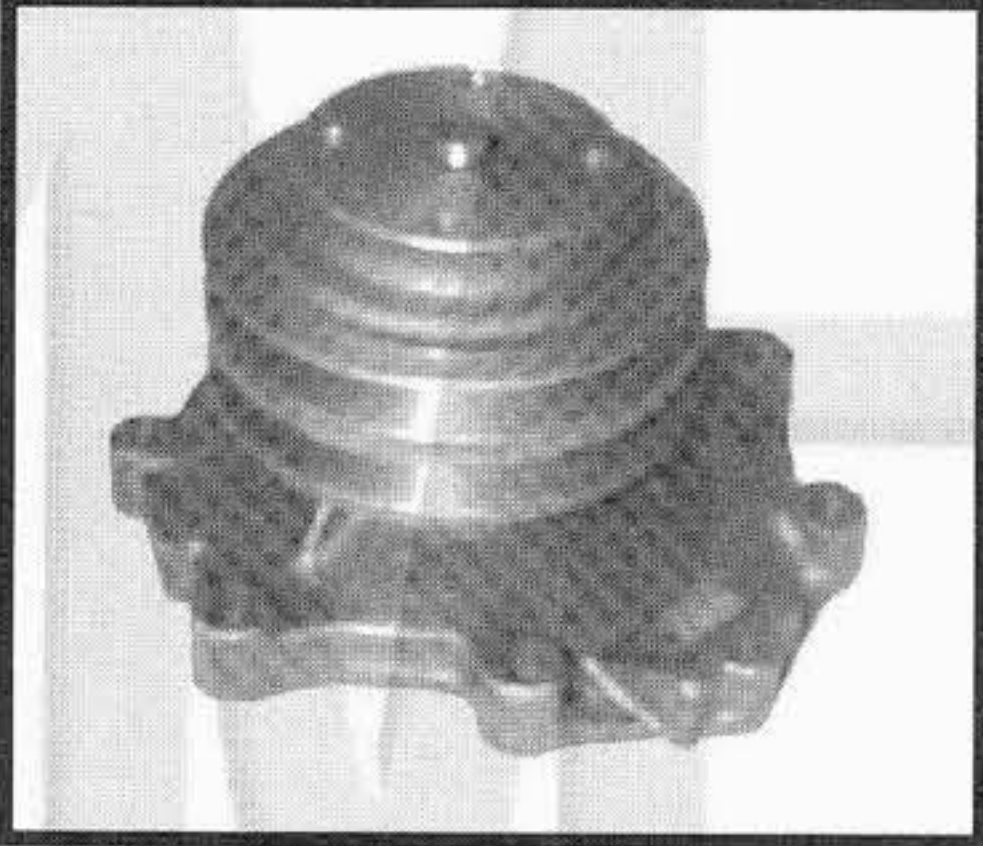
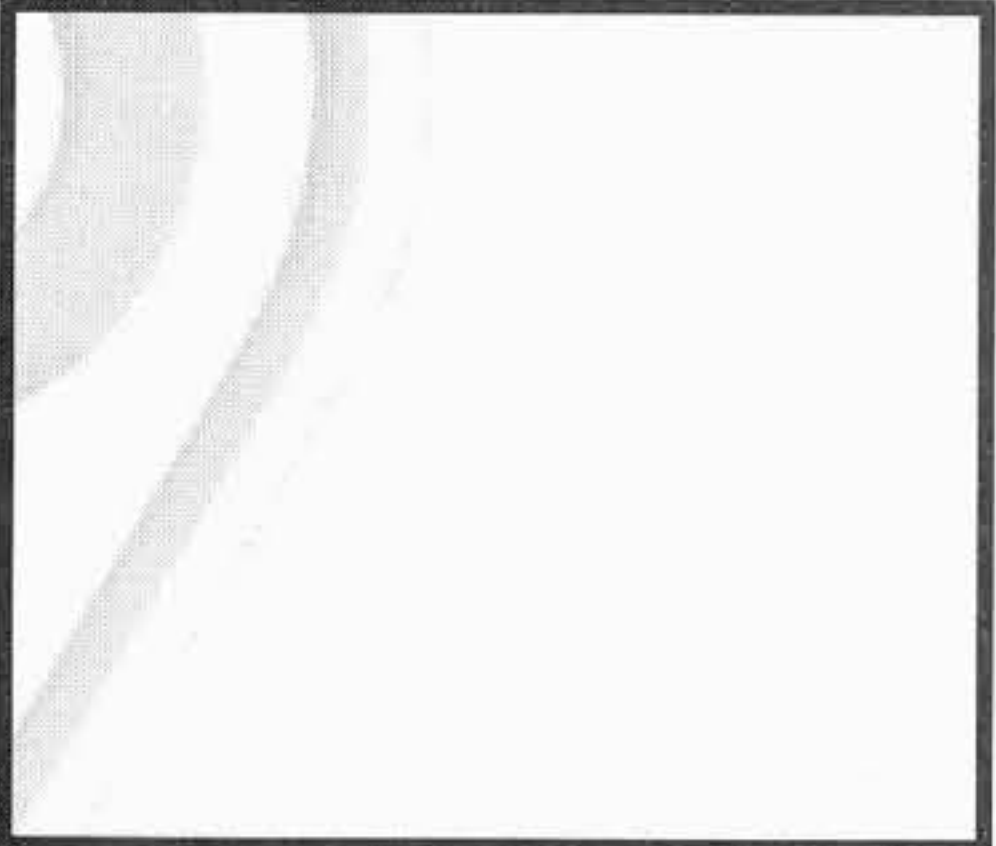
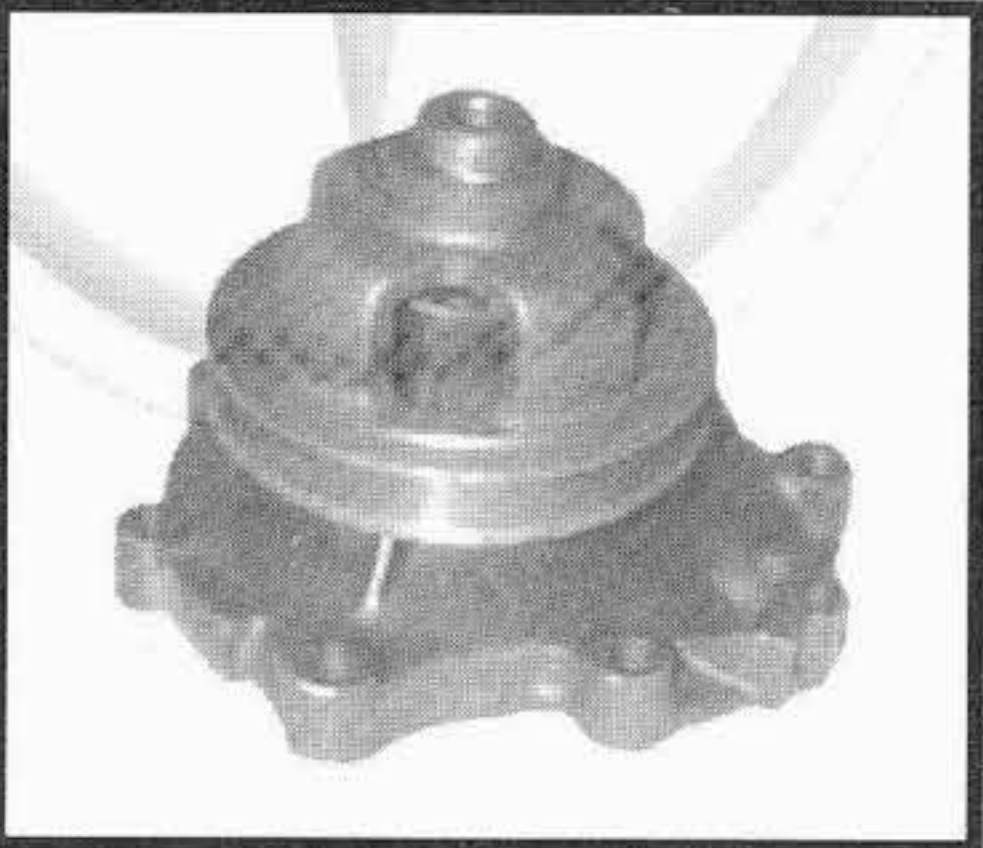
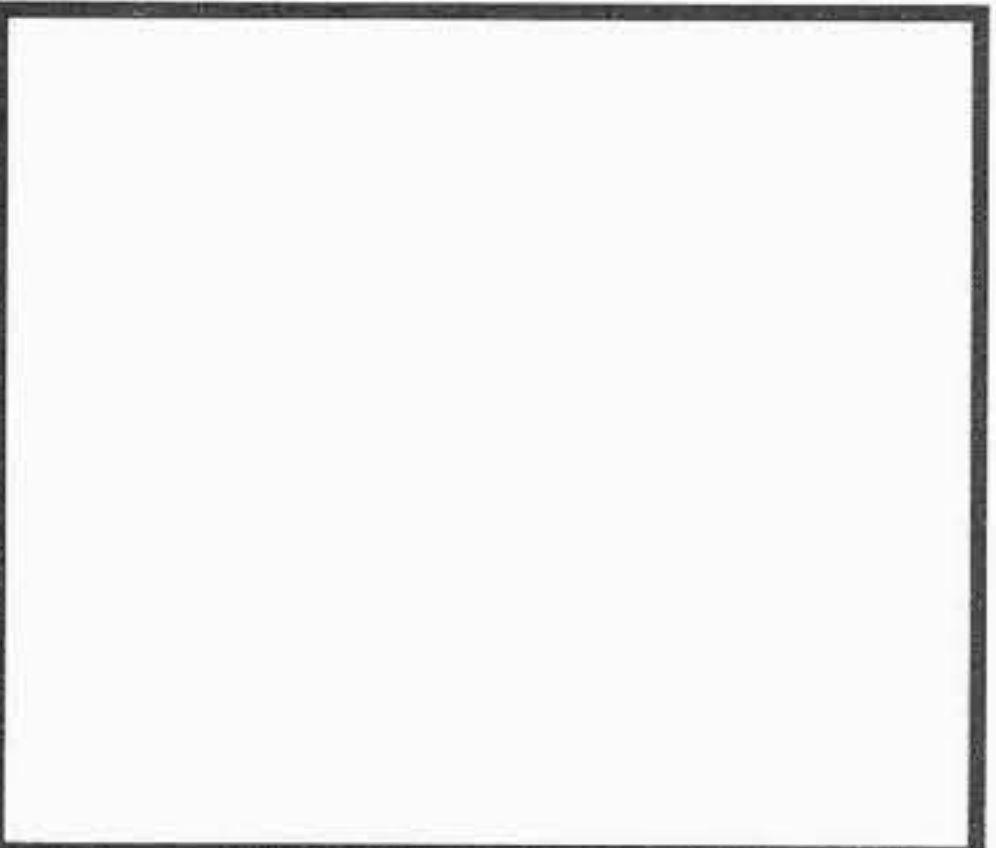

TIPO O MODELLO TYPE OU MODELE TYPE OR MODEL	MOTORE MOTEUR ENGINE	POMPA ACQUA POMPE A EAU WATER PUMP	KIT RIPARAZIONE NECESSAIRE DE REP. REPAIR KIT
<p>A 64 - A 66 -----&gt; 1986</p> <p>7910 - 8210 - 8530</p> <p>8630 - 8730 - 8830</p> <p>8700 - 9700</p> <p>TW 5 - TW 10 - TW 15 - TW 20 -----&gt; 1986</p> <p>TW 25 - TW 30 - TW 35</p>	<p>Ford 666 - 6 cyl.</p> <p>Ford 666 - 6 cyl.</p> <p>Ford 666 - 6 cyl.</p> <p>Ford 666 - 6 cyl.</p>	<p>--- D8NN8501MC CON BASAMENTO / WITH BACKPLATE 81872282</p>  <p>164.093 EAPN8A513G 81863921</p> <p>SENZA BASAMENTO / WITHOUT BACKPLATE</p>	<p>162.207 EAPN8591E 83961311</p>  <p>girante / impeller Ø 119 mm premistoppa monoblocco / monbloc seal</p>
<p>A 64 - A 66 1987 -----&gt;</p> <p>TW 5 - TW 10 - TW 15 - TW 20 1987 -----&gt;</p> <p>TW 25 - TW 30 - TW 35</p> <p>7810 ----&gt; 02 / 82 - 10 / 91</p>	<p>Ford 666 - 6 cyl.</p> <p>Ford 666 - 6 cyl.</p>	<p>--- E6NN8501AA CON BASAMENTO / WITH BACKPLATE 81872290</p>  <p>164.185 EJPN8A513BA 81863835</p> <p>SENZA BASAMENTO / WITHOUT BACKPLATE</p>	<p>162.152 EJPN8591DA 81863991</p>  <p>girante / impeller Ø 119 mm premistoppa monoblocco / monbloc seal</p>
<p>5110 - 5610 ----&gt; 11 / 88 - 10 / 91</p> <p>6610 - 7610 - 7710</p> <p>6410 ----&gt; 02 / 82 - 10 / 91</p> <p>6810</p> <p><b>SENZA aria condizionata WITHOUT air conditioning</b></p> <p><b>CON ventilatore viscostatico WITH viscostatic fan</b></p>	<p>Ford 4 cyl.</p>	<p>164.175 E7NN8501EB CON BASAMENTO / WITH BACKPLATE 81872287</p>  <p>164.180 EJPN8A513EB 81863909</p> <p>SENZA BASAMENTO / WITHOUT BACKPLATE</p>	<p>162.153 EJPN8591EB 81863983</p>  <p>girante / impeller Ø 96 mm premistoppa monoblocco / monbloc seal Ø 38,1 mm</p>
<p>5110 - 5610 ----&gt; 11 / 88 - 10 / 91</p> <p>6610 - 7610 - 7710</p> <p>6410 ----&gt; 02 / 82 - 10 / 91</p> <p>6810</p> <p><b>CON aria condizionata WITH air conditioning</b></p> <p><b>CON ventilatore viscostatico WITH viscostatic fan</b></p>	<p>Ford 4 cyl.</p>	<p>164.096 E7NN8501FE CON BASAMENTO / WITH BACKPLATE 81872289</p>  <p>164.097 E7NN8A513CE 81863830</p> <p>SENZA BASAMENTO / WITHOUT BACKPLATE</p>	<p>162.154 EJPN8591FB 81864001</p>  <p>girante / impeller Ø 96 mm premistoppa monoblocco / monbloc seal Ø 38,1 mm</p>

I ricambi non sono originali ma adattabili . Ogni riferimento originale é assolutamente indicativo .  
Spare parts are not original but perfectly suitable . Every original part number has to be considered for reference purpose only .



SUITABLE

# NEW HOLLAND FORD

Tel:+44(0)1925 850082 Fax: +(0)44 1925 850083

www.spwaterpumps.co.uk

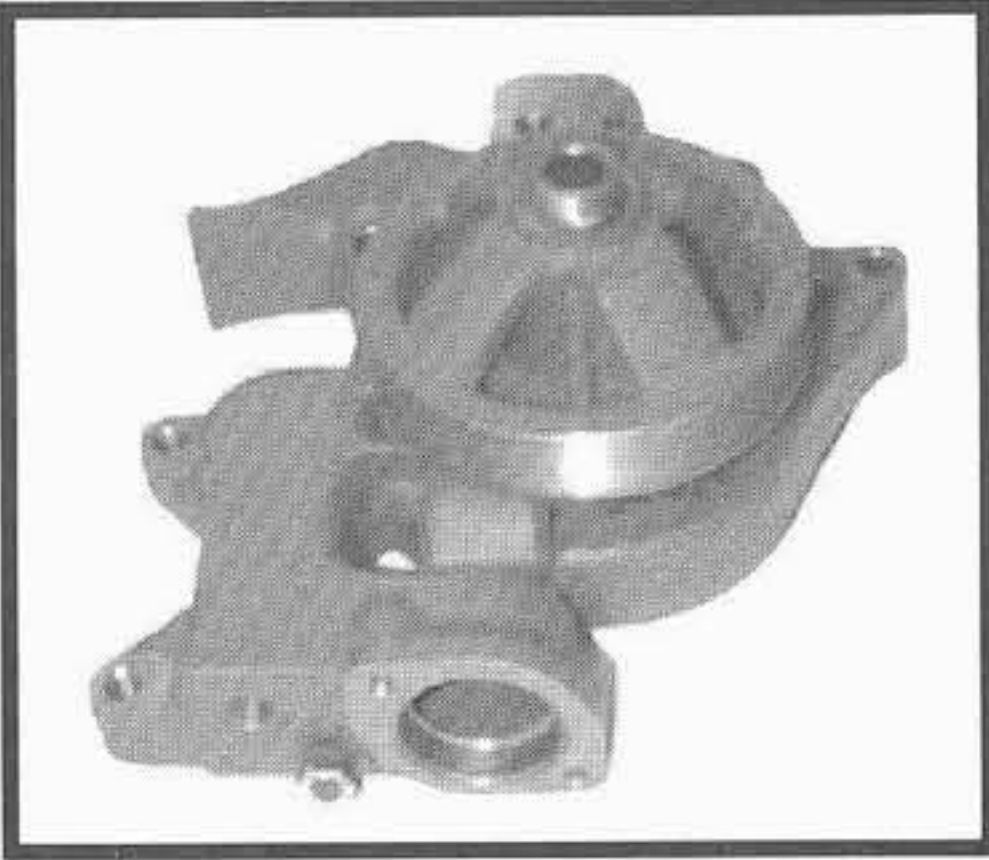
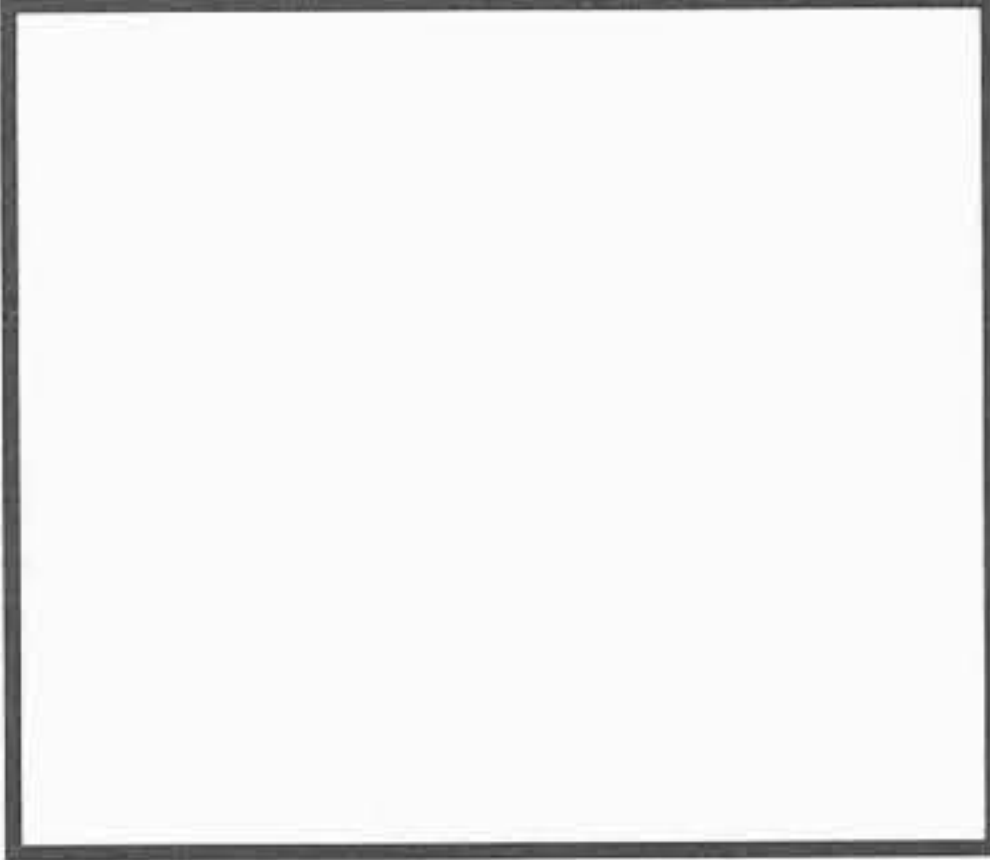
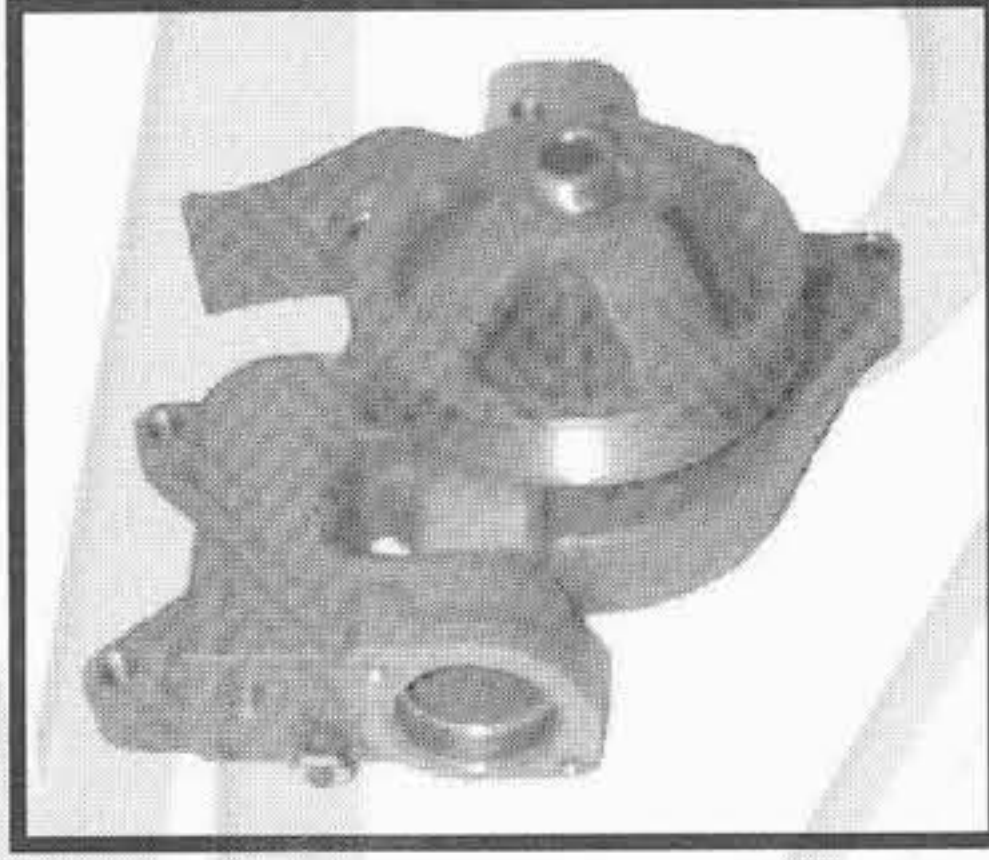
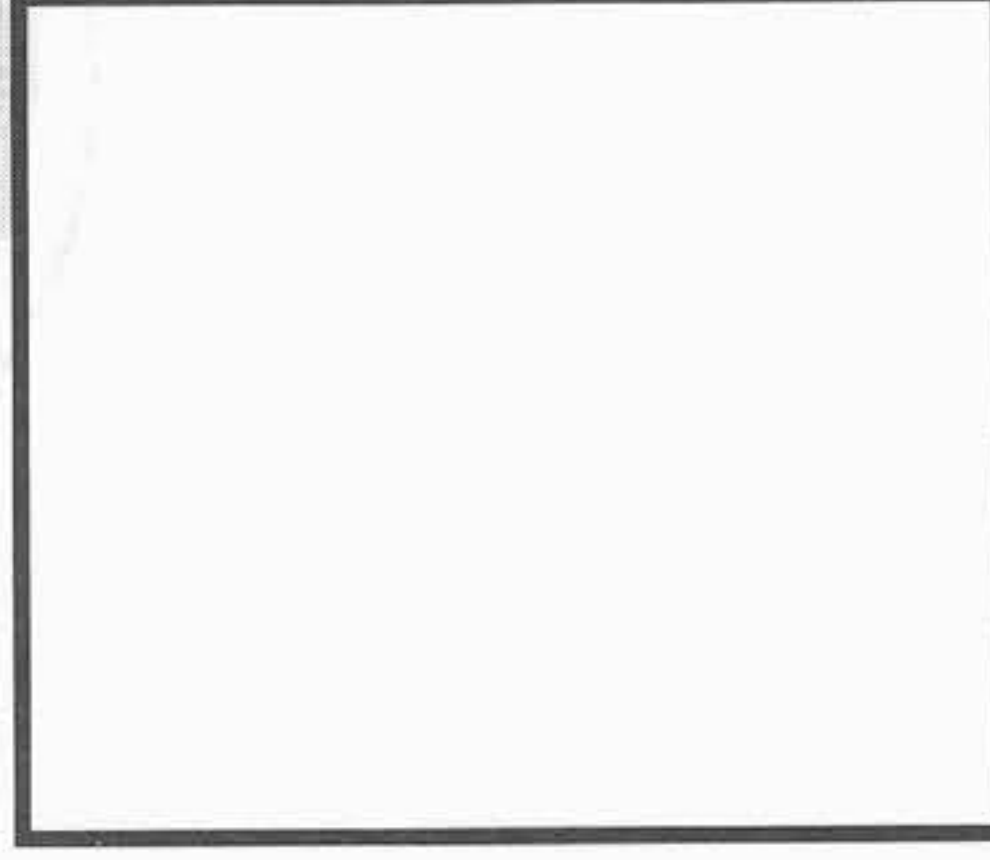
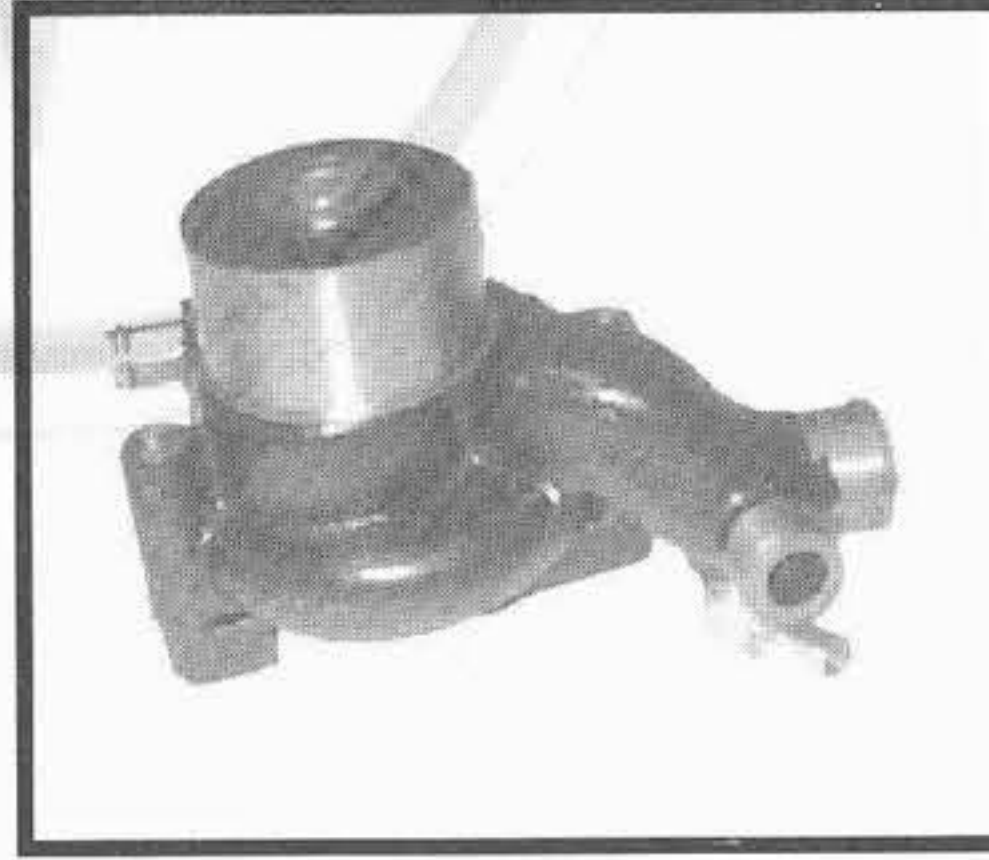
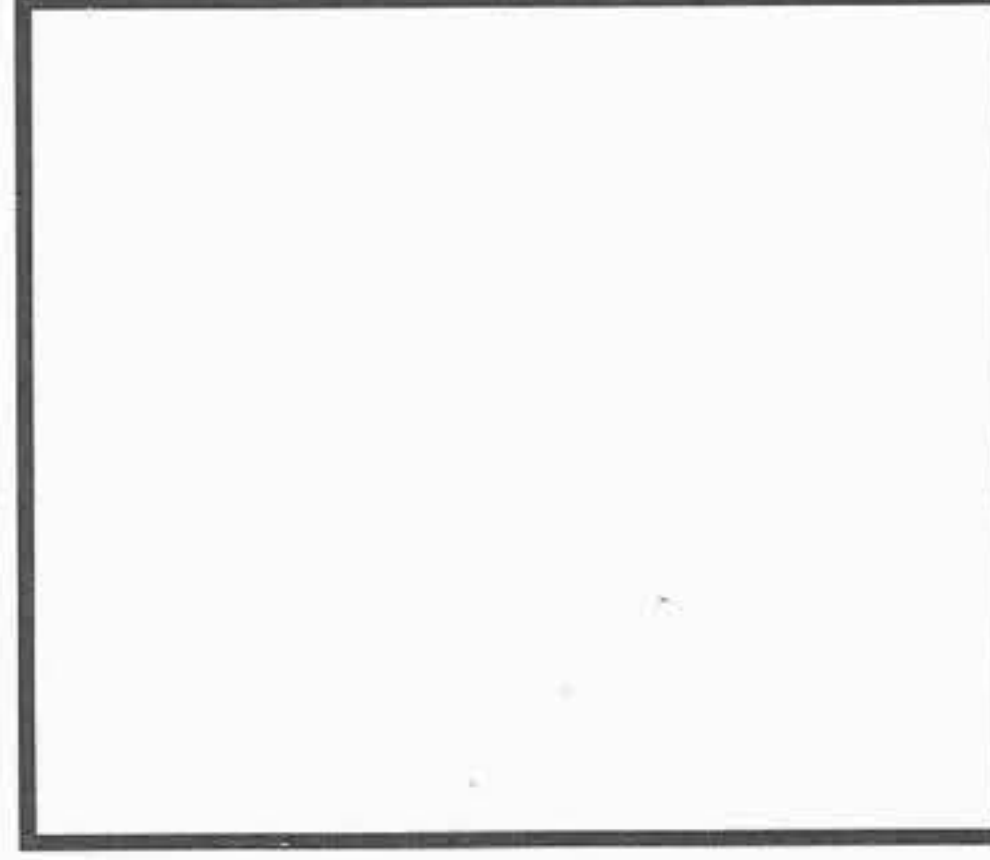

TIPO O MODELLO TYPE OU MODELE TYPE OR MODEL	MOTORE MOTEUR ENGINE	POMPA ACQUA POMPE A EAU WATER PUMP	KIT RIPARAZIONE NECESSAIRE DE REP. REPAIR KIT
5640 11 / 91 ----> 6640  6410 ----> 02 / 82 - 10 / 91 6810  <b>Serie TS</b> TS 90 - TS100 - TS110	Genesis 4 cyl. 5000 cc	<p style="text-align: center;"><b>164.170</b> FONN8501DC 81869617</p> 	<p style="text-align: center;"><b>162.156</b> FBPN8591A 81866488</p> 
7740 8240 11 / 91 ----> 8340  7840 ----> 02 / 82 - 10 / 91	Genesis 6 cyl. 7500 cc	<p style="text-align: center;"><b>164.165</b> FONN8501CC 81869616</p> 	<p style="text-align: center;"><b>162.157</b> FBPN8591B 81866491</p> 
8870 DT  <b>Serie G</b> G170 - G190 G210 - G240	6 cyl. Turbo 7500 cc	<p style="text-align: center;">- - 87800490</p> 	<p style="text-align: center;">- - 87790240</p> 
			

I ricambi non sono originali ma adattabili . Ogni riferimento originale é assolutamente indicativo .  
 Spare parts are not original but perfectly suitable . Every original part number has to be considered for reference purpose only .