

WATER PUMP CATALOGUE

TRUCK & BUS SECTION

ALL MAKES

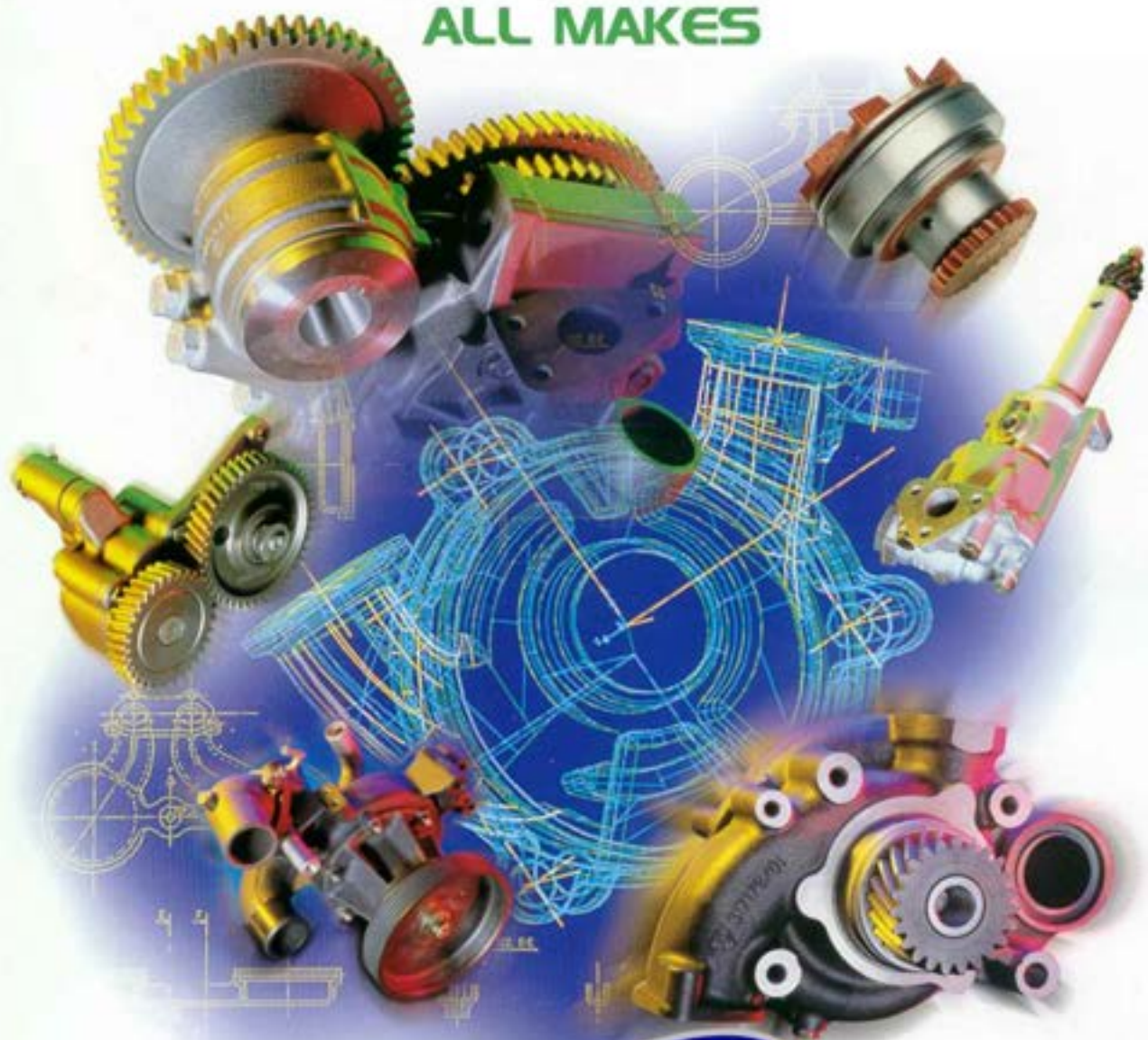

SP

WATER PUMPS

WEB EDITION

S.P. WATER PUMPS LTD

18 Tatton Court, Kingsland Grange, Woolston,
Warrington, Cheshire, ENGLAND, WAI 4RR

TEL: +44(0)1925 850082 FAX: +44(0)1925 850083

Email:sales@spwaterpumps.co.uk Web Site:www.spwaterpumps.co.uk



SECTION 33

APPLICATION

MERCEDES

BENZ

**WATER PUMPS WASSERPUMPEN
POMPE A EAU BOMBA DE AGUA
POMPA ACQUA**

S.P. WATER PUMPS LTD
18 Tatton Court, Kingsland Grange, Woolston,
Warrington, Cheshire. ENGLAND. WAI 4RR
TEL: +44(0) 1925 850082 Fax: +44(0) 1925 850083
Email:sales@spwaterpumps.co.uk Web Site:www.spwaterpumps.co.uk

TAVOLE DI CONVERSIONE
TABLE DE CONVERSION
CONVERSION TABLE

MERCEDES BENZ



NUMERO ORIGINALE NUMERO ORIGINAL ORIGINAL NUMBER	NUMERO SOSTITUTIVO REPLACE PAR NUMERO REPLACED BY NUMBER	RIFERIMENTO OMP REFERENCE OMP OMP REFERENCE
000.201.00.63		241.805
000.201.01.97	VEDI 241.805	241.853
000.201.04.63	VEDI 241.805	244.004
000.201.27.19		241.784
000.201.32.19	000.201.37.19	
000.201.37.19	000.201.61.19	
000.201.57.19	000.201.67.19	
000.201.61.19	000.201.66.19	
000.201.65.19	000.201.68.19	
000.201.66.19	000.201.72.19	
000.201.67.19	000.201.72.19	
000.201.68.19	000.201.69.19	
000.201.69.19	000.201.71.19	
000.201.71.19	000.201.73.19	
000.201.72.19		241.815
000.201.73.19	000.201.80.19	
000.201.80.19		241.857
000.997.19.88		241.774
000.997.75.47		241.770
000.997.77.47		241.769
001.981.96.01		241.810
002.997.84.46	=005.997.01.47	241.812
003.997.51.46	=005.997.00.47	241.811
003.997.57.48		241.798
005.997.00.47	=003.997.51.46	241.811
005.997.01.47	=002.997.84.46	241.812
005.997.11.45		241.813
011.997.70.48		241.912
304.357.01.21		241.838
314.200.00.60	314.200.40.01	
314.200.01.04	314.200.06.04	
314.200.01.60		242.222
314.200.03.04	314.200.04.04	
314.200.04.04	314.200.07.04	
314.200.05.04	314.200.08.04	
314.200.06.01	314.200.08.01	
314.200.06.04	314.200.09.04	
314.200.07.04	314.200.10.04	
314.200.08.01	314.200.19.01	
314.200.08.04	314.200.11.04	
314.200.09.04		242.223
314.200.10.04		242.224
314.200.11.04		242.225
314.200.19.01	314.200.21.01	
314.200.21.01	314.200.24.01	
314.200.24.01	314.200.29.01	
314.200.29.01	314.200.37.01	

NUMERO ORIGINALE NUMERO ORIGINAL ORIGINAL NUMBER	NUMERO SOSTITUTIVO REPLACE PAR NUMERO REPLACED BY NUMBER	RIFERIMENTO OMP REFERENCE OMP OMP REFERENCE
314.200.35.01	314.200.41.01	
314.200.37.01	314.200.39.01	
314.200.39.01	314.200.42.01	
314.200.40.01		242.202
314.200.41.01	314.200.47.01	
314.200.42.01		241.900
314.200.47.01		241.930
314.201.00.07	364.200.06.04	241.934
314.201.05.01		241.931
314.586.00.20	314.200.00.60	
314.586.01.20	314.200.01.04	
315.201.01.02		241.762
315.201.01.51		241.766
315.201.01.80		241.775
315.201.02.05		241.764
315.201.03.03		241.782
315.202.00.08		241.763
321.200.04.01	352.200.23.01	
322.200.02.03	352.200.15.01	
322.200.08.01	352.200.23.01	
326.200.02.01	326.200.09.01	
326.200.07.01	346.200.04.01	
326.200.09.01	346.200.04.01	
326.200.13.01	346.200.04.01	
327.200.00.60	360.200.44.01	
327.201.01.05		241.737
327.201.07.80		241.899
327.203.01.80		241.742
327.203.03.80	352.203.04.80	
329.200.00.20		241.915
345.200.71.01		241.955
346.200.00.01	355.200.00.01	
346.200.00.04		242.074
346.200.01.04		242.195
346.200.02.01	355.200.00.01	
346.200.04.01	346.200.11.01	
346.200.10.01		241.845
346.200.11.01		241.780
346.200.12.01		242.064
346.201.00.07		241.785
346.201.02.01		241.781
346.201.05.07		241.863
346.586.00.20	346.200.12.01	
346.586.02.20	346.200.00.04	
346.586.03.20	346.200.01.04	
352.200.02.60	352.200.05.60	
352.200.04.60	353.200.30.01	

OGNI RIFERIMENTO ORIGINALE E' ASSOLUTAMENTE INDICATIVO. CHAQUE REFERENCE ORIGINAL EST ABSOLUMENT INDICATIVE. EVERY ORIGINAL PART NUMBER HAS TO BE CONSIDERED FOR REFERENCE PURPOSE ONLY.

TAVOLE DI CONVERSIONE
TABLE DE CONVERSION
CONVERSION TABLE

MERCEDES BENZ



NUMERO ORIGINALE NUMERO ORIGINAL ORIGINAL NUMBER	NUMERO SOSTITUTIVO REPLACE PAR NUMERO REPLACED BY NUMBER	RIFERIMENTO OMP REFERENCE OMP OMP REFERENCE
352.200.05.60	353.200.31.01	
352.200.06.04	352.200.08.04	
352.200.06.60	353.200.25.01	
352.200.07.04	352.200.08.04	
352.200.08.04	352.200.09.04	
352.200.08.60	353.200.24.01	
352.200.09.04	352.200.10.04	
352.200.09.60		242.227
352.200.10.04	352.200.19.04	
352.200.10.60	353.200.26.01	
352.200.13.04	352.200.28.04	
352.200.14.04	352.200.29.04	
352.200.15.01	352.200.20.01	
352.200.15.04	352.200.30.04	
352.200.16.04	352.200.31.04	
352.200.17.04	352.200.32.04	
352.200.19.04	352.200.33.04	
352.200.20.01	352.200.23.01	
352.200.23.01	352.200.93.01	
352.200.23.04	352.200.34.04	
352.200.24.04	352.200.35.04	
352.200.25.04	352.200.36.04	
352.200.28.04	352.200.38.04	
352.200.29.04	352.200.39.04	
352.200.30.04	352.200.40.04	
352.200.31.04	352.200.41.04	
352.200.32.04	352.200.42.04	
352.200.33.04	352.200.43.04	
352.200.34.01	352.200.54.01	
352.200.34.04	352.200.44.04	
352.200.35.04	352.200.45.04	
352.200.36.04	352.200.46.04	
352.200.38.01	352.200.94.01	
352.200.38.04		242.191
352.200.39.01	352.200.94.01	
352.200.39.04		242.205
352.200.40.04		242.164
352.200.41.04		242.215
352.200.42.04		242.146
352.200.43.04		242.228
352.200.44.04		242.229
352.200.45.04		242.230
352.200.46.04		
352.200.49.01	352.200.84.01	
352.200.54.01	352.200.95.01	
352.200.72.01	352.200.85.01	
352.200.74.01	352.200.84.01	

NUMERO ORIGINALE NUMERO ORIGINAL ORIGINAL NUMBER	NUMERO SOSTITUTIVO REPLACE PAR NUMERO REPLACED BY NUMBER	RIFERIMENTO OMP REFERENCE OMP OMP REFERENCE
352.200.75.01	352.200.85.01	
352.200.81.01	352.200.95.01	
352.200.84.01	353.200.04.01	
352.200.85.01	352.200.92.01	
352.200.86.01	353.200.19.01	
352.200.87.01	353.200.15.01	
352.200.89.01	352.200.96.01	
352.200.92.01	352.200.97.01	
352.200.93.01	353.200.40.01	
352.200.94.01	353.200.03.01	
352.200.95.01	352.200.96.01	
352.200.96.01	353.200.16.01	
352.200.97.01	353.200.17.01	
352.201.00.12		241.797
352.201.00.39		241.792
352.201.00.58	352.201.02.58	
352.201.01.05		241.802
352.201.01.07		241.793
352.201.02.01		241.777
352.201.02.58	352.201.05.58	
352.201.03.01		241.747
352.201.04.80		241.778
352.201.05.07	366.200.02.04	241.847
352.201.05.58		241.848
352.201.05.80		241.789
352.201.06.01		241.744
352.201.06.05		241.746
352.201.06.80		241.897
352.201.08.03	352.201.09.03	
352.201.08.80		241.854
352.201.09.03		241.779
352.201.10.01		241.843
352.201.10.80		241.898
352.201.11.80	352.201.12.80	
352.201.12.80		241.851
352.201.13.03	352.201.18.03	
352.201.14.03		
352.201.15.03		241.748
352.201.16.03		241.844
352.201.17.01		241.756
352.201.17.03		241.757
352.201.18.03		241.937
352.201.19.01		241.936
352.201.19.03		241.942
352.201.20.03		241.939
352.201.21.01		241.941
352.201.22.01		241.938

OGNI RIFERIMENTO ORIGINALE E' ASSOLUTAMENTE INDICATIVO. CHAQUE REFERENCE ORIGINAL EST ABSOLUMENT INDICATIVE. EVERY ORIGINAL PART NUMBER HAS TO BE CONSIDERED FOR REFERENCE PURPOSE ONLY.

TAVOLE DI CONVERSIONE
TABLE DE CONVERSION
CONVERSION TABLE

MERCEDES BENZ



NUMERO ORIGINALE NUMERO ORIGINAL ORIGINAL NUMBER	NUMERO SOSTITUTIVO REPLACE PAR NUMERO REPLACED BY NUMBER	RIFERIMENTO OMP REFERENCE OMP OMP REFERENCE
352.203.04.80		241.796
352.203.07.80	352.203.16.80	
352.203.16.80		241.909
352.586.00.20	353.200.42.01	
352.586.02.20	352.200.04.60	
352.586.03.20	352.200.02.60	
352.586.04.20	352.586.05.20	
352.586.05.20	352.200.02.60	
352.586.06.20	352.200.13.04	
352.586.07.20	352.200.14.04	
352.586.08.20	353.200.00.04	
352.586.10.20	352.200.06.60	
352.586.11.20	352.200.15.04	
352.586.12.20	352.200.16.04	
352.586.15.20	352.200.17.04	
353.200.02.01	353.200.05.01	
353.200.03.01	353.200.21.01	
353.200.04.01	353.200.36.01	
353.200.05.01	353.200.20.01	
353.200.15.01	314.200.37.01	
353.200.16.01	353.200.17.01	
353.200.17.01	353.200.38.01	
353.200.19.01	353.200.39.01	
353.200.20.01		241.990
353.200.21.01	353.200.37.01	
353.200.24.01		242.226
353.200.25.01		242.188
353.200.30.01		242.204
353.200.31.01		242.196
353.200.36.01	353.200.37.01	
353.200.37.01		241.935
353.200.38.01	353.200.56.01	
353.200.39.01		241.945
353.200.40.01		241.790
353.200.42.01		
353.200.56.01		241.940
355.200.00.01		241.760
355.200.00.60		242.067
355.200.01.01	355.200.08.01	
355.200.01.60	355.200.13.01	
355.200.02.01	345.200.71.01	
355.200.02.60	355.200.14.01	
355.200.04.04	355.200.09.04	
355.200.05.01	355.200.09.01	
355.200.06.01	355.200.08.01	
355.200.05.04		242.075
355.200.07.04	355.200.10.04	

NUMERO ORIGINALE NUMERO ORIGINAL ORIGINAL NUMBER	NUMERO SOSTITUTIVO REPLACE PAR NUMERO REPLACED BY NUMBER	RIFERIMENTO OMP REFERENCE OMP OMP REFERENCE
355.200.08.01	355.200.09.01	241.800
355.200.08.04	355.200.12.04	
355.200.09.01	355.200.11.01	241.890
355.200.09.04	355.200.13.04	
355.200.10.04	355.200.14.04	
355.200.11.01	355.200.15.01	
355.200.12.04		242.212
355.200.13.01		242.065
355.200.13.04		242.076
355.200.14.01		242.211
355.200.14.04		242.161
355.200.15.01		241.905
355.201.00.01		241.761
355.201.00.07		241.765
355.201.00.39		241.907
355.201.00.72		241.808
255.201.00.80		241.864
355.201.01.01		241.801
355.201.01.07		241.892
355.201.02.07		241.903
355.201.03.01		241.891
355.201.04.01		241.904
355.586.00.20	355.200.00.60	
355.586.01.20	355.200.01.60	
355.586.02.20	355.200.04.04	
355.586.03.20	355.200.05.04	
355.586.06.20	355.200.07.04	
356.201.00.07		241.803
356.201.00.39		241.807
356.201.01.80		241.864
360.200.00.60	360.200.43.01	
360.200.01.01	360.200.16.01	
360.200.01.04	360.200.05.04	
360.200.01.60	360.200.41.01	
360.200.02.60	360.200.42.01	
360.200.03.01	360.200.09.01	
360.200.03.04	360.200.06.04	
360.200.04.04	360.200.05.04	
360.200.05.04	360.200.07.04	
360.200.06.04		242.071
360.200.07.04		242.058
360.200.09.01	360.200.37.01	
360.200.11.01	360.200.17.01	
360.200.16.01	360.200.32.01	
360.200.17.01	360.200.38.01	
360.200.23.01	360.200.38.01	
360.200.32.01	360.200.38.01	

OGNI RIFERIMENTO ORIGINALE E' ASSOLUTAMENTE INDICATIVO. CHAQUE REFERENCE ORIGINAL EST ABSOLUMENT INDICATIVE. EVERY ORIGINAL PART NUMBER HAS TO BE CONSIDERED FOR REFERENCE PURPOSE ONLY.

TAVOLE DI CONVERSIONE
 TABLE DE CONVERSION
 CONVERSION TABLE

MERCEDES BENZ



NUMERO ORIGINALE NUMERO ORIGINAL ORIGINAL NUMBER	NUMERO SOSTITUTIVO REPLACE PAR NUMERO REPLACED BY NUMBER	RIFERIMENTO OMP REFERENCE OMP OMP REFERENCE
360.200.37.01	360.200.45.01	
360.200.38.01	360.200.46.01	
360.200.41.01	360.200.42.01	
360.200.42.01		242.057
360.200.44.01		
360.200.45.01		241.735
360.200.46.01		241.740
360.201.00.05		241.738
360.201.01.07		241.739
360.201.01.80		241.743
360.201.04.01		241.741
360.201.05.01		241.736
360.586.01.20	360.586.02.20	
360.586.02.20	360.200.01.60	
360.586.03.20	360.200.01.04	
360.586.05.20	360.200.03.04	
360.586.06.20	360.200.04.04	
364.200.00.60	364.200.18.01	
364.200.01.01	364.200.09.01	
364.200.02.04	364.200.03.04	
364.200.03.04	364.200.05.04	
364.200.05.04	364.200.08.04	
364.200.06.04		241.948
364.200.08.04		242.248
364.200.09.01	364.200.20.01	
364.200.18.01		242.231
364.200.20.01		241.965
364.201.00.01		241.921
366.200.00.04	366.200.03.04	
366.200.00.60	366.200.40.01	
366.200.02.04		241.949
366.200.03.04	366.200.06.04	
366.200.04.01	366.200.09.01	
366.200.04.04	366.200.07.04	
366.200.05.01	366.200.15.01	
366.200.05.04	366.200.09.04	
366.200.06.04	366.200.08.04	
366.200.07.04	366.200.09.04	
366.200.08.04		242.249
366.200.09.01	366.200.59.01	
366.200.09.04		
366.200.15.01	366.200.60.01	
366.200.19.01	366.200.61.01	
366.200.22.01	366.200.15.01	
366.200.25.01	366.200.62.01	
366.200.26.01	366.200.41.01	
366.200.40.01		

NUMERO ORIGINALE NUMERO ORIGINAL ORIGINAL NUMBER	NUMERO SOSTITUTIVO REPLACE PAR NUMERO REPLACED BY NUMBER	RIFERIMENTO OMP REFERENCE OMP OMP REFERENCE
366.200.59.01		241.975
366.200.60.01		241.985
366.200.61.01		
366.200.62.01		
366.201.02.01		241.911
366.202.00.80		241.913
390.200.00.01		
403.200.02.60	403.200.69.01	
403.200.04.02	403.200.07.02	
403.200.06.01	403.200.36.01	
403.200.07.02	403.200.09.02	
403.200.09.02	403.200.10.02	
403.200.10.01	403.200.36.01	
403.200.10.02	403.200.15.02	
403.200.15.02		241.837
403.200.17.02	403.200.18.02	
403.200.18.02	403.200.19.02	
403.200.19.02		241.906
403.200.22.01	403.200.39.01	
403.200.24.01	403.200.49.01	
403.200.25.01	403.200.49.01	
403.200.27.01	403.200.35.01	
403.200.32.01	403.200.35.01	
403.200.34.01	403.200.35.01	
403.200.35.01	403.200.49.01	
403.200.36.01	403.200.39.01	
403.200.37.01	403.200.52.01	
403.200.39.01	403.200.50.01	
403.200.44.01	403.200.51.01	
403.200.46.01	403.200.58.01	
403.200.47.01	403.200.53.01	
403.200.49.01	403.200.70.01	
403.200.50.01		241.830
403.200.51.01	403.200.71.01	
403.200.52.01	403.200.72.01	
403.200.53.01	403.200.73.01	
403.200.58.01	403.200.74.01	
403.200.59.01	403.200.53.01	
403.200.64.01	403.200.75.01	
403.200.69.01	422.200.09.01	
403.200.70.01		241.825
403.200.71.01		241.835
403.200.72.01		241.840
403.200.73.01		241.895
403.200.74.01		241.950
403.200.75.01		
403.200.76.01		

OGNI RIFERIMENTO ORIGINALE E' ASSOLUTAMENTE INDICATIVO. CHAQUE REFERENCE ORIGINAL EST ABSOLUMENT INDICATIVE. EVERY ORIGINAL PART NUMBER HAS TO BE CONSIDERED FOR REFERENCE PURPOSE ONLY.

SUITABLE

MERCEDES BENZ AUTOCARRI - CAMIONS - TRUCKS

Tel:+44(0)1925 850082 Fax: +(0)44 1925 850083

www.spwaterpumps.co.uk

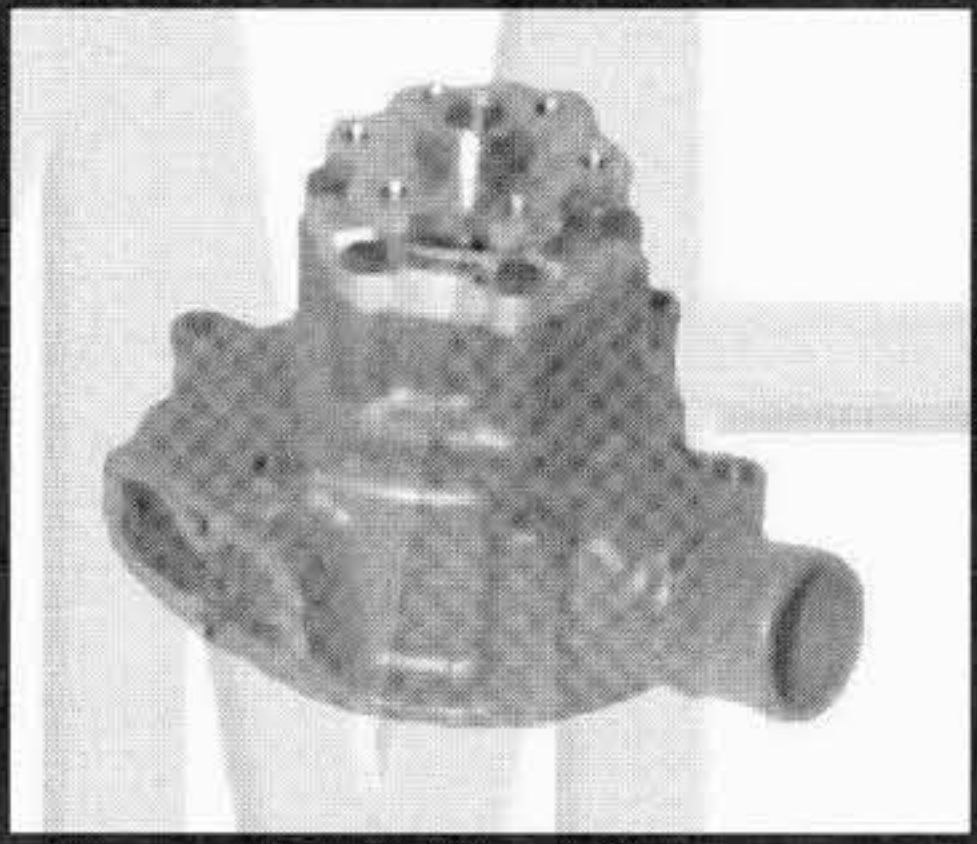
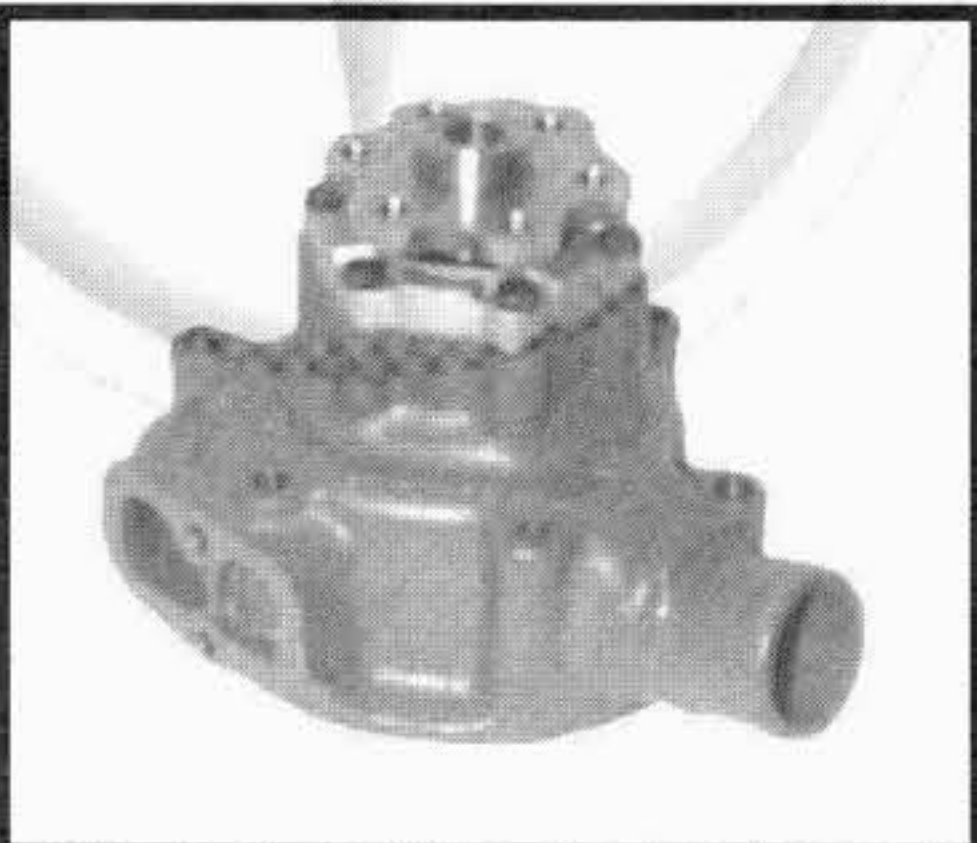
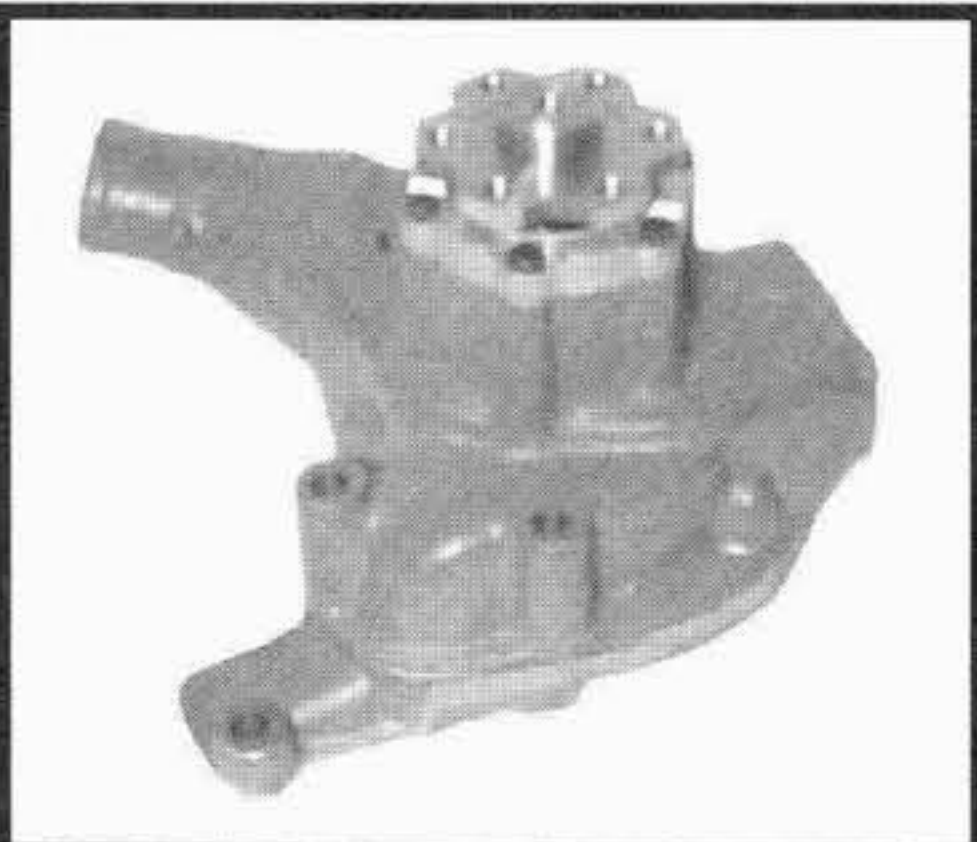

TIPO O MODELLO TYPE OU MODELE TYPE OR MODEL	MOTORE MOTEUR ENGINE	POMPA ACQUA POMPE A EAU WATER PUMP	KIT RIPARAZIONE NECESSAIRE DE REP. REPAIR KIT
408 508 - LF 508 608 709 808 809	OM 314 --> mot. 430644	<p>--- 314.200.24.01</p> <div style="border: 1px solid black; padding: 10px; text-align: center;"> <p>SOST. DA : / REPLACE BY :</p> <p>241.900</p> <p>314.200.42.01</p> </div> <p>albero con foro filettato / shaft with threaded bore girante / impeller Ø 87 mm</p>	<p>242.223 314.200.09.04</p> <div style="border: 1px solid black; height: 100px; width: 100%;"></div>
408 508 - LF 508 608 709 808 809	OM 314 mot. 430345 --> --> mot. 456936	<p>241.900 314.200.42.01</p> <div style="border: 1px solid black; padding: 10px; text-align: center;">  </div> <p>albero con foro filettato / shaft with threaded bore girante / impeller Ø 95 mm</p>	<p>242.224 314.200.10.04</p> <div style="border: 1px solid black; height: 100px; width: 100%;"></div>
408 508 - LF 508 608 709 808 809	OM 314 mot. 459637 -->	<p>241.930 314.200.47.01</p> <div style="border: 1px solid black; padding: 10px; text-align: center;">  </div>	<p>242.225 314.200.11.04</p> <div style="border: 1px solid black; height: 100px; width: 100%;"></div>
<p>L / LA / LP / LAP 311 L / LA / LP / LAP 312 L / LA / LP / LAP 328 710 L / LA / LP / LAP 911 - L / LA 911B</p> <p>L / LA 322 L / LA / LP / LAP 327 L / LA 1113 - LA 1313 - 1317 LA 1513 - 1517 - 1813</p> <p>LF / LAF 323 328 - LF / LAF 710 L / LA 911</p>	<p>OM 352 --> mot. 018151</p> <p>OM 352 --> mot. 034435</p> <p>OM 352 --> mot. 011957</p>	<p>241.790 353.200.40.01</p> <div style="border: 1px solid black; padding: 10px; text-align: center;">  </div> <p>albero senza foro filettato / shaft without threaded bore girante / impeller Ø 87 mm</p>	<p>242.191 352.200.38.04</p> <div style="border: 1px solid black; height: 100px; width: 100%;"></div>

I ricambi non sono originali ma adattabili . Ogni riferimento originale é assolutamente indicativo .
Spare parts are not original but perfectly suitable . Every original part number has to be considered for reference purpose only .

SUITABLE

MERCEDES BENZ

AUTOCARRI - CAMIONS - TRUCKS

Tel:+44(0)1925 850082 Fax: +(0)44 1925 850083

www.spwaterpumps.co.uk

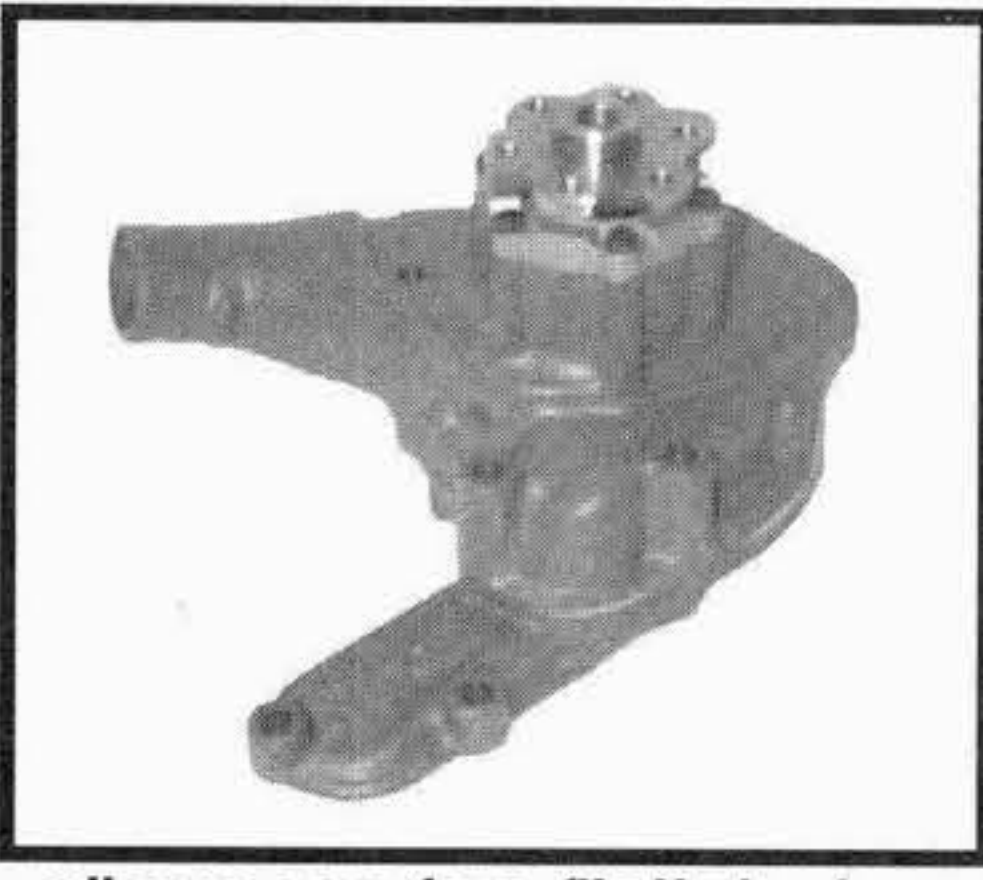

TIPO O MODELLO TYPE OU MODELE TYPE OR MODEL	MOTORE MOTEUR ENGINE	POMPA ACQUA POMPE A EAU WATER PUMP	KIT RIPARAZIONE NECESSAIRE DE REP. REPAIR KIT
LF / LAF 323 328 LF / LAF 710 L / LA 911	OM 352 mot. 011958 -->	--- 352.200.94.01 <div style="border: 1px solid black; padding: 5px; text-align: center;"> SOST. DA : / </div> <div style="border: 1px solid black; padding: 5px; text-align: center;"> REPLACE BY : 241.935 353.200.37.01 </div> albero senza foro filettato / shaft without threaded bore girante / impeller Ø 87 mm	242.191 352.200.38.04 <div style="border: 1px solid black; width: 100%; height: 100%;"></div>
L / LA / LP / LAP 311 L / LA / LP / LAP 312 L / LA / LP / LAP 328 710 L / LA / LP / LAP 911 - L / LA 911B L / LA 322 L / LA / LP / LAP 327 L / LA 1113 - LA 1313 - 1317 LA 1513 - 1517 - 1813 LF / LAF 323 328 - LF / LAF 710 L / LA 911	OM 352 OM 352 OM 352	--- 353.200.03.01 <div style="border: 1px solid black; padding: 5px; text-align: center;"> SOST. DA : / </div> <div style="border: 1px solid black; padding: 5px; text-align: center;"> REPLACE BY : 241.935 353.200.37.01 </div> albero senza foro filettato / shaft without threaded bore girante / impeller Ø 95 mm	242.228 352.200.43.04 <div style="border: 1px solid black; width: 100%; height: 100%;"></div>
L / LA / LP / LAP 311 L / LA / LP / LAP 312 L / LA / LP / LAP 328 710 L / LA / LP / LAP 911 - L / LA 911B L / LA 322 L / LA / LP / LAP 327 L / LA 1113 - LA 1313 - 1317 LA 1513 - 1517 - 1813	OM 352 mot. 018152 --> OM 352 mot. 034436 -->	--- 353.200.36.01 <div style="border: 1px solid black; padding: 5px; text-align: center;"> SOST. DA : / </div> <div style="border: 1px solid black; padding: 5px; text-align: center;"> REPLACE BY : 241.935 353.200.37.01 </div> albero con foro filettato / shaft with threaded bore girante / impeller Ø 95 mm	242.229 352.200.44.04 <div style="border: 1px solid black; width: 100%; height: 100%;"></div>
L / LA / LP / LAP 311 L / LA / LP / LAP 312 L / LA 322 - LF / LAF 323 L / LA / LP / LAP 327 L / LA / LP / LAP 328 - 328 710 - LF / LAF 710 L / LA / LP / LAP 911 - L / LA 911B L / LA 1113 - LA 1313 1317 - LA 1513 1517 - 1813	OM 352	241.935 353.200.37.01 <div style="border: 1px solid black; padding: 5px; text-align: center;">  </div> albero con foro filettato / shaft with threaded bore girante / impeller Ø 95 mm	242.229 352.200.44.04 <div style="border: 1px solid black; width: 100%; height: 100%;"></div>

I ricambi non sono originali ma adattabili . Ogni riferimento originale é assolutamente indicativo .
 Spare parts are not original but perfectly suitable . Every original part number has to be considered for reference purpose only .

SUITABLE

MERCEDES BENZ **AUTOCARRI - CAMIONS - TRUCKS**

Tel: +44(0)1925 850082 Fax: +(0)44 1925 850083

www.spwaterpumps.co.uk



TIPO O MODELLO TYPE OU MODELE TYPE OR MODEL	MOTORE MOTEUR ENGINE	POMPA ACQUA POMPE A EAU WATER PUMP	KIT RIPARAZIONE NECESSAIRE DE REP. REPAIR KIT
LP 811 LP 911 - LP 913 613 - 813 - 913 - 1013 LP / LPK 1113 1213 - LP 1213 - 1413 OF 1413 - 1613 1013 - LP / LPK 1113 1213 - LP 1213 LP 1313 1413 - OF 1413 1017 - 1217 1417 - 1617	OM 352 --> mot. 017729 OM 352 --> mot. 441885 OM 352 --> mot. 049763 OM 352 --> mot. 473680	--- 352.200.95.01 <div style="border: 1px solid black; padding: 10px; text-align: center;"> <p>SOST. DA : / REPLACE BY :</p> <p>241.940</p> <p>353.200.56.01</p> </div> albero senza foro filettato / shaft without threaded bore girante / impeller Ø 87 mm	242.205 352.200.39.04 <div style="border: 1px solid black; width: 100%; height: 100%;"></div>
810 - 811 - LP 811 LP 911 - LP 913 613 - 813 - 913 - 1013 LP / LPK 1113 - 1213 - LP 1213 1413 - OF 1413 - 1613 1013 - LP / LPK 1113 - 1213 LP 1213 - LP 1313 - 1413 - OF 1413 1413 - OF 1413 1017 - 1217 1417 - 1617 1513 LP	OM 352 mot. 017730 --> OM 352 mot. 441886 --> OM 352 mot. 049764 --> OM 352 mot. 473681 --> OM 352	--- 352.200.96.01 <div style="border: 1px solid black; padding: 10px; text-align: center;"> <p>SOST. DA : / REPLACE BY :</p> <p>241.940</p> <p>353.200.56.01</p> </div> albero senza foro filettato / shaft without threaded bore girante / impeller Ø 95 mm	242.164 352.200.41.04 <div style="border: 1px solid black; width: 100%; height: 100%;"></div>
LP 810 LP 813 911 B	OM 352.985	--- 352.200.97.01 <div style="border: 1px solid black; padding: 10px; text-align: center;"> <p>SOST. DA : / REPLACE BY :</p> <p>241.940</p> <p>353.200.56.01</p> </div> albero con foro filettato / shaft with threaded bore girante / impeller Ø 87 mm	242.164 352.200.41.04 <div style="border: 1px solid black; width: 100%; height: 100%;"></div>
810 - 811 - LP 811 LP 911 - LP 913 613 - 813 - 913 - 1013 LP / LPK 1113 - 1213 - LP 1213 1413 - OF 1413 - 1613 1013 - LP / LPK 1113 - 1213 LP 1213 - LP 1313 - 1413 - OF 1413 1413 - OF 1413 1017 - 1217 1417 - 1617 1513 LP	OM 352 OM 352 OM 352 OM 352 OM 352	--- 353.200.16.01 <div style="border: 1px solid black; padding: 10px; text-align: center;"> <p>SOST. DA : / REPLACE BY :</p> <p>241.940</p> <p>353.200.56.01</p> </div> albero senza foro filettato / shaft without threaded bore girante / impeller Ø 95 mm	242.164 352.200.40.04 <div style="border: 1px solid black; width: 100%; height: 100%;"></div>

I ricambi non sono originali ma adattabili . Ogni riferimento originale é assolutamente indicativo .
 Spare parts are not original but perfectly suitable . Every original part number has to be considered for reference purpose only .



SUITABLE

MERCEDES BENZ AUTOCARRI - CAMIONS - TRUCKS

Tel:+44(0)1925 850082 Fax: +(0)44 1925 850083

www.spwaterpumps.co.uk

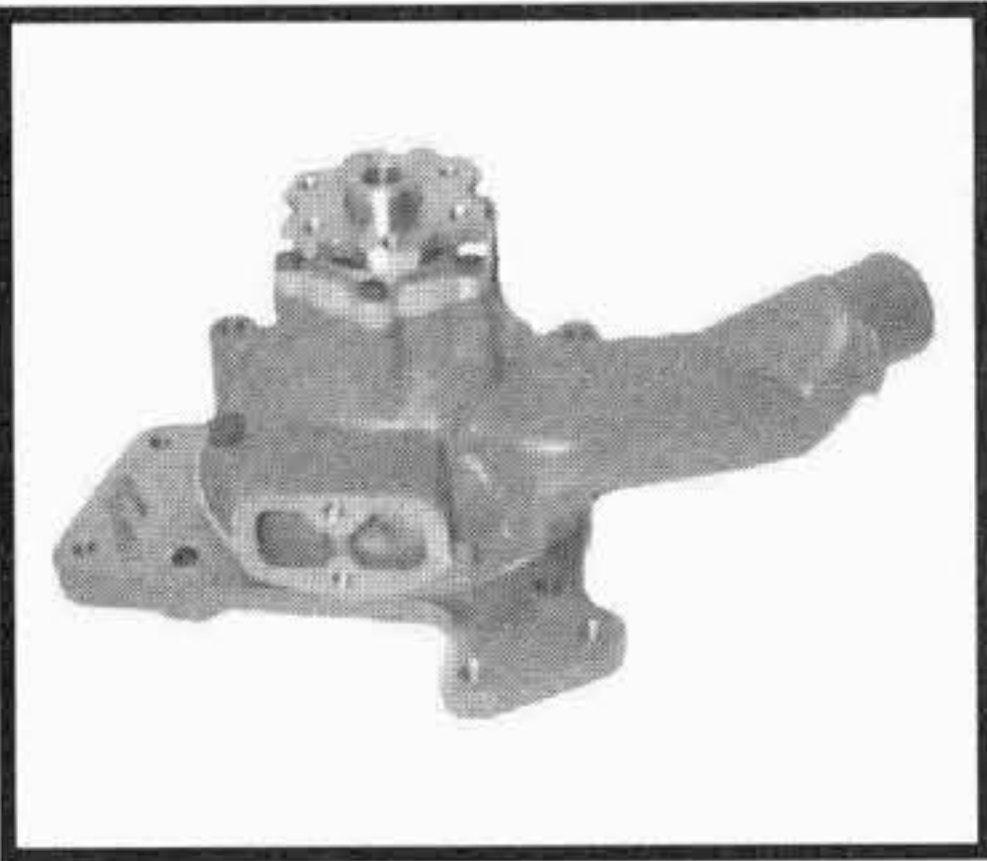
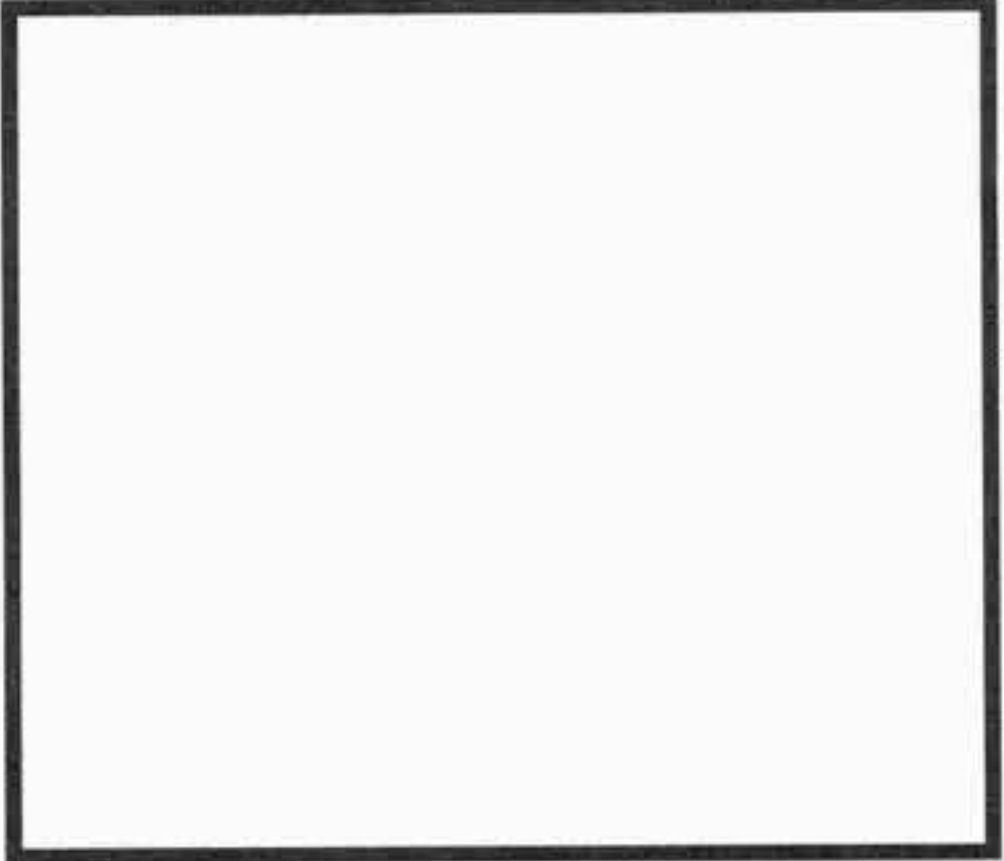

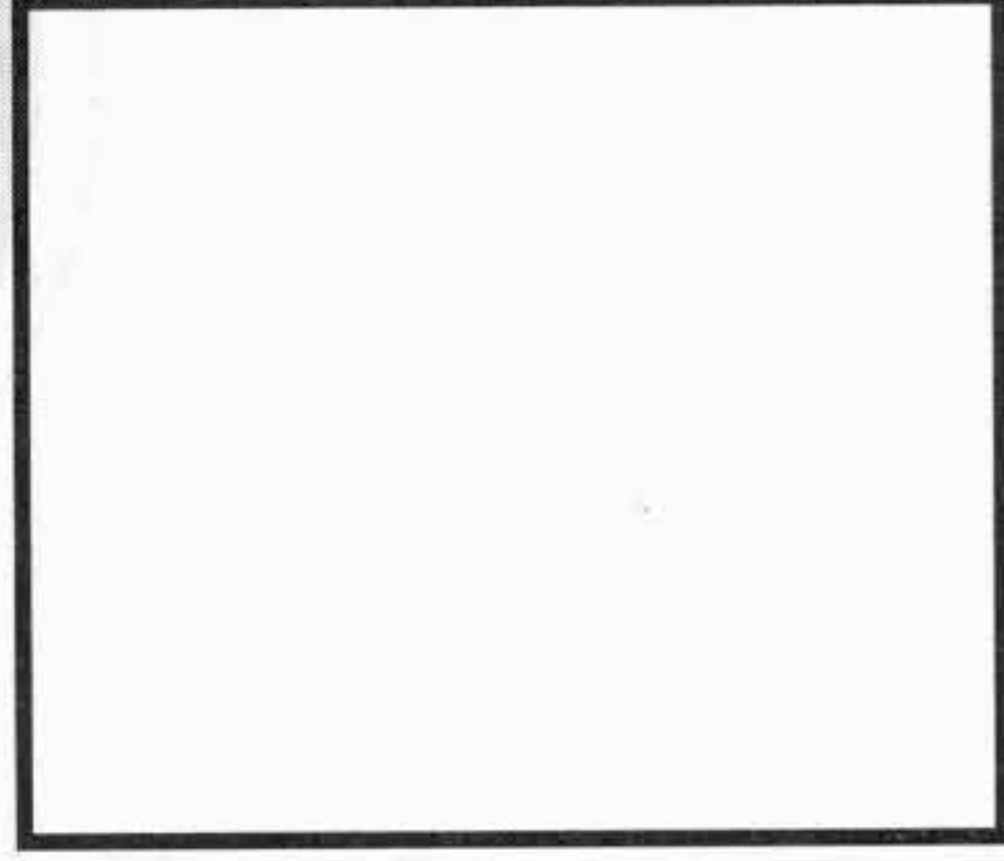
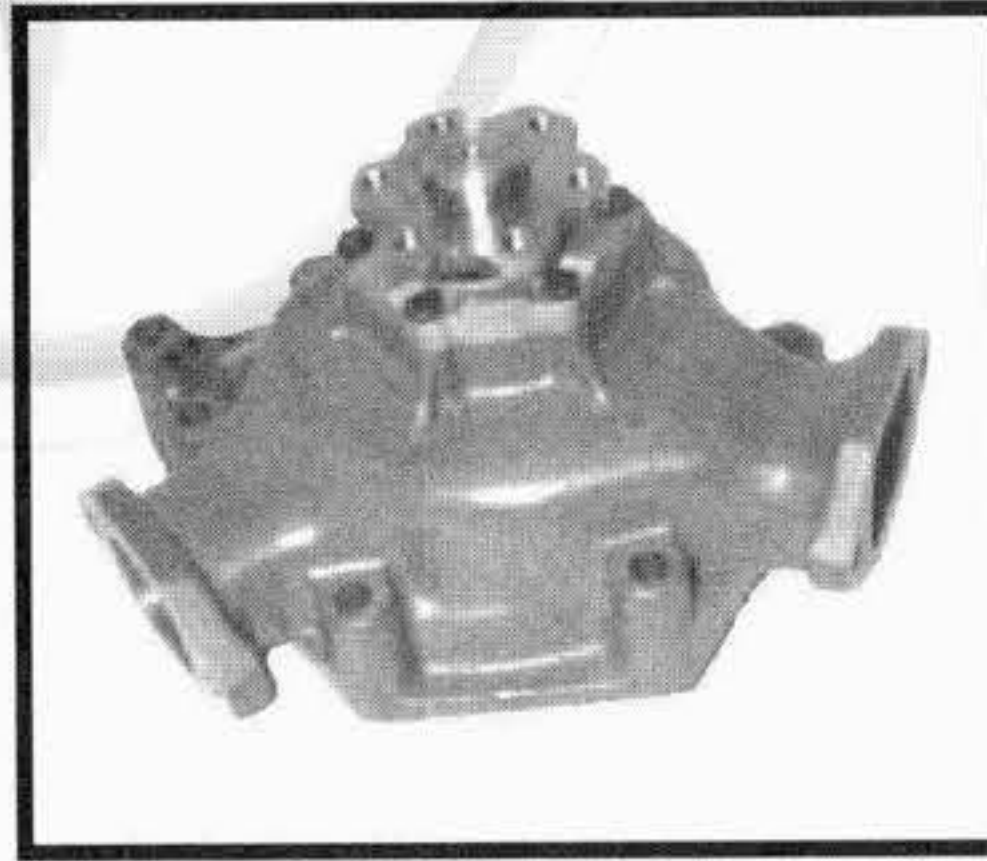
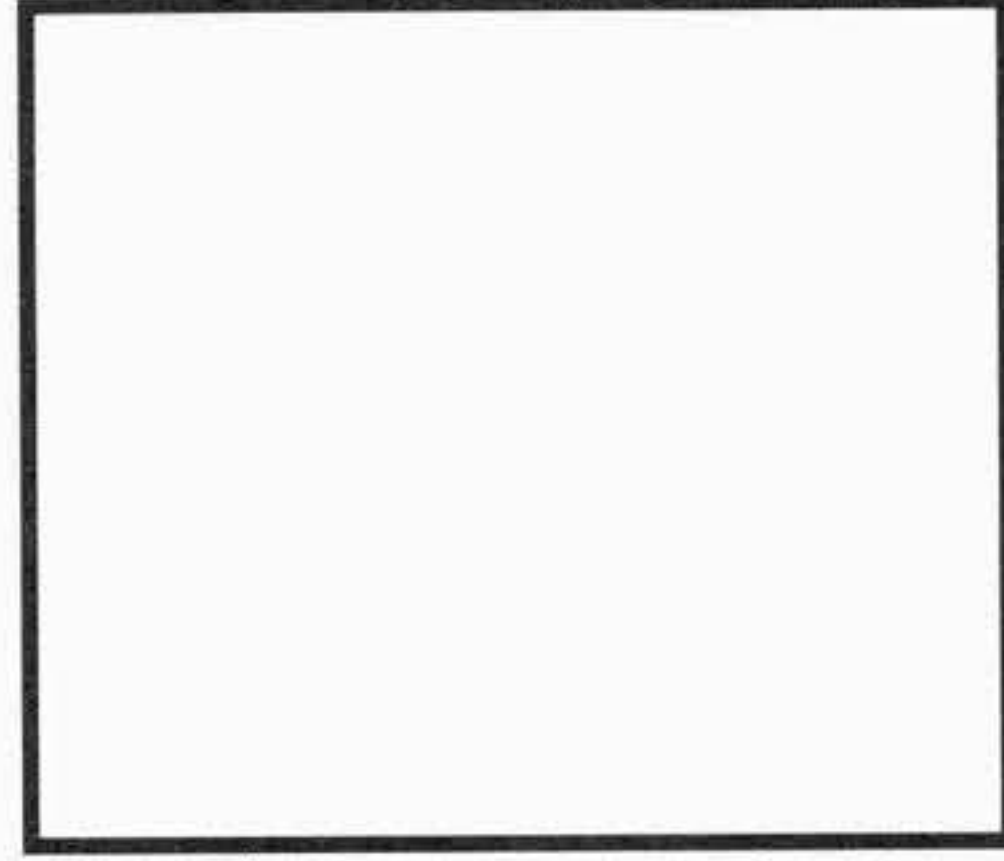
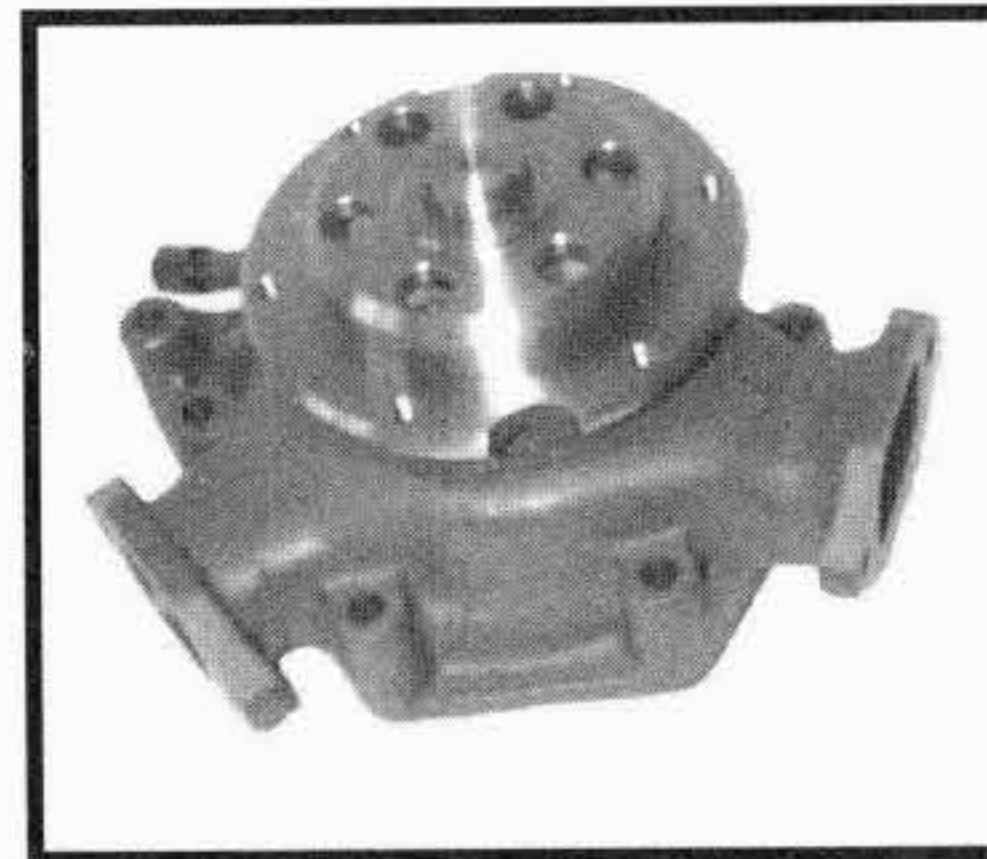
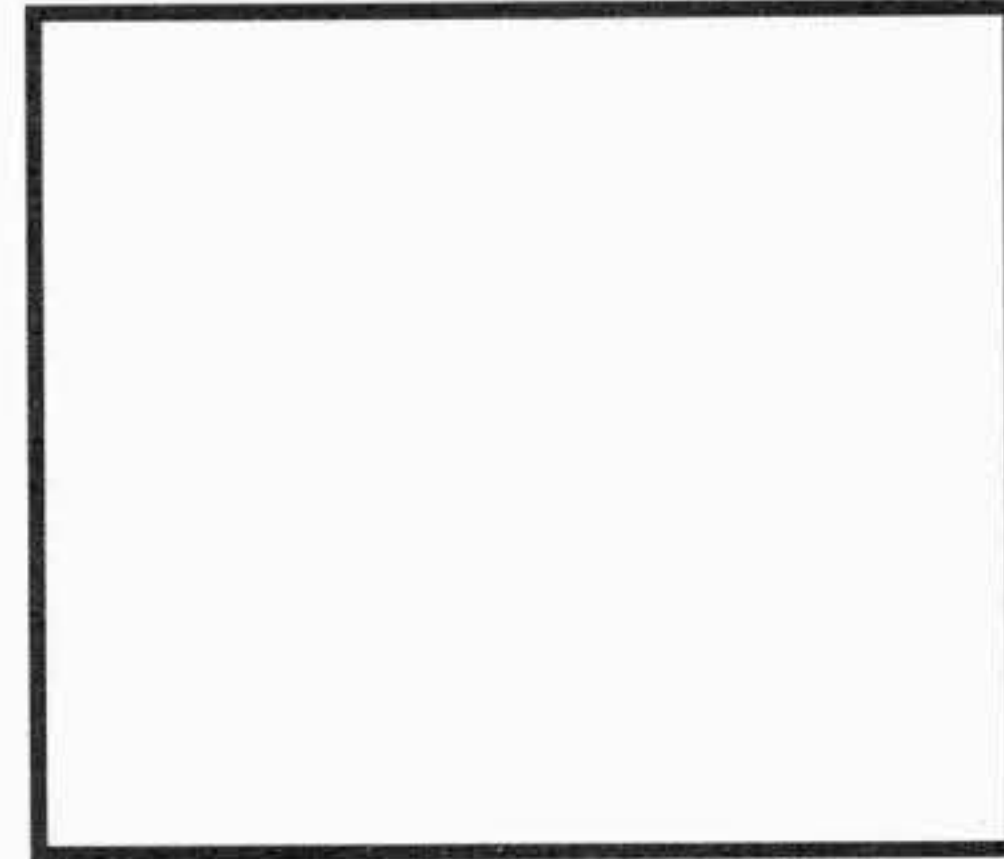
TIPO O MODELLO TYPE OU MODELE TYPE OR MODEL	MOTORE MOTEUR ENGINE	POMPA ACQUA POMPE A EAU WATER PUMP OMP REF. / O.EM. REF	KIT RIPARAZIONE NECESSAIRE DE REP. REPAIR KIT OMP REF. / O.EM. REF
LP 810 LP 813 911 B 1217 S 1419 C / CL / L / LS 1420 - 1420 L 1617 1619 C 1620 2219 - 2219 CL 2220 2222	OM 352.985 OM 362 OM 362 LA	241.940 353.200.56.01  albero con foro filettato / shaft with threaded bore girante / impeller Ø 95 mm	242.230 352.200.45.04 
L / LA 329 - L / LA / LP 331 L / LA 332 - LP 333 - L / LP 334 LP / LPS 1418 - LAK 1518 - 1618 1620 - 1623 - 1920 - 2023 2024 - 2220 - 2620 1620 - 1624 - 2223 2224 - 2624 1920 1924 - 2023 - 2024 2220 - 2224 - 2624	OM 346.910 OM 346.912 - 917 OM 346.919 OM 355.912 OM 355.914 OM 355.913 OM 355.910	241.760 355.200.00.01  	242.075 355.200.05.04 
OH 1419 OH 1517 OH 1519 1924 1929 2219	OM 355 BRAZIL 5 cyl. - 6 cyl.	241.955 345.200.71.01  girante / impeller Ø 120 mm	242.161 355.200.14.04 
1424 1621 L / LA / LAP 1624 1921 L / LA / LAP 1924 1928 LPS 2024 LP 2223 2224 - LP 2224 L / LA / LK 2624 2628	OM 355 - 6 cyl.	241.800 355.200.08.01  girante / impeller Ø 115 mm	242.076 355.200.13.04 

I ricambi non sono originali ma adattabili . Ogni riferimento originale é assolutamente indicativo .

Spare parts are not original but perfectly suitable . Every original part number has to be considered for reference purpose only .

SUITABLE

MERCEDES BENZ

AUTOCARRI - CAMIONS - TRUCKS



Tel: +44(0)1925 850082 Fax: +(0)44 1925 850083

www.spwaterpumps.co.uk

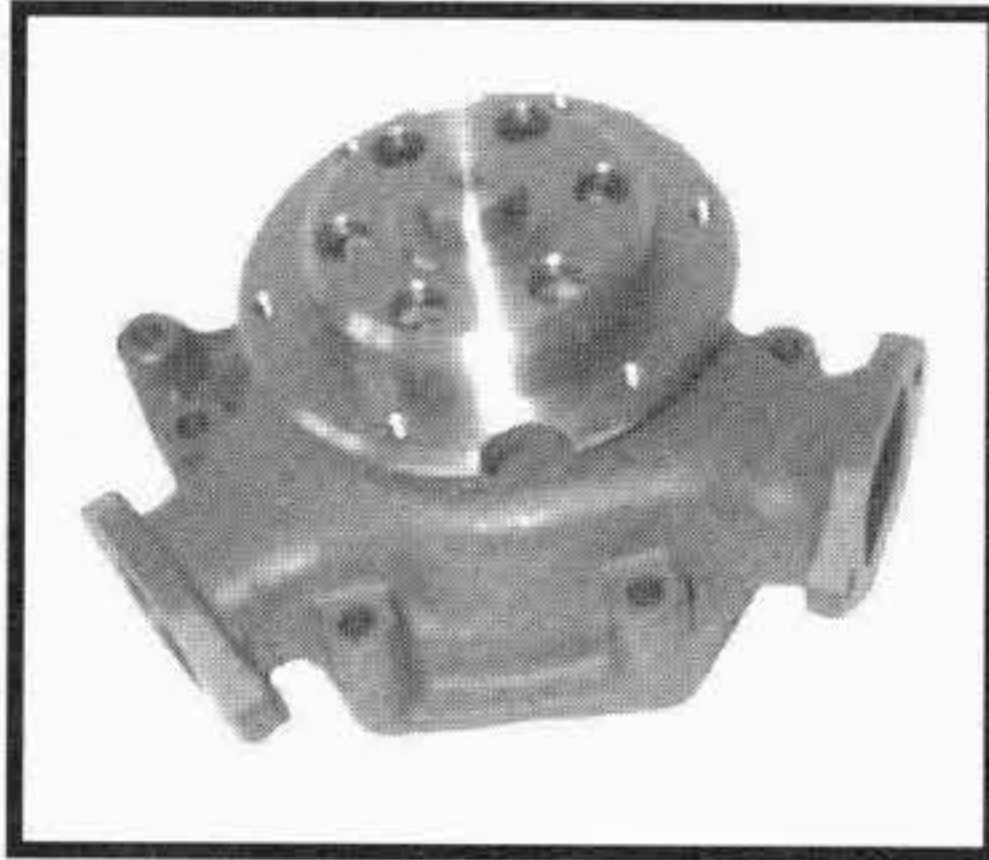
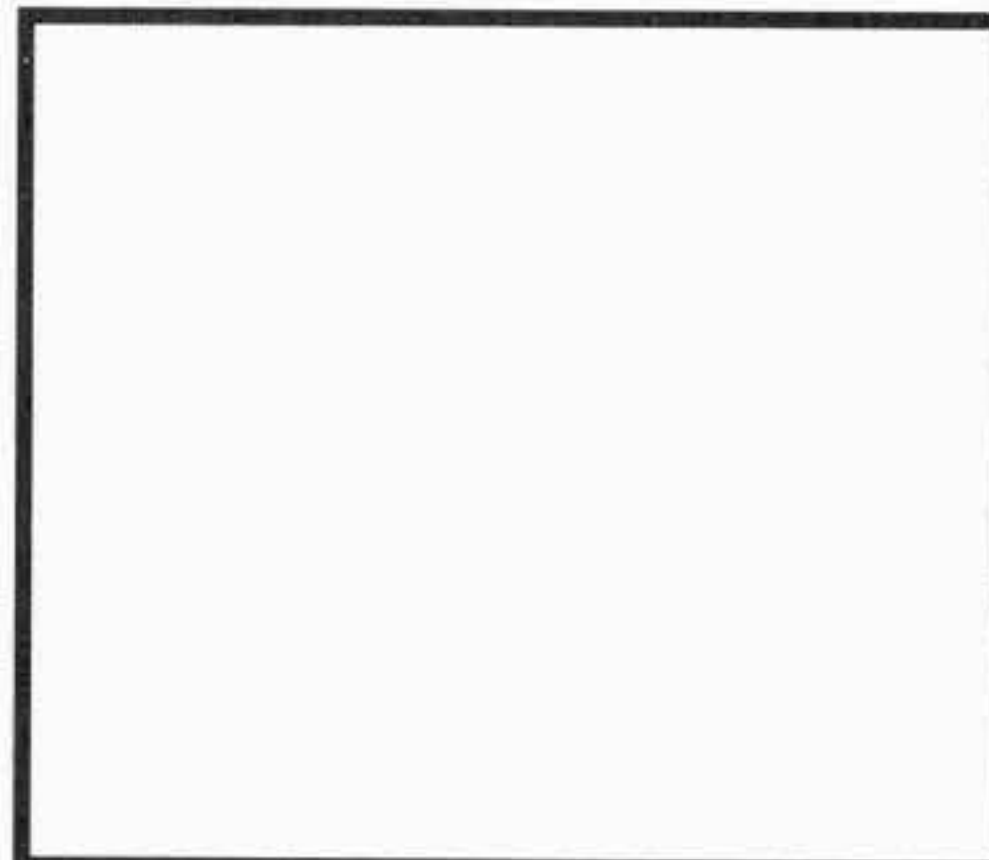
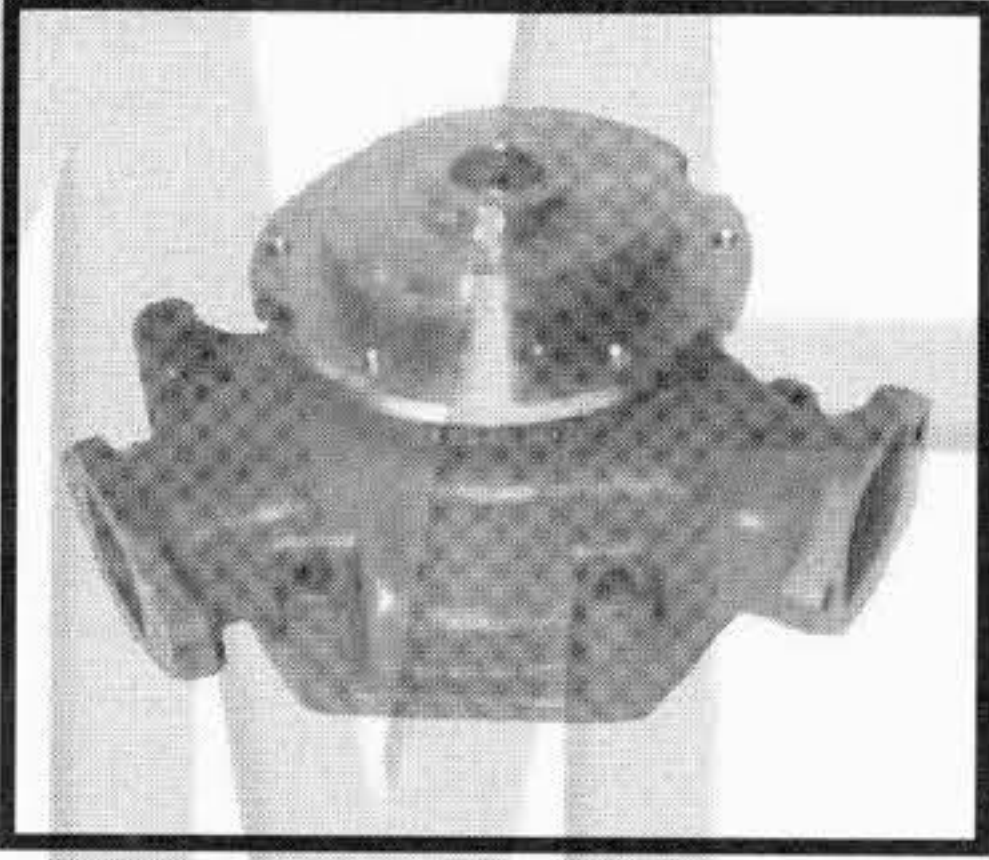
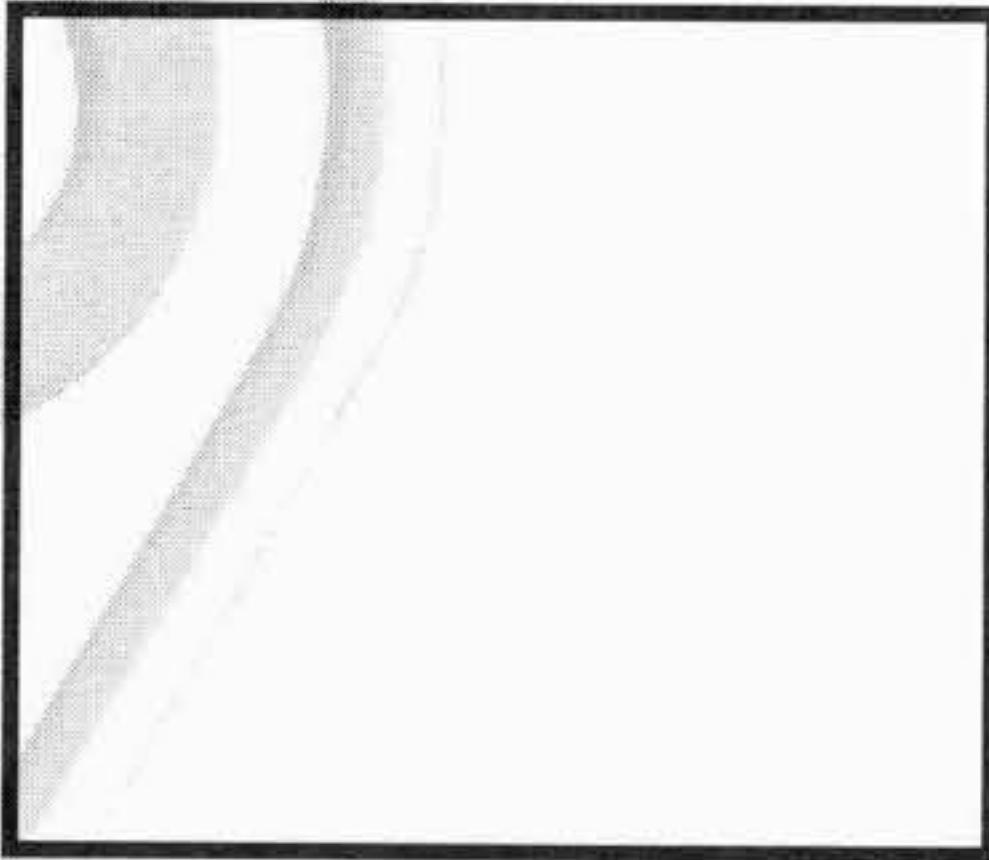
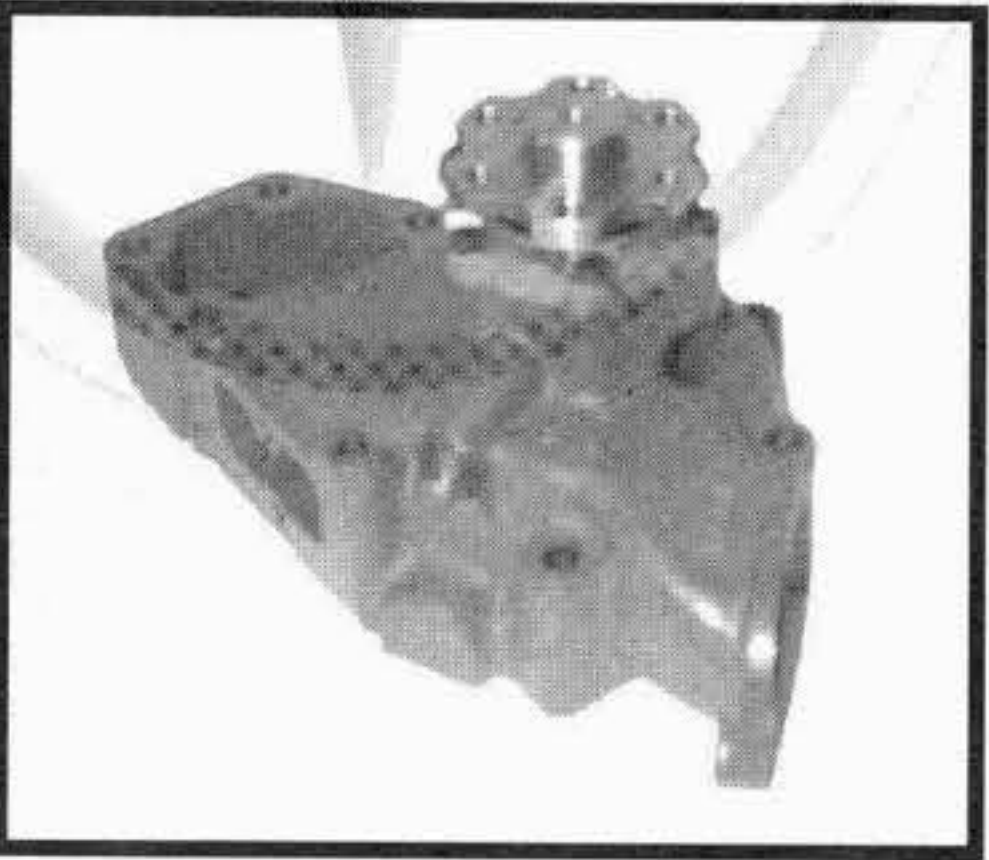
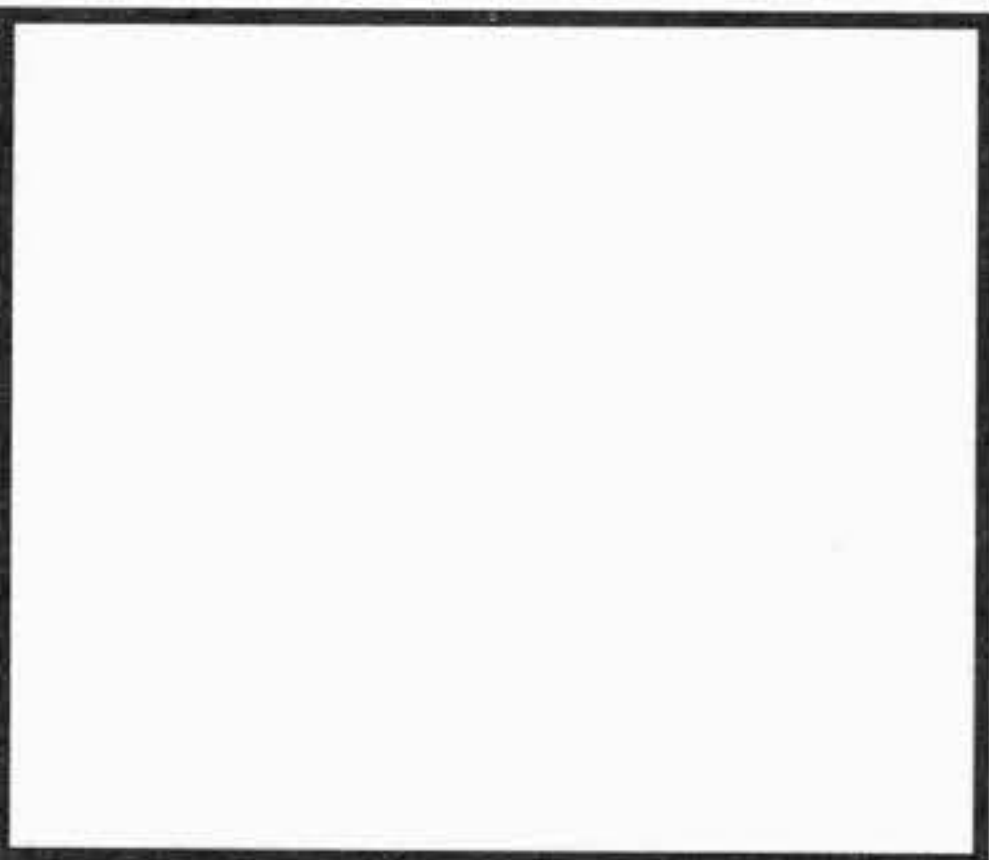
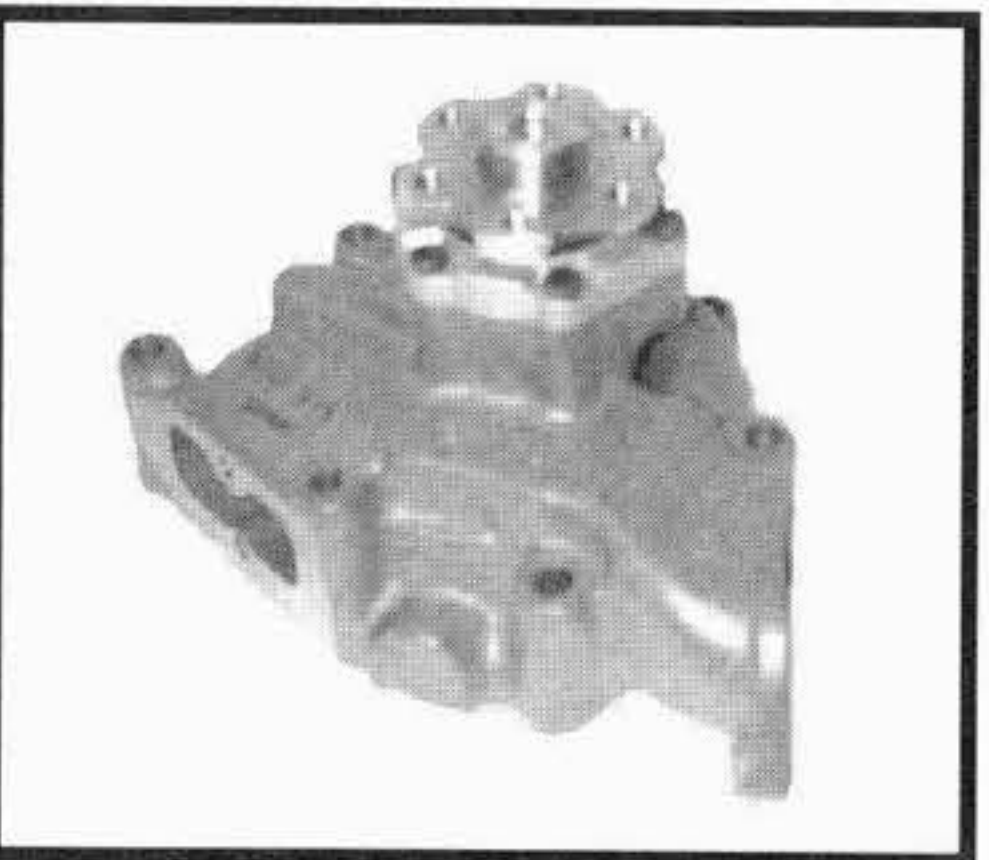
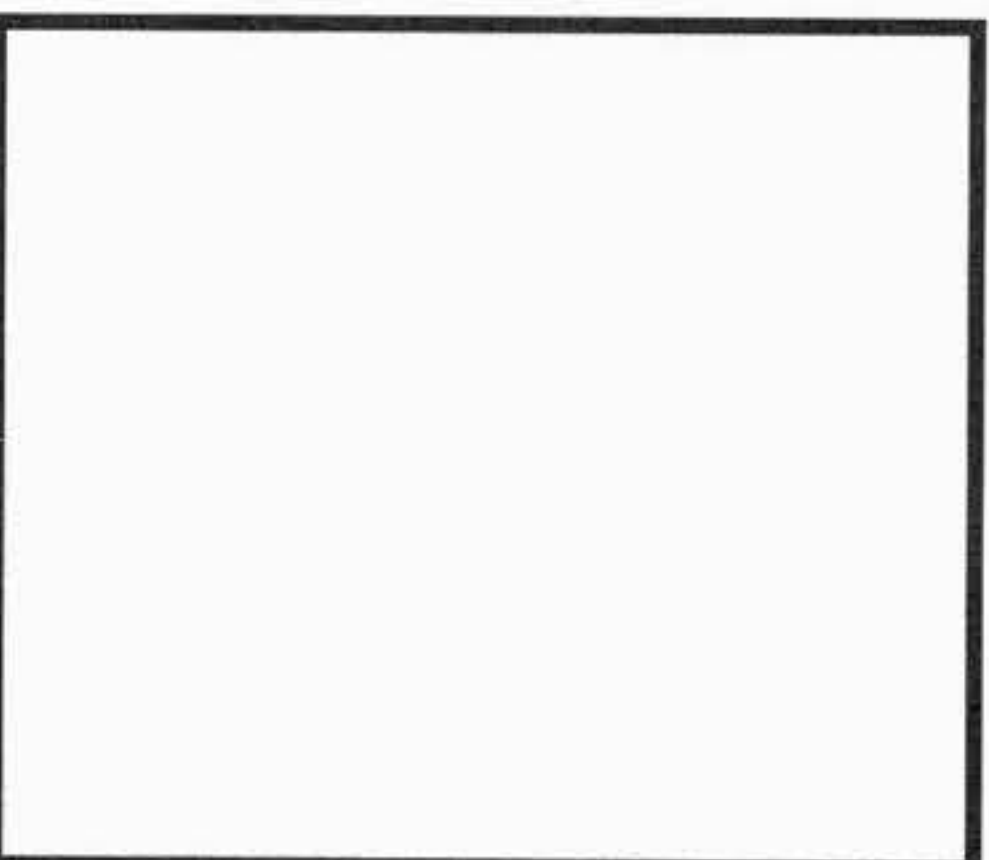
TIPO O MODELLO TYPE OU MODELE TYPE OR MODEL	MOTORE MOTEUR ENGINE	POMPA ACQUA POMPE A EAU WATER PUMP OMP REF. / O.EM. REF	KIT RIPARAZIONE NECESSAIRE DE REP. REPAIR KIT OMP REF. / O.EM. REF
<p>1424 1621 L / LA / LAP 1624 1921 L / LA / LAP 1924 1928 LPS 2024 LP 2223 2224 - LP 2224 L / LA / LK 2624 2628</p>	<p>OM 355 - 6 cyl.</p>	<p>241.890 355.200.09.01</p>  <p>girante / impeller Ø 120 mm</p>	<p>242.161 355.200.14.04</p> 
<p>1424 1621 L / LA / LAP 1624 1921 L / LA / LAP 1924 1928 LPS 2024 LP 2223 2224 - LP 2224 L / LA / LK 2624 2628</p>	<p>OM 355 - 6 cyl.</p>	<p>241.905 355.200.15.01</p>  <p>con albero cuscinetto / with shaft bearing girante / impeller Ø 120 mm</p>	<p>242.212 355.200.12.04</p> 
<p>LP 1317 - OF 1317 OF 1417 LP 1517 LP 1519 LP 1617 1619 OF 1621 2219</p> <p><i>autocarri con guida a sinistra camions avec conduite a gauche trucks with left-hand drive</i></p>	<p>OM 360</p>	<p>241.735 360.200.45.01</p>  <p>albero senza foro filettato / shaft without threaded bore</p>	<p>242.071 360.200.06.04</p> 
<p>LP 1317 - OF 1317 1319 OF 1417 LA 1517 - LP 1517 LA 1519 - LP 1519 LP 1617 1619 OF 1621 1817 - 1819 - 2219</p>	<p>OM 360</p>	<p>241.740 360.200.46.01</p>  <p>albero con foro filettato / shaft with threaded bore</p>	<p>242.058 360.200.07.04</p> 

I ricambi non sono originali ma adattabili . Ogni riferimento originale é assolutamente indicativo .
Spare parts are not original but perfectly suitable . Every original part number has to be considered for reference purpose only .

SUITABLE





MERCEDES BENZ

AUTOCARRI - CAMIONS - TRUCK

Tel:+44(0)1925 850082 Fax: +(0)44 1925 850083

www.spwaterpumps.co.uk

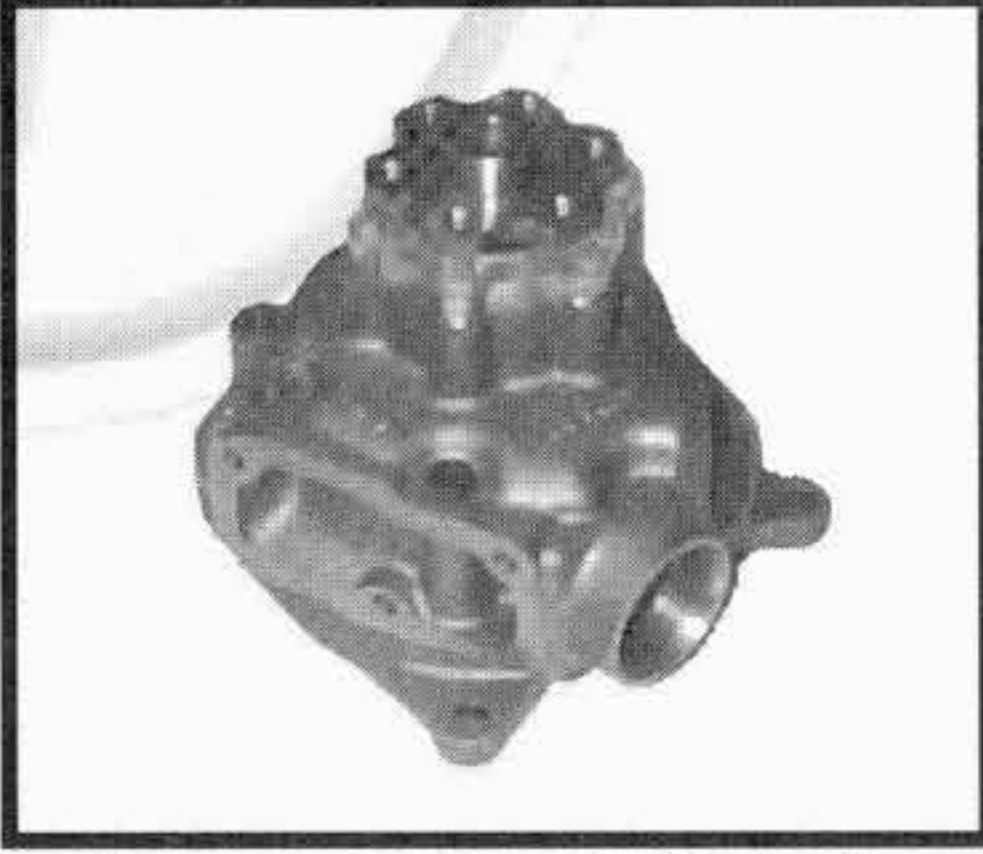
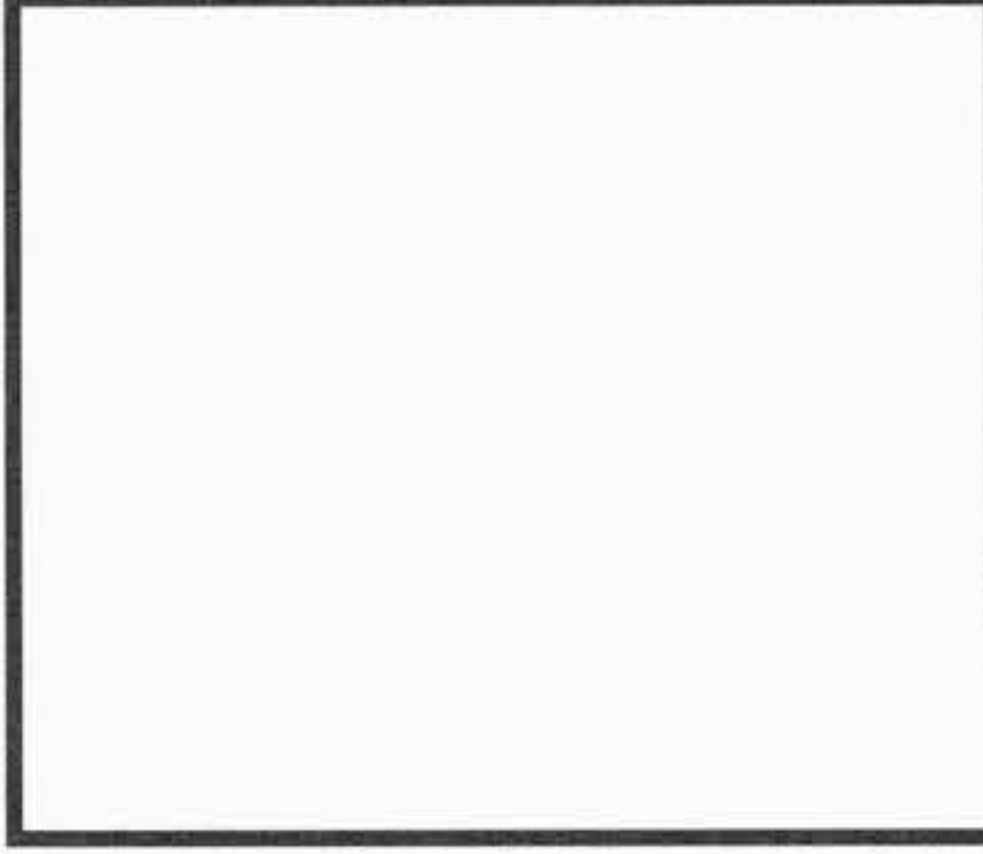
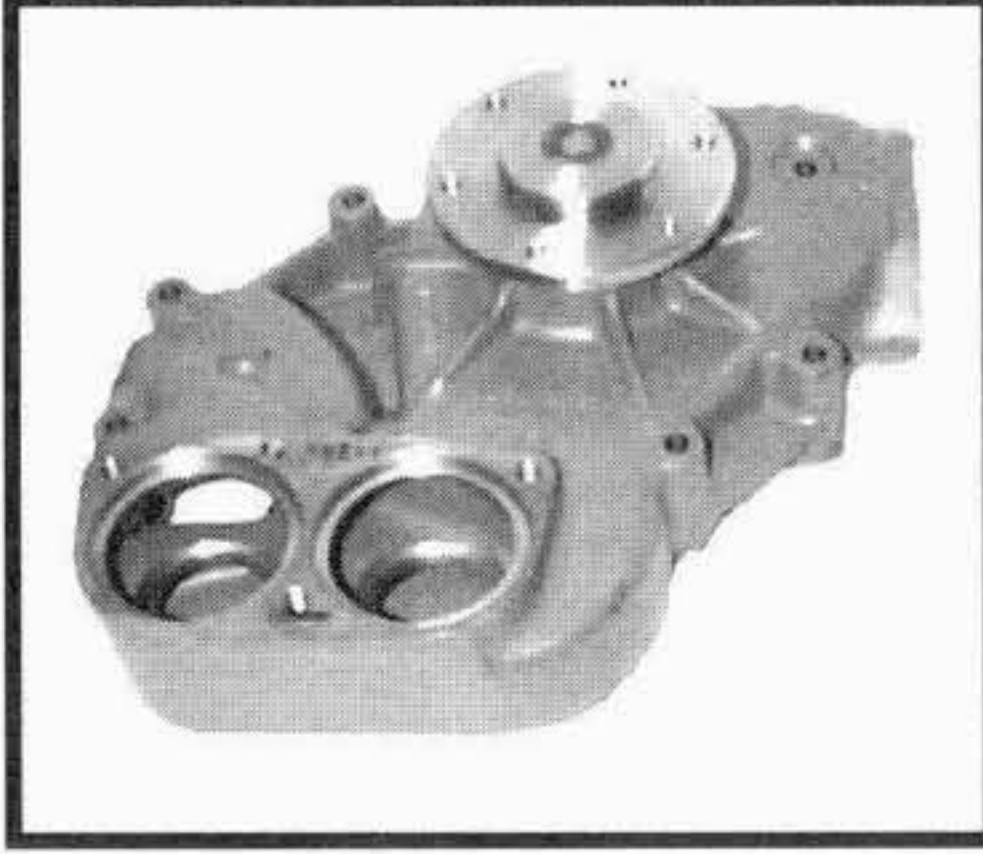
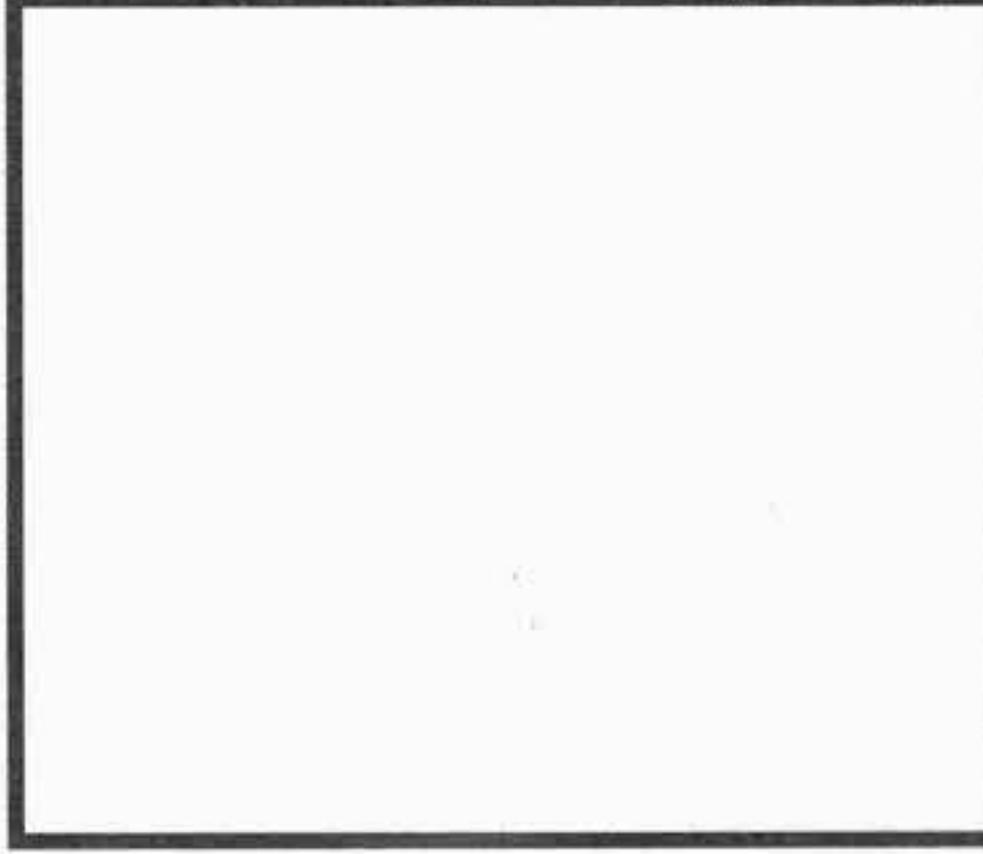

TIPO O MODELLO TYPE OU MODELE TYPE OR MODEL	MOTORE MOTEUR ENGINE	POMPA ACQUA POMPE A EAU WATER PUMP OMP REF. / O.EM. REF	KIT RIPARAZIONE NECESSAIRE DE REP. REPAIR KIT OMP REF. / O.EM. REF
609 - 609 DS 709 D 809 711 811 814 D	OM 364 OM 364 A	<p>241.965 364.200.20.01</p>  <p>albero con foro filettato / shaft with threaded bore girante / impeller Ø 95 mm</p>	<p>242.248 364.200.08.04</p> 
814 - 914 - 1114 1314 - 1414 - 1614 817 - 917 - 1117 - 1317 1417 - OH 1417 - 1517 - 1617 1017 - 1120 - 1320 - 1320 S 1324 - 1419 C / CL / L / LS 1520 - 1524 - 1617 - 1619 1620 - 1720 NAW - 2219 2220 - 2222	OM 366 OM 366 A OM 366 LA	<p>241.975 366.200.59.01</p>  <p>albero con foro filettato / shaft with threaded bore girante / impeller Ø 95 mm</p>	<p>242.249 366.200.08.04</p> 
817 - 917 - 1117 - 1317 1417 - 1517 1120 - 1320 - 1320 1520 - 1720 - 1820	OM 366 LA EURO II 357.900 ÷ 919 125 kW ÷ 170 CV OM 366 LA EURO II 357.920 ÷ 927 155 kW ÷ 211 CV	<p>241.985 366.200.60.01</p>  <p>albero con foro filettato / shaft with threaded bore girante / impeller Ø 95 mm</p>	<p>242.249 366.200.08.04</p> 
1019 - 1219 - 1419 F / L / LS / S 1424 / F - 1619 L - 1619 S 1719 - 1819 - 1919 2219 / L / K - 2419 1624 - 1626 K / L / LP - 1924 L 1926 K / AK - 2026 - 2224 B / K 2226 - 2626 AB / AK 1626 K / L / LP - 1632 K / L / LP 1926 - 1932 - 2032 6x2 - 2226 2232 - 2626 AB / AK 2632 AK / AS - 3032 8x4 2421	OM 401 --> mot. 129660 OM 402 --> mot. 129660 OM 403 --> mot. 129660 OM 421	<p>241.825 403.200.70.01</p>  <p>note : girante / impeller Ø 125 mm</p>	<p>242.181 422.200.03.04</p> 

I ricambi non sono originali ma adattabili . Ogni riferimento originale é assolutamente indicativo .
Spare parts are not original but perfectly suitable . Every original part number has to be considered for reference purpose only .

SUITABLE

MERCEDES BENZ

AUTOCARRI - CAMIONS - TRUCKS

Tel:+44(0)1925 850082 Fax: +(0)44 1925 850083

www.spwaterpumps.co.uk

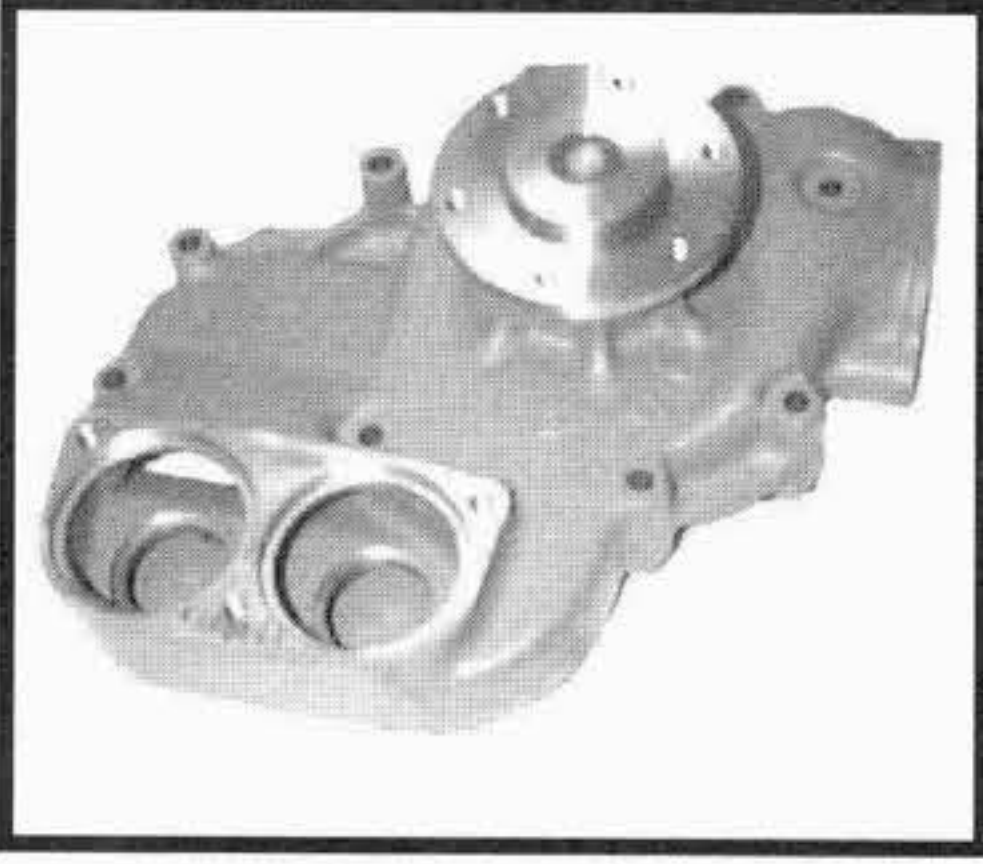
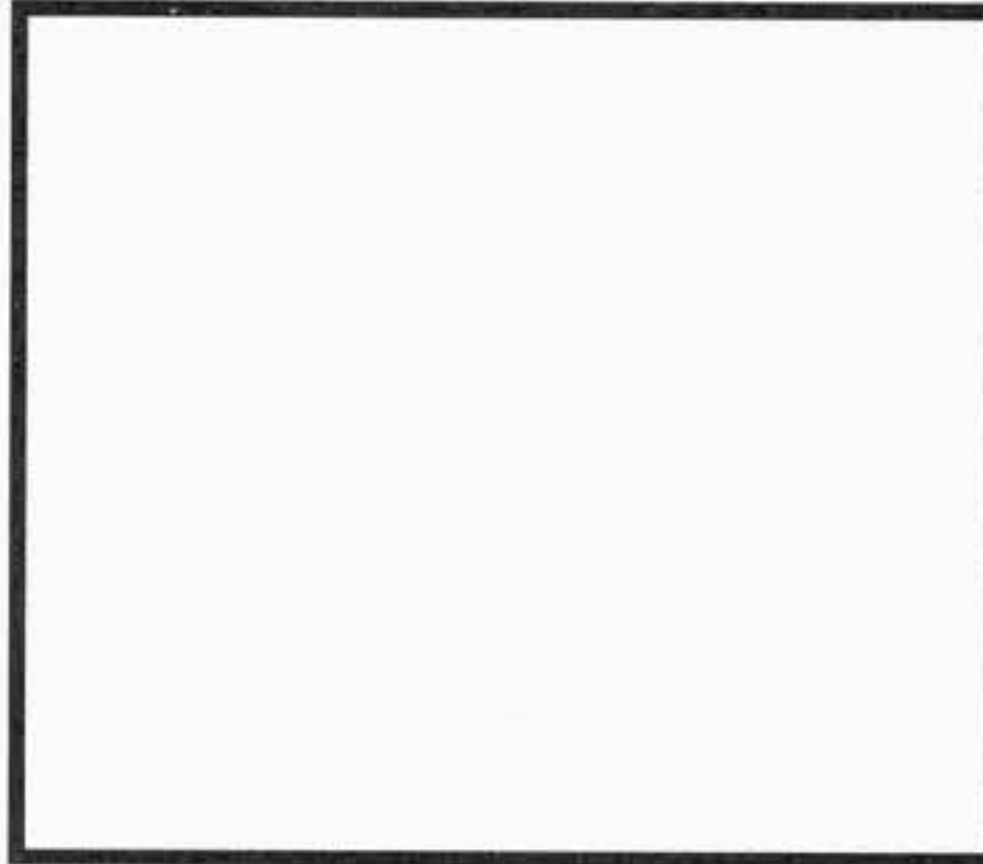
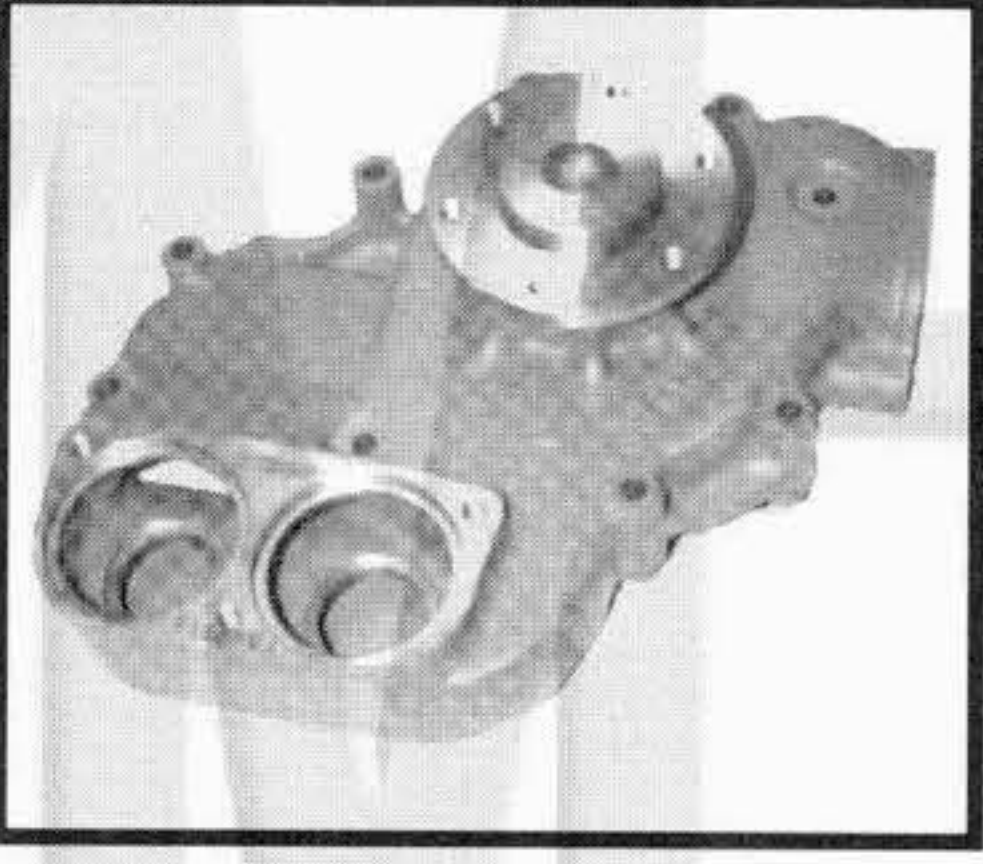
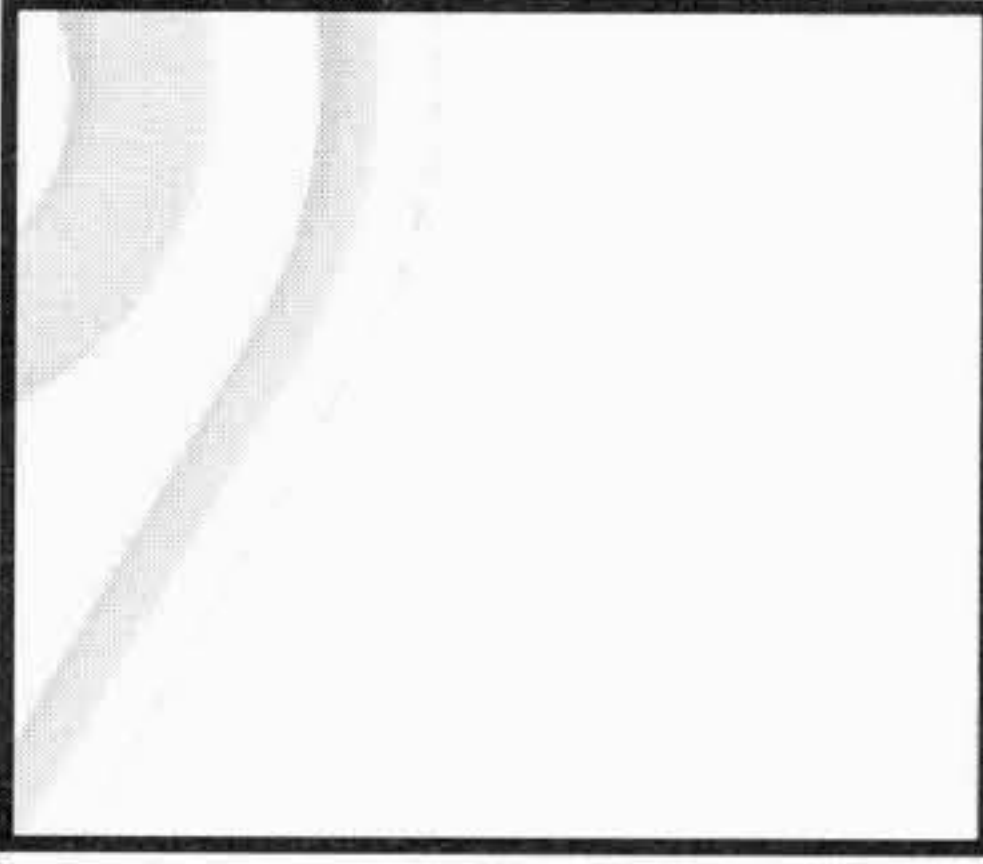
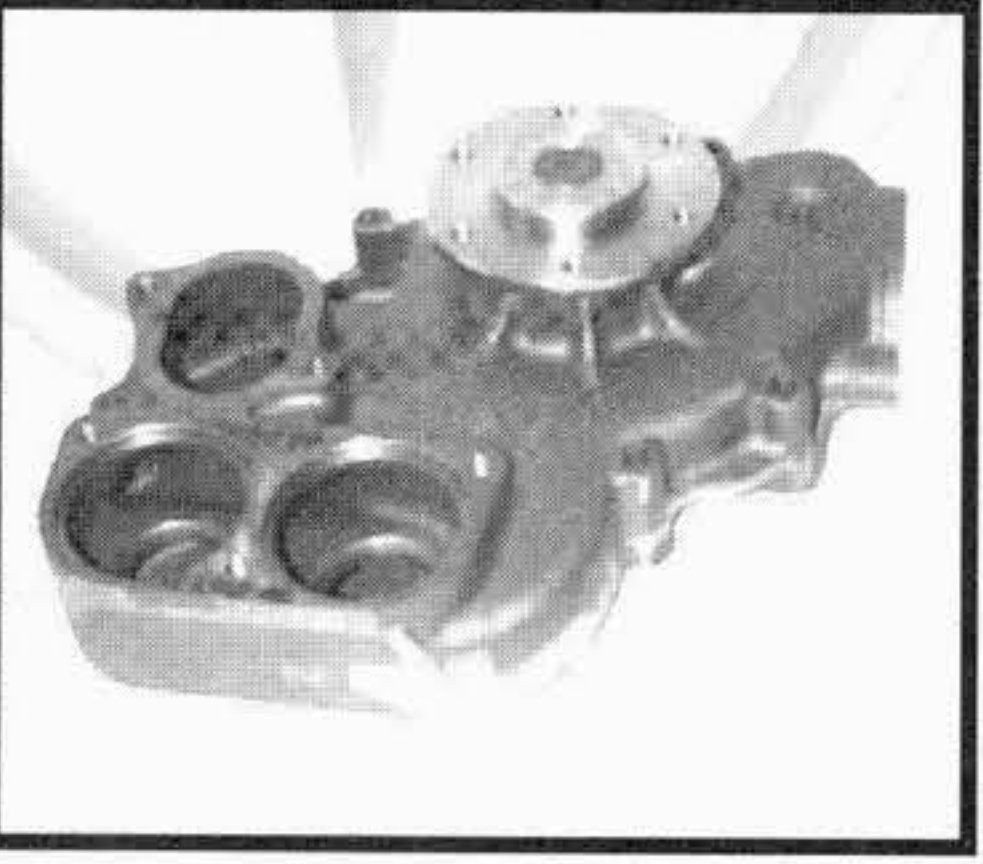
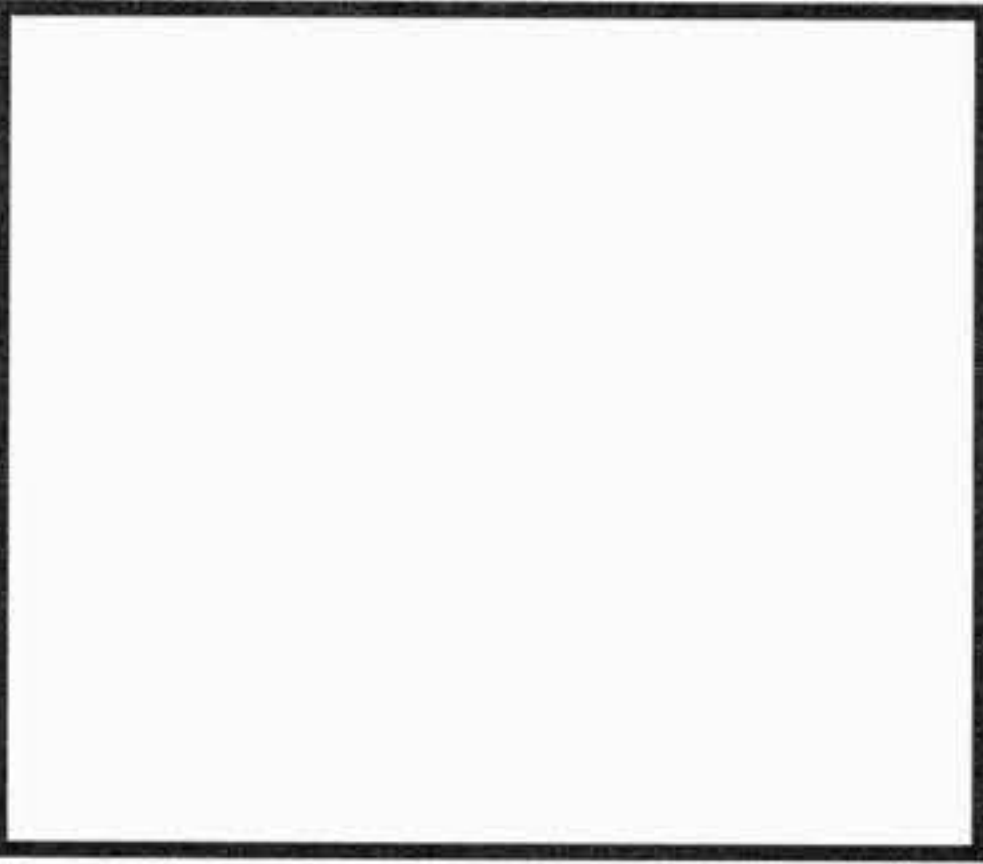
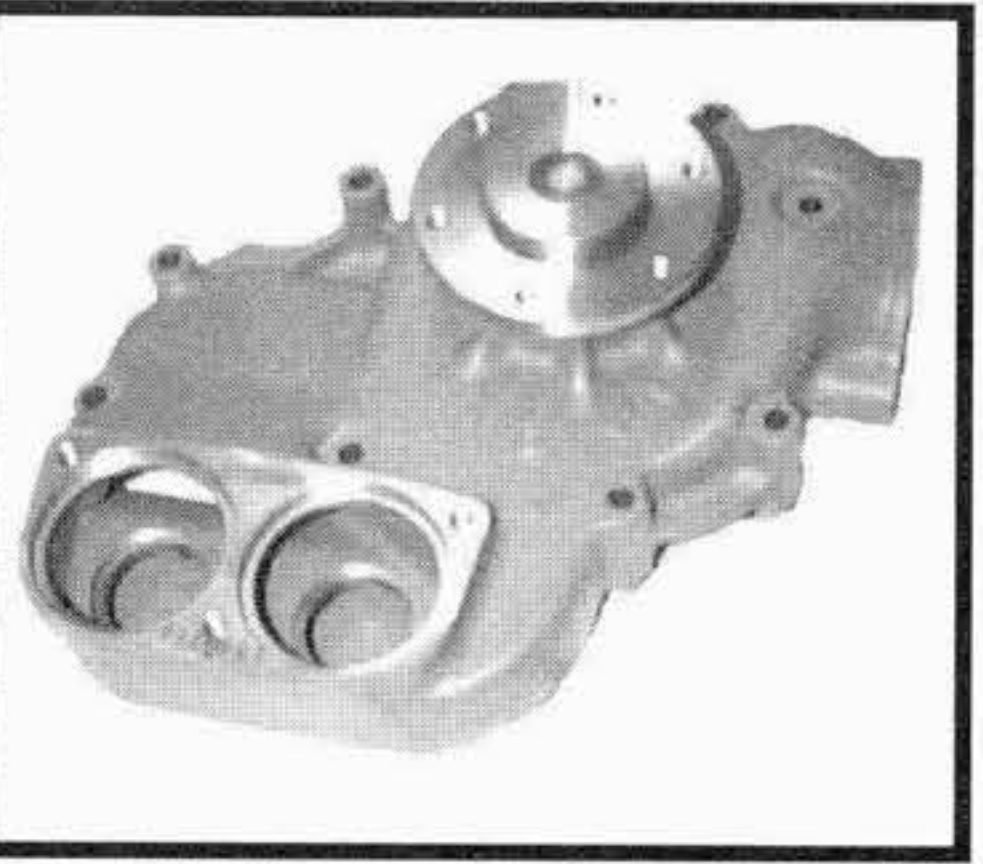
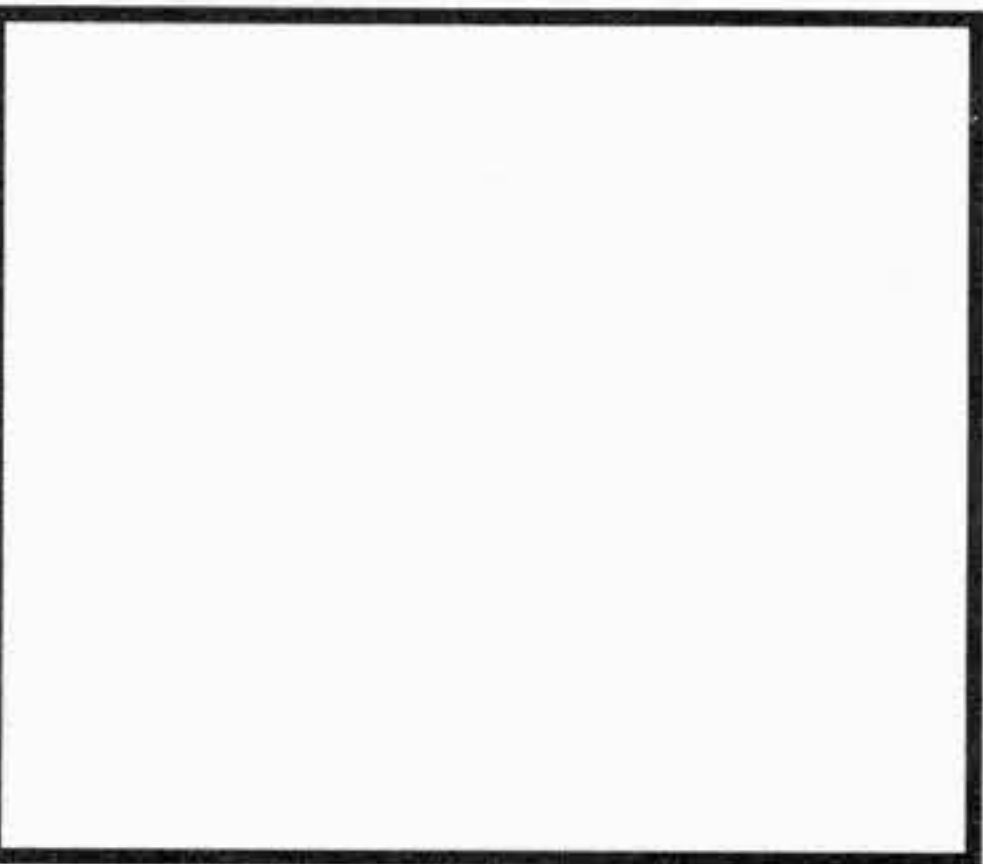

TIPO O MODELLO TYPE OU MODELE TYPE OR MODEL	MOTORE MOTEUR ENGINE	POMPA ACQUA POMPE A EAU WATER PUMP OMP REF. / O.EM. REF	KIT RIPARAZIONE NECESSAIRE DE REP. REPAIR KIT OMP REF. / O.EM. REF
1019 - 1219 - 1419 F/L/LS/S - 1424 / F 1619 L - 1619 S - 1719 - 1819 - 1919 2219 / L / K - 2419 1624 - 1626 K / L / LP - 1924 L - 1926 K / AK 2026 - 2224 B / K - 2226 - 2626 AB / AK 1626 K / L / LP - 1632 K / L / LP - 1926 - 1932 2032 6 x 2 - 2226 - 2232 - 2626 AB / AK 2632 AK / AS - 3032 8 x 4 1222 - 1422 - 1621 S - 1622 OH 1622 - 1922 - 2221 1425 - 1625 - 1628 - 1928 - 2025 - 2028 - 2225 2228 - 2628 - 3025 - 3028 - 3228 - 3328 1633 - 1933 - 2033 - 2233 - 2633 - 3333 8 X 4 1638 - 1938 - 2238 - 2638 1636 - 1936 - 2036 - 2236 - 2636 - 3333 8 X 4 1222 - 1422 - 1622 - 1722 - 1922 2222 - 2225 - 2422 - 2426 - 2429 1628 - 1733 - 2228 - 2433 1426 - 1625 - 1726 - 1729 - 1928 - 1929 2225 - 2422 - 2426 - 2429 - 2629 - 3529 1635 - 1635 L - 1735 - 1935 - 2035 S / LS 2235 - 2435 - 2635 - 3235 - 3535 1644 - 1748 - 1944 - 1944 S 1948 - 2244 - 2448 - 2644 - 2648	OM 401 mot. 129661 --> OM 402 mot. 129661 --> OM 403 mot. 129661 --> OM 421 OM 422 OM 422 A OM 422 LA OM 423 OM 441 --> mot. 504397 OM 441 LA --> mot. 504397 OM 442 --> mot. 504397 OM 442 A --> mot. 504397 OM 442 LA --> mot. 504397	<p>241.835 403.200.71.01</p>  <p>note : girante / impeller Ø 125 mm</p>	<p>242.181 422.200.03.04</p> 
1222 - 1422 - 1622 - 1722 - 1922 - 2222 2225 - 2422 - 2426 - 2429 1628 - 1733 - 2228 - 2433 1426 - 1625 - 1726 - 1729 - 1928 - 1929 2225 - 2422 - 2426 - 2429 - 2629 - 3529 1635 - 1635 L - 1735 - 1935 - 2035 S/LS 2235 - 2435 - 2635 - 3235 - 3535 1644 - 1748 - 1944 - 1944 S 1948 - 2244 - 2448 - 2644 - 2648 1827 - 1831 - 1834 - 2531 - 2534 ECOLINER 1838 - 2038 - 2538 - 1844 - 2044	OM 441 mot. 504398 --> OM 441 LA mot. 504398 --> OM 442 mot. 504398 --> OM 442 A mot. 504398 --> OM 442 LA mot. 504398 --> OM 441 LA OM 442 LA	<p>241.995 441.200.02.01</p>  <p>note : girante / impeller Ø 125 mm</p>	<p>242.265 441.200.01.04</p> 
3236	OM 423.909	<p>241.950 403.200.74.01</p>  <p>note : girante / impeller Ø 125 mm</p>	<p>242.181 422.200.03.04</p> 
3250 3850 4050 ECOLINER 1850 - 2050	OM 423 LA	<p>241.960 422.200.10.01</p>  <p>note : girante / impeller Ø 135 mm</p>	<p>242.237 422.200.04.04</p> 

I ricambi non sono originali ma adattabili . Ogni riferimento originale é assolutamente indicativo .
 Spare parts are not original but perfectly suitable . Every original part number has to be considered for reference purpose only .

SUITABLE





MERCEDES BENZ

AUTOCARRI - CAMIONS - TRUCKS

Tel:+44(0)1925 850082 Fax: +(0)44 1925 850083

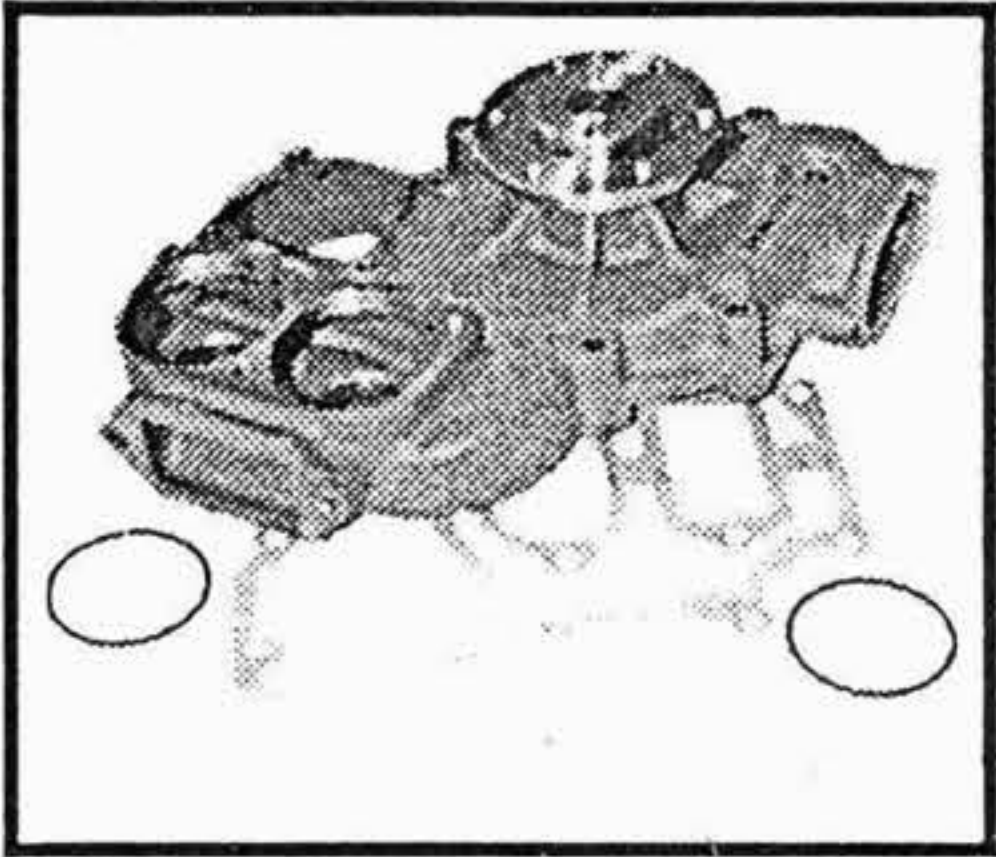
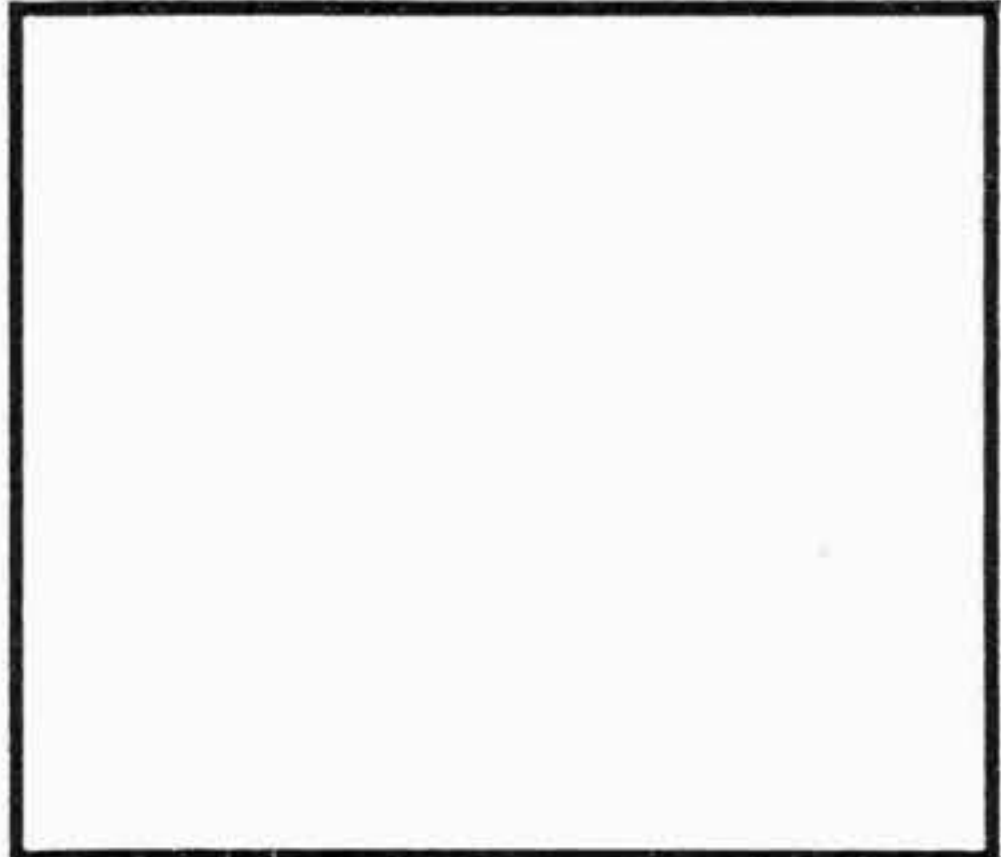
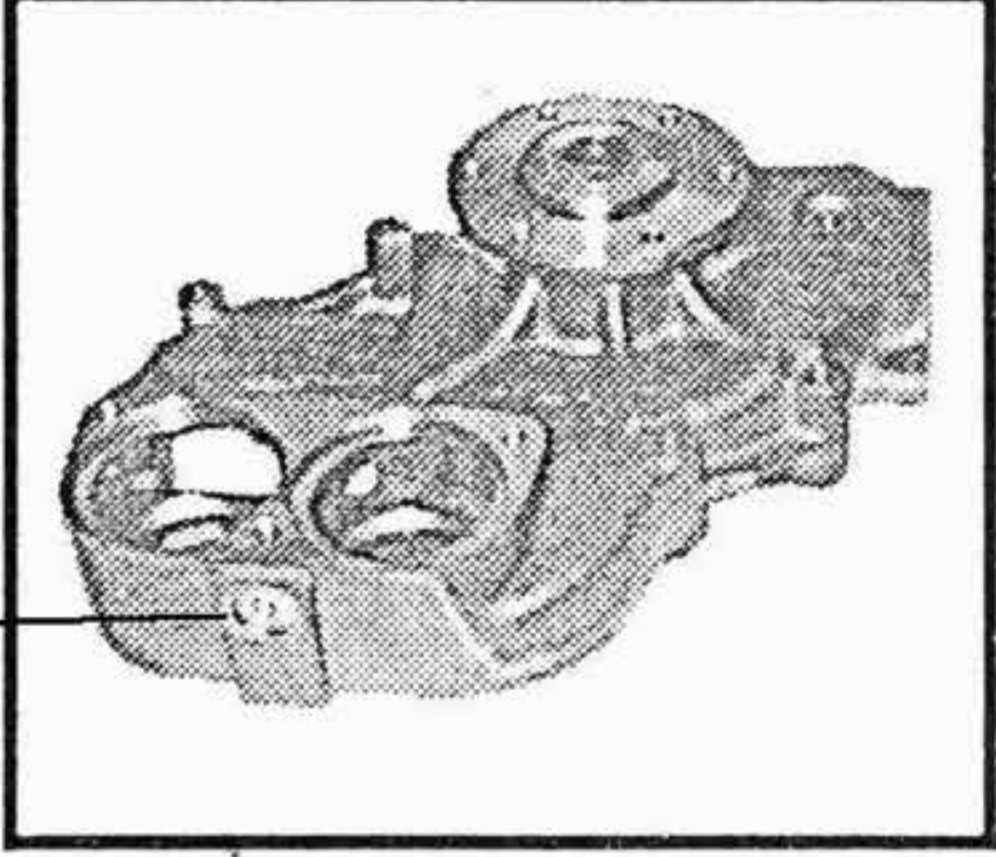
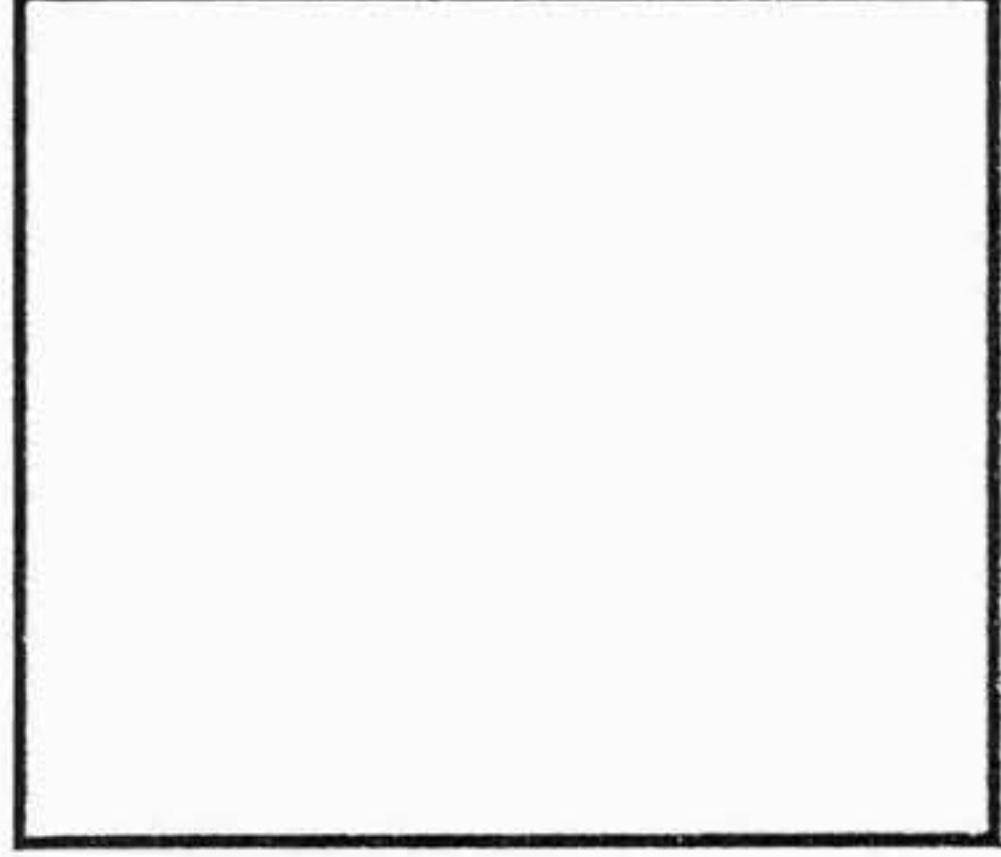
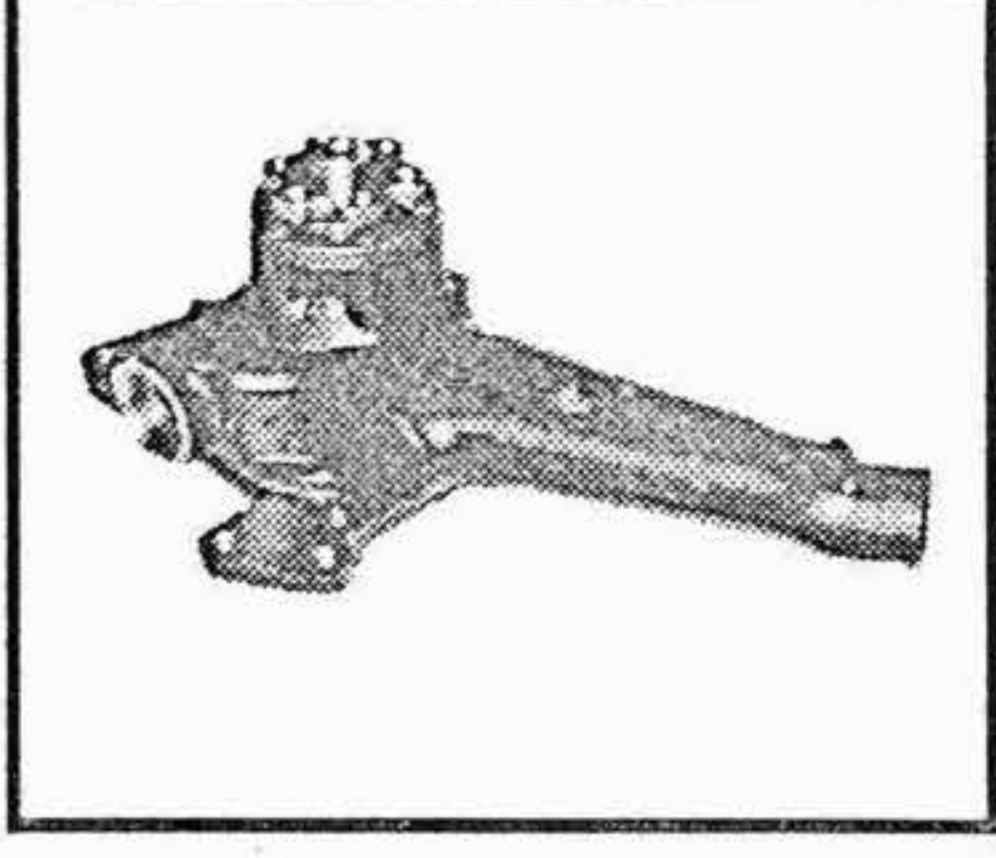
www.spwaterpumps.co.uk

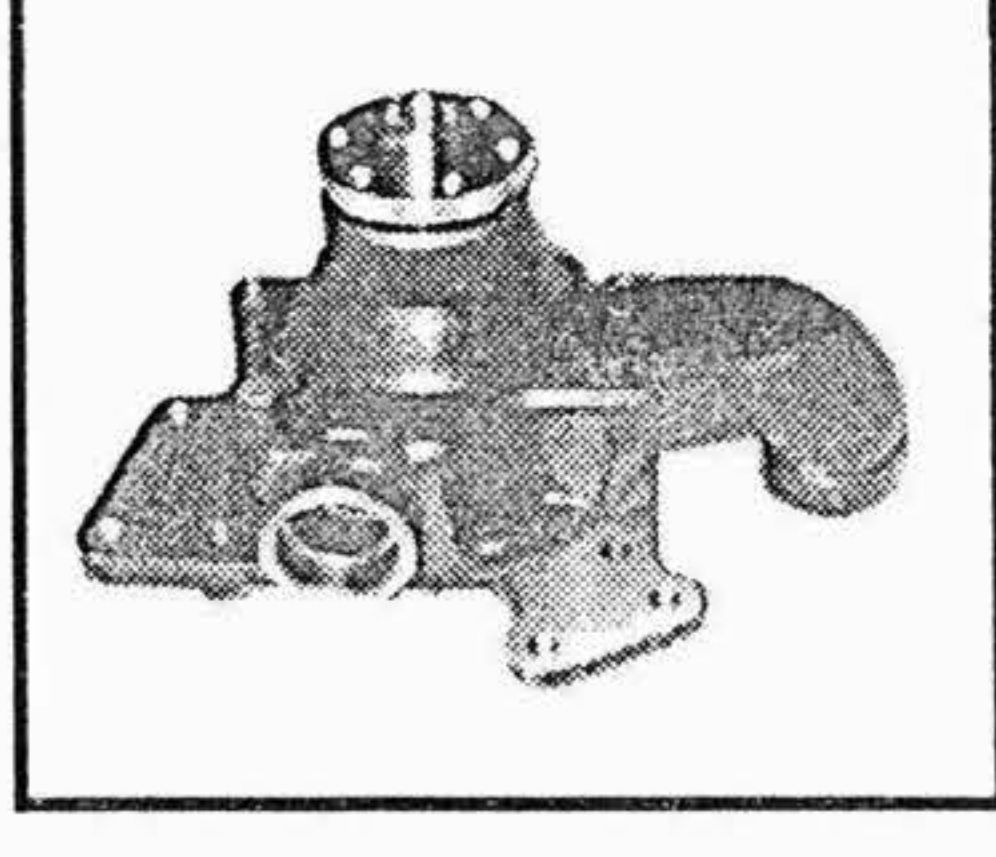

TIPO O MODELLO TYPE OU MODELE TYPE OR MODEL	MOTORE MOTEUR ENGINE	POMPA ACQUA POMPE A EAU WATER PUMP	KIT RIPARAZIONE NECESSAIRE DE REP. REPAIR KIT
<p>tutte le versioni con pompa iniezione a comando elettronico + RITARDATORE</p> <p>all version with electronic drive injection pump + RETARDER</p>	<p>OM 441 LA OM 442 LA</p>	<p>241.980 422.200.12.01</p>  <p>note : girante / impeller Ø 135 mm</p>	<p>242.237 422.200.04.04</p> 
<p>tutte le versioni con motore all version with engine</p> <p>NEW !!</p>	<p>OM 441 LA OM 442 LA</p> <p>Threaded Hole for Temperature Sensor</p>	<p>241.875 403.200.76.01</p>  <p>note : girante / impeller Ø 125 mm</p>	<p>242.181 422.200.03.04</p> 
<p>tutte le versioni con motore all version with engine</p> <p>NEW !!</p>	<p>OM366 / LA BRAZIL 1820</p>	<p>241.820 366.200.68.01</p> 	<p>242.249 366.200.08.04</p> 
<p>tutte le versioni con motore all version with engine</p> <p>NEW !!</p>	<p>OM366 / LA ECOLOGICO EPA 91 BRAZIL</p>	<p>241.880 376.200.05.01</p> 	<p>242.251 376.200.01.04</p> 

I ricambi non sono originali ma adattabili . Ogni riferimento originale é assolutamente indicativo .
Spare parts are not original but perfectly suitable . Every original part number has to be considered for reference purpose only .

SUITABLE

MERCEDES BENZ ENGINES

Tel: +44(0)1925 850082 Fax: +(0)44 1925 850083

www.spwaterpumps.co.uk



TIPO O MODELLO
TYPE OU MODELE
TYPE OR MODEL

MOTORE
MOTEUR
ENGINE

OMP REF. / O.E.M. REF

GUARNIZIONE IN METALLO PER METALLIC GASKET FOR

Pompa acqua / Water Pump

241.935 353.200.37.01

Kit di riparazione / Repair Kit

242.229 352.200.44.04

L / LA / LP / LAP 311 - 312

L / LA 322 - LF / LAF 323

L / LA / LP / LAP 327 - 328

710 - LF / LAF 710

L / LA / LP / LAP 911 - L / LA 911B

L / LA 1113 - LA 1313

1317 - LA 1513 - 1517 - 1813

OM 352

241.879

362.201.01.80

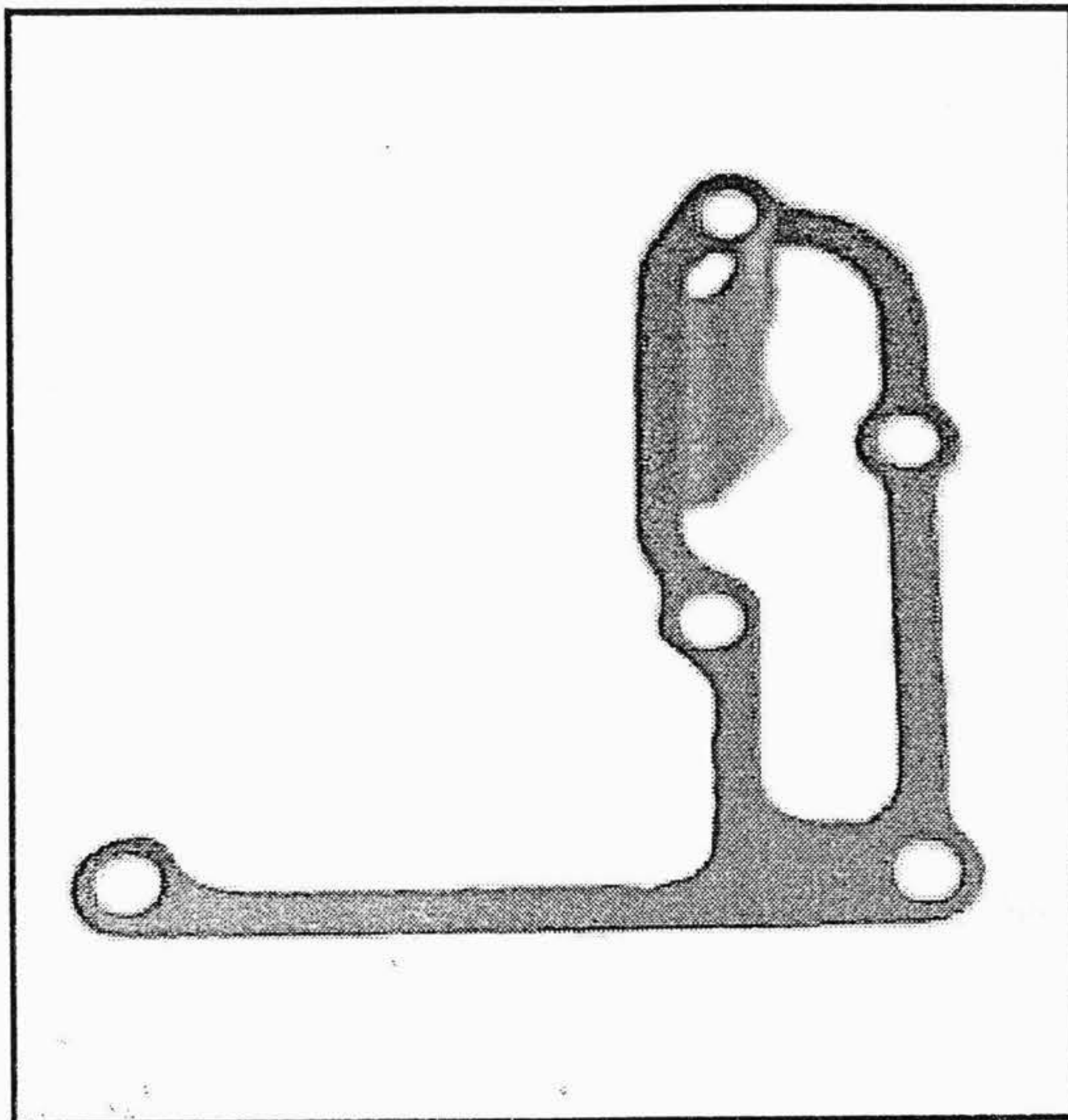

GUARNIZIONE IN METALLO PER METALLIC GASKET FOR

Pompa acqua / Water Pump

241.940 353.200.56.01

Kit di riparazione / Repair Kit

242.230 352.200.45.04

LP 810 - LP 813 - 911 B

1217 S - 1419 C / CL / L / LS

1420 - 1420 L - 1617 - 1619 C

1620 - 2219 - 2219 CL - 2220 - 2222

Pompa acqua / Water Pump

241.975 366.200.59.01

Kit di riparazione / Repair Kit

242.249 366.200.08.04

814 - 914 - 1114 - 1314 - 1414 - 1614

817 - 917 - 1117 - 1317

1417 - OH 1417 - 1517 - 1617

1017 - 1120 - 1320 - 1320 S - 1324

1419 C / CL / L / LS - 1520 - 1524

1617 - 1619 - 1620 - 1720 NAW

2219 - 2220 - 2222

OM 352.985

OM 362

OM 362 LA

OM 366

OM 366 A

OM 366 LA

Pompa acqua / Water Pump

241.985 366.200.60.01

Kit di riparazione / Repair Kit

242.249 366.200.08.04

817 - 917 - 1117 - 1317

1120 - 1320 - 1320 - 1520 - 1720 - 1820

OM 366 LA EURO II

241.878

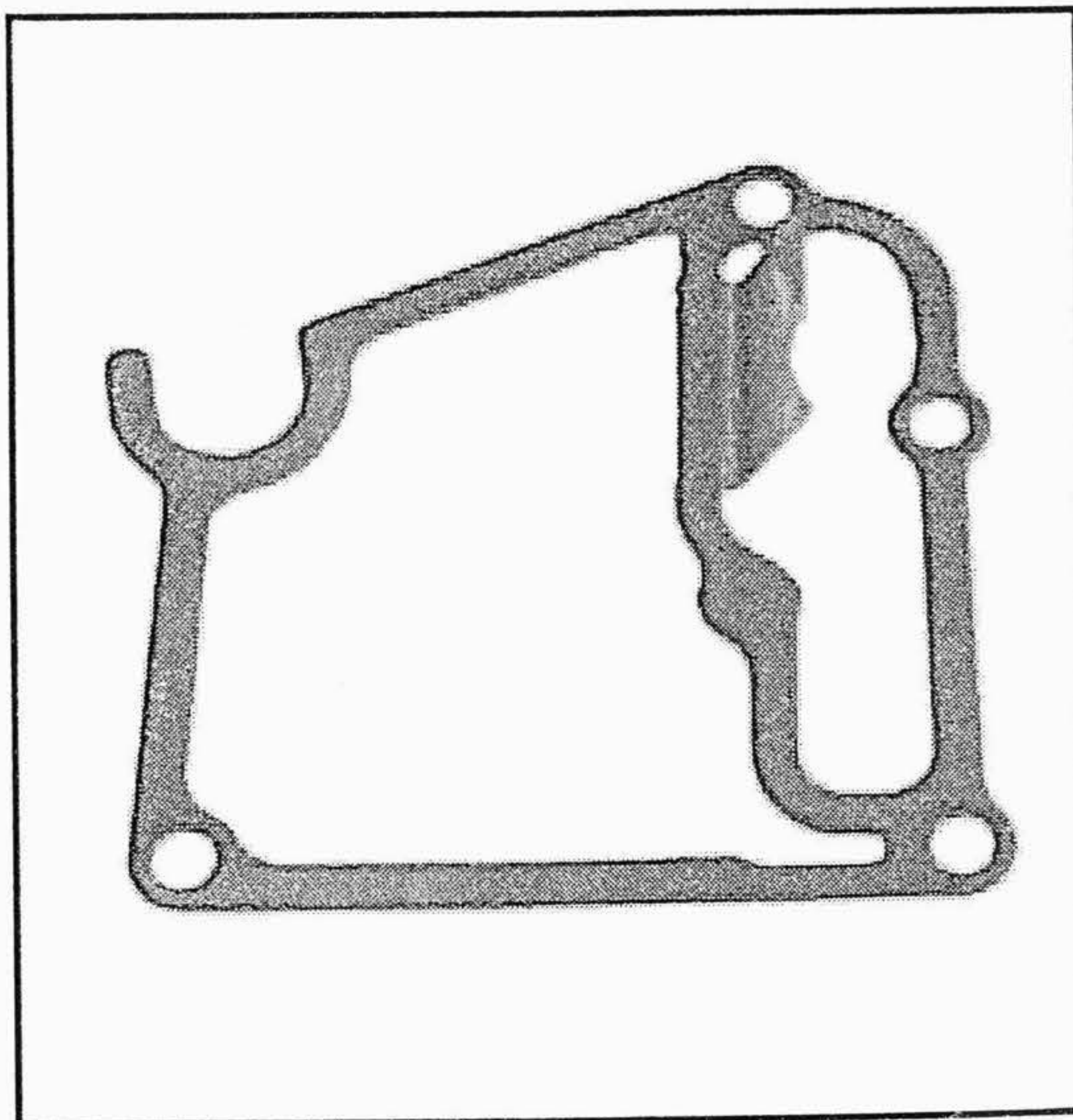

366.201.01.80



I ricambi non sono originali ma adattabili . Ogni riferimento originale é assolutamente indicativo .
Spare parts are not original but perfectly suitable . Every original part number has to be considered for reference purpose only .

SUITABLE

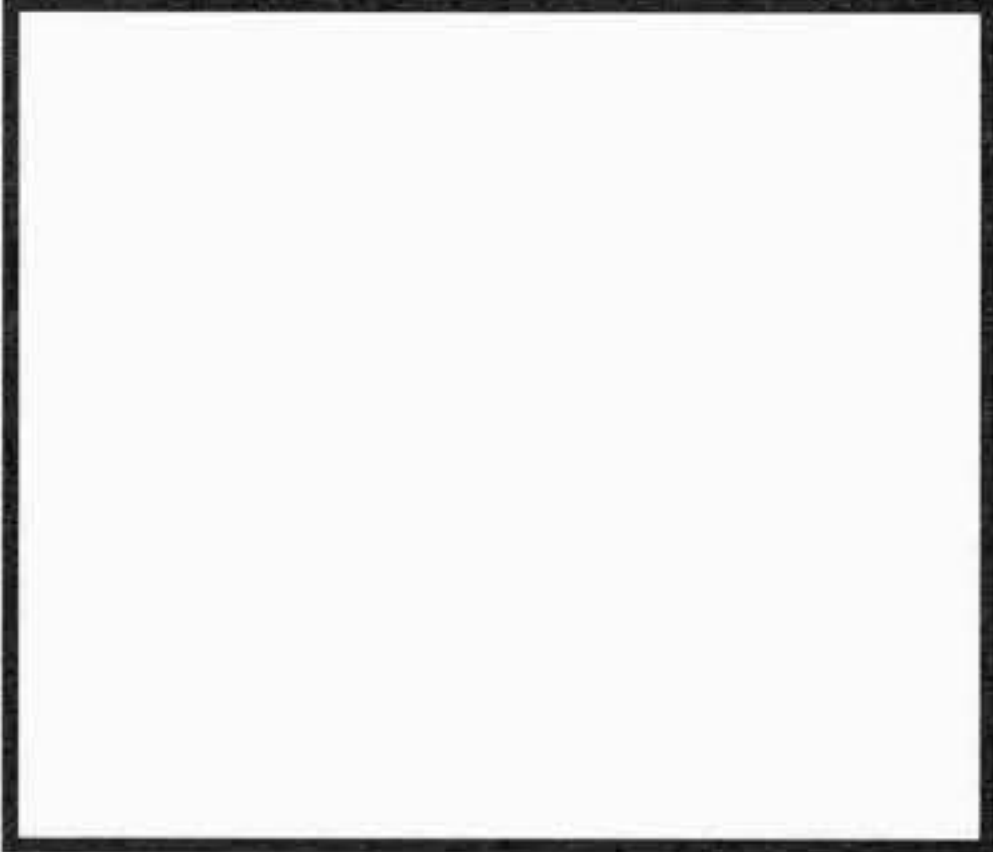
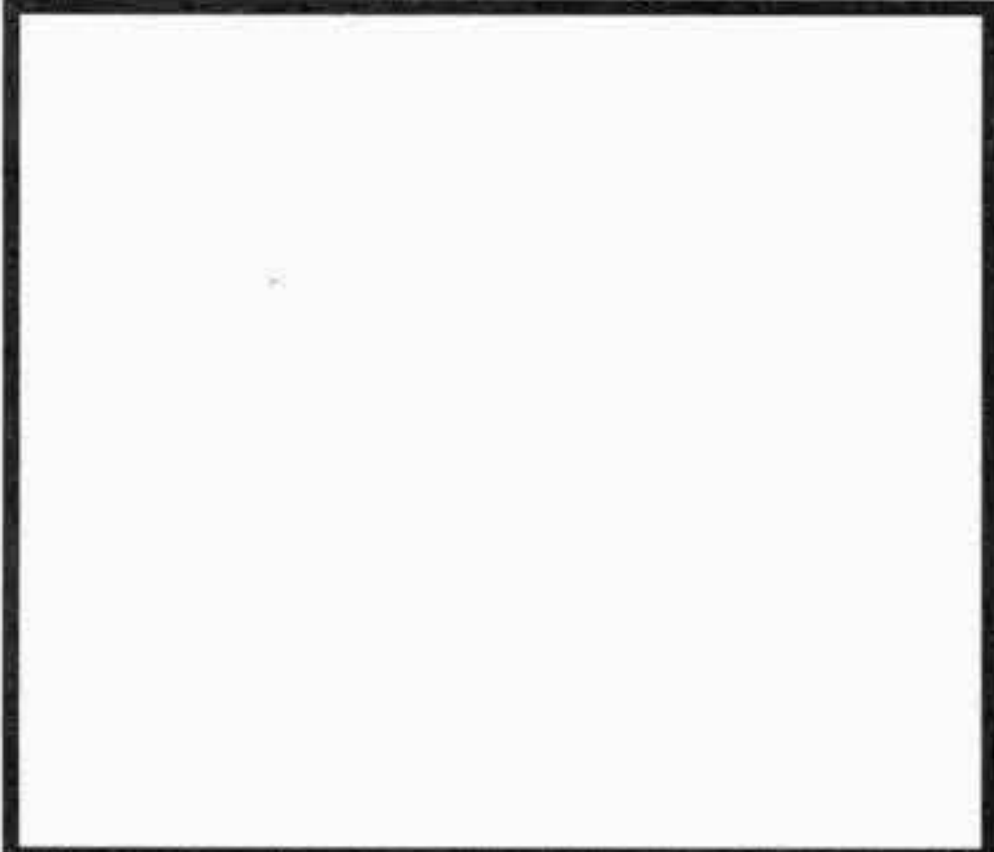
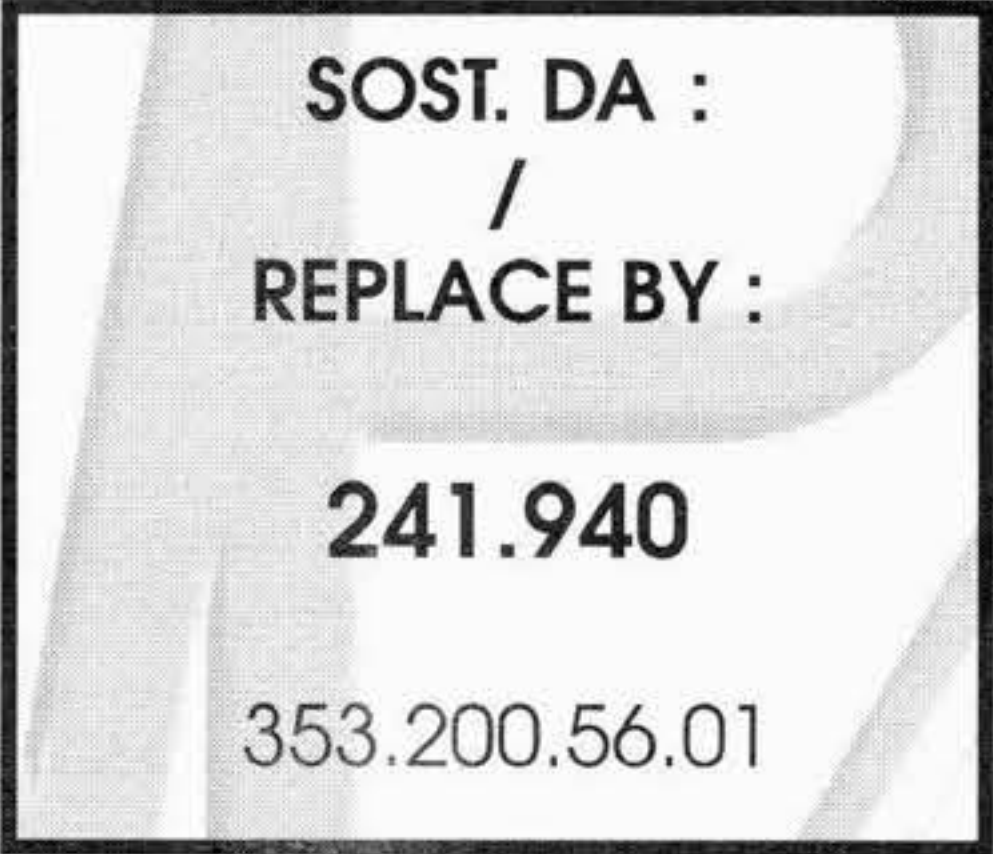
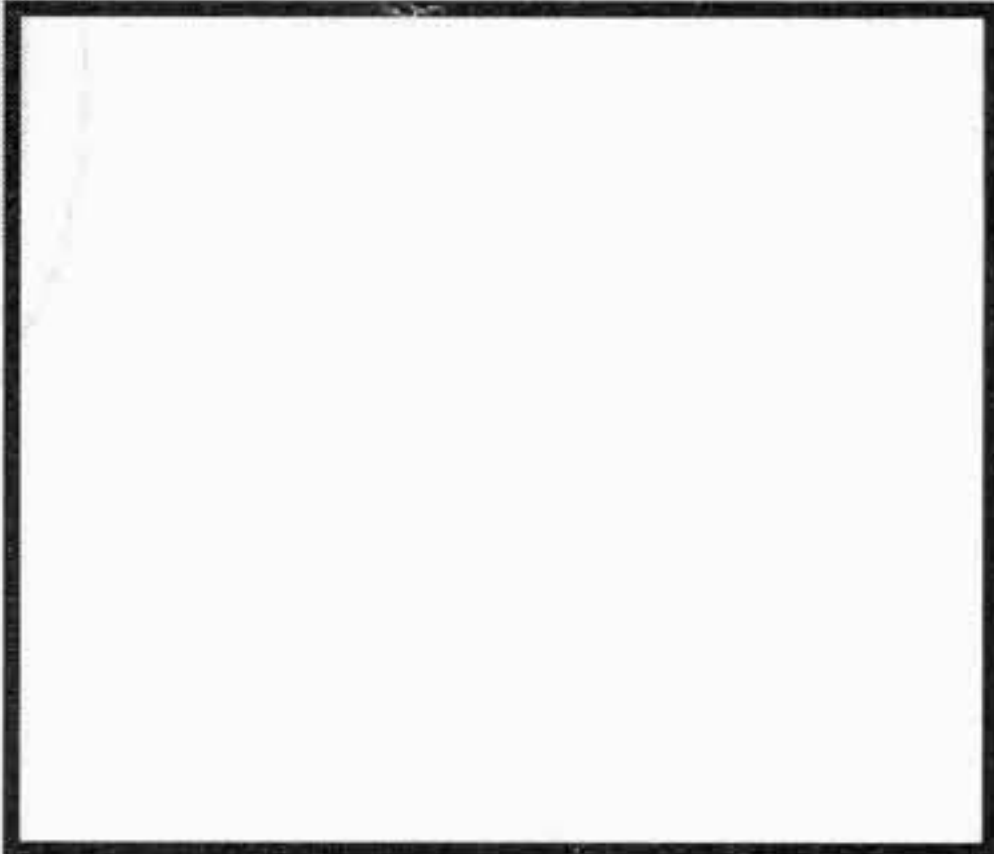
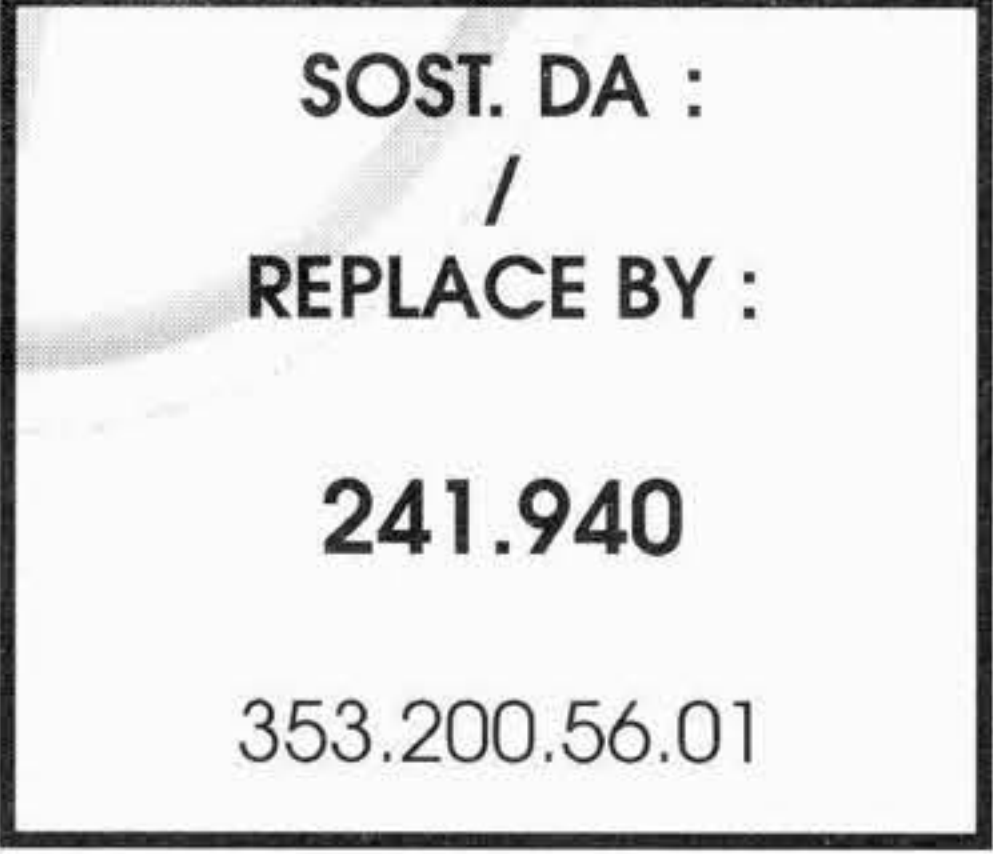
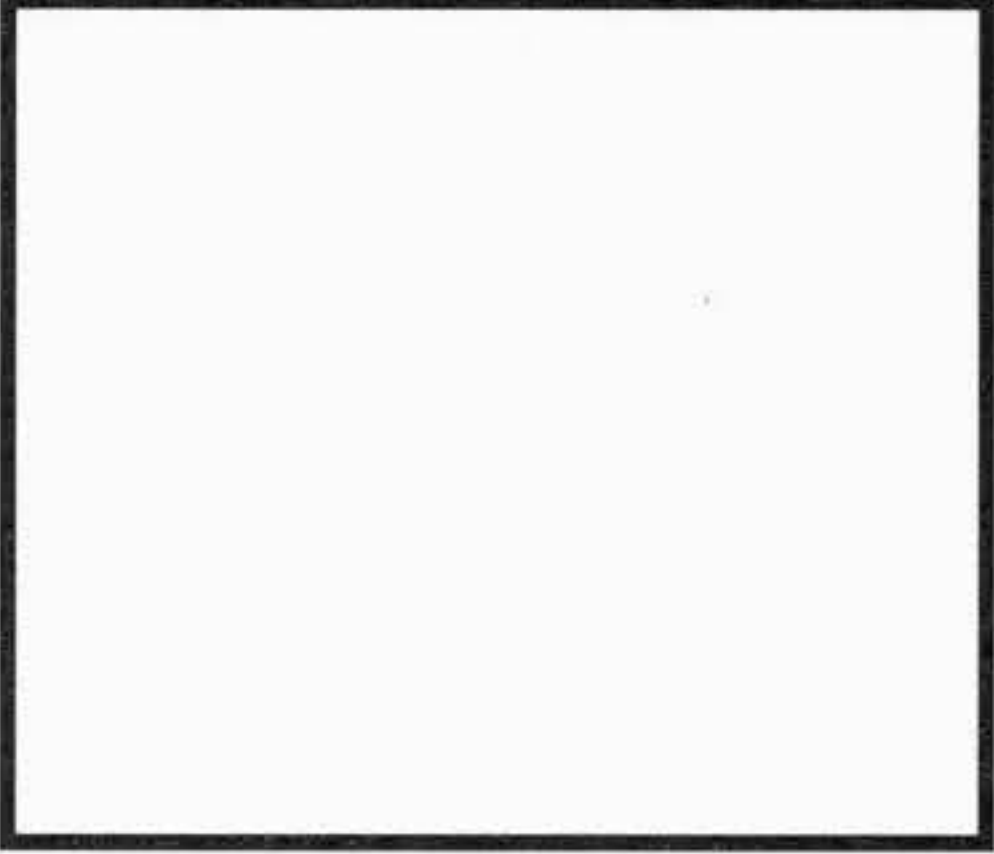
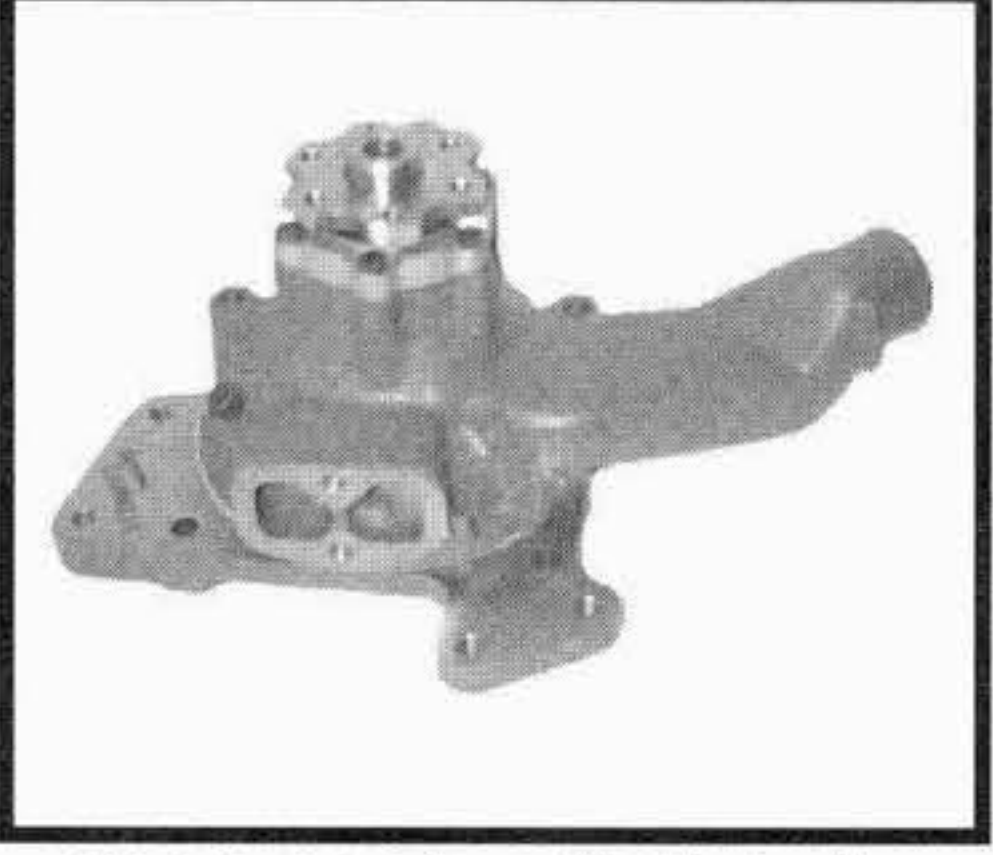
MERCEDES BENZ AUTOBUS - AUTOCARS - BUSES**Tel:+44(0)1925 850082 Fax: +(0)44 1925 850083****www.spwaterpumps.co.uk**

TIPO O MODELLO TYPE OU MODELE TYPE OR MODEL	MOTORE MOTEUR ENGINE	POMPA ACQUA POMPE A EAU WATER PUMP OMP REF. / O.EM. REF	KIT RIPARAZIONE NECESSAIRE DE REP. REPAIR KIT OMP REF. / O.EM. REF
O 317	OM 326 OM 346 H	241.845 346.200.10.01  girante / impeller Ø 90 mm	242.074 346.200.00.04 
O 302 O 309 D	OM 352 BM 352 --> mot. 049763 BM 353 --> mot. 441885 OM 352 --> mot. 441885	--- 352.200.95.01  SOST. DA : / REPLACE BY : 241.940 353.200.56.01 albero senza foro filettato / shaft without threaded bore girante / impeller Ø 87 mm	242.205 352.200.39.04 
O 302 O 309 D	OM 352 BM 352 mot. 049764 --> BM 353 mot. 441886 --> OM 352 mot. 441886 -->	--- 352.200.96.01  SOST. DA : / REPLACE BY : 241.940 353.200.56.01 albero senza foro filettato / shaft without threaded bore girante / impeller Ø 95 mm	242.164 352.200.41.04 
O 302 O 309 D	OM 352 BM 352 BM 353 OM 352	241.940 353.200.56.01  albero con foro filettato / shaft with threaded bore girante / impeller Ø 95 mm	242.230 352.200.45.04 

I ricambi non sono originali ma adattabili . Ogni riferimento originale é assolutamente indicativo .
Spare parts are not original but perfectly suitable . Every original part number has to be considered for reference purpose only .





SUITABLE

MERCEDES BENZ AUTOBUS - AUTOCARS - BUSES

Tel:+44(0)1925 850082 Fax: +(0)44 1925 850083

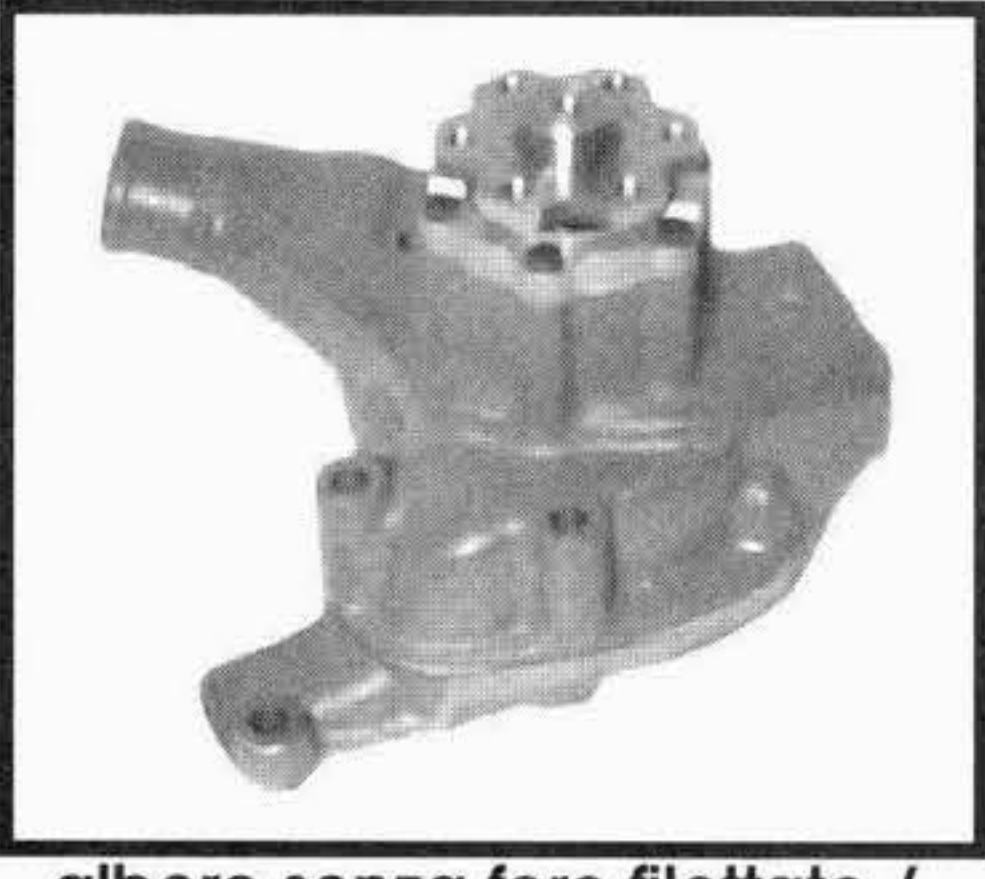
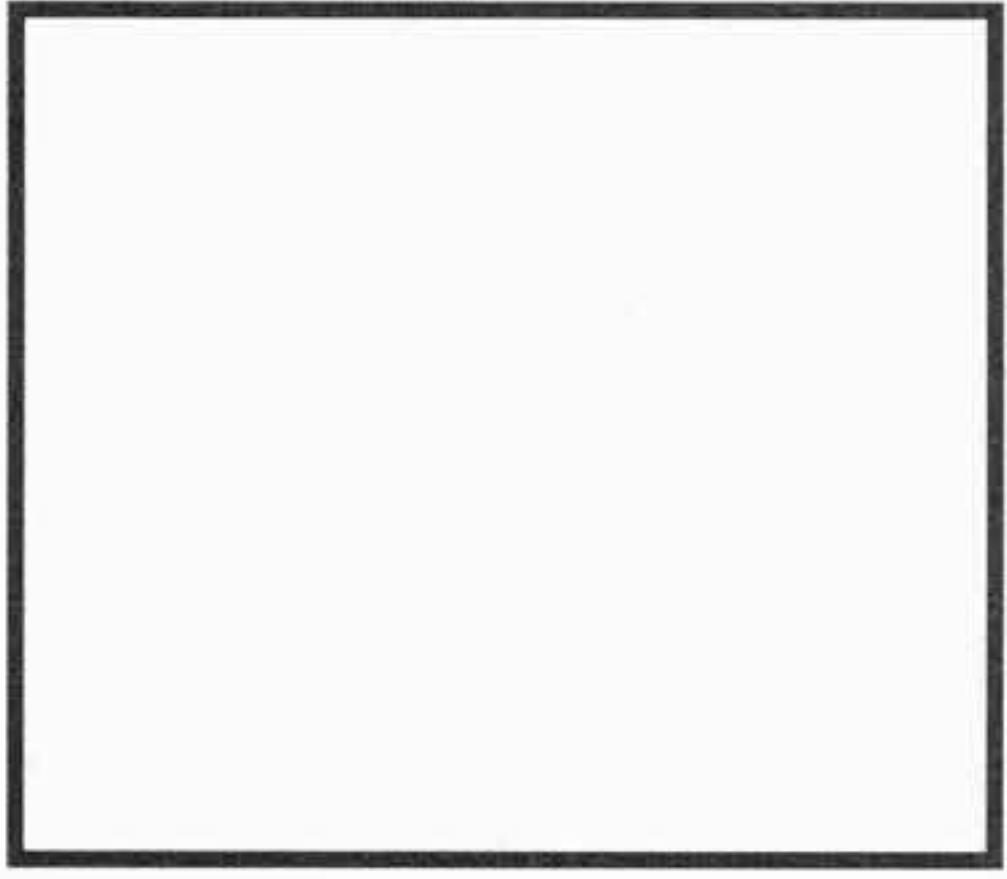
www.spwaterpumps.co.uk

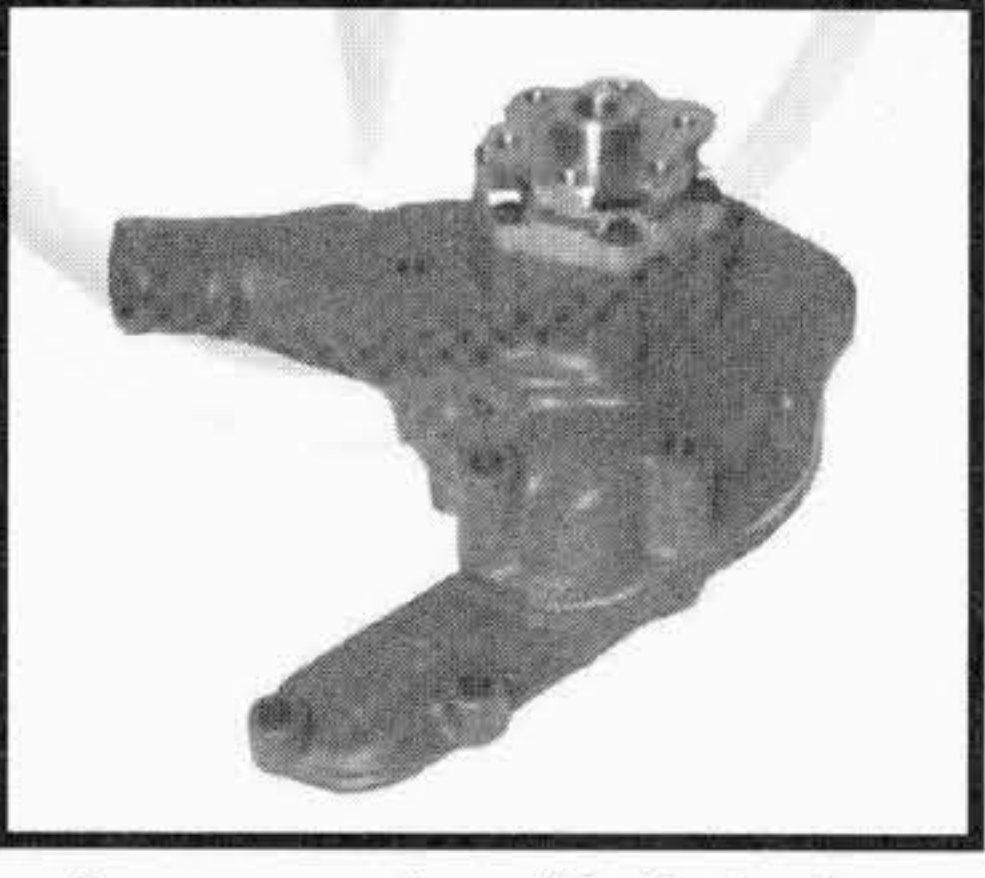

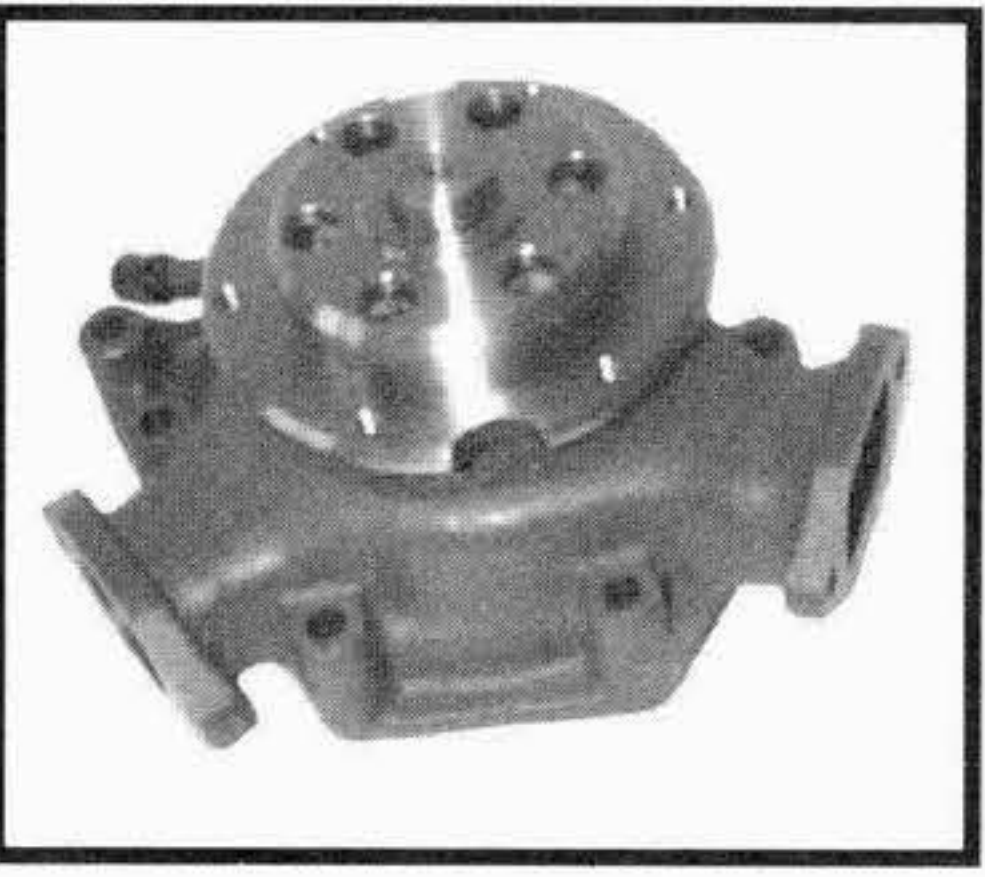
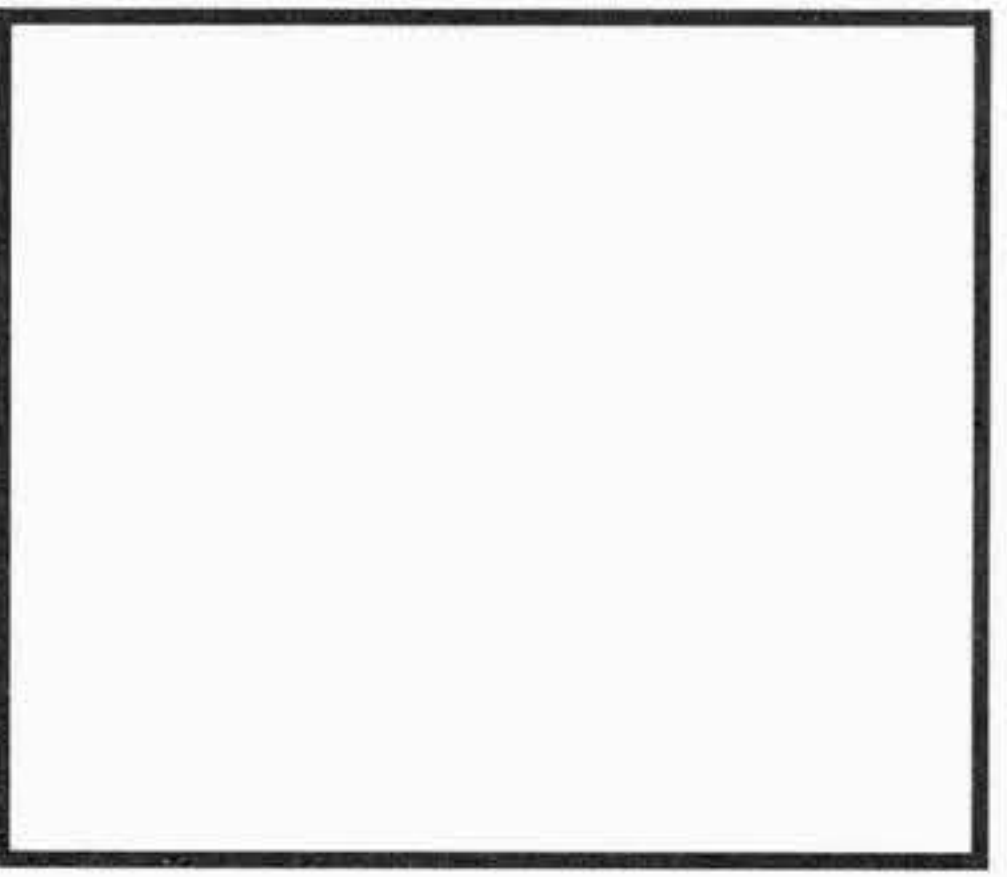
TIPO O MODELLO TYPE OU MODELE TYPE OR MODEL	MOTORE MOTEUR ENGINE	POMPA ACQUA POMPE A EAU WATER PUMP OMP REF. / O.EM. REF	KIT RIPARAZIONE NECESSAIRE DE REP. REPAIR KIT OMP REF. / O.EM. REF
O 321 H O 321 HL O 322	OM 352 --> mot. 034435	<p>241.790 353.200.40.01</p>  <p>albero senza foro filettato / shaft without threaded bore girante / impeller Ø 87 mm</p>	<p>242.191 352.200.38.04</p> 
O 321 H O 321 HL O 322	OM 352 mot. 034436 -->	<p>--- 353.200.36.01</p> <div style="border: 1px solid black; padding: 5px; text-align: center;"> <p>SOST. DA : / REPLACE BY :</p> <p>241.935</p> <p>353.200.37.01</p> </div> <p>albero con foro filettato / shaft with threaded bore girante / impeller Ø 95 mm</p>	<p>242.229 352.200.44.04</p> 
O 321 H O 321 HL O 322	OM 352	<p>241.935 353.200.37.01</p>  <p>albero con foro filettato / shaft with threaded bore girante / impeller Ø 95 mm</p>	<p>242.229 352.200.44.04</p> 
O 302 MEXICO O 302 O 322 YUGOSLAVIA	OM 355 A OM 355	<p>241.800 355.200.08.01</p>  <p>girante / impeller Ø 115 mm</p>	<p>242.076 355.200.13.04</p> 

I ricambi non sono originali ma adattabili . Ogni riferimento originale é assolutamente indicativo .
Spare parts are not original but perfectly suitable . Every original part number has to be considered for reference purpose only .







SUITABLE

MERCEDES BENZ AUTOBUS - AUTOCARS - BUSES

Tel: +44(0)1925 850082 Fax: +(0)44 1925 850083

www.spwaterpumps.co.uk

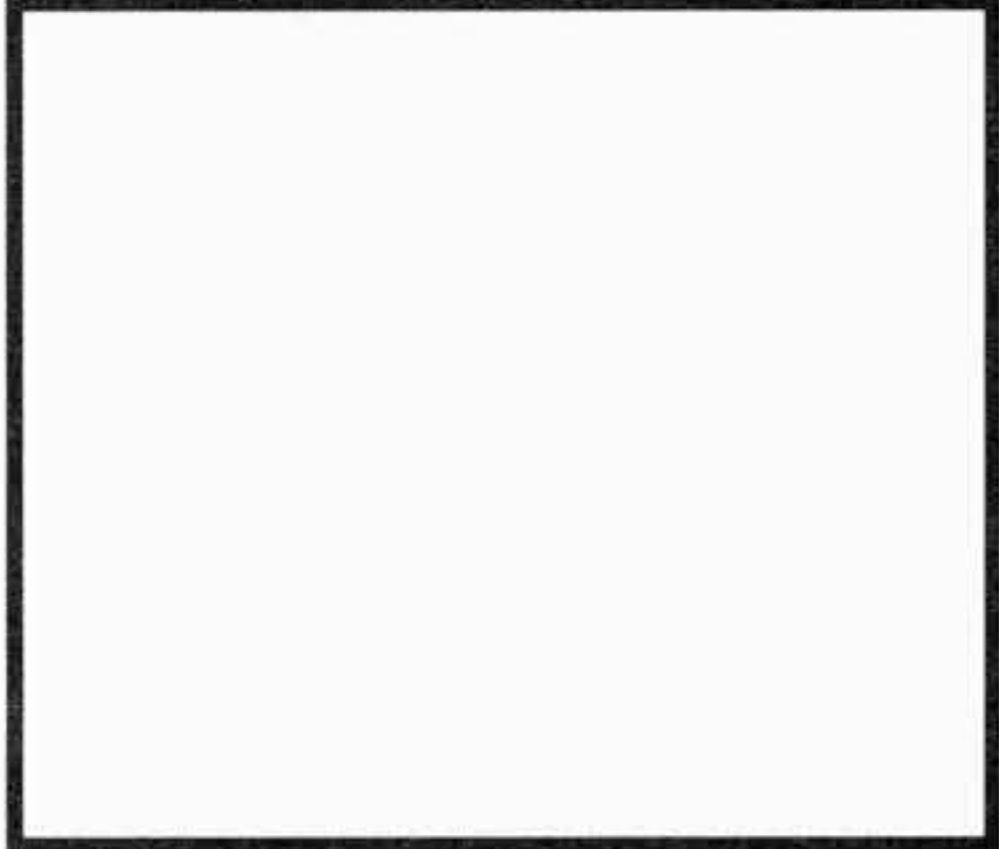

TIPO O MODELLO TYPE OU MODELE TYPE OR MODEL	MOTORE MOTEUR ENGINE	POMPA ACQUA POMPE A EAU WATER PUMP OMP REF. / O.EM. REF	KIT RIPARAZIONE NECESSAIRE DE REP. REPAIR KIT OMP REF. / O.EM. REF
O 302 MEXICO O 302 O 322 YUGOSLAVIA	OM 355 A OM 355	<p>241.890 355.200.09.01</p>  <p>girante / impeller Ø 120 mm</p>	<p>242.161 355.200.14.04</p> 
O 302 MEXICO O 302 O 322 YUGOSLAVIA	OM 355 A OM 355	<p>241.905 355.200.15.01</p>  <p>con albero cuscinetto / with shaft bearing girante / impeller Ø 120 mm</p>	<p>242.212 355.200.12.04</p> 
O 317	OM 355 H	<p>241.760 355.200.00.01</p> 	<p>242.074 355.200.05.04</p> 
O 355 O 364	OM 355 BRAZIL	<p>241.955 345.200.71.01</p>  <p>con albero cuscinetto / with shaft bearing girante / impeller Ø 120 mm</p>	<p>242.161 355.200.14.04</p> 



I ricambi non sono originali ma adattabili . Ogni riferimento originale é assolutamente indicativo .
 Spare parts are not original but perfectly suitable . Every original part number has to be considered for reference purpose only .

MERCEDES BENZ AUTOBUS - AUTOCARS - BUSES

Tel: +44(0)1925 850082 Fax: +(0)44 1925 850083

www.spwaterpumps.co.uk

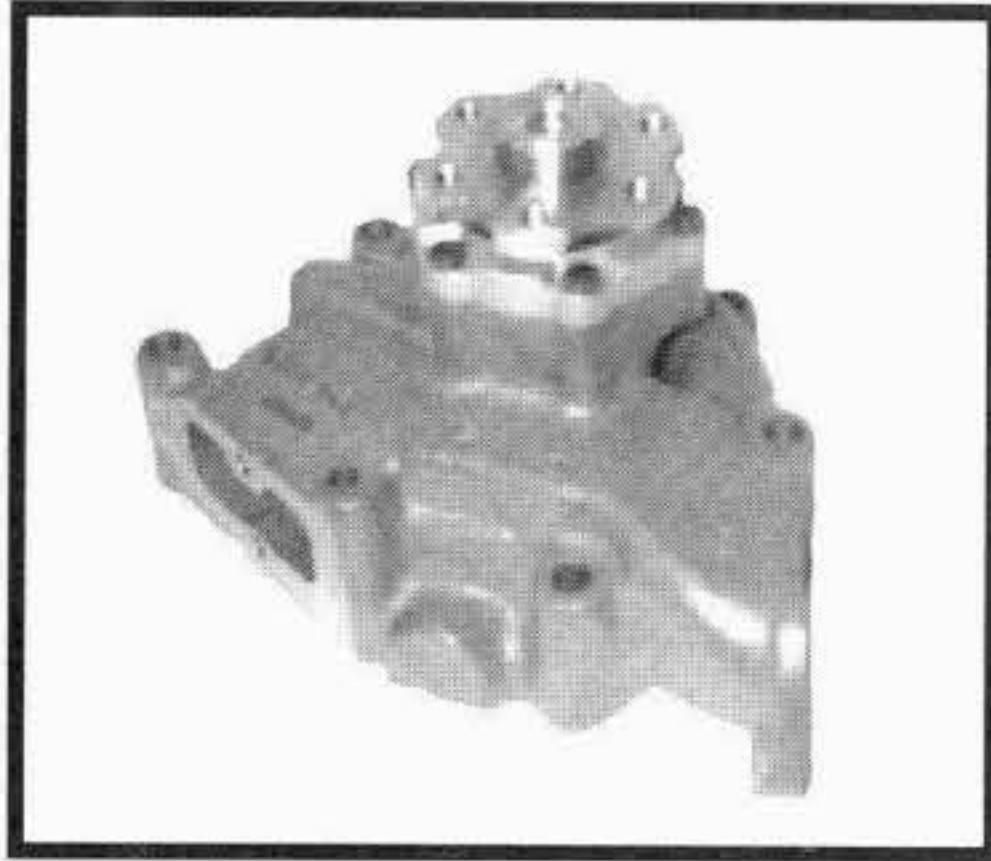
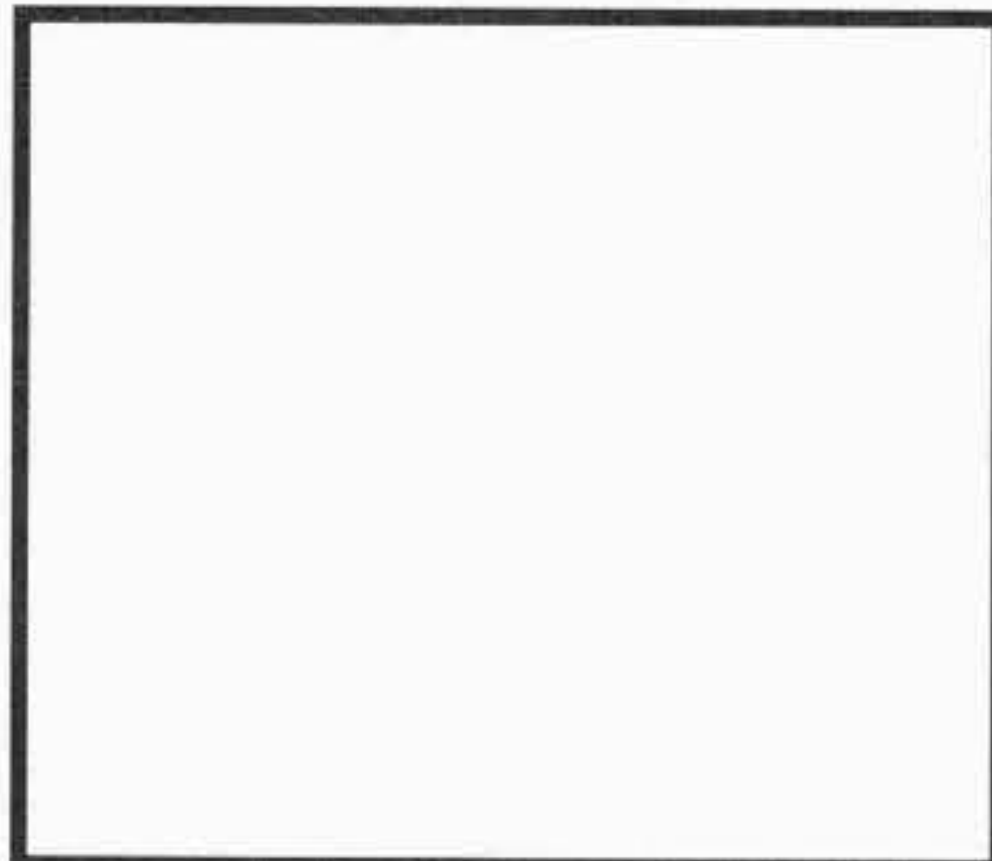
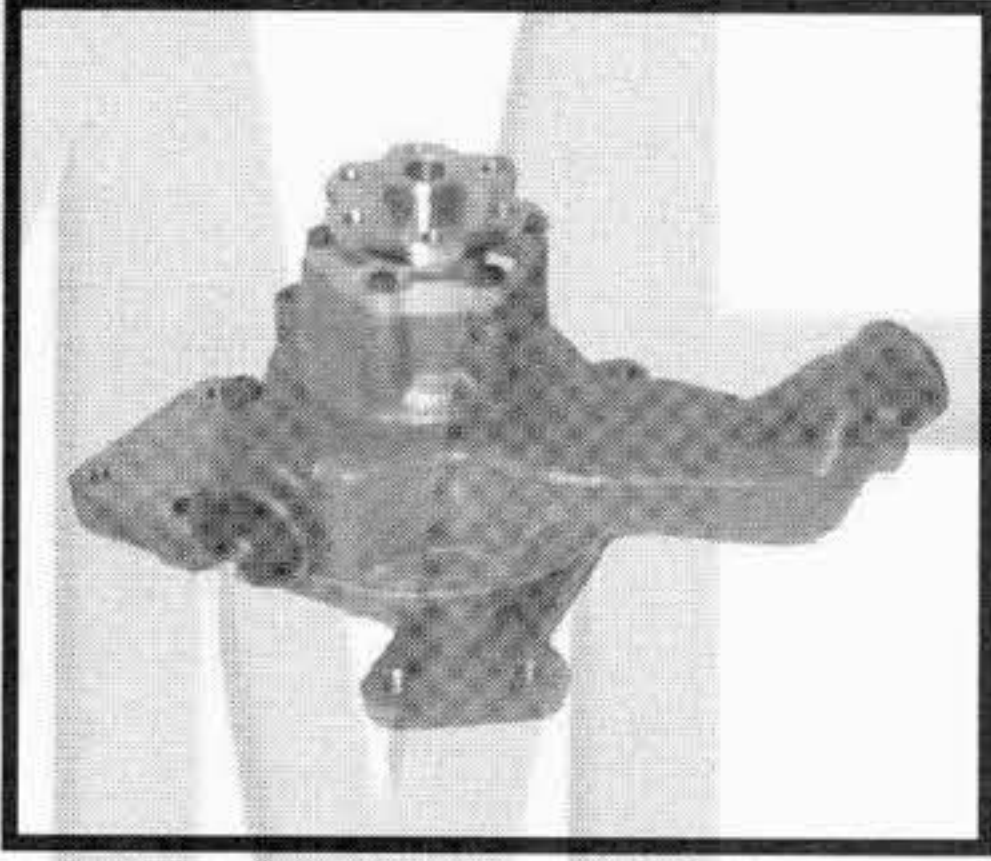
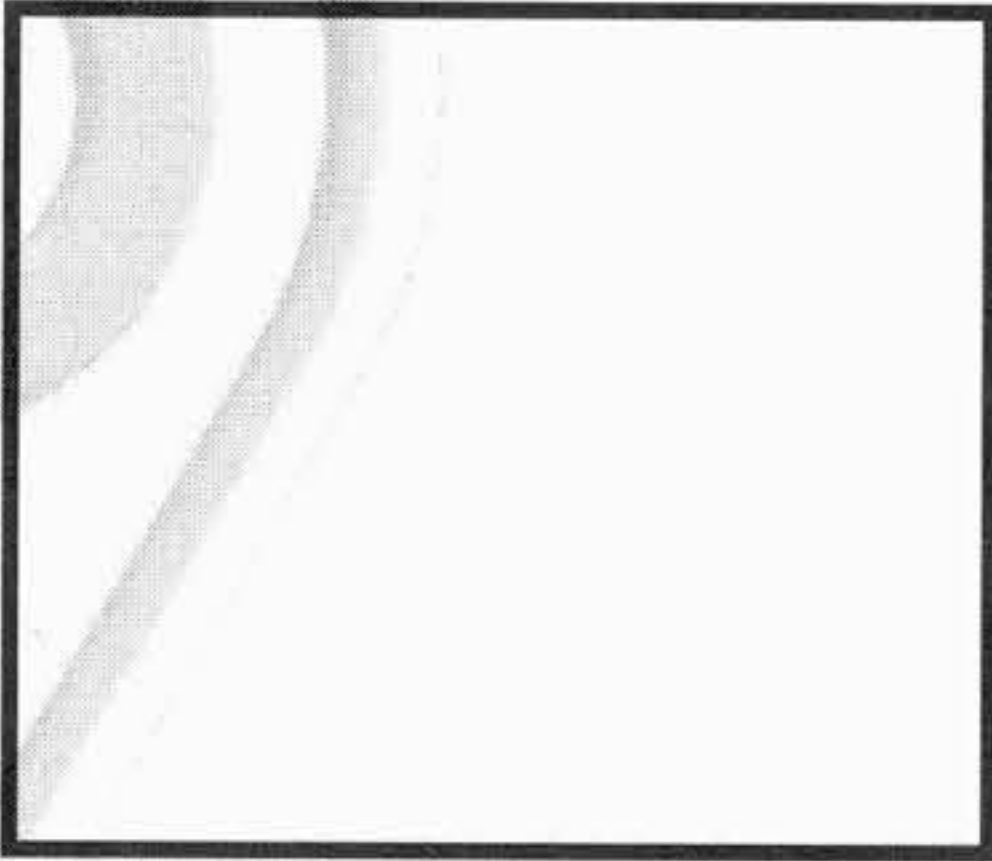

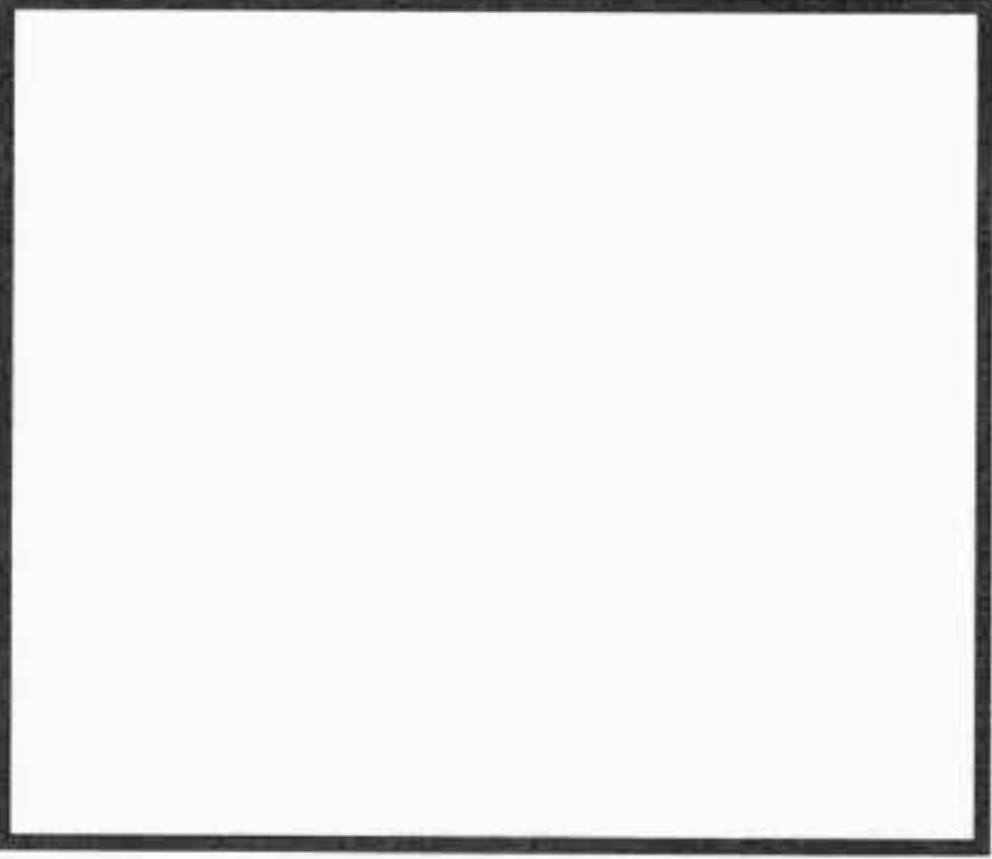
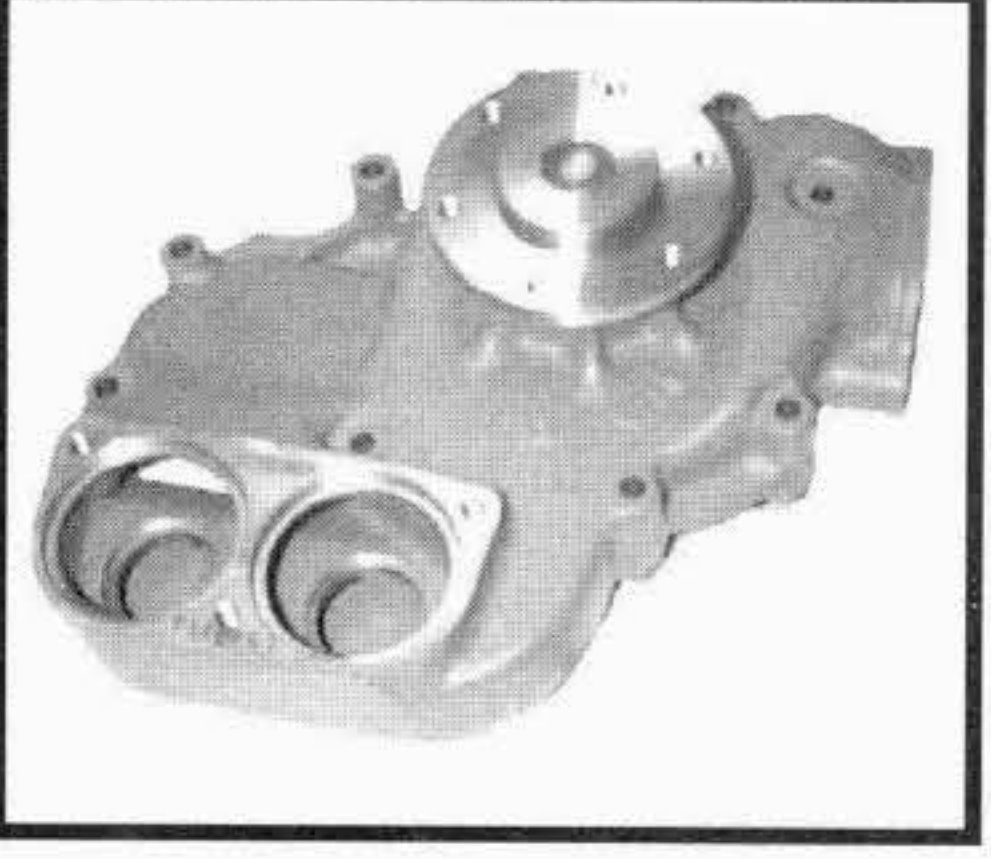
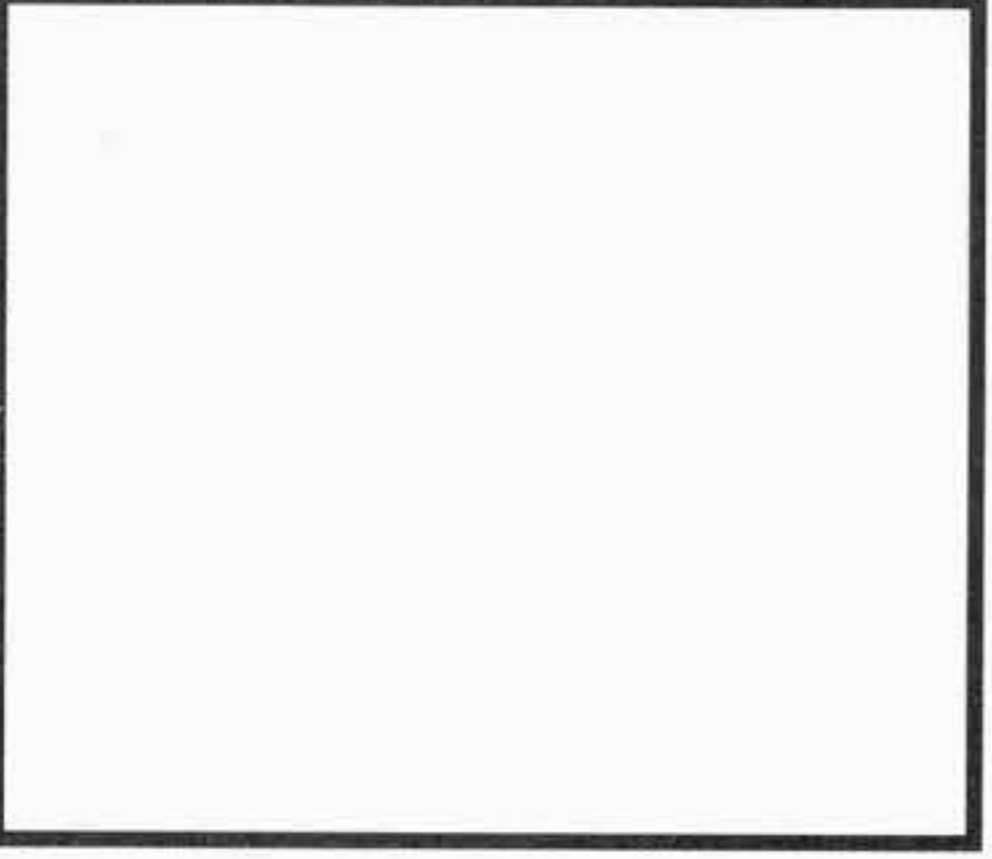
TIPO O MODELLO TYPE OU MODELE TYPE OR MODEL	MOTORE MOTEUR ENGINE	POMPA ACQUA POMPE A EAU WATER PUMP OMP REF. / O.EM. REF	KIT RIPARAZIONE NECESSAIRE DE REP. REPAIR KIT OMP REF. / O.EM. REF
O 302 O 305	OM 360	241.740 360.200.46.01  albero con foro filettato / shaft with threaded bore	242.058 360.200.07.04 
O 301 O 402	OM 366 OM 366 A OM 366 OM 366 A	241.975 366.200.59.01  albero con foro filettato / shaft with threaded bore girante / impeller Ø 95 mm	242.249 366.200.08.04 
O 303 O 303 O 303 O 305 - O 305 G - O 307	OM 401 --> mot. 129660 OM 402 --> mot. 129660 OM 403 --> mot. 129660 OM 407 H 905/908/909/910/911 913/914/915/916/918 --> mot. 017497	241.825 403.200.70.01  note : girante / impeller Ø 125 mm	242.181 422.200.03.04 
O 303 O 303 O 303 O 303 O 303 O 305 - O 305 G - O 307 O 303 O 405 ST	OM 401 mot. 129661 -> OM 402 mot. 129661 -> OM 403 mot. 129661 -> OM 421 - 421 A OM 422 - 422A OM 407 H 905/908/909 910/911/913/914/915/916/918 mot. 017498 --> OM 441 - 441 A --> mot. 504397 OM 442 - 442 A OM 427 H.910	241.835 403.200.71.01  note : girante / impeller Ø 125 mm	242.181 422.200.03.04 

I ricambi non sono originali ma adattabili . Ogni riferimento originale é assolutamente indicativo .
Spare parts are not original but perfectly suitable . Every original part number has to be considered for reference purpose only .







SUITABLE

MERCEDES BENZ AUTOBUS - AUTOCARS - BUSES

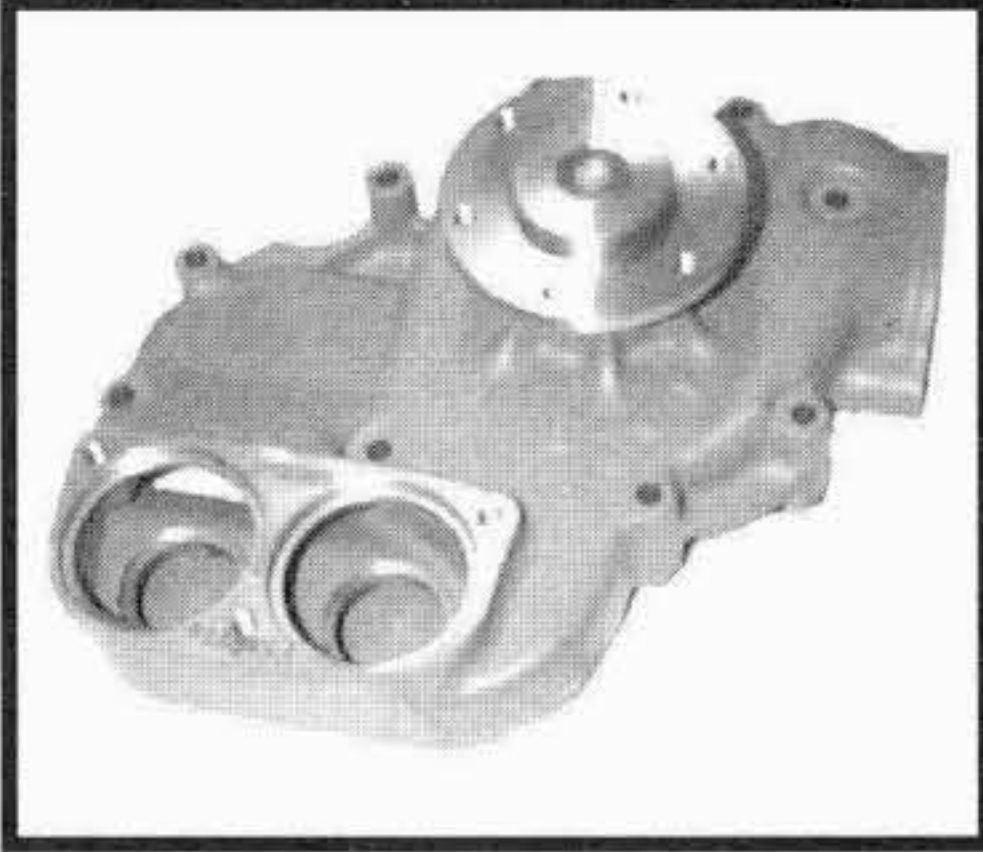
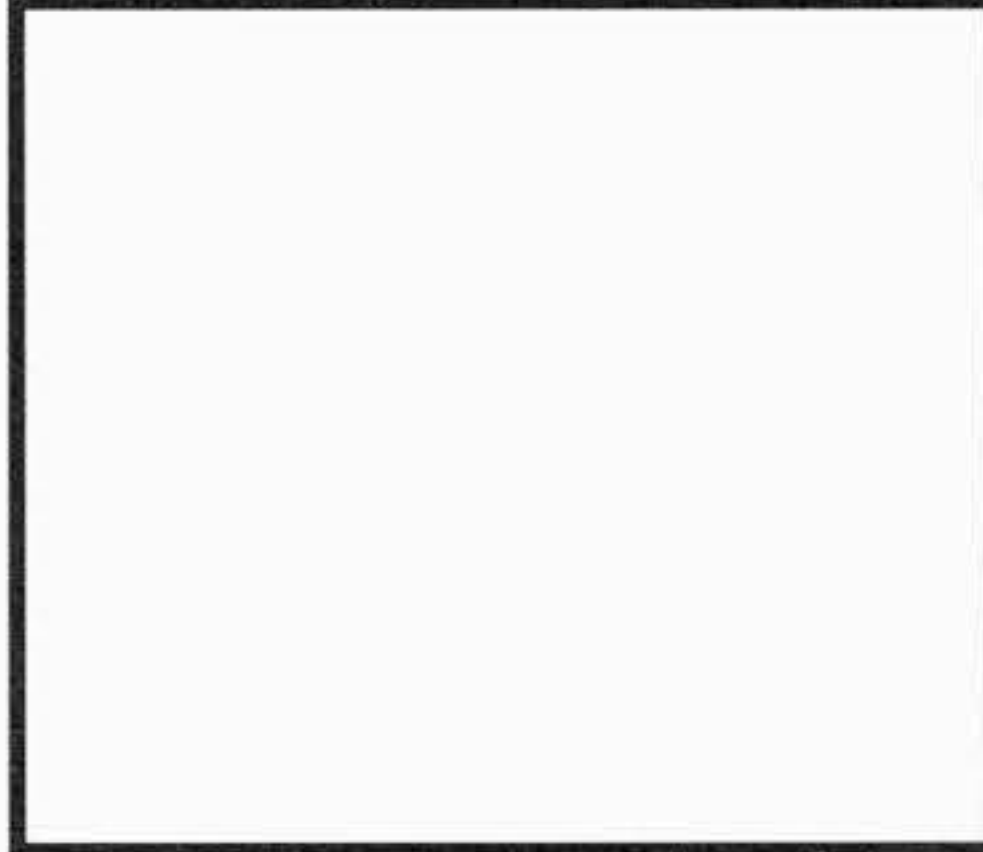
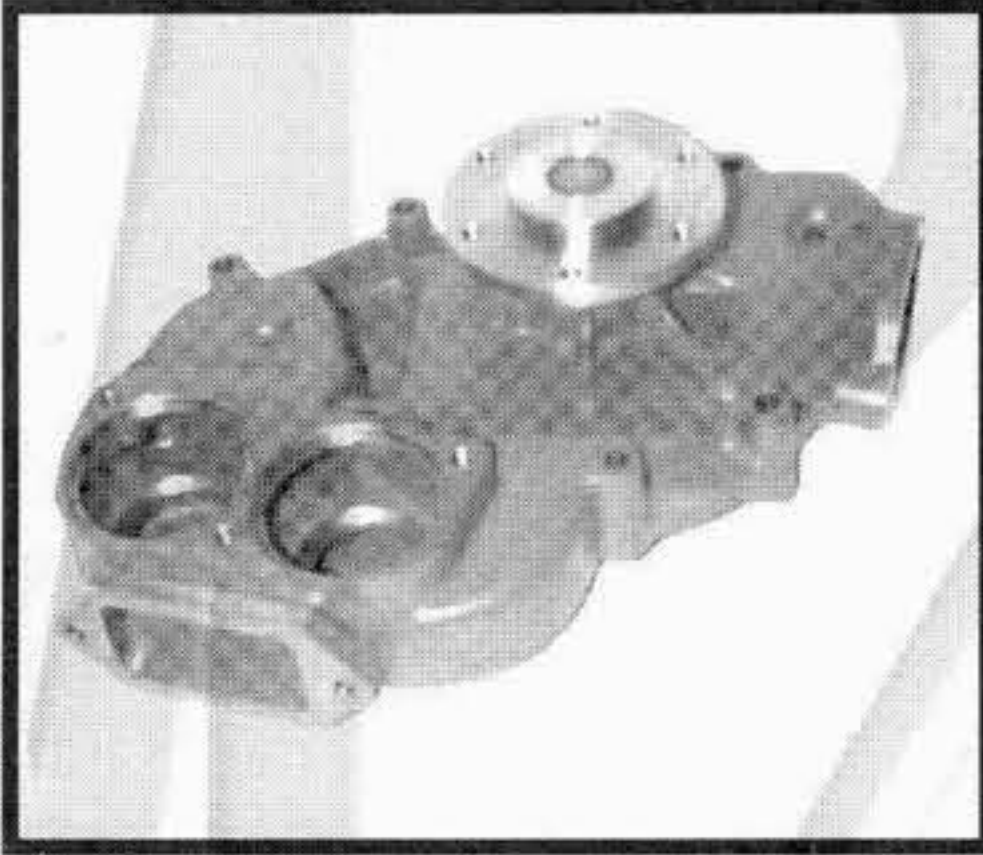
Tel: +44(0)1925 850082 Fax: +44(0)1925 850083

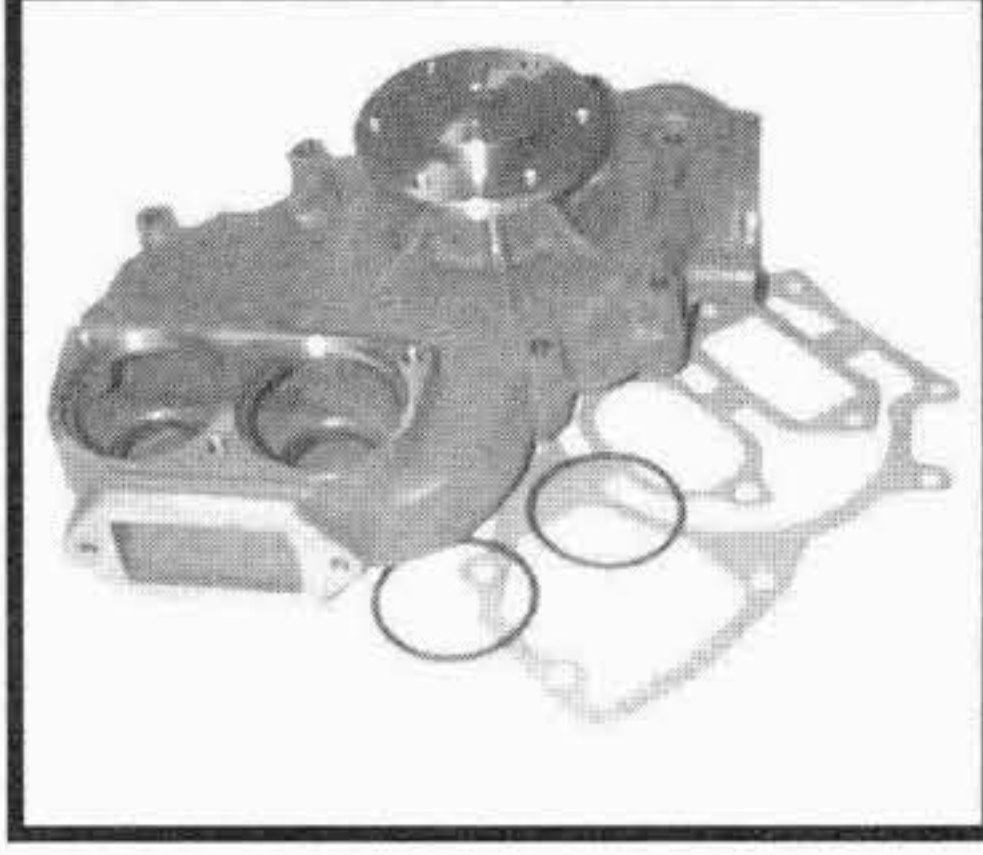

www.spwaterpumps.co.uk



TIPO O MODELLO TYPE OU MODELE TYPE OR MODEL	MOTORE MOTEUR ENGINE	POMPA ACQUA POMPE A EAU WATER PUMP OMP REF. / O.EM. REF	KIT RIPARAZIONE NECESSAIRE DE REP. REPAIR KIT OMP REF. / O.EM. REF
O 303	OM 441 - 441 A mot. 504398 --> OM 442 - 442 A	241.995 441.200.02.01 	242.265 441.200.01.04 
O 303 O 305 - O 305 G O 305 G O 307 AUTOBUS CON CAMBIO AUTOMATICO E RITARDATEUR AUTOCARS AVEC BOITE DE VITESSE AUTOMATIQUE ET RETARDATEUR BUSES WITH AUTOMATIC GEARBOX AND RETARDER	OM 401.901/.917 --> mot. 129660 OM 407 AH.955 OM 407 H.919 --> mot. 017497 OM 407 AH.955	241.840 403.200.72.01  note : girante / impeller Ø 125 mm	242.181 422.200.03.04 
O 303 O 303 O 305 G O 405 O 405 - O 405 G O 405 ST O 407 GTD - O 407 U AUTOBUS CON CAMBIO AUTOMATICO E RITARDATEUR AUTOCARS AVEC BOITE DE VITESSE AUTOMATIQUE ET RETARDATEUR BUSES WITH AUTOMATIC GEARBOX AND RETARDER	OM 401.901/.917 mot. 129661 --> OM 402.907 / 918 OM 421.908 OM 422.908 / 951 OM 407 AH.951 mot. 017498 --> OM 427 HA/.950 OM 447 H - HA OM 427 H - OM 447 H OM 447 H 14mm Hole	241.895 403.200.73.01  note : girante / impeller Ø 125 mm	242.181 422.200.03.04 
TUTTI I MODELLI ALL MODELS AUTOBUS CON CAMBIO AUTOMATICO E RITARDATEUR AUTOCARS AVEC BOITE DE VITESSE AUTOMATIQUE ET RETARDATEUR BUSES WITH AUTOMATIC GEARBOX AND RETARDER	OM 422 --> mot. 146024	241.970 422.200.11.01  note : girante / impeller Ø 135 mm	242.237 422.200.04.04 

I ricambi non sono originali ma adattabili . Ogni riferimento originale é assolutamente indicativo .

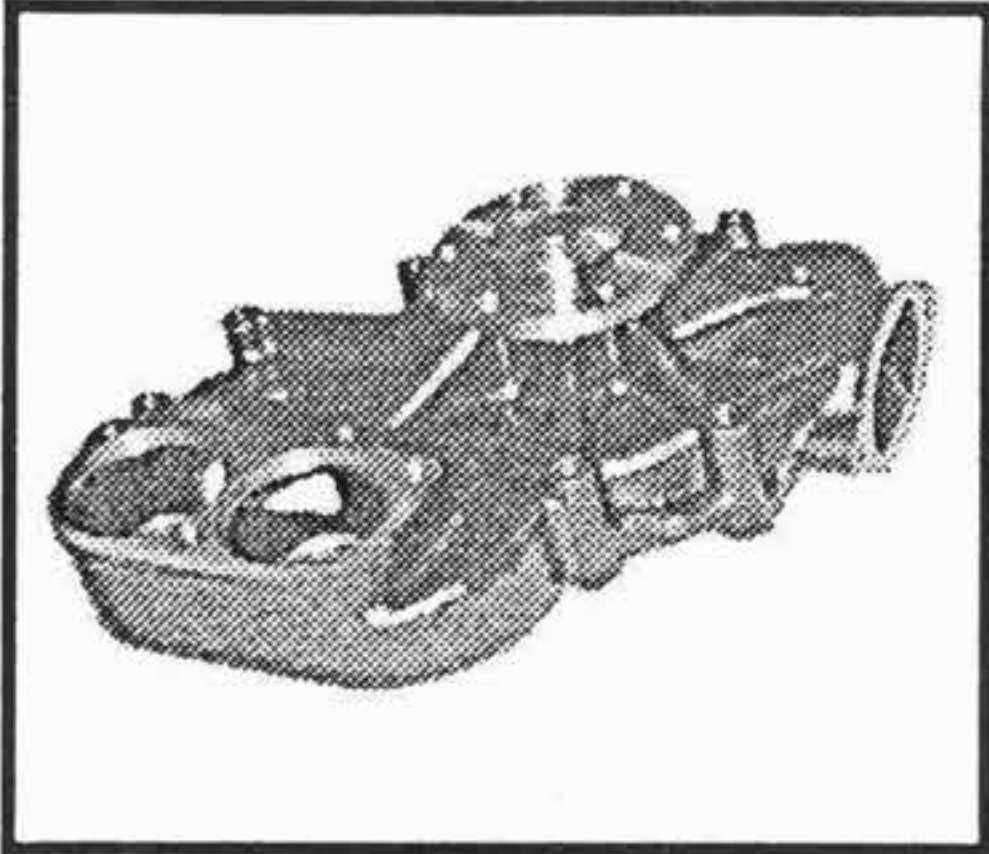
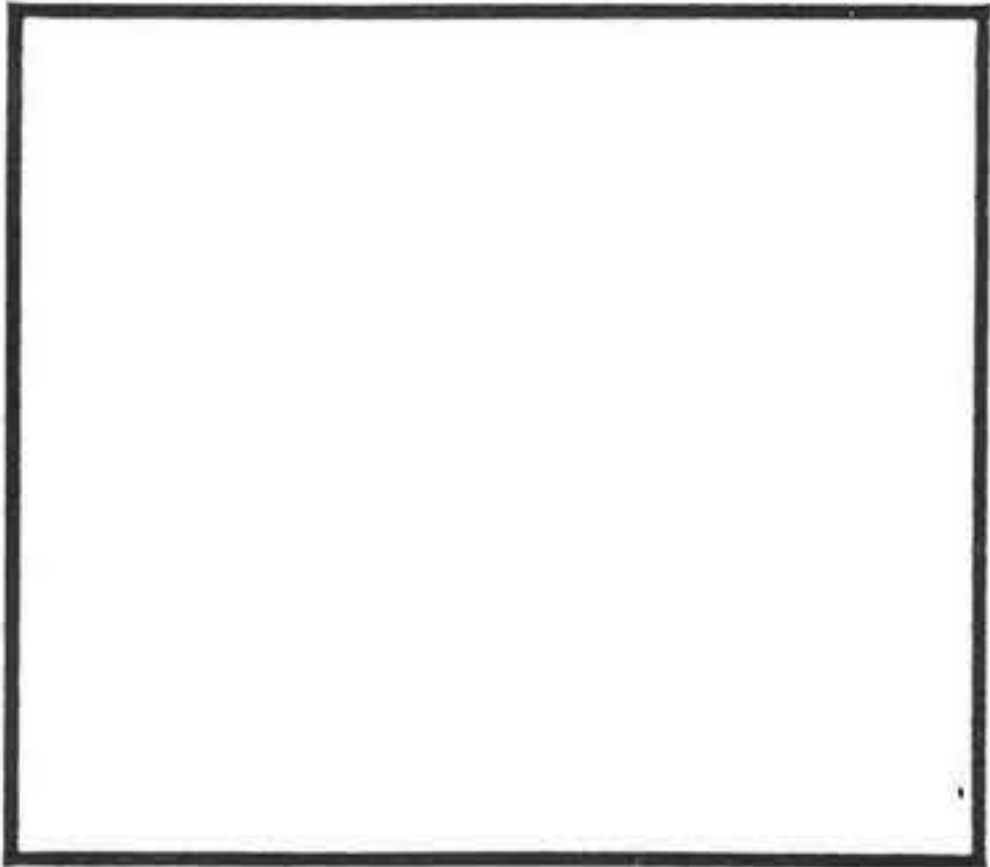
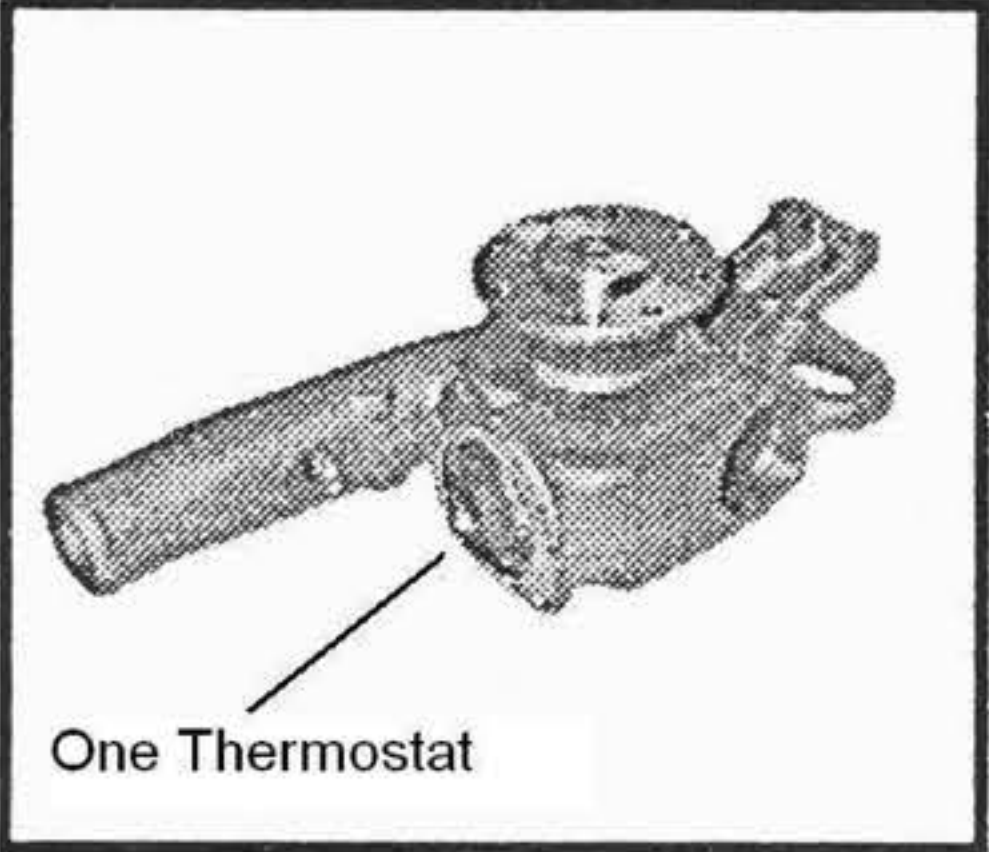
Spare parts are not original but perfectly suitable . Every original part number has to be considered for reference purpose only .

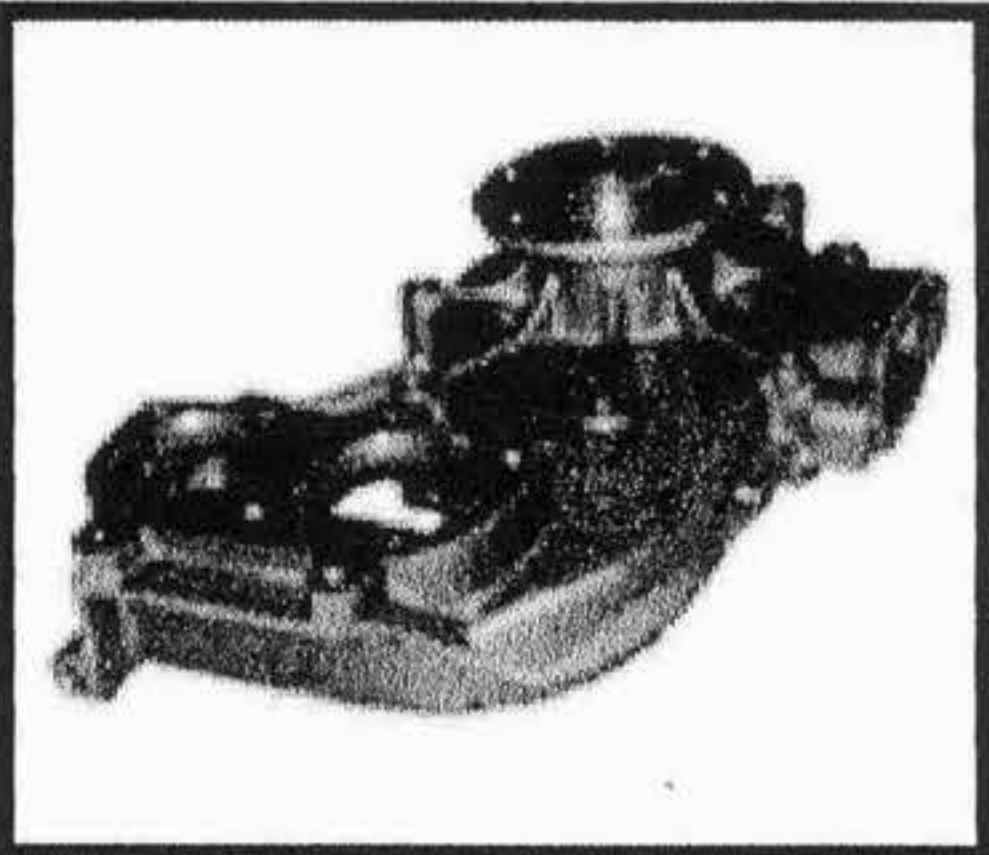
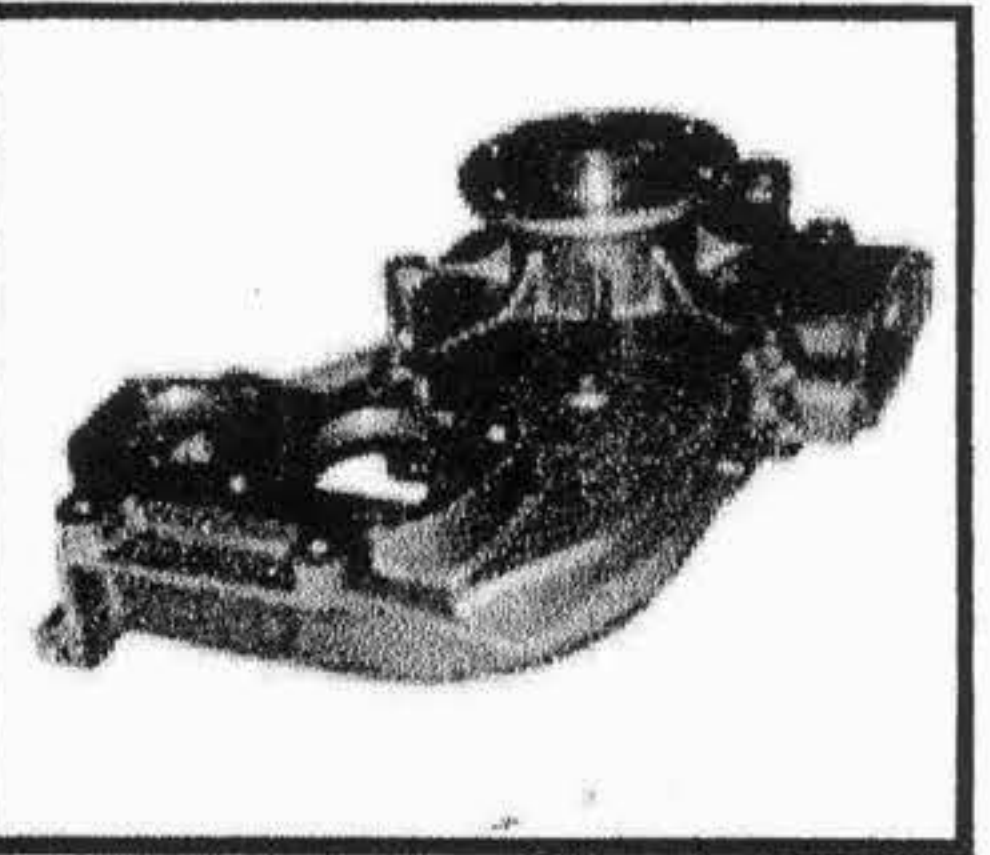
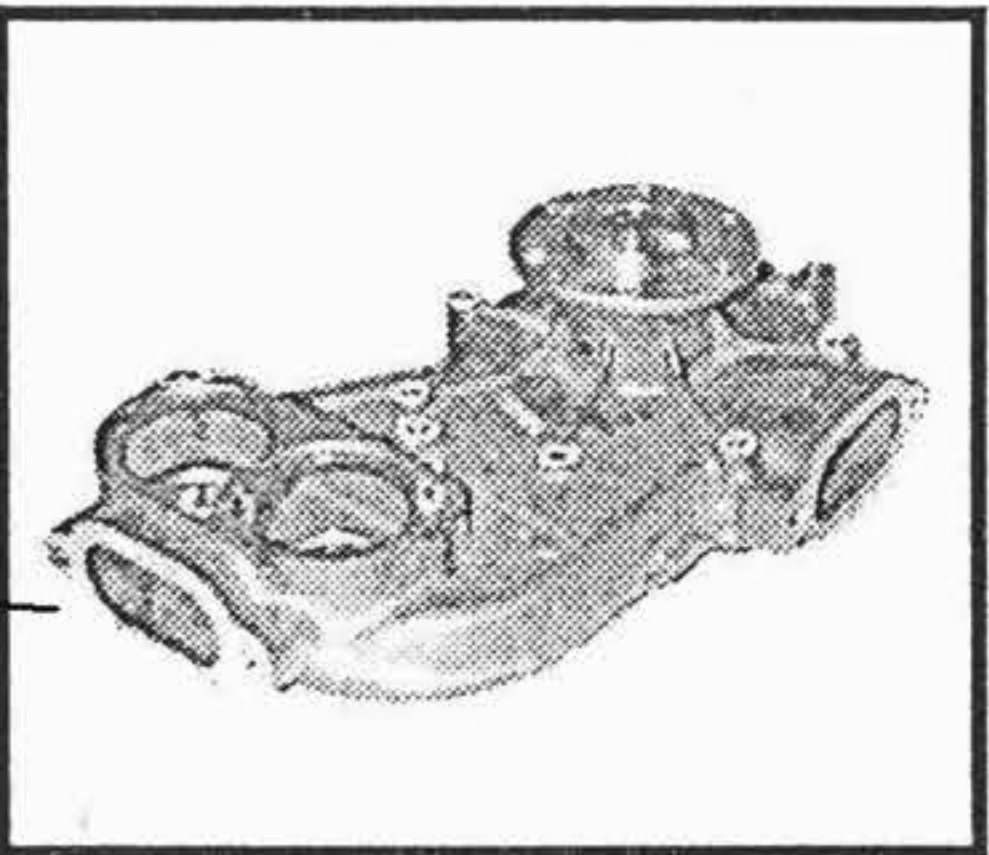
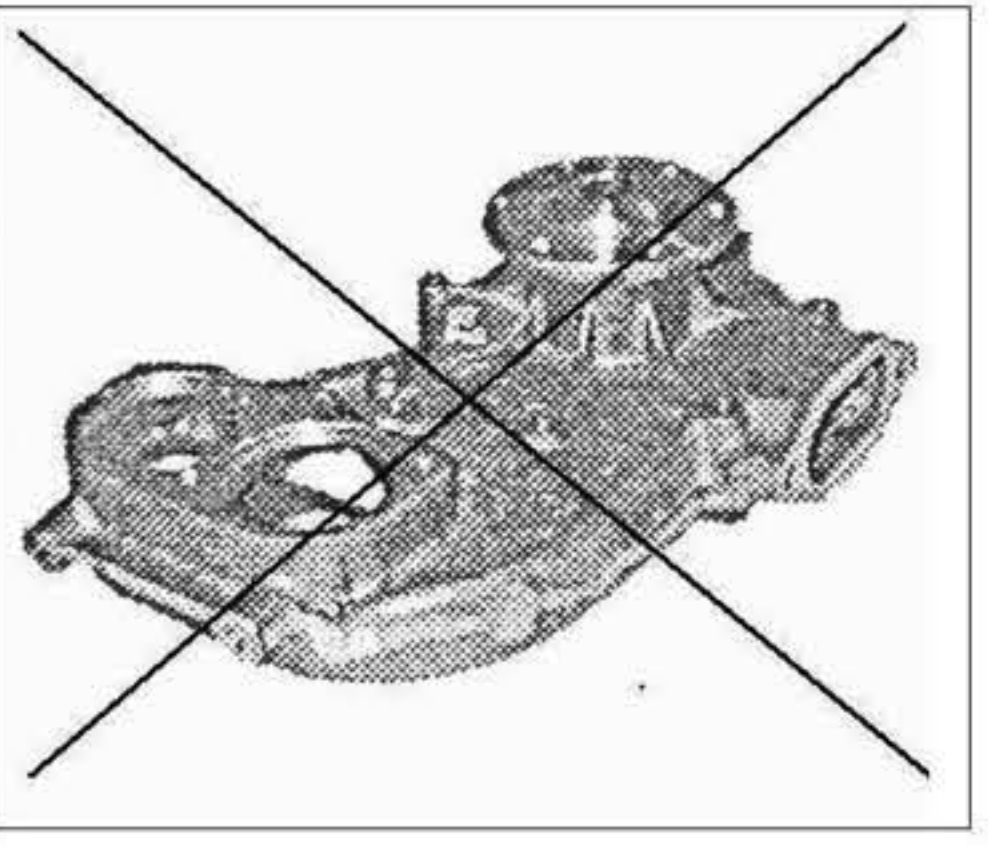
TYPE OR MODEL	ENGINE	WATER PUMP	REPAIR KIT
<p>tutte le versioni con motore all version with engine</p>	<p>OM 447 / LA OM 449 A / LA BRAZIL</p>	<p>241.865 475.200.01.01</p>  <p>note : girante / impeller Ø 135 mm</p>	<p>242.237 422.200.04.04</p> 
<p>VARIO 612 D - 812 D</p> <p>614 D - 714 D - 814 D</p> <p>WL - WM 711 - 811 - 814 817 - 917 - 1117 - 1317 - 1517</p> <p>ATEGO 815, 817, 1017, 1217 1223, 1523 OM 904 ENGINE</p>	<p>OM 904 LA ECOPOWER OM 904.908</p> <p>OM 904.906</p> <p>OM 904.905 / .906 OM 904.907</p> <p>OM 904 LA OM 906 LA</p>	<p>241.850 904.200.04.01</p>  <p>One Thermostat</p> <p>OM 904 LA</p>	<p>241.851 906.200.04.01</p>  <p>NEW</p> <p>Two Thermostats</p> <p>OM 906 LA - OPTARE SOLO MK11 CITARO - BUS</p>
<p>ACTROS 1831, 1835, 1840, 1843</p> <p>2643</p>	<p>OM 501 LA</p>	<p>241.855 542.200.19.01</p>  <p>135 mm Impeller OM 501</p>	<p>241.700 541.200.12.01</p>  <p>125 mm Impeller OM 501</p>
<p>ACTROS 1848, 1853, 1857</p> <p>Retarder Flange</p>	<p>OM 502 LA</p>	<p>241.860 542.200.06.01</p>  <p>OM502 + Retarder Flange</p>	<p>542.200.0501</p>  <p>Special Application Version of OM501</p>

MERCEDES BENZ



Tel: +(0)44 1925 850082 Fax: +(0)44 1925 850083
www.spwaterpumps.co.uk

TYPE OR MODEL	ENGINE	WATER PUMP	REPAIR KIT
MERCEDES ACTROS 11 GENERATION 1850, 1854, 1858 542.200.2101	OM502 LA V8, 15.9 Ltr	241.703 Actros 11 Generation	
MERCEDES ACTROS 11 GENERATION 542.200.2201 For Units - WITH RETARDER	OM502 LA V8, 15.9 Ltr	241.704 Retarder Flange Actros 11 Generation	
MERCEDES OM442 442.200.0701	OM442 OM457 HLA 6 Cyl Retarder Flange → 442.200.0701 Plugged Hole →	241.708 	241.705 No Retarder Flange 457.200.0801 OM 457HLA
MERCEDES 1938, 1944, 2638 AXOR 1835LS, 1840LS 1843LS, 2535LS 2450LS, 2543LS 0 505, Citaro G, Citaro U Connecto H, Integro Turismo 15 RHD Travedo, 15RH, 15RHD Travedo 17 RHF	OM457 LA OM457 HLA 17mm Hole 125mm Impeller Retarder Flange → 457.200.0501 17mm Hole →	241.710 	

MERCEDES



Tel: +(0)44 1925 850082 Fax: +(0)44 1925 850083
www.spwaterpumps.co.uk

TYPE OR MODEL	ENGINE	WATER PUMP	REPAIR KIT