

WATER PUMP CATALOGUE

TRUCK & BUS SECTION

ALL MAKES

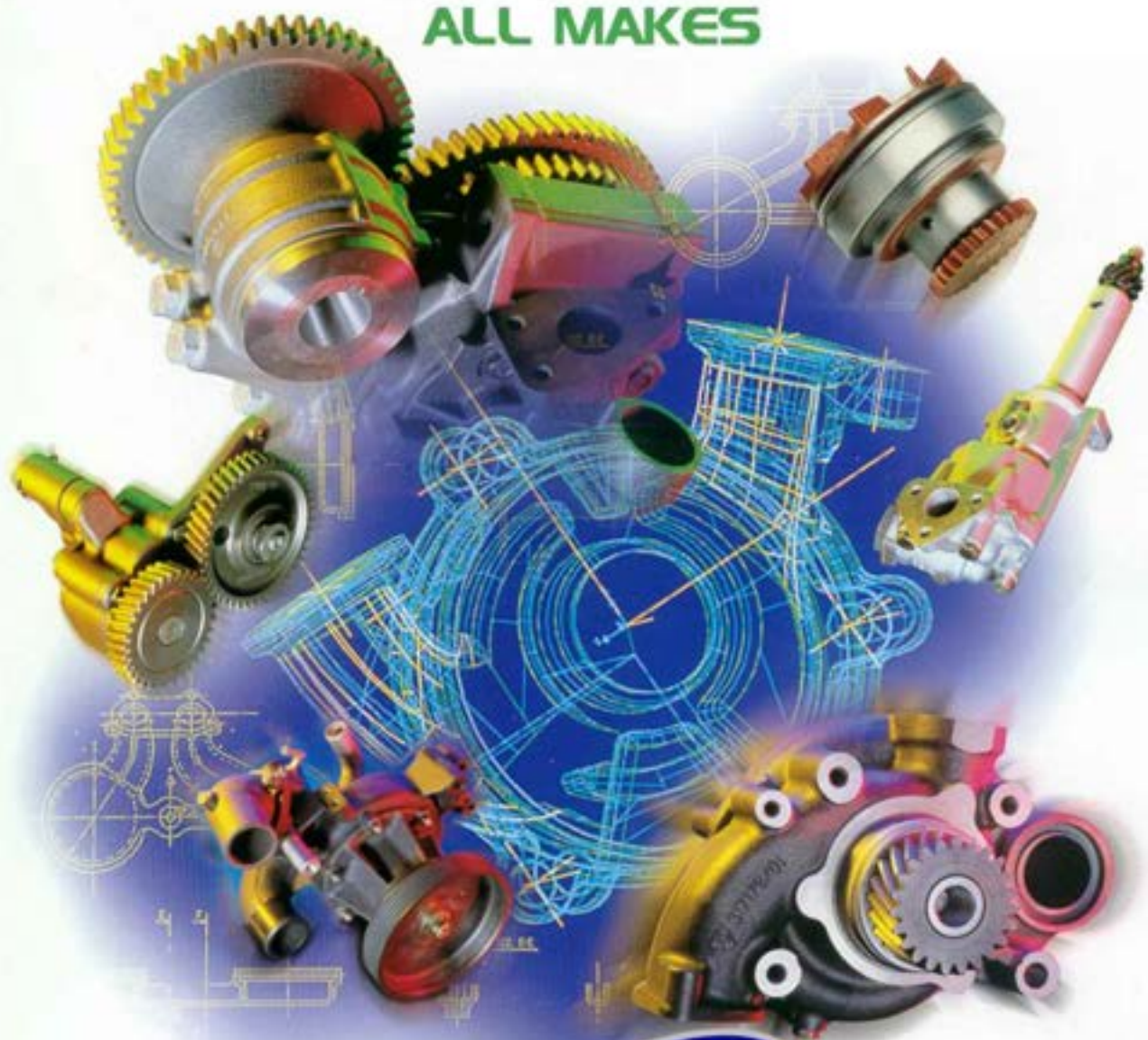

SP

WATER PUMPS

WEB EDITION

S.P. WATER PUMPS LTD

18 Tatton Court, Kingsland Grange, Woolston,
Warrington, Cheshire, ENGLAND, WAI 4RR

TEL: +44(0)1925 850082 FAX: +44(0)1925 850083

Email:sales@spwaterpumps.co.uk Web Site:www.spwaterpumps.co.uk



SECTION 41

APPLICATION

VOLVO

**WATER PUMPS WASSERPUMPEN
POMPE A EAU BOMBA DE AGUA
POMPA ACQUA**

**S.P. WATER PUMPS LTD
18 Tatton Court, Kingsland Grange, Woolston,
Warrington, Cheshire. ENGLAND. WAI 4RR
TEL: +44(0) 1925 850082 Fax: +44(0) 1925 850083
Email:sales@spwaterpumps.co.uk Web Site:www.spwaterpumps.co.uk**

TAVOLE DI CONVERSIONE
TABLE DE CONVERSION
CONVERSION TABLE

VOLVO



NUMERO ORIGINALE NUMERO ORIGINAL ORIGINAL NUMBER	NUMERO SOSTITUTIVO REPLACE PAR NUMERO REPLACED BY NUMBER	RIFERIMENTO OMP REFERENCE OMP OMP REFERENCE
11.012		
11.013		311.809
11.020		
18.559		317.076
70.913		317.004
114.027		317.078
181.286		317.028
181.538		317.017
181.670	1660.609	
181.785		319.028
192.154		319.041
270.791		312.175
271.134	3097.084	
275.607	276.806	312.170
275.608	275.618	
275.609	3097.204	312.173
275.613		312.169
275.614		312.176
275.615	276.802	312.171
275.617		312.177
275.618	276.800	312.172
275.623	3097.203	312.174
275.624	275.625	
275.625	276.053	
275.986	276.800	312.178
276.053	276.054	
276.054	276.803	
276.121		312.291
276.636		312.292
276.637		312.293
276.800		312.285
276.802		312.276
276.803	276.835	
276.806		312.275
276.814		312.278
276.835		312.277
276.852		312.296
417.638		317.103
420.150	420.262	
420.156		317.056
420.160		317.008
420.162		317.051
420.169		317.053
420.262	465.242	
420.759	465.884	
421.148		317.116
421.150	421.275	

NUMERO ORIGINALE NUMERO ORIGINAL ORIGINAL NUMBER	NUMERO SOSTITUTIVO REPLACE PAR NUMERO REPLACED BY NUMBER	RIFERIMENTO OMP REFERENCE OMP OMP REFERENCE
421.174	1542.833	
421.275	466.833	
421.306		317.007
422.148		317.115
422.150	422.311	
422.171		317.065
422.202		317.015
422.311		317.050
422.312	467.906	
422.791	1675.945	317.190
422.792		
423.125		317.113
423.127		317.039
423.129		317.042
423.148		317.118
423.333		317.090
423.351		317.094
423.352		317.095
423.459		317.106
423.460		317.107
424.032	469.418	
424.033	469.115	
424.035		317.117
424.036		
424.037		317.074
424.038		317.079
424.138	469.015	
424.722	425.268	
424.971	425.267	
424.973		
425.267		317.280
425.268		317.290
425.308		317.180
425.524	425.308	
425.707	425.751	
425.751		317.300
425.961	425.751	
465.242		317.040
465.475	1698.613	
465.542	1699.783	
465.765	1699.783	
465.884	471.500	
466.078		317.054
466.088		317.030
466.091		317.052
466.268	466.833	
466.286		317.055

OGNI RIFERIMENTO ORIGINALE E' ASSOLUTAMENTE INDICATIVO. CHAQUE REFERENCE ORIGINAL EST ABSOLUMENT INDICATIVE. EVERY ORIGINAL PART NUMBER HAS TO BE CONSIDERED FOR REFERENCE PURPOSE ONLY.

TAVOLE DI CONVERSIONE
TABLE DE CONVERSION
CONVERSION TABLE

VOLVO



NUMERO ORIGINALE NUMERO ORIGINAL ORIGINAL NUMBER	NUMERO SOSTITUTIVO REPLACE PAR NUMERO REPLACED BY NUMBER	RIFERIMENTO OMP REFERENCE OMP OMP REFERENCE
466.756	466.833	
466.833	1698.614	
467.181		317.112
467.204	467.915	
467.575		317.023
467.576		317.069
467.686	467.907	
467.687		317.022
467.906	1698.615	317.060
467.907	1545.248	
467.915	1545.427	317.070
468.245		317.033
468.246		317.034
468.247		317.029
468.250	468.937	
468.937	470.232	
469.015		317.086
469.115	469.861	
469.418		317.038
469.477		317.096
469.714		
469.744	425.308	
469.746		
469.749		
469.750		
469.751		
469.825		
469.827		
469.828		
469.861	1698.611	
470.216		317.031
470.232	1545.261	
470.265		317.114
471.500	477.397	
477.397	8192.050	
477.770	8192.050	
478.845	1675.945	
479.164	479.931	
479.418	425.751	
479.931	1675.945	
482.226		
482.227		319.018
482.228		319.017
482.229		319.019
482.232		
483.401		
484.035		319.022

NUMERO ORIGINALE NUMERO ORIGINAL ORIGINAL NUMBER	NUMERO SOSTITUTIVO REPLACE PAR NUMERO REPLACED BY NUMBER	RIFERIMENTO OMP REFERENCE OMP OMP REFERENCE
484.036		
484.094	484.118	
484.118		317.120
914.459		317.077
914.462		317.018
914.526		311.184
925.069	925.092	
925.091		317.049
925.092		317.093
925.254		317.045
925.255		317.087
925.257		317.046
925.262		317.044
925.266		
940.100		317.035
940.135		317.104
941.906	955.920	
941.907	955.894	
942.624		
943.370		317.089
943.371		317.092
943.479		317.123
950.533		317.075
951.739		317.082
951.967		317.085
951.969		317.019
953.243		317.072
953.249		317.024
955.295		311.238
955.513		317.036
955.525		317.057
955.826		317.025
955.852		319.031
955.894	955.921	
955.900		319.032
955.920		317.037
955.921		311.381
958.811		317.032
1542.198		317.137
1542.229		317.136
1542.230	1698.612	
1542.232		317.133
1542.235		317.135
1542.236		317.134
1542.833	1545.283	
1542.870		317.014
1542.871		317.016

OGNI RIFERIMENTO ORIGINALE E' ASSOLUTAMENTE INDICATIVO. CHAQUE REFERENCE ORIGINAL EST ABSOLUMENT INDICATIVE. EVERY ORIGINAL PART NUMBER HAS TO BE CONSIDERED FOR REFERENCE PURPOSE ONLY.

SUITABLE

VOLVO



PENTA

MOTORI

Tel:+44(0)1925 850082 Fax: +(0)44 1925 850083

www.spwaterpumps.co.uk

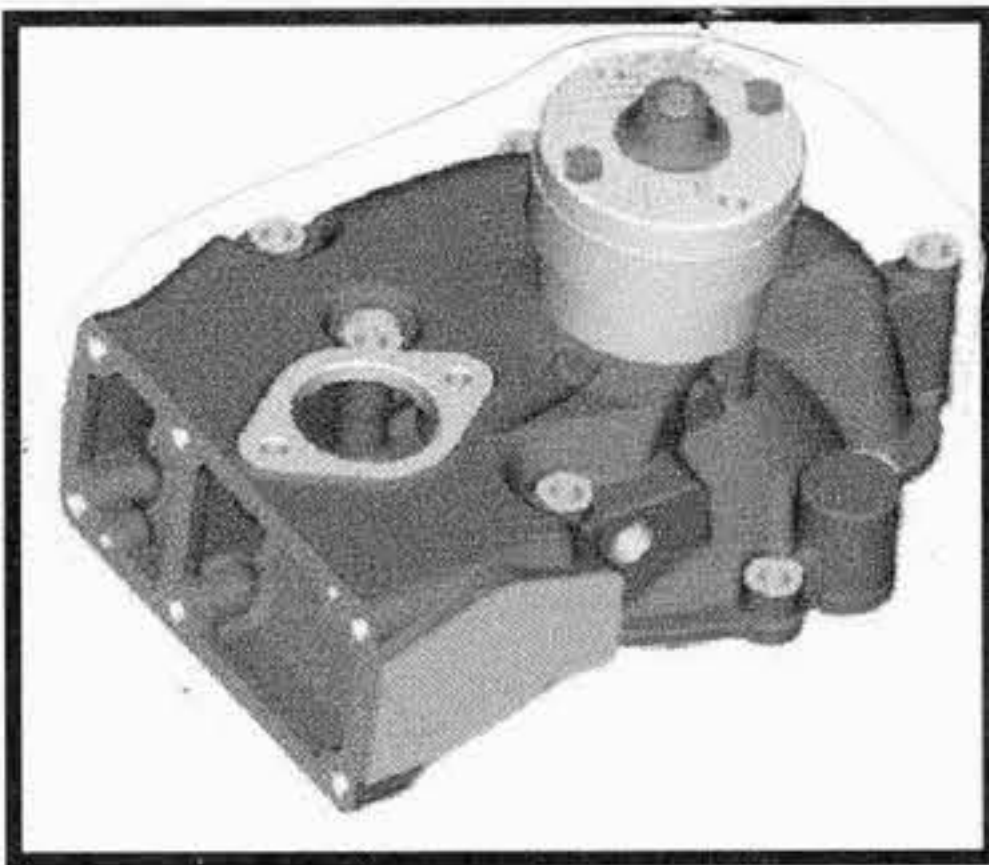
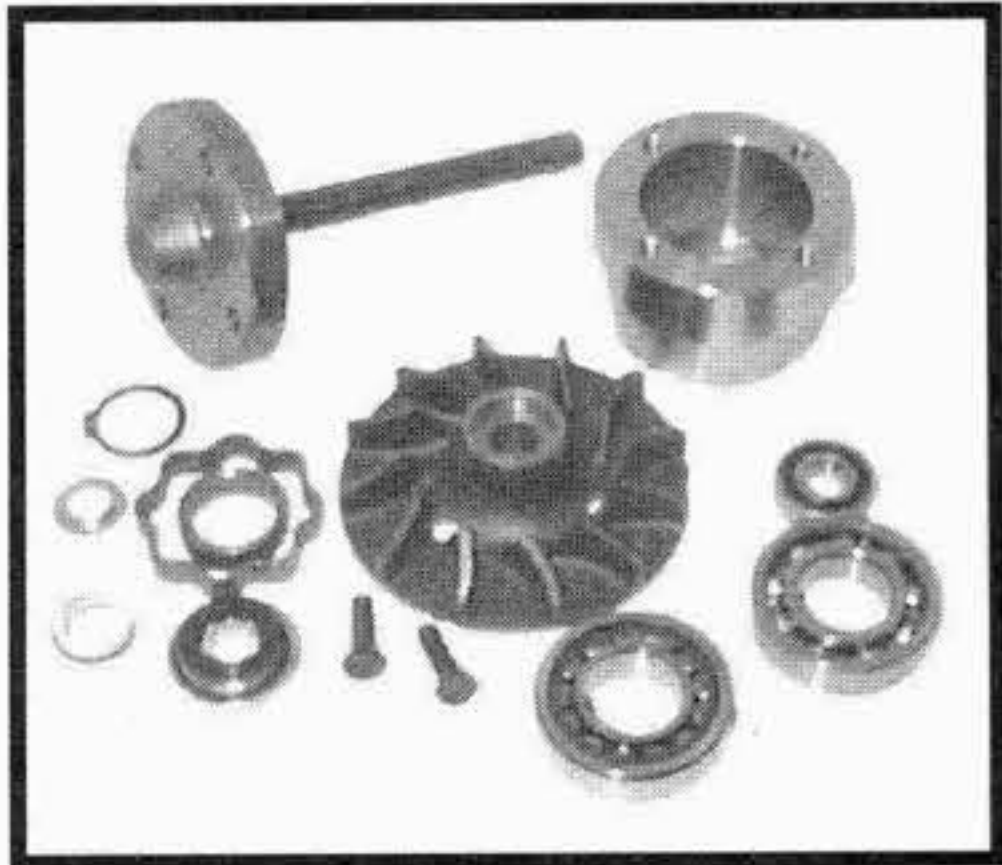
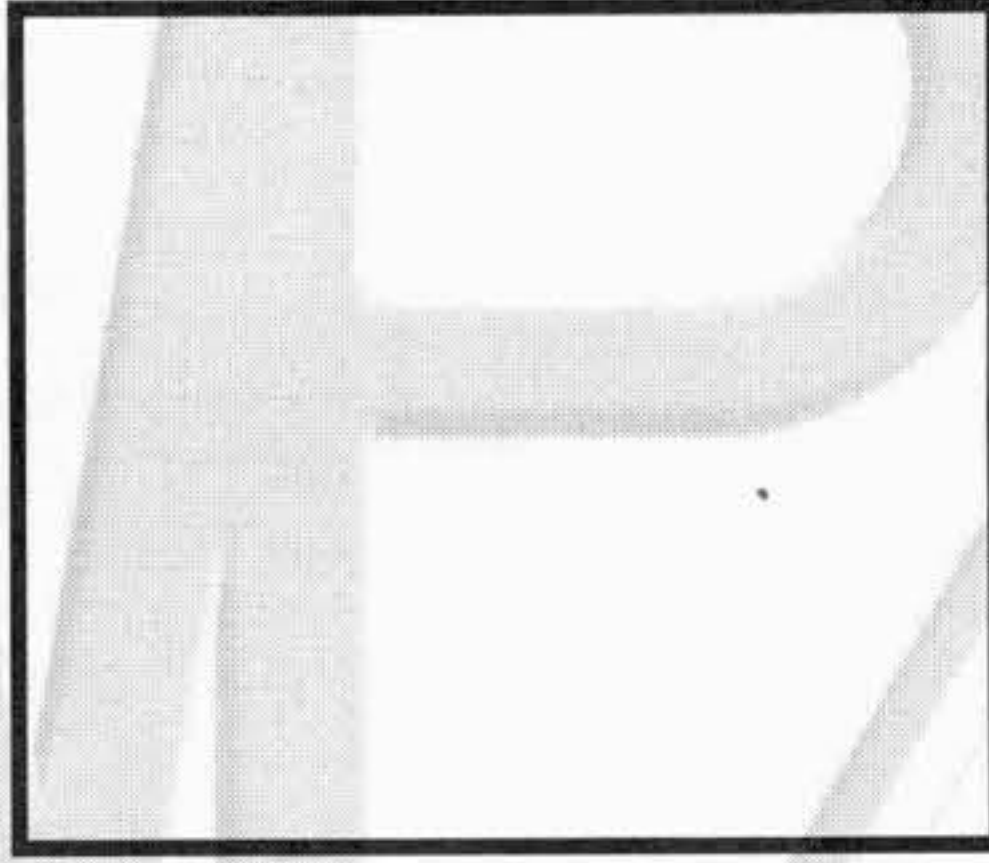
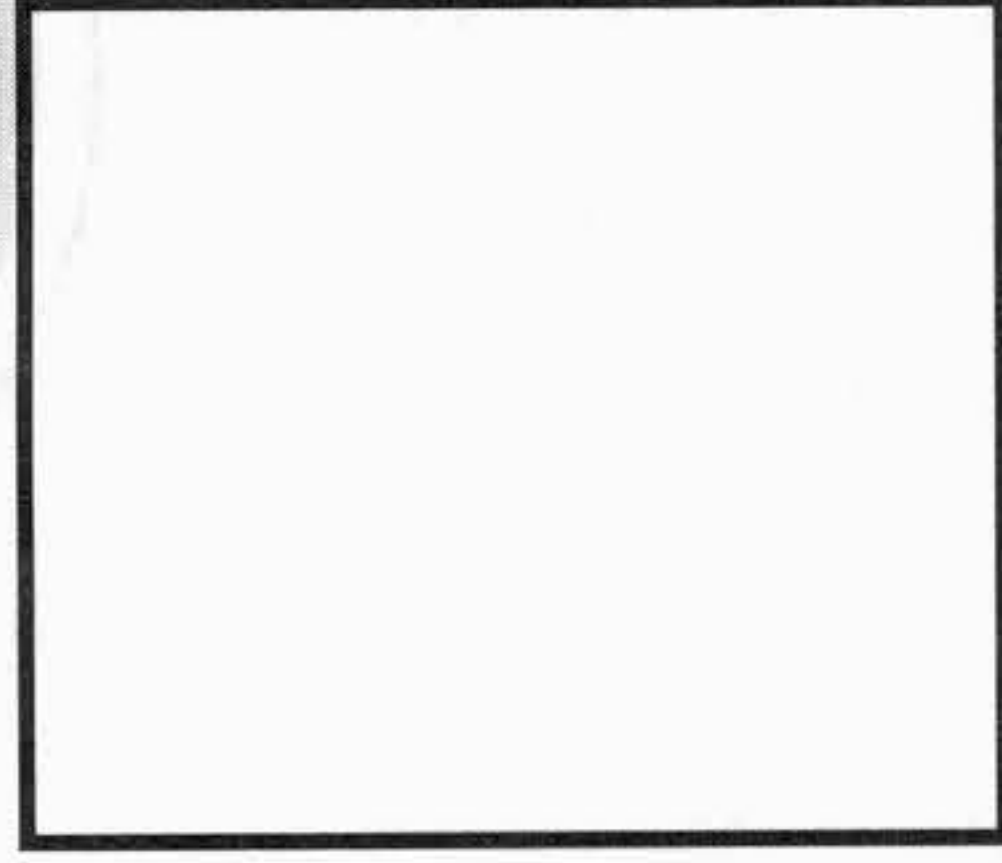
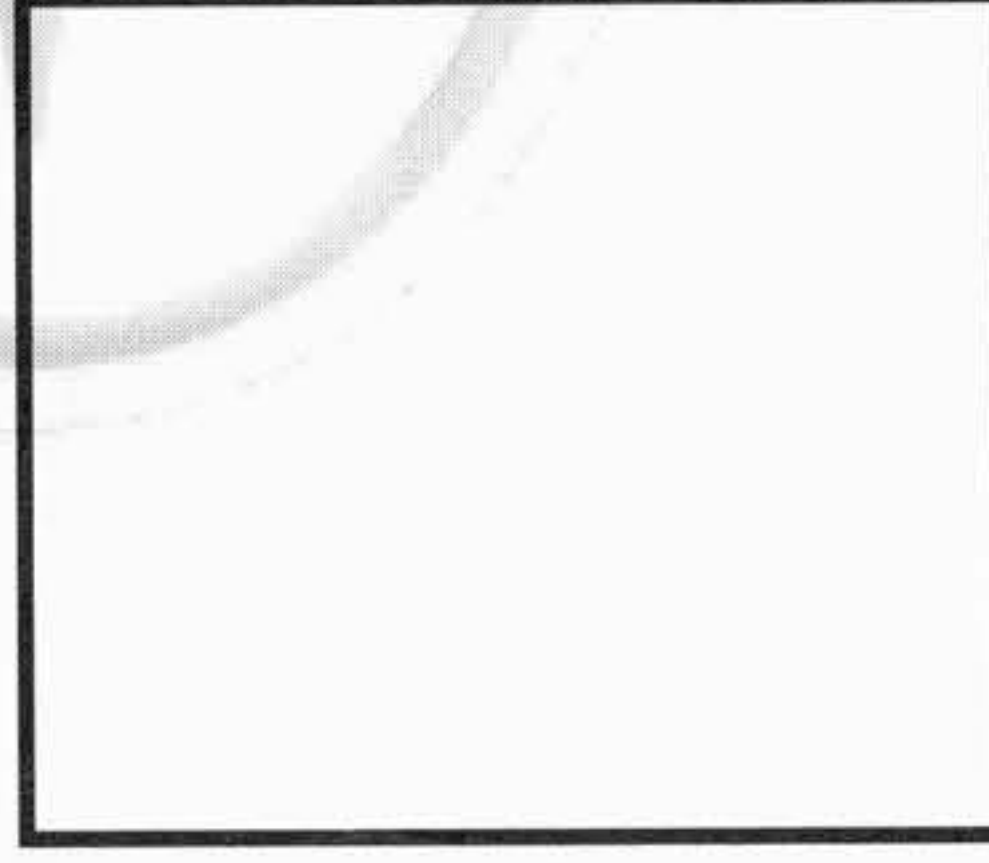

TIPO O MODELLO TYPE OU MODELE TYPE OR MODEL	MOTORE MOTEUR ENGINE	POMPA ACQUA POMPE A EAU WATER PUMP	KIT RIPARAZIONE NECESSAIRE DE REP. REPAIR KIT
		OMP REF. / O.EM. REF	OMP REF. / O.EM. REF
<p>NEW !!</p>	<p>TD 100 G</p>	<p>--- 844.379</p> 	<p>312.290 875.661</p> 
<p>NEW !!</p>	<p>F 4 TD 40 A</p>	<p>317.130 1699.782</p> 	<p>312.177 275.617</p> 
<p>NEW !!</p>	<p>FL 4 TD 41 G 8112525 8112635 Body 1542231</p>	<p>--- 1698.622</p> 	<p>--- ---</p> <p>NON DISPONIBILE NOT AVAILABLE</p>
<p>NEW !!</p>	<p>FLC D4A 135 8113246 3976821</p>	<p>319.510 ---</p> 	<p>--- ---</p> <p>NON DISPONIBILE NOT AVAILABLE</p>

I ricambi non sono originali ma adattabili . Ogni riferimento originale é assolutamente indicativo .
Spare parts are not original but perfectly suitable . Every original part number has to be considered for reference purpose only .

SUITABLE

VOLVO

AUTOCARRI - CAMIONS - TRUCKS - LKW

Tel:+44(0)1925 850082 Fax: +(0)44 1925 850083

www.spwaterpumps.co.uk

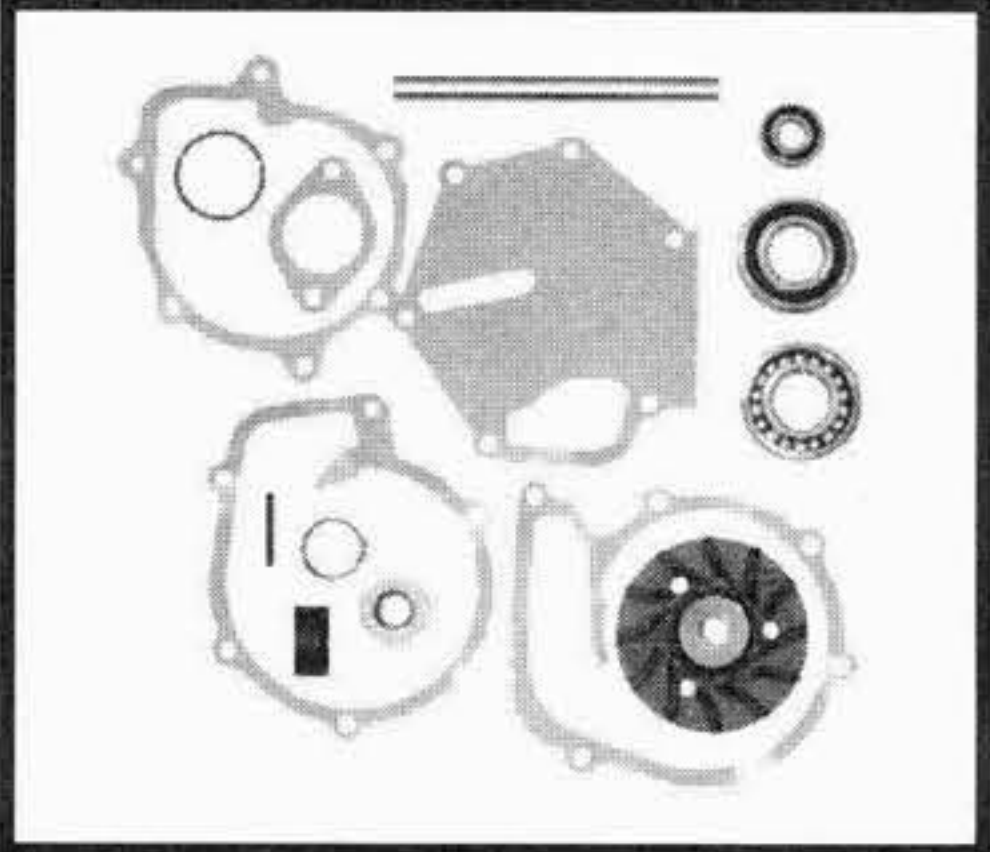
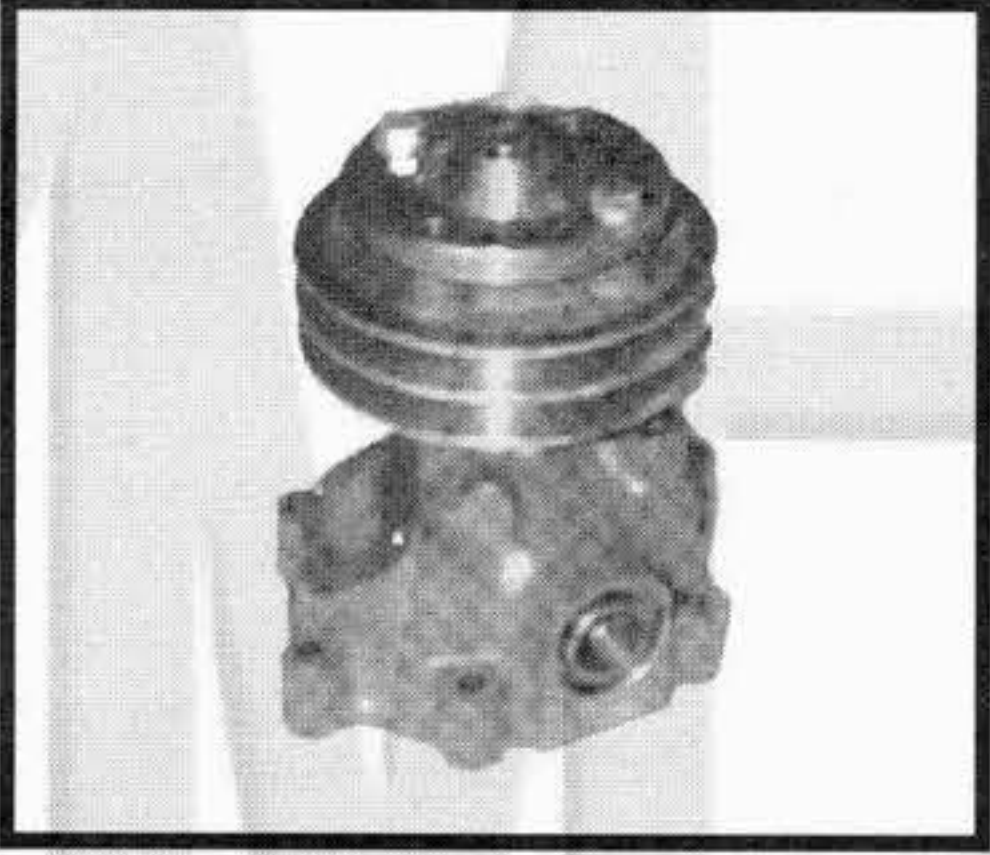
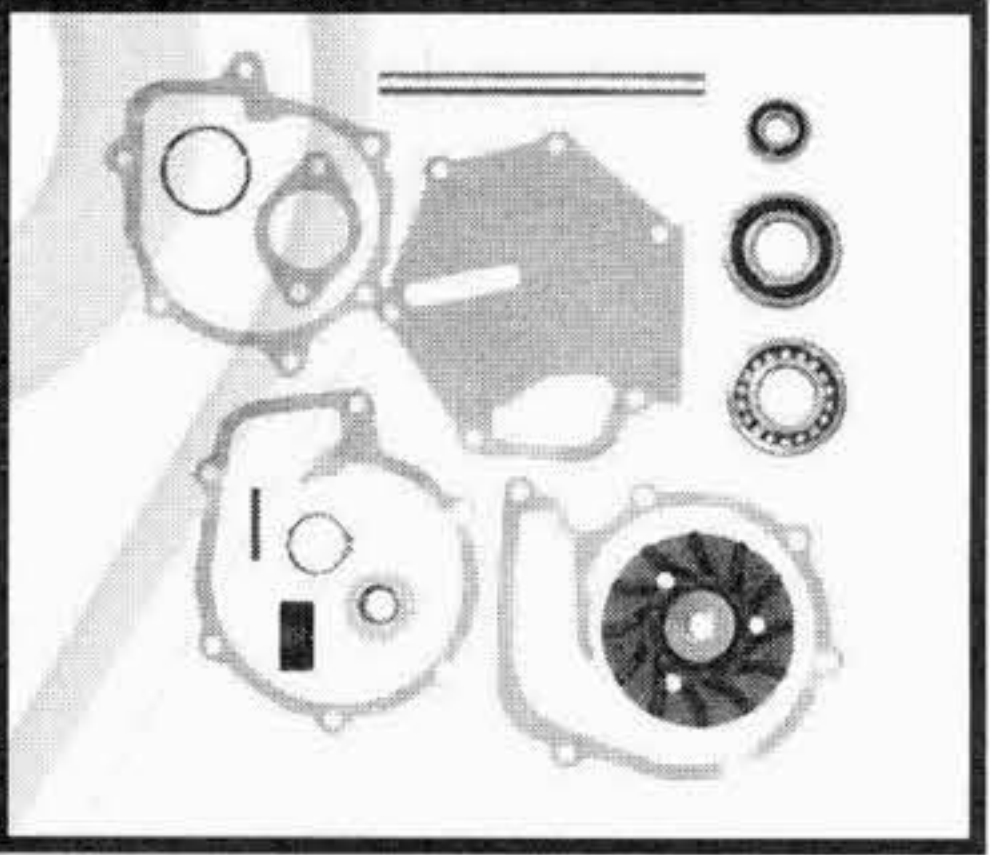
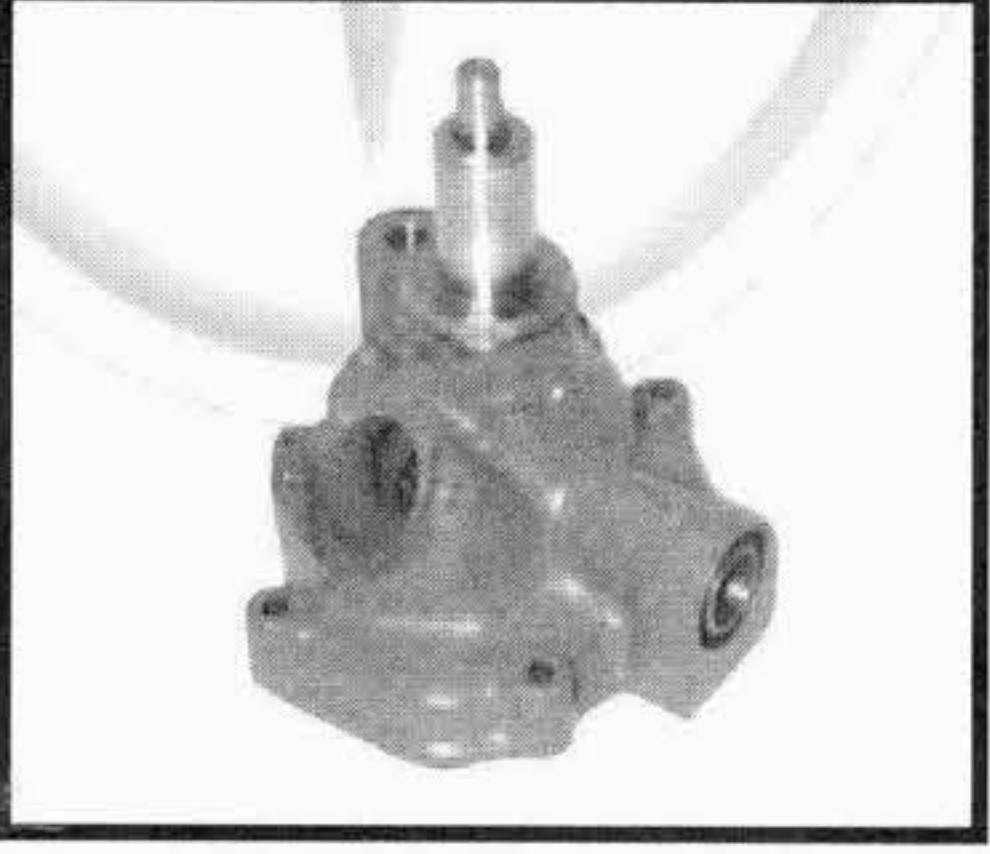
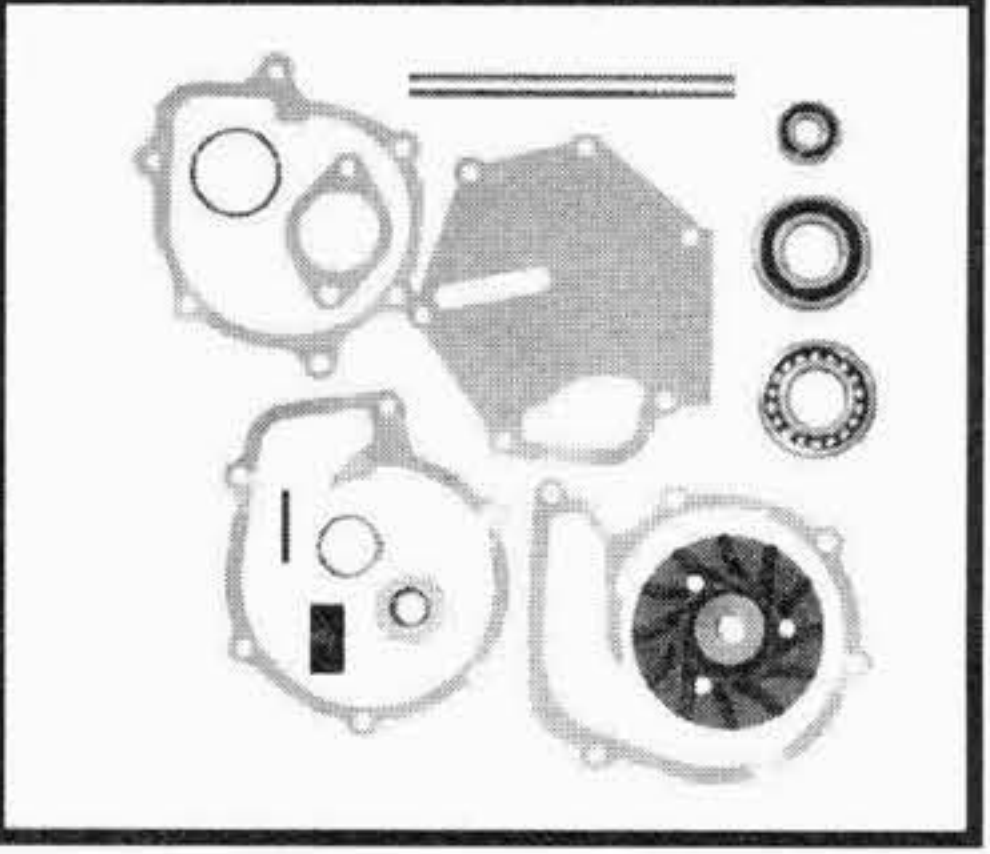
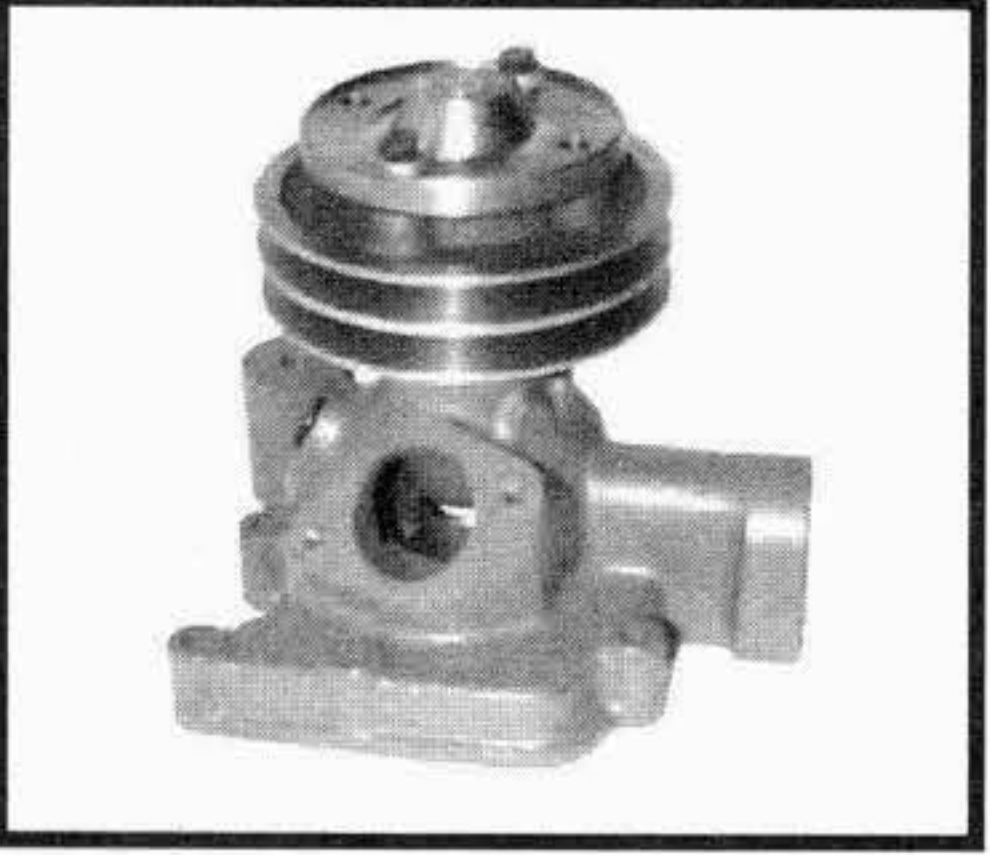
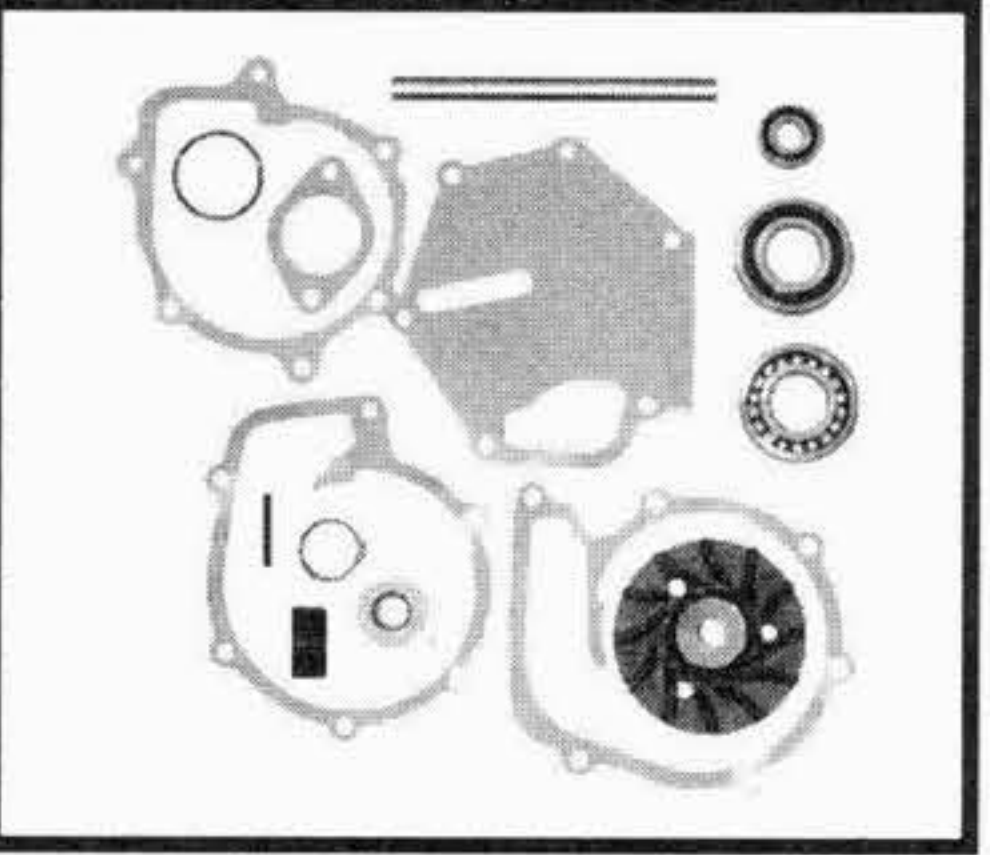

TIPO O MODELLO TYPE OU MODELE TYPE OR MODEL	MOTORE MOTEUR ENGINE	POMPA ACQUA POMPE A EAU WATER PUMP OMP REF. / O.EM. REF	KIT RIPARAZIONE NECESSAIRE DE REP. REPAIR KIT OMP REF. / O.EM. REF
F 6 07 / 08 / 09 / 10 / 11 / 11 USA 12 / 13 / 13 USA / 14 / 14 USA F 84 N 84 F 85	D 60 TD 60 A TD 60 B TD 60 C TD 60 A USA TD 60 B USA	<p>317.040 465.242</p> 	<p>312.275 276.806</p>  <p>in alternativa / alternatively use 312.170 275.607</p>
F 6 S F 6 15 / 16 / 17 F 84 N 84 F 85	TD 60 A TD 60 B	<p>317.110 1699.783</p> 	<p>312.275 276.806</p>  <p>in alternativa / alternatively use 312.170 275.607</p>
F 7 F 86 - N 86 FB 86 F 87 N 87	TD 70 F TD 70 FC TD 70 FS TD 70 F USA TD 70 G TD 70 A TD 70 B TD 70 D TD 70 E	<p>317.000 1699.784</p> 	<p>312.275 276.806</p>  <p>in alternativa / alternatively use 312.170 275.607</p>
N 7 F 86 FB 86 F 87 N 87	TD 70 B TD 70 E TD 70 G TD 70 F TD 70 G	<p>317.030 466.088</p> 	<p>312.275 276.806</p>  <p>in alternativa / alternatively use 312.170 275.607</p>

I ricambi non sono originali ma adattabili . Ogni riferimento originale é assolutamente indicativo .
Spare parts are not original but perfectly suitable . Every original part number has to be considered for reference purpose only .

SUITABLE





VOLVO

AUTOCARRI - CAMIONS - TRUCKS - LKW

Tel:+44(0)1925 850082 Fax: +(0)44 1925 850083

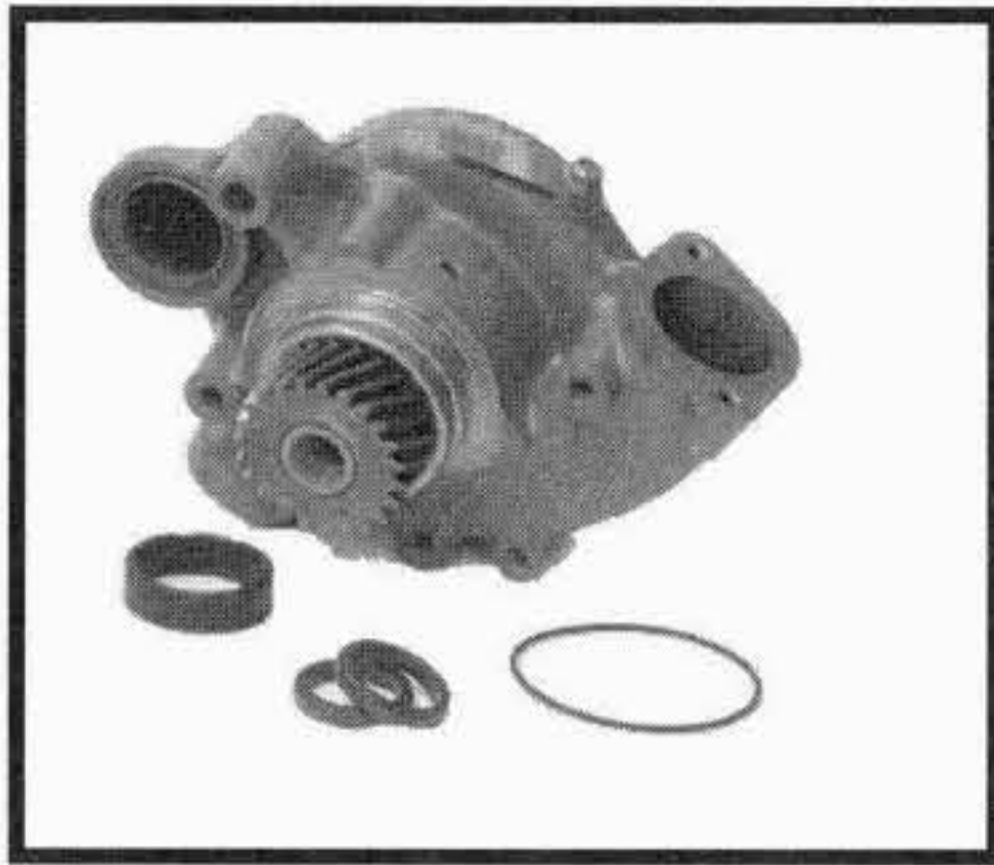
www.spwaterpumps.co.uk

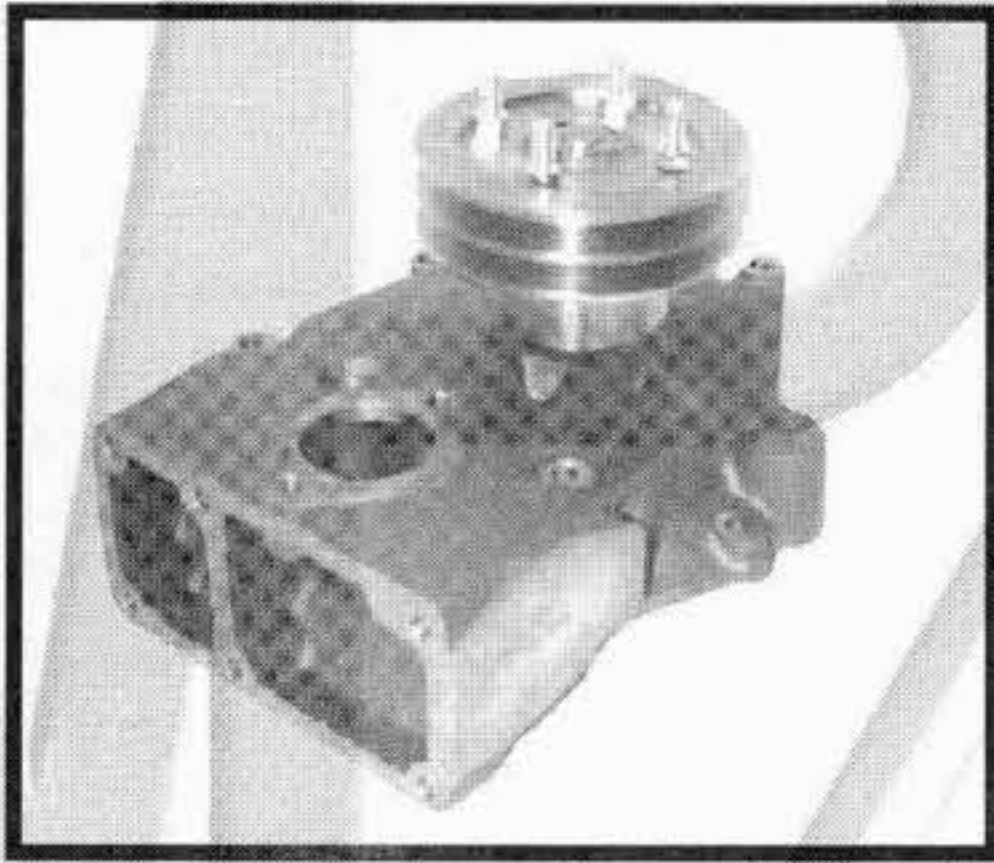

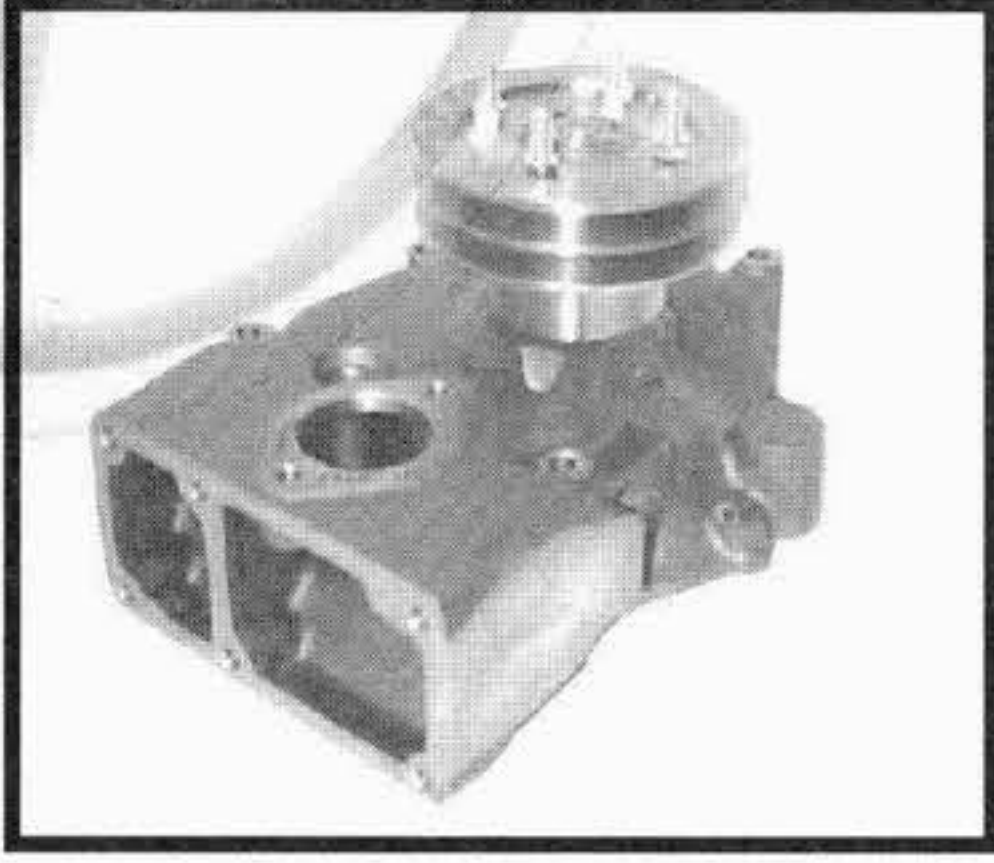
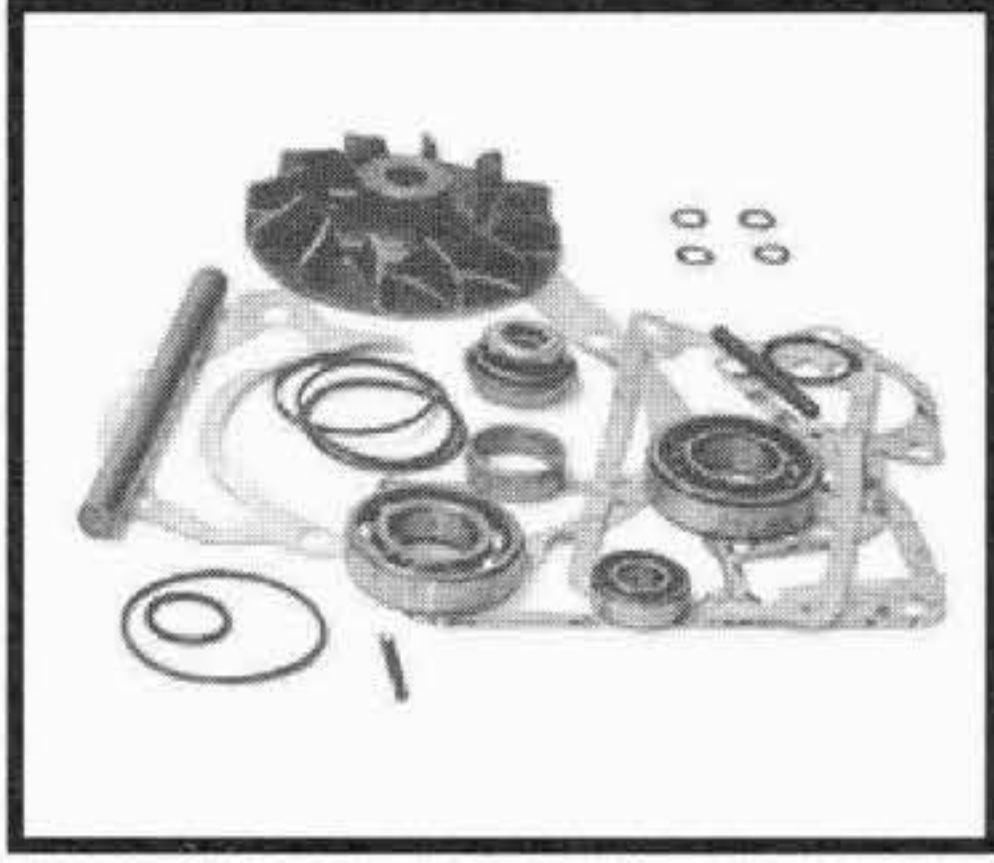
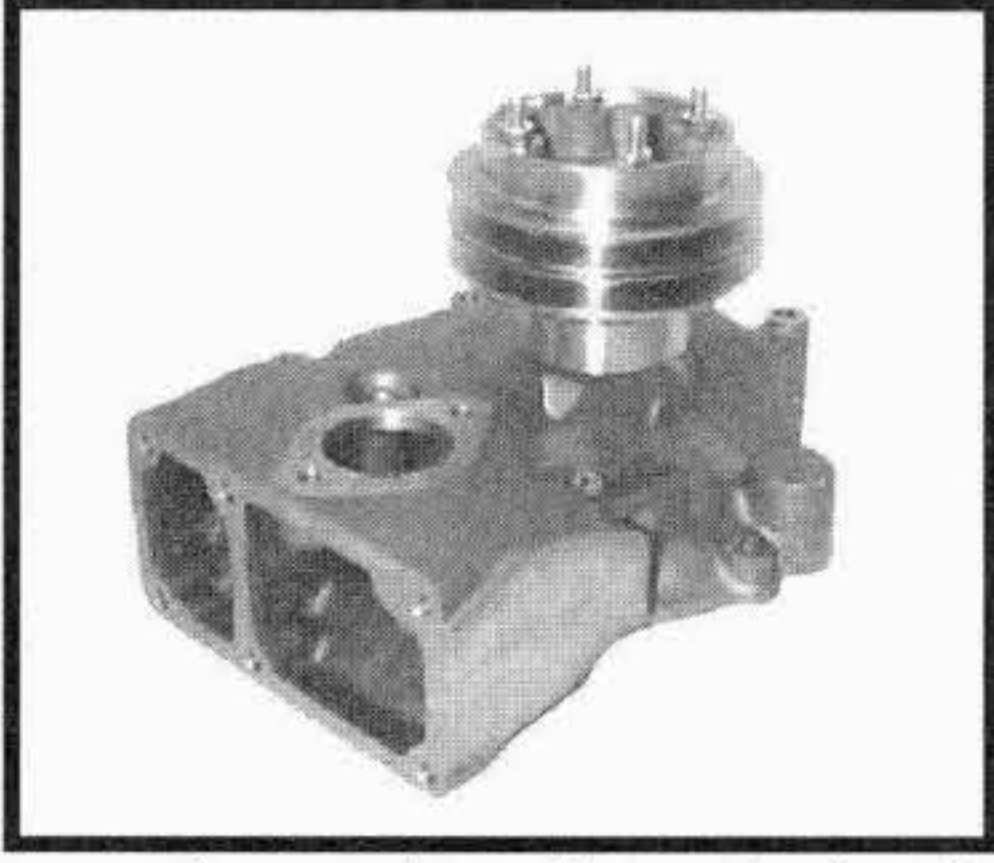
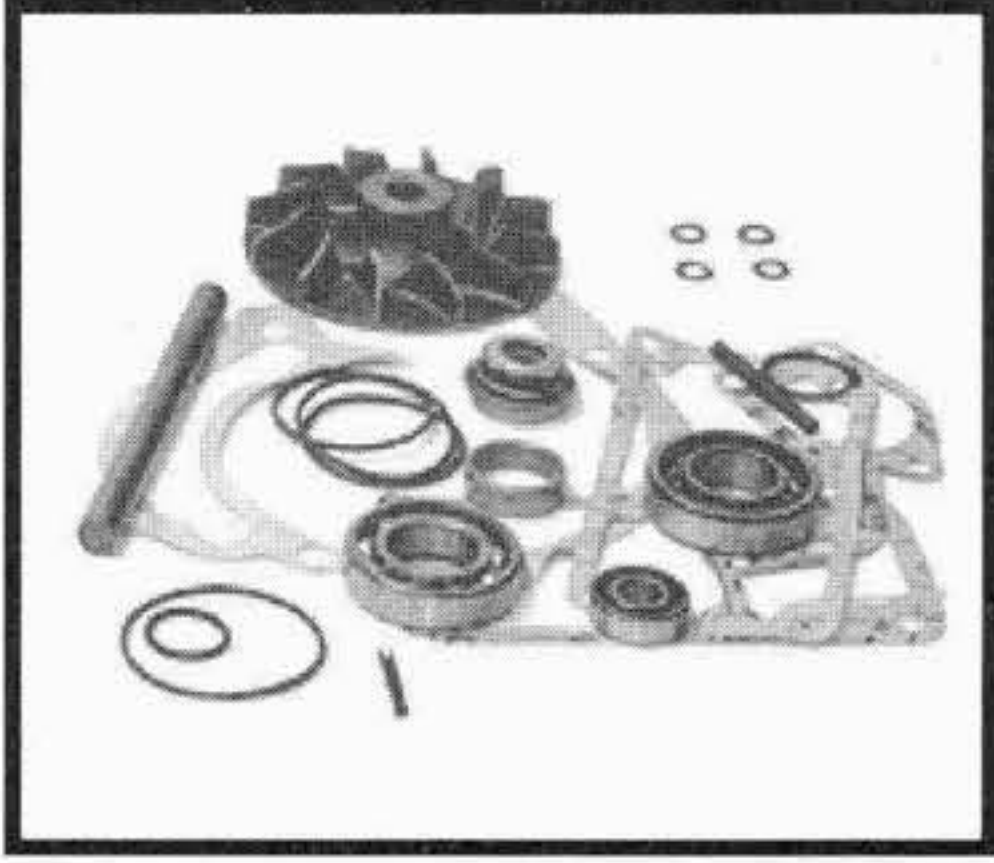
TIPO O MODELLO TYPE OU MODELE TYPE OR MODEL	MOTORE MOTEUR ENGINE	POMPA ACQUA POMPE A EAU WATER PUMP OMP REF. / O.EM. REF	KIT RIPARAZIONE NECESSAIRE DE REP. REPAIR KIT OMP REF. / O.EM. REF
FE 6 FL 6 FL 6 FE 7 FL 7 FS 7 FL 7 FS 7 WHITE	TD 61 TD 63 D 6 TD 71 TD 73 D 7	<p>317.175 8192.050</p> 	<p>312.277 276.835</p> 
F 10 ---> fino al telaio 25000	TD 100 A TD 100 B TD 100 BG TD 100 GA	<p>317.060 467.906</p>  <p>ad esaurimento sost. da / will be supersided by 317.215 1699.785</p>	<p>312.172 275.618</p>  <p>in alternativa / alternatively use 312.285 276.800</p>
F 10 ---> fino al telaio 25000 NEW !!	TD 100 A TD 100 B TD 100 BG TD 100 GA	<p>317.215 1699.785</p> 	<p>312.285 276.800</p>  <p>in alternativa / alternatively use 312.172 275.618</p>
F 10 dal telaio 25001 ---> ---> fino al telaio 314000	TD 101 G TD 101 GA	<p>317.170 1545.246</p>  <p>ad esaurimento sost. da / will be supersided by 317.220 1698.617</p>	<p>312.285 276.800</p>  <p>in alternativa / alternatively use 312.172 275.618</p>





I ricambi non sono originali ma adattabili . Ogni riferimento originale é assolutamente indicativo .
Spare parts are not original but perfectly suitable . Every original part number has to be considered for reference purpose only .

SUITABLE

VOLVO

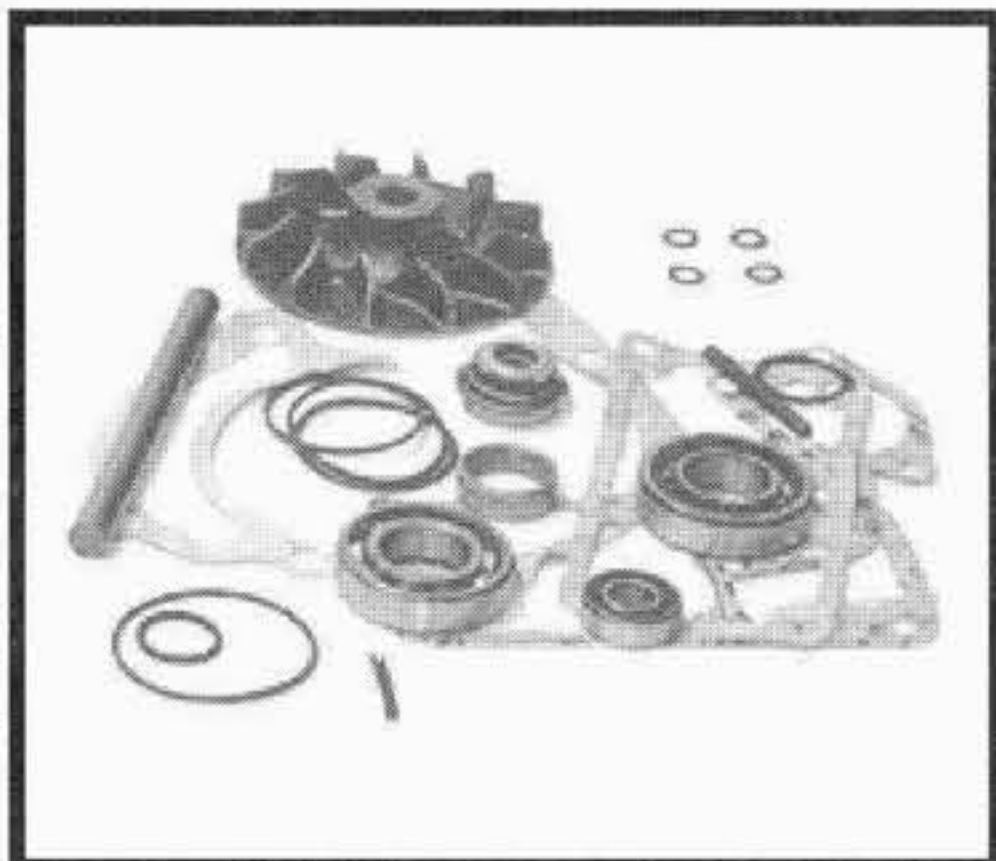
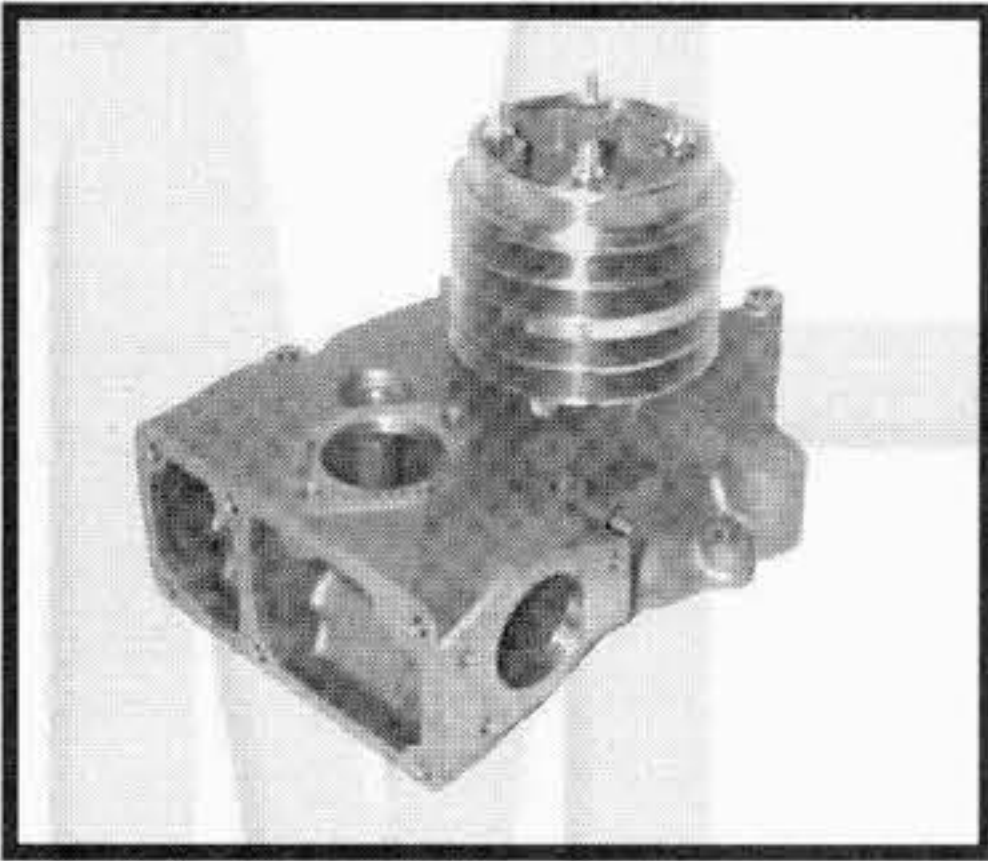
AUTOCARRI - CAMIONS - TRUCKS - LKW
Tel:+44(0)1925 850082 Fax: +(0)44 1925 850083
www.spwaterpumps.co.uk

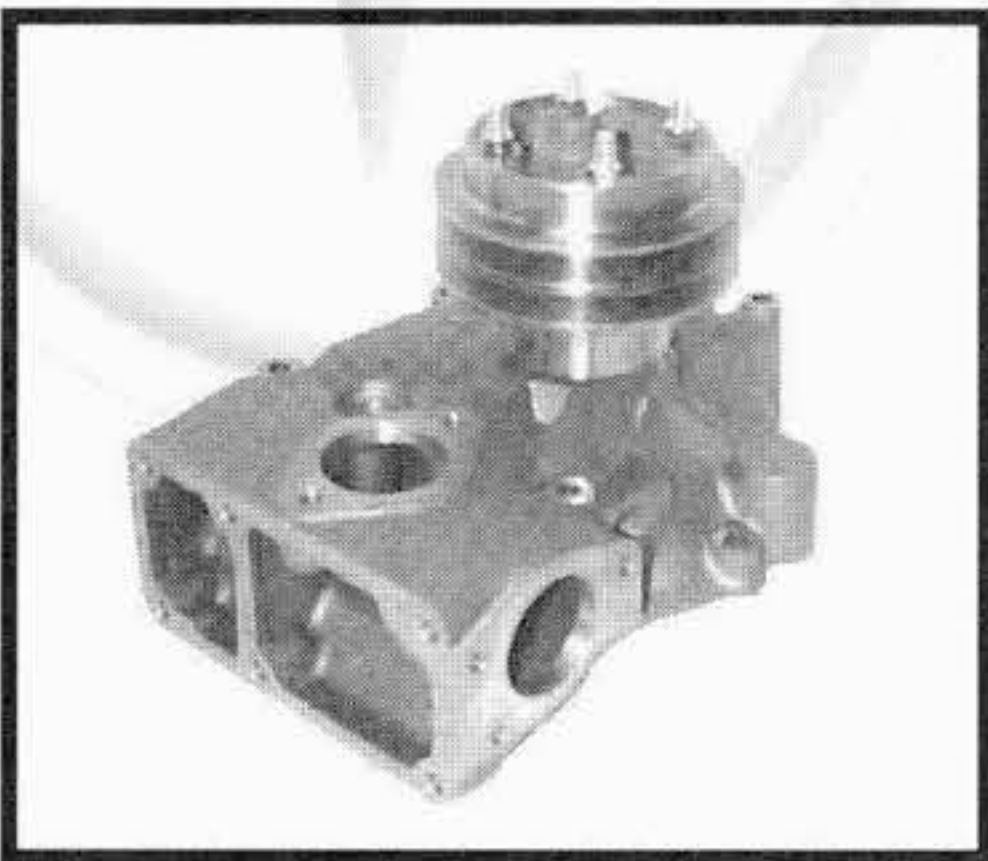
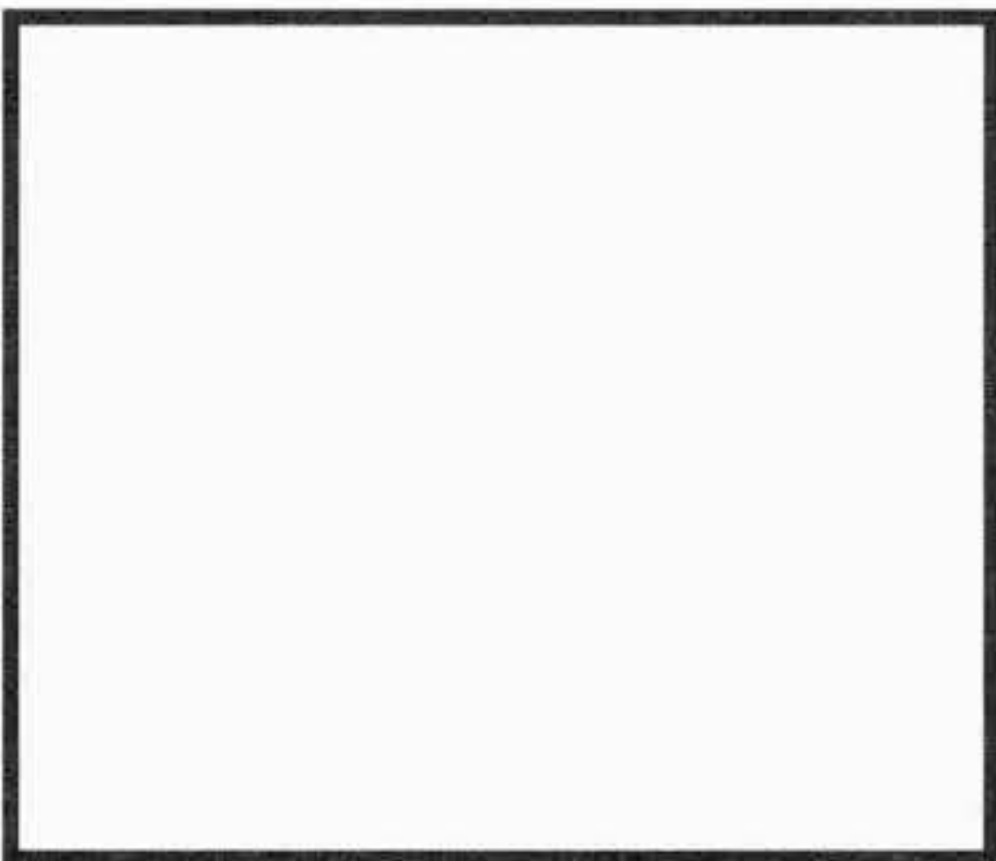

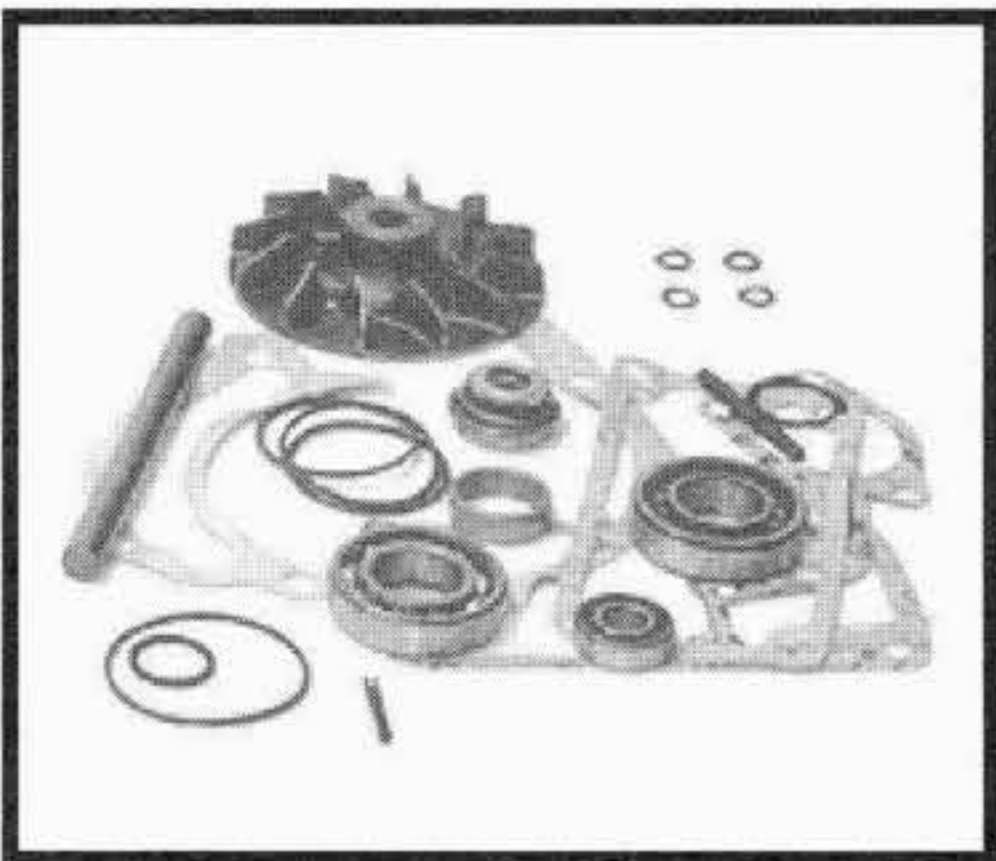
TIPO O MODELLO TYPE OU MODELE TYPE OR MODEL	MOTORE MOTEUR ENGINE	POMPA ACQUA POMPE A EAU WATER PUMP	KIT RIPARAZIONE NECESSAIRE DE REP. REPAIR KIT
<p>F 10</p> <p>dal telaio 25001 ---></p> <p>---> fino al telaio 314000</p> <p>NEW !!</p> <p>F 10 INTERCOOLER</p> <p>dal telaio 314001 ---></p>	<p>TD 101 G</p> <p>TD 101 GA</p> <p>TD 102</p> <p>TD 103</p>	<p>317.220 1698.617</p> 	<p>312.285 276.800</p>  <p>in alternativa / alternatively use 312.172 275.618</p>
<p>N 10</p> <p>---> fino al telaio 49000</p>	<p>TD 100 A</p>	<p>317.070 467.915</p>  <p>ad esaurimento sost. da / will be supersided by 317.225 1699.789</p>	<p>312.172 275.618</p>  <p>in alternativa / alternatively use 312.285 276.800</p>
<p>N 10</p> <p>---> fino al telaio 49000</p> <p>N 10</p> <p>dal telaio 49001 ---></p>	<p>TD 100 B</p> <p>TD 100 BG</p> <p>TD 100 G</p> <p>TD 101 G</p>	<p>317.010 1545.248</p>  <p>ad esaurimento sost. da / will be supersided by 317.230 1699.788</p>	<p>312.172 275.618</p>  <p>in alternativa / alternatively use 312.285 276.800</p>
<p>N 10</p> <p>dal telaio 49001 ---></p> <p>NL 10</p> <p>NL 10 S</p> <p>N 10 MARK II</p> <p>NEW !!</p>	<p>TD 102</p> <p>TD 102</p> <p>TD 102</p>	<p>317.230 1699.788</p> 	<p>312.285 276.800</p>  <p>in alternativa / alternatively use 312.172 275.618</p>





I ricambi non sono originali ma adattabili . Ogni riferimento originale é assolutamente indicativo .
 Spare parts are not original but perfectly suitable . Every original part number has to be considered for reference purpose only .

SUITABLE

VOLVO

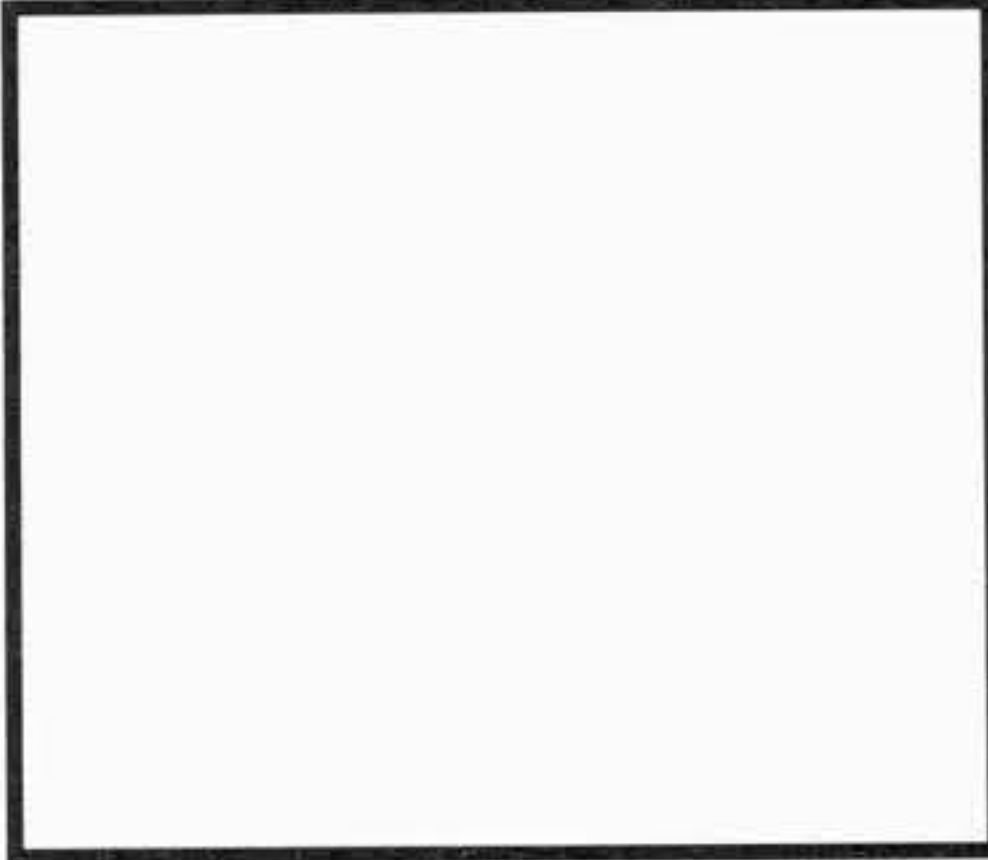
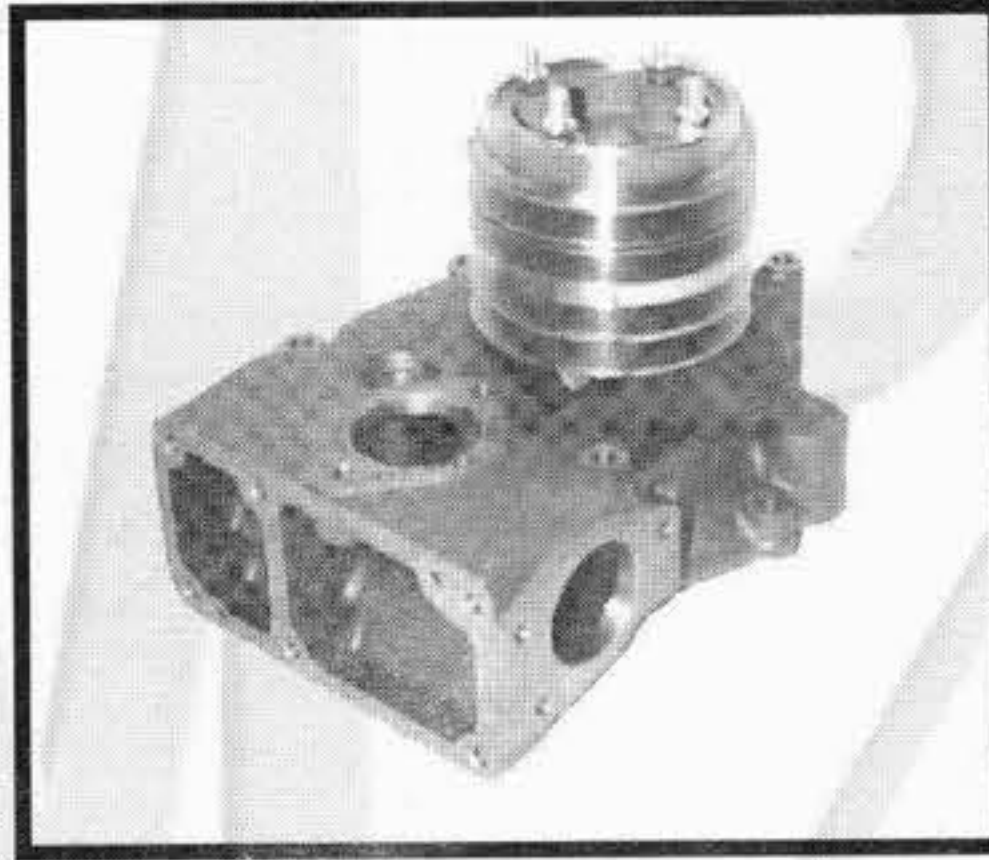
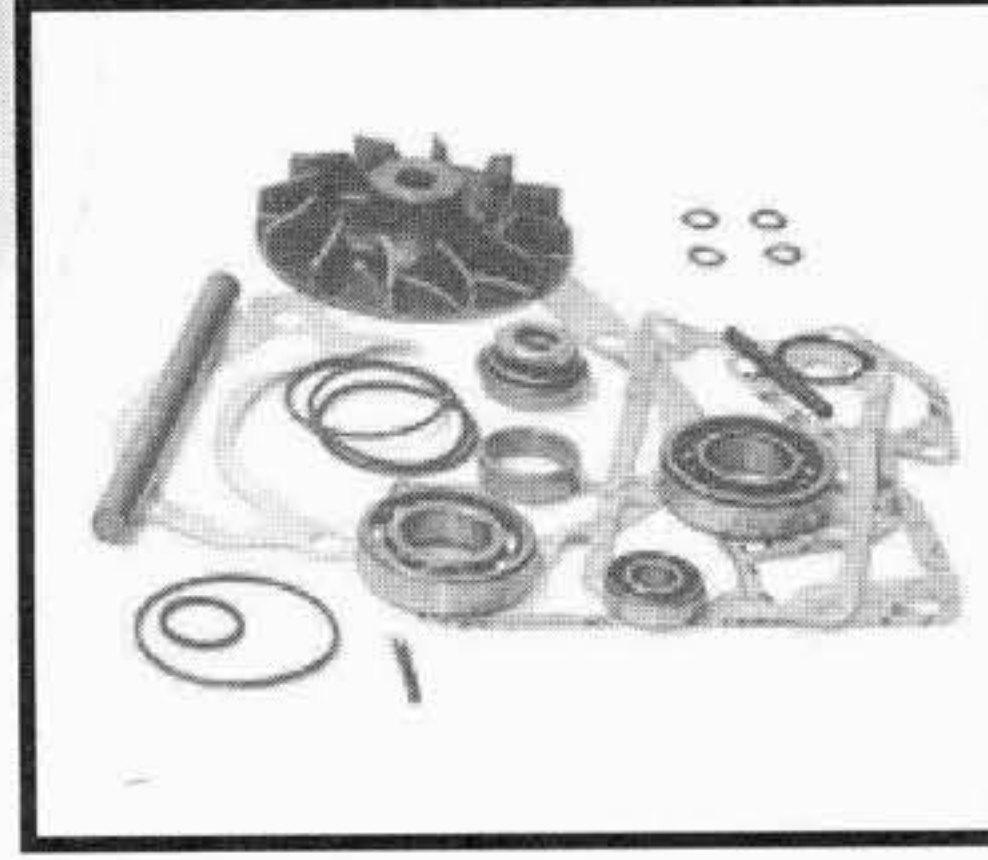
AUTOCARRI - CAMIONS - TRUCKS - LKW
Tel:+44(0)1925 850082 Fax: +(0)44 1925 850083
www.spwaterpumps.co.uk

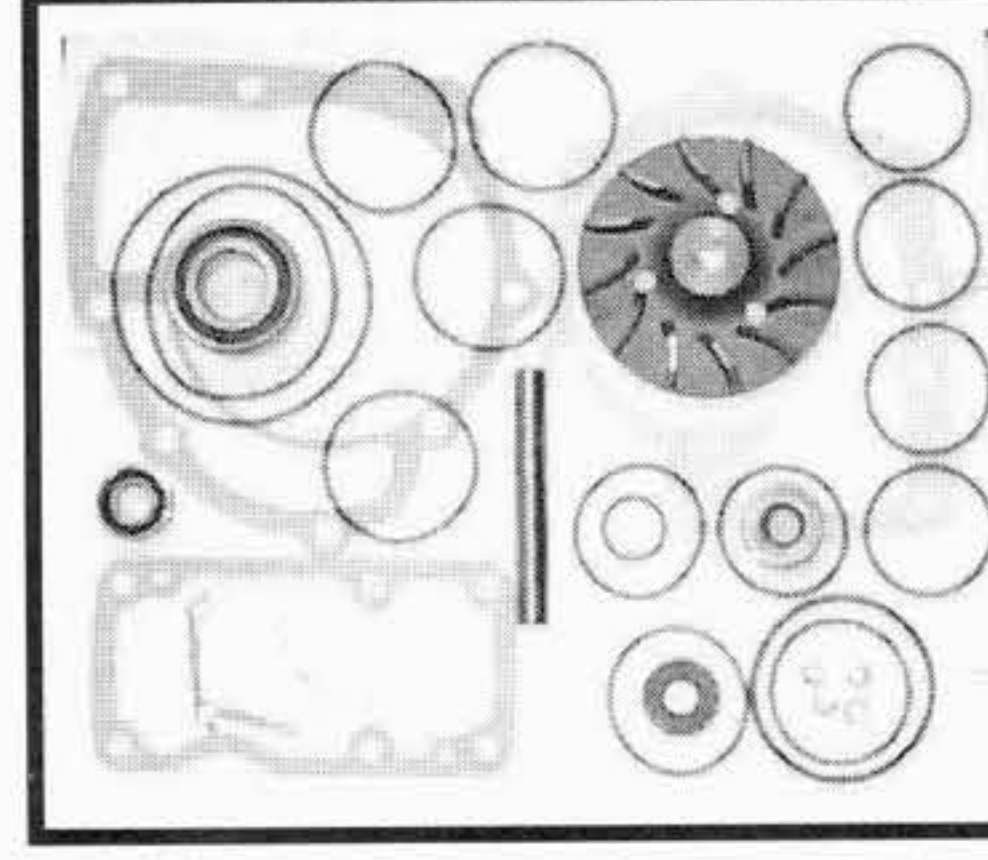

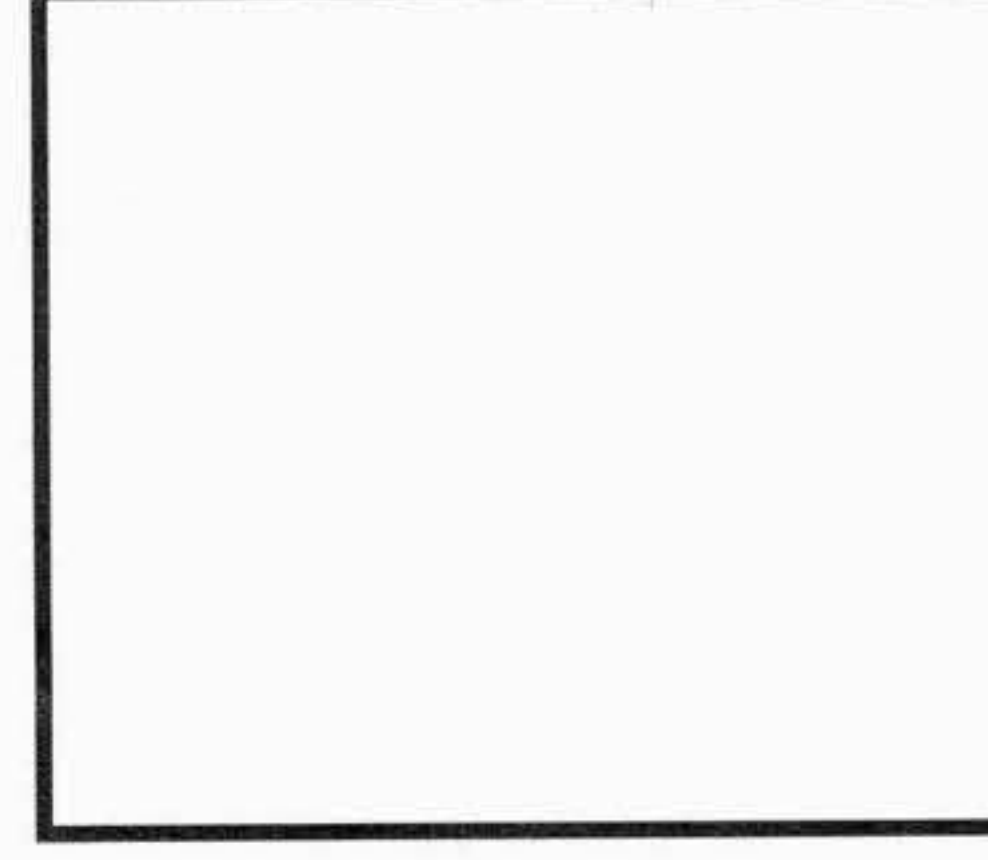
TIPO O MODELLO TYPE OU MODELE TYPE OR MODEL	MOTORE MOTEUR ENGINE	POMPA ACQUA POMPE A EAU WATER PUMP OMP REF. / O.EM. REF	KIT RIPARAZIONE NECESSAIRE DE REP. REPAIR KIT OMP REF. / O.EM. REF
<p>N 10 dal telaio 304000 ---></p> <p>NL 10 S dal telaio 304000 ---></p> <p>N 10 MARK II dal telaio 304000 ---></p>	<p>TD 101 USA</p> <p>TD 101 USA</p> <p>TD 101 USA</p>	<p>317.195 1545.427</p>  <p>ad esaurimento sost. da / will be supersided by 317.225 1699.789</p>	<p>312.178 275.986</p>  <p>in alternativa / alternatively use 312.285 276.800</p>
<p>N 10 dal telaio 304000 ---></p> <p>NL 10 - NL 10 S dal telaio 304000 ---></p> <p>N 10 MARK II dal telaio 304000 ---></p>	<p>TD 101 USA</p> <p>TD 101 USA</p> <p>TD 101 USA</p>	<p>317.225 1699.789</p> 	<p>312.285 276.800</p>  <p>in alternativa / alternatively use 312.172 275.618</p>
<p>F 10 dal telaio 25001 ---></p> <p>FL 10 INTERCOOLER 320</p> <p>FL 10</p> <p>FS 10</p> <p>F 12 ---> fino al telaio 34000</p> <p>F 12 dal telaio 34001 ---></p> <p>F 12 INTERCOOLER 360 dal telaio 314000 ---></p> <p>F 12 INTERCOOLER 420</p> <p>N 12 ---> fino al telaio 12000</p> <p>N 12 dal telaio 12001 ---></p> <p>NL 10 S</p> <p>NL 12 - NL 12 S</p>	<p>TD 101 F</p> <p>TD 102 F</p> <p>TD 101 F</p> <p>TD 102 F</p> <p>TD 120 C/D/E/F/FC/G/GA</p> <p>TD 121 F/FD/G/GD</p> <p>TD 122 FK / FS</p> <p>TD 120 A/E/G/GA</p> <p>TD 121 F/G/GA</p> <p>TD 121 GA</p> <p>TD 122 FK / FS</p>	<p>317.160 1545.261</p> 	<p>312.276 276.802</p>  <p>in alternativa / alternatively use 312.171 275.615</p>
<p>F 10 INTERCOOLER 320</p> <p>F 12 INTERCOOLER 360</p> <p>F 12 INTERCOOLER 420</p>	<p>TD 102 F - OCS</p> <p>TD 122 FK/FS-OCS</p> <p>TD 122 FK/FS-OCS</p>	<p>317.190 422.791</p> 	<p>312.175 270.791</p> 

NEW !!

I ricambi non sono originali ma adattabili . Ogni riferimento originale é assolutamente indicativo .
 Spare parts are not original but perfectly suitable . Every original part number has to be considered for reference purpose only .

SUITABLE





VOLVO

AUTOBUS - AUTOCARS - BUSES - OMNIBUSSE

Tel:+44(0)1925 850082 Fax: +(0)44 1925 850083

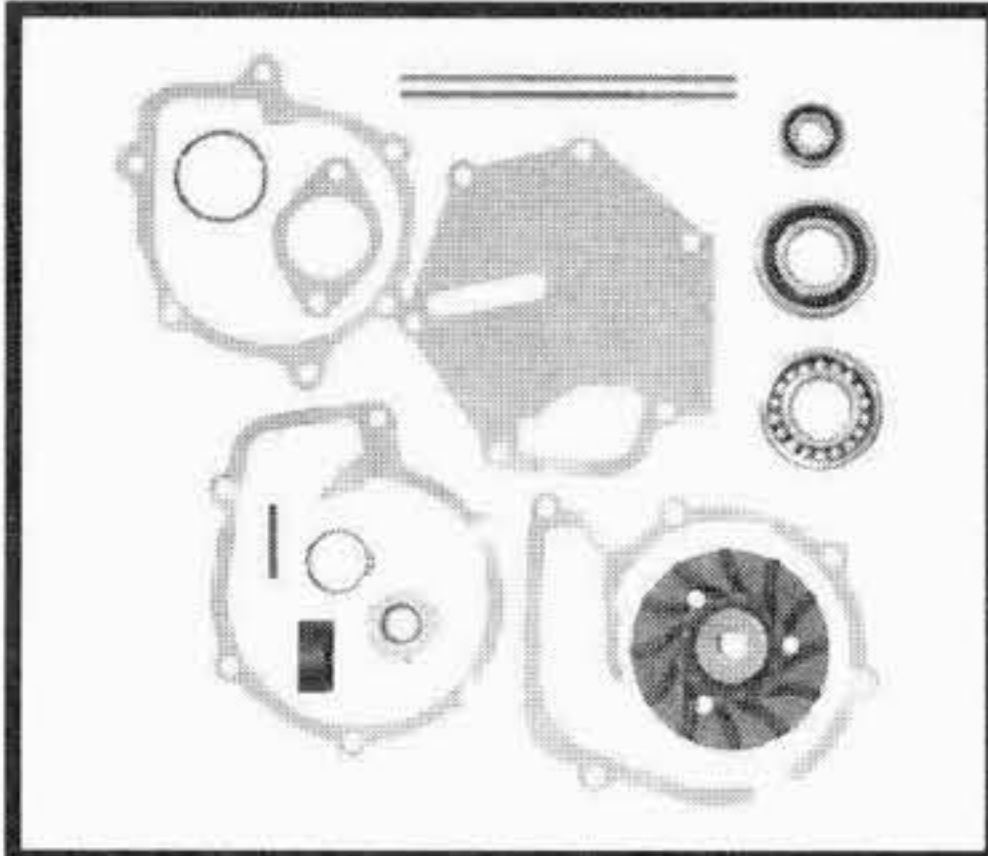
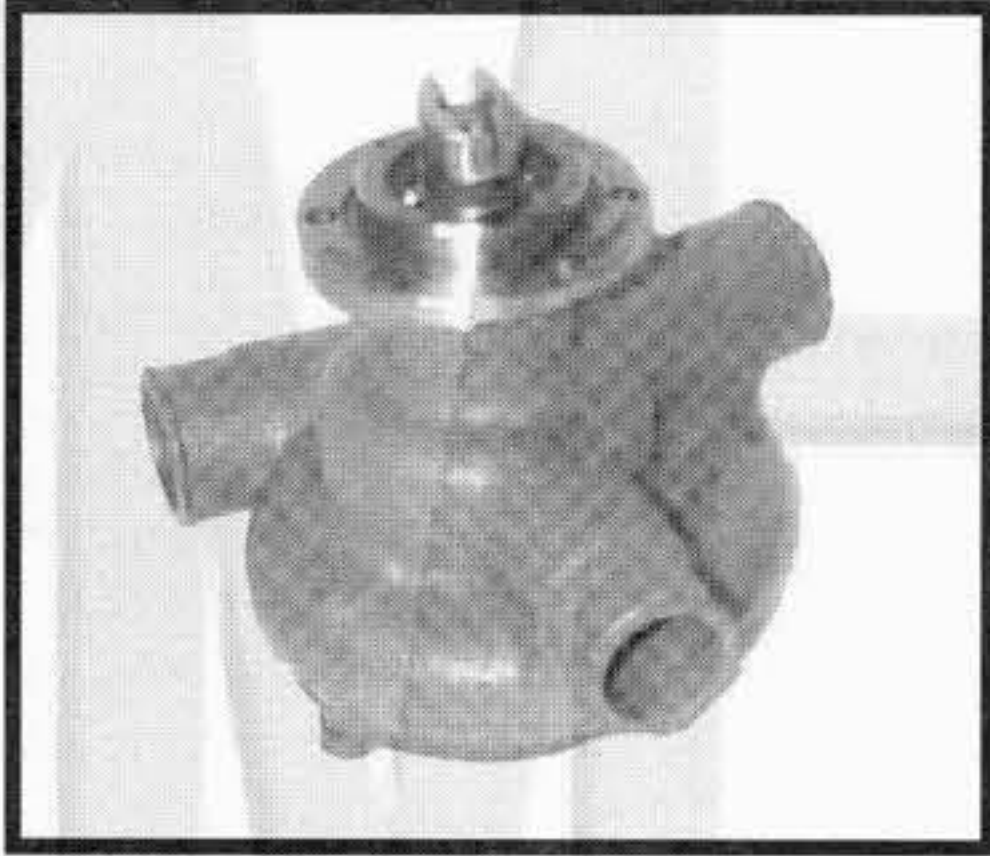
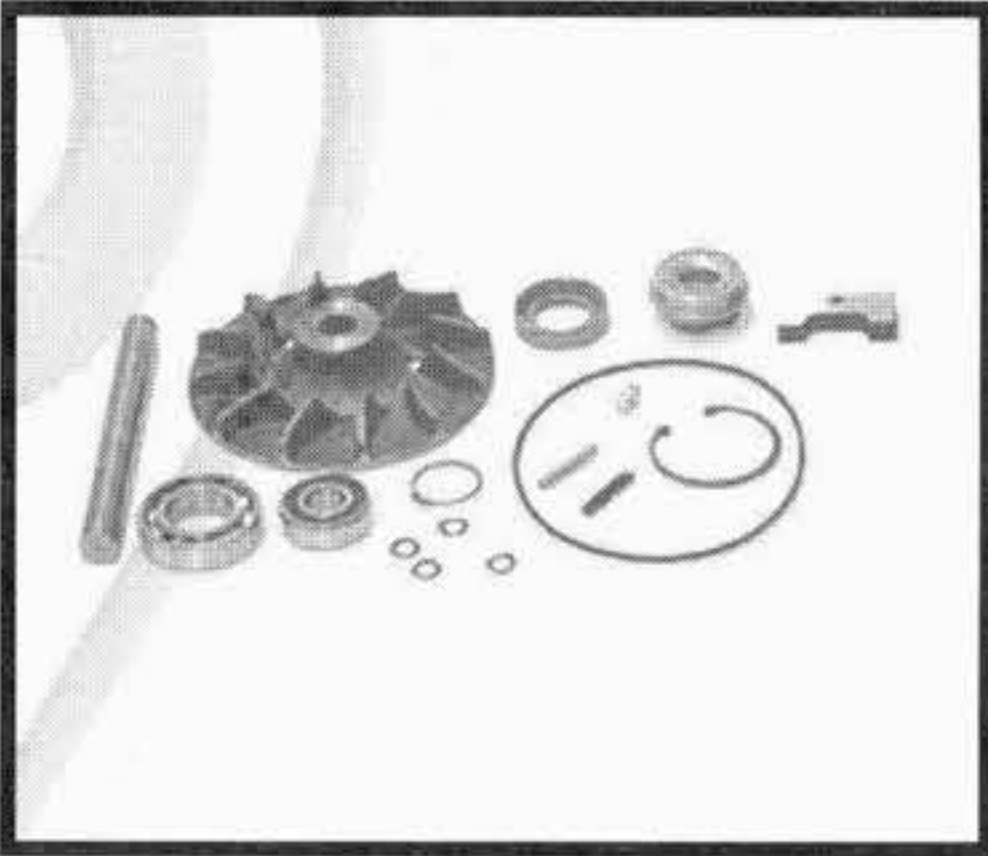
www.spwaterpumps.co.uk

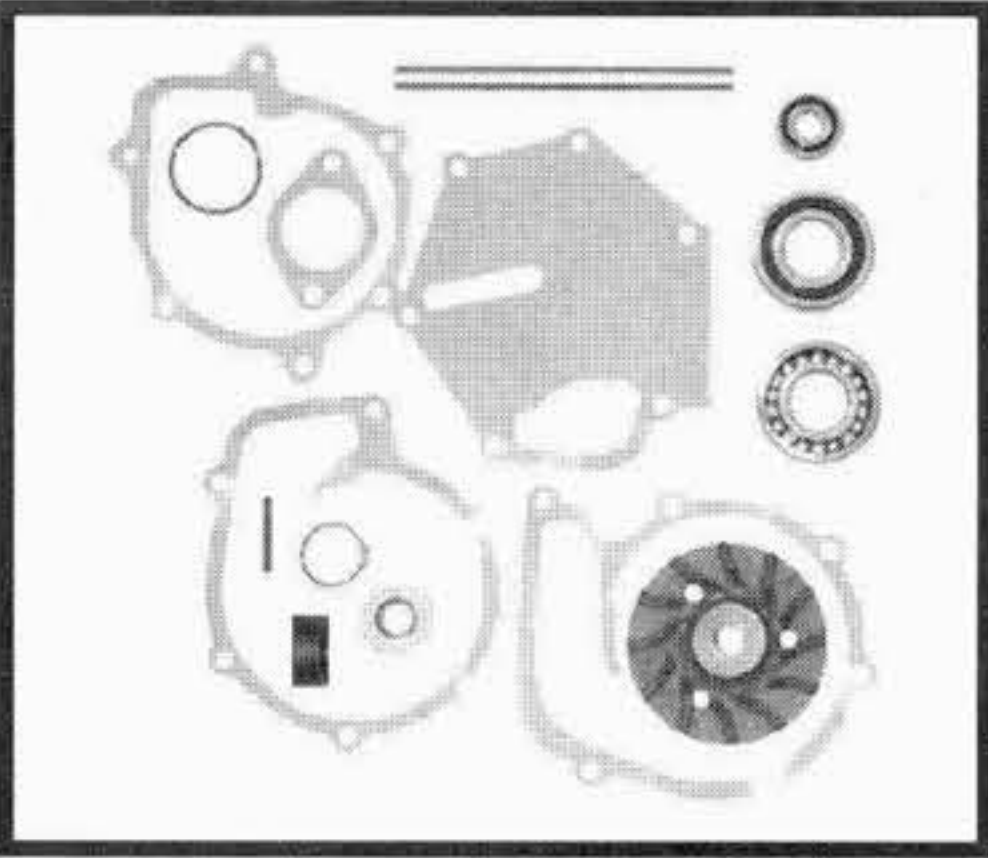

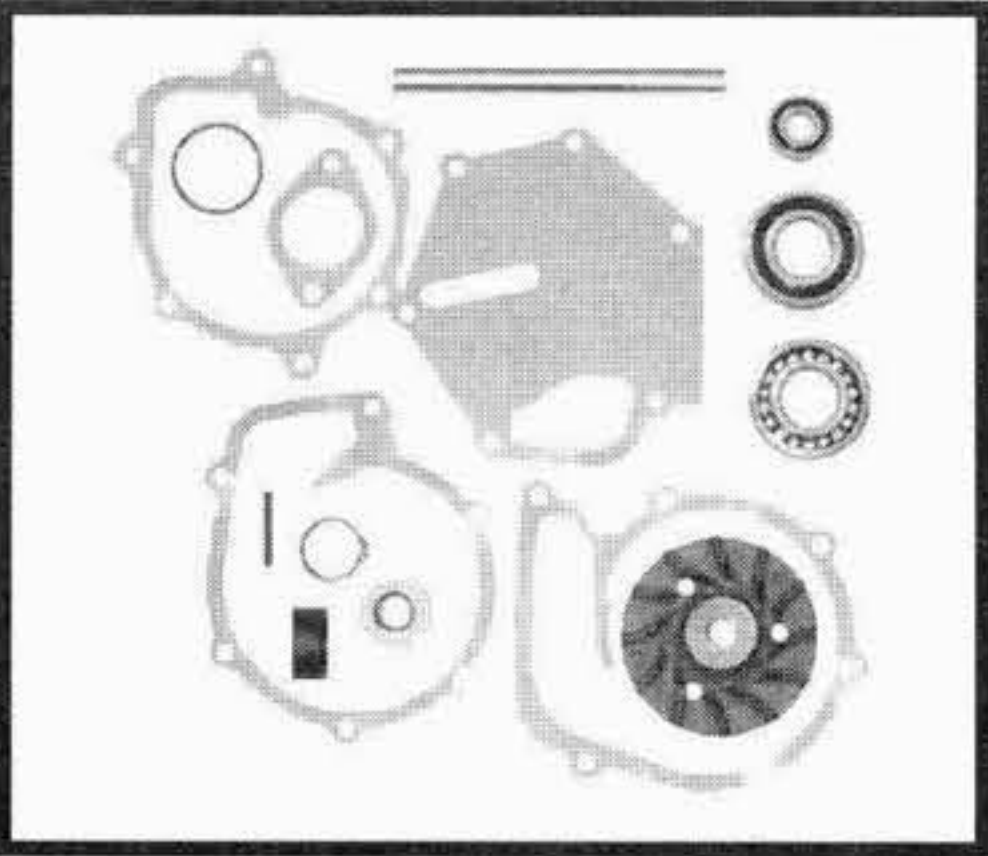
TIPO O MODELLO TYPE OU MODELE TYPE OR MODEL	MOTORE MOTEUR ENGINE	POMPA ACQUA POMPE A EAU WATER PUMP	KIT RIPARAZIONE NECESSAIRE DE REP. REPAIR KIT
B 57	TD 70 F TD 70 FC TD 70 FS TD 70 F USA TD 70 G	<p>317.000 1699.784</p> 	<p>312.275 276.806</p>  <p>in alternativa / alternatively use 312.170 275.607</p>
B 58 B 59 B 9 M B 10 M B 10 R	HD 100 A THD 100 AD	<p>317.080 1699.781</p> 	<p>312.286 3097.204</p>  <p>n alternativa / alternatively use 312.173 275.609</p>
B 6	D 60 TD 60 A TD 60 B TD 60 C TD 60 A USA TD 60 B USA	<p>317.040 465.242</p> 	<p>312.275 276.806</p>  <p>in alternativa / alternatively use 312.170 275.607</p>
B 6	TD 60 A TD 60 B	<p>317.110 1699.783</p> 	<p>312.275 276.806</p>  <p>in alternativa / alternatively use 312.170 275.607</p>

I ricambi non sono originali ma adattabili . Ogni riferimento originale é assolutamente indicativo .
Spare parts are not original but perfectly suitable . Every original part number has to be considered for reference purpose only .

SUITABLE





VOLVO

AUTOBUS - AUTOCARS - BUSES - OMNIBUSSE

Tel:+44(0)1925 850082 Fax: +(0)44 1925 850083

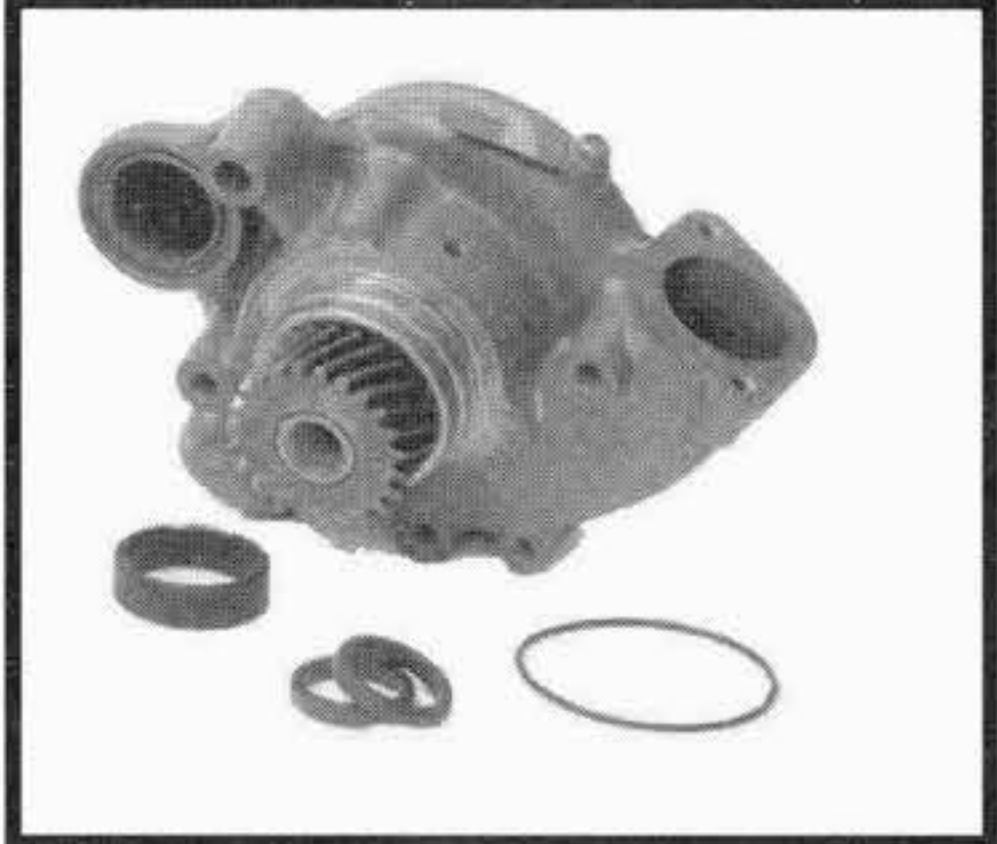
www.spwaterpumps.co.uk

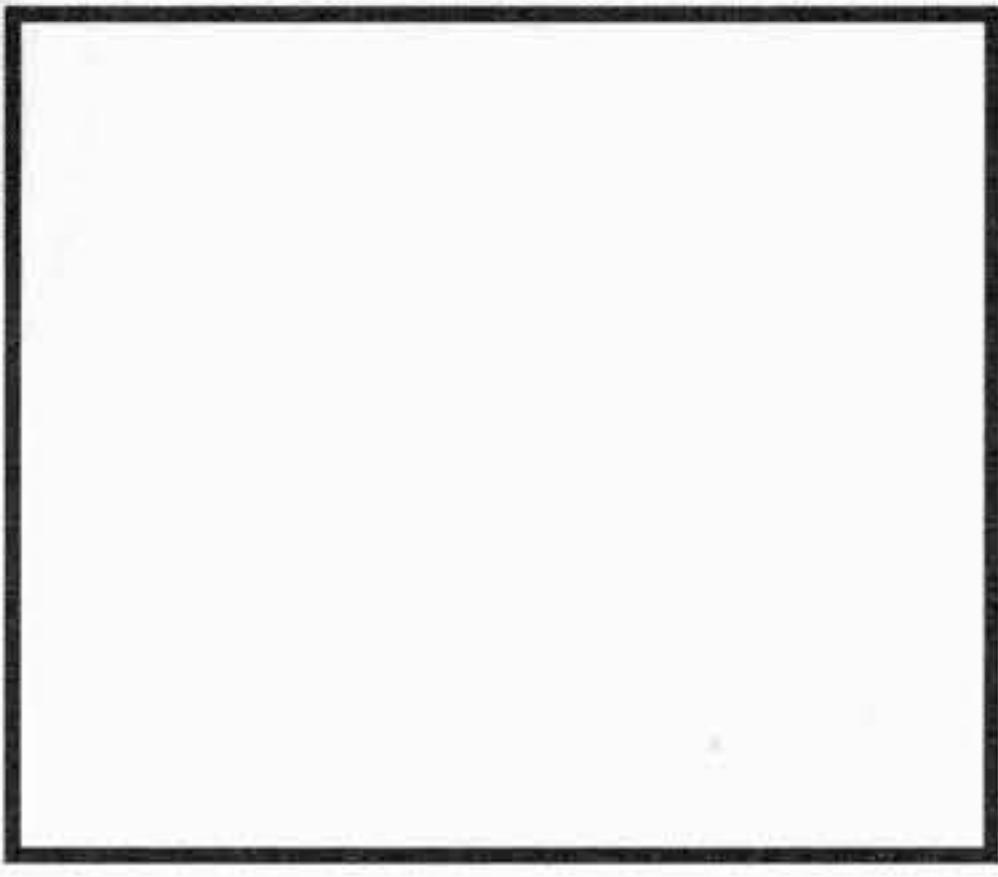

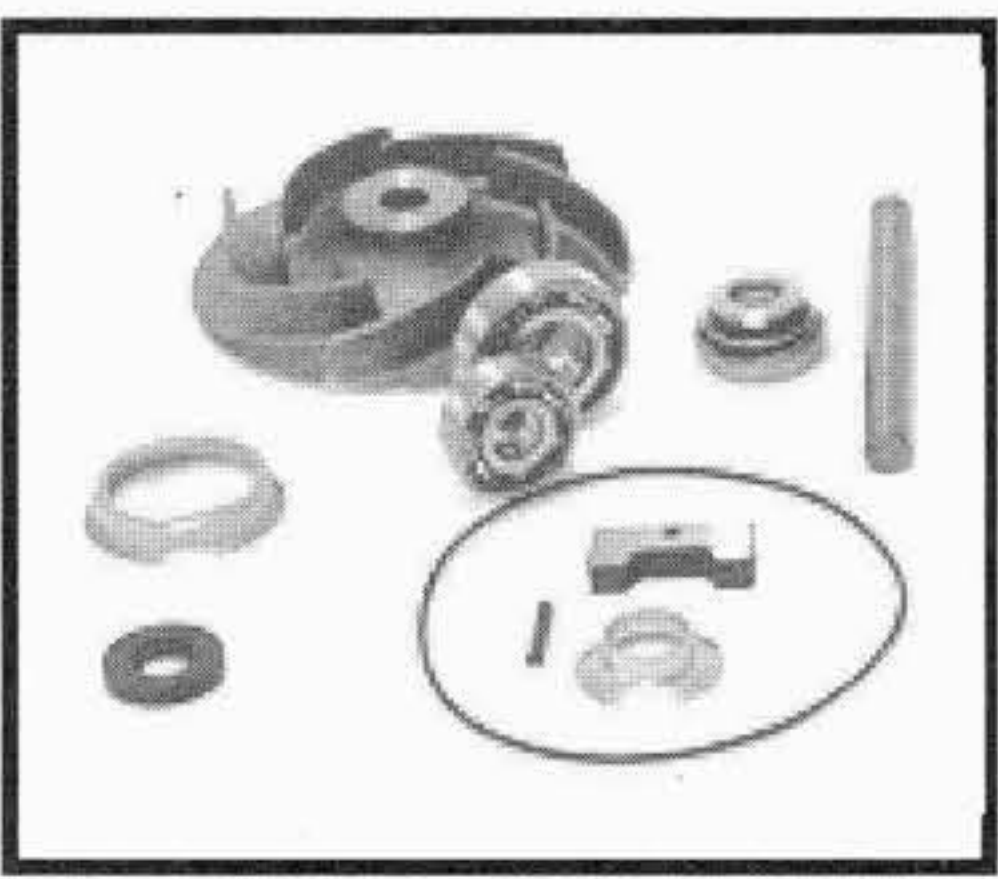
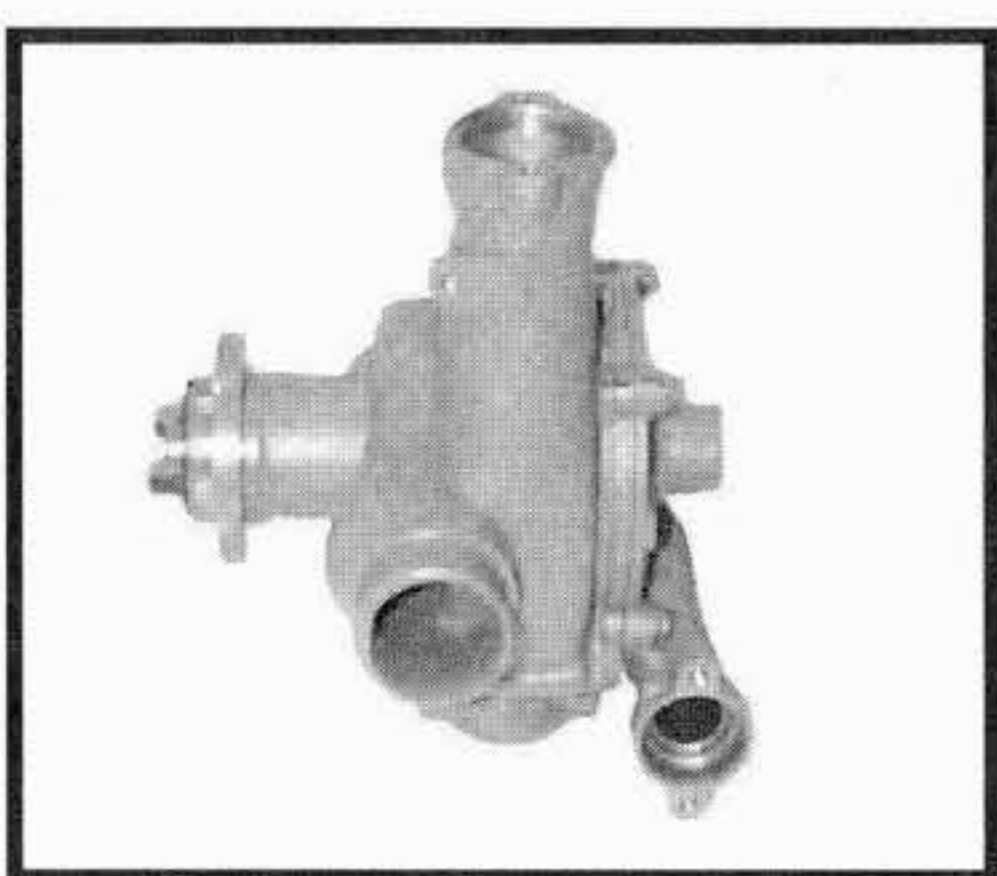
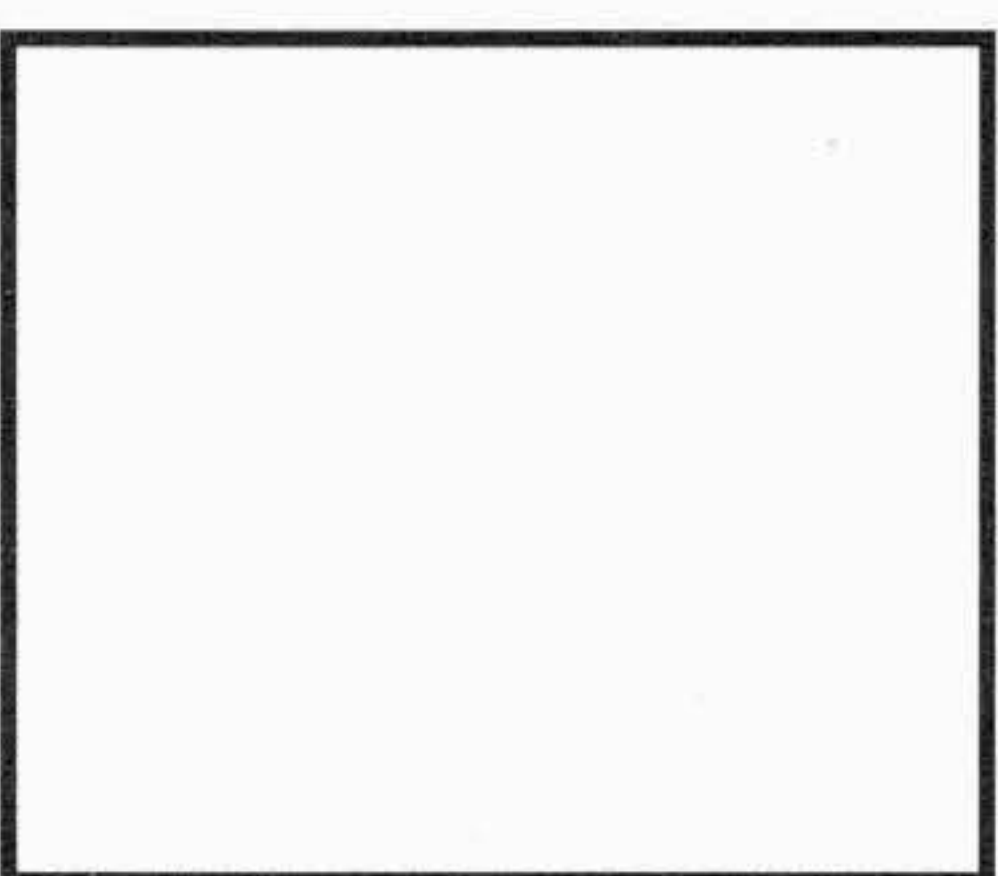
TIPO O MODELLO TYPE OU MODELE TYPE OR MODEL	MOTORE MOTEUR ENGINE	POMPA ACQUA POMPE A EAU WATER PUMP	KIT RIPARAZIONE NECESSAIRE DE REP. REPAIR KIT
<p>B 6</p> <p>B 6 Excellence 1000 Midi</p> <p>B 6 Midi</p> <p>B 6 - SN9</p> <hr/> <p>B 7 dal telaio n° 30000 ---></p> <p>317.350 - FM7 Buses B6, B7, B7L, B7R. TD73 High Output</p>	<p>TD 63 E</p> <p>D 6</p> <p>TD 73</p>	<p>317.175 8192.050</p>  <p>High Output Version 317.350 - FM7, B7L etc</p>	<p>312.277 276.835</p> 
<p>B 9 M</p> <p>B 10 M --> fino al telaio 20000</p> <p>B 10 R</p> <p>C 10 M</p>	<p>THD 101 G --> mot. 50984 THD 101 K</p>	<p>--- 469.744</p> <div style="border: 1px solid black; padding: 10px; text-align: center;"> <p>SOST. DA : / REPLACE BY :</p> <p>317.180 425.308</p> </div>	<p>312.174 275.623</p> 
<p>B 9 M</p> <p>B 10 M --> fino al telaio 20000</p> <p>B 10 R</p> <p>B 10 B</p> <p>C 10 M</p> <p>B 10 M dal telaio 20001 ---></p> <p>B 10 R</p>	<p>THD 101 G mot. 50985 ---> THD 101 K</p> <p>THD 101 G</p>	<p>317.180 425.308</p> 	<p>312.287 3097.203</p> 
<p>B 9 M</p> <p>B 10 B</p> <p>B 10 M dal telaio 20001 ---></p> <p>B 10 R</p> <p>C 10 M</p> <p>NEW !!</p>	<p>THD 101 KE</p>	<p>317.280 425.267</p> 	<p>312.294 3097.084</p> 

I ricambi non sono originali ma adattabili . Ogni riferimento originale é assolutamente indicativo .
Spare parts are not original but perfectly suitable . Every original part number has to be considered for reference purpose only .

SUITABLE



VOLVO

AUTOBUS - AUTOCARS - BUSES - OMNIBUSSE

Tel:+44(0)1925 850082 Fax: +(0)44 1925 850083

www.spwaterpumps.co.uk

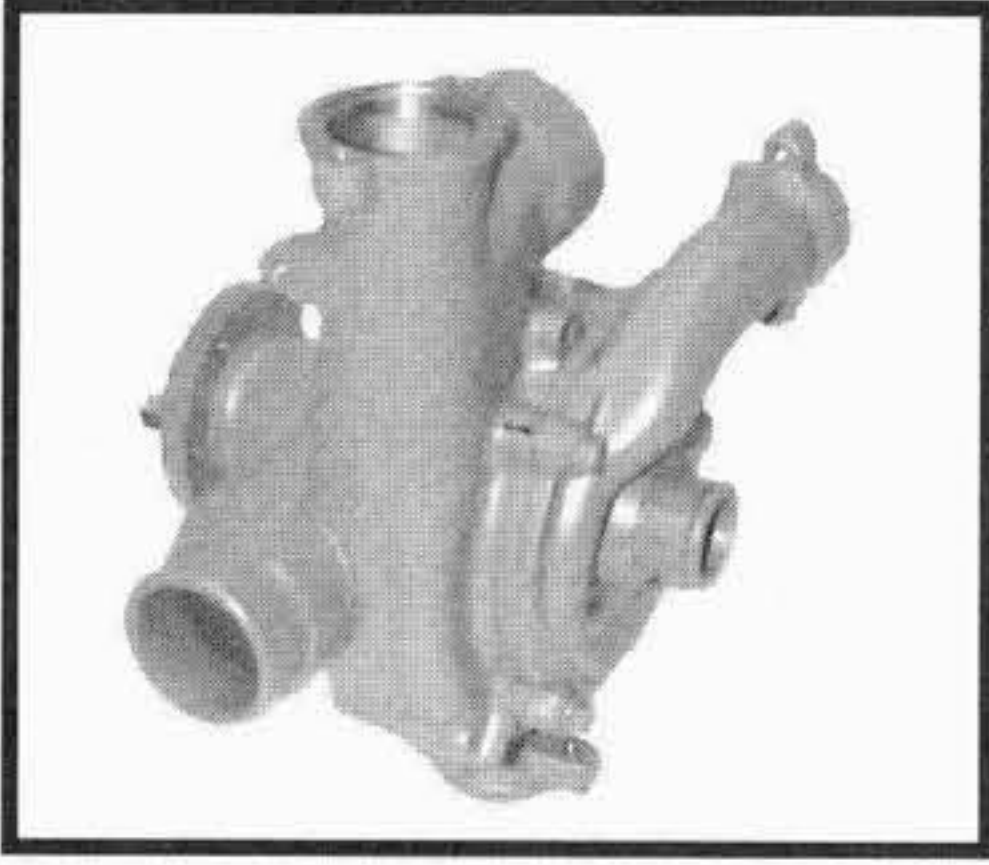
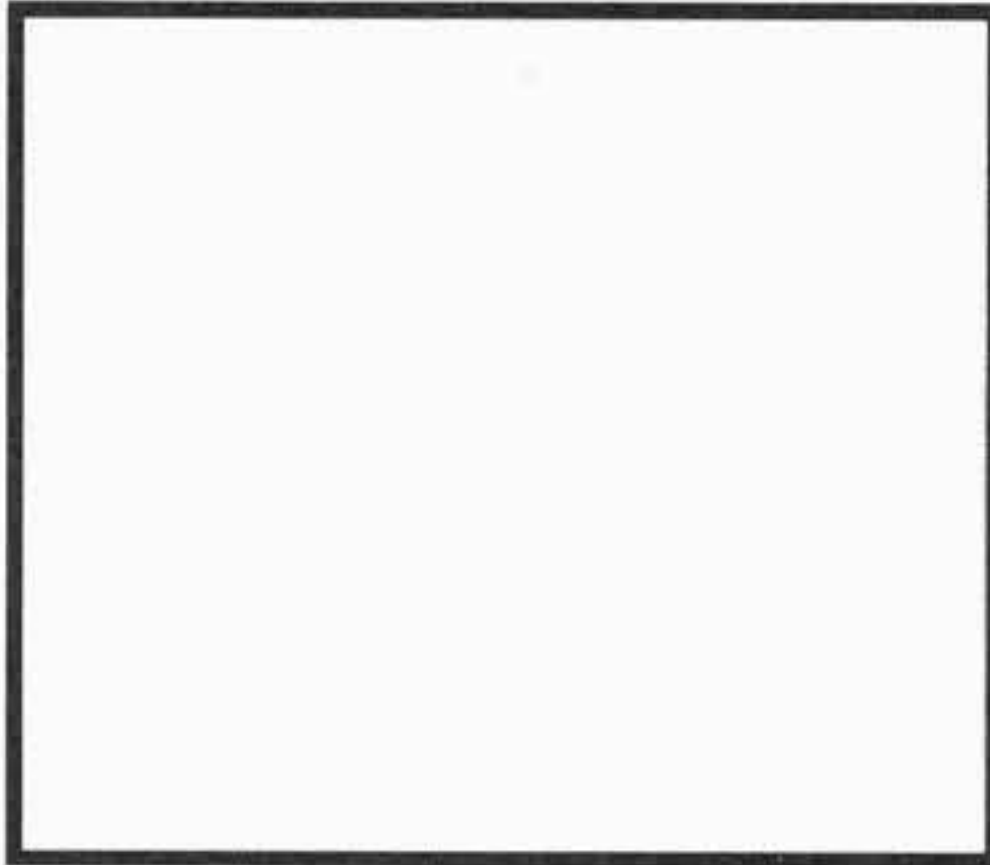
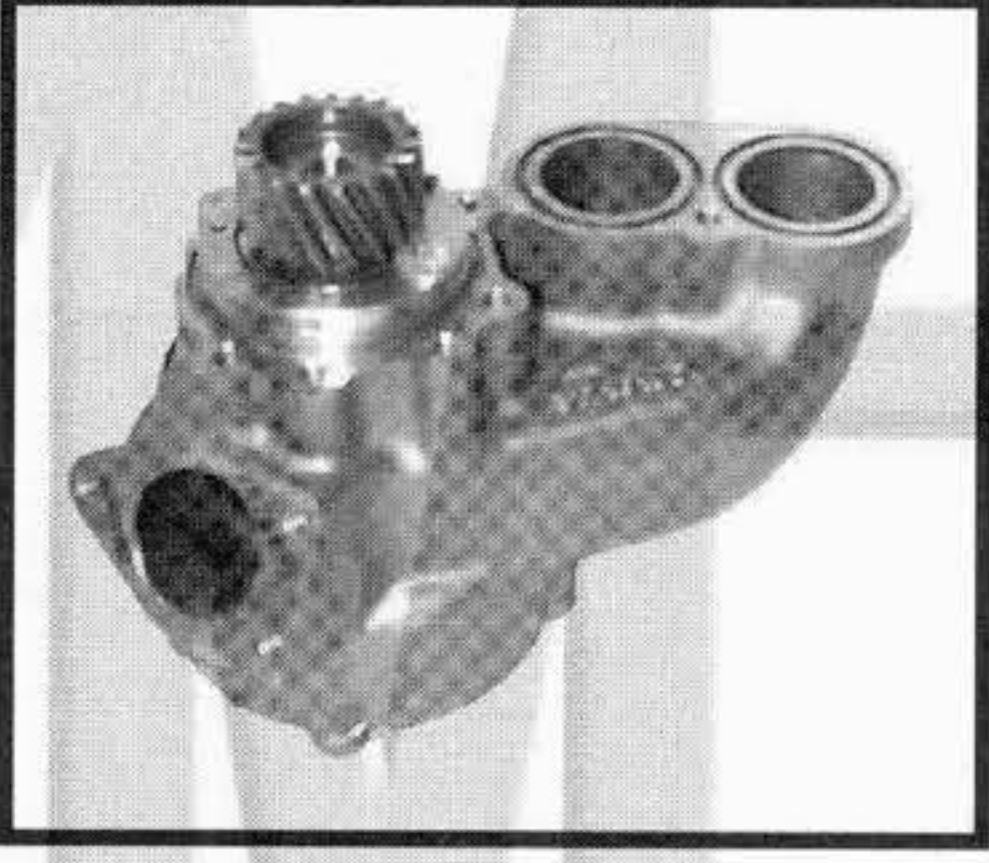
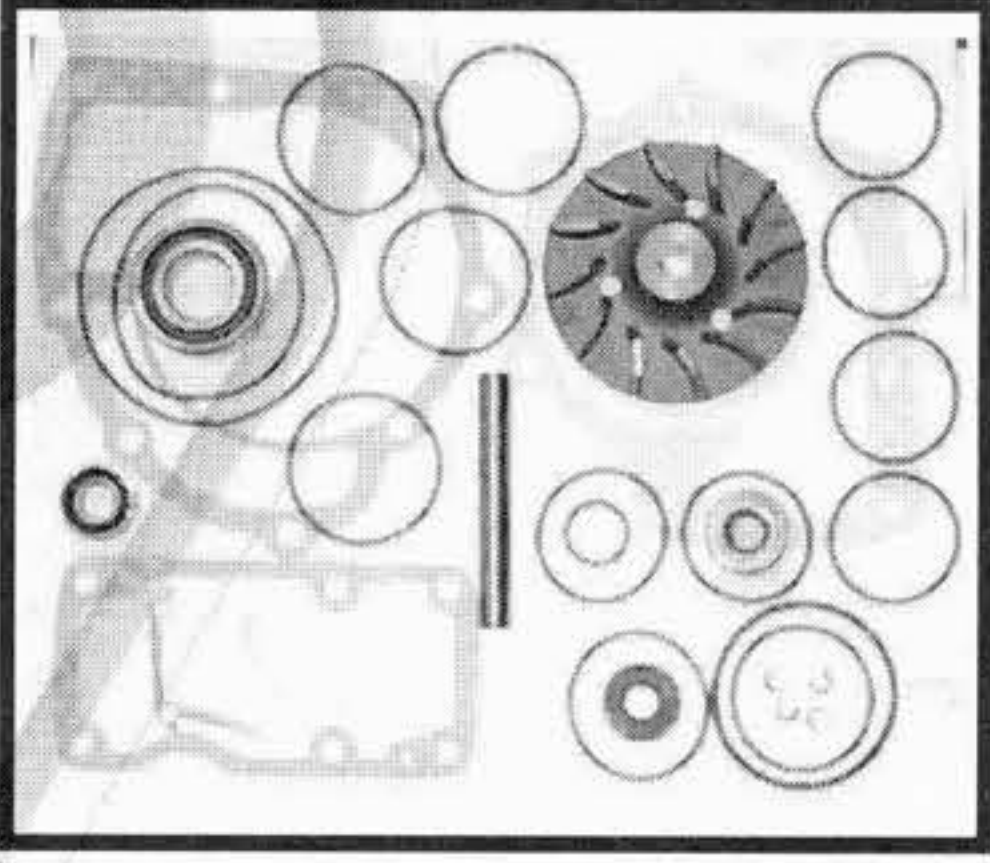
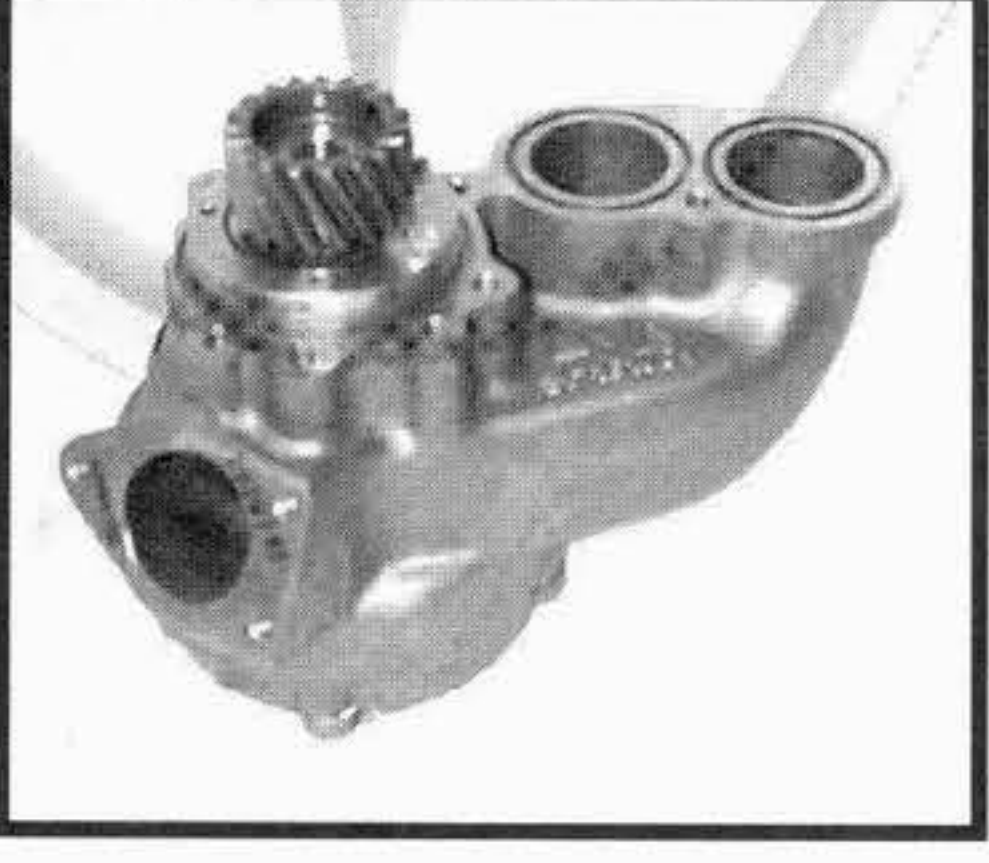

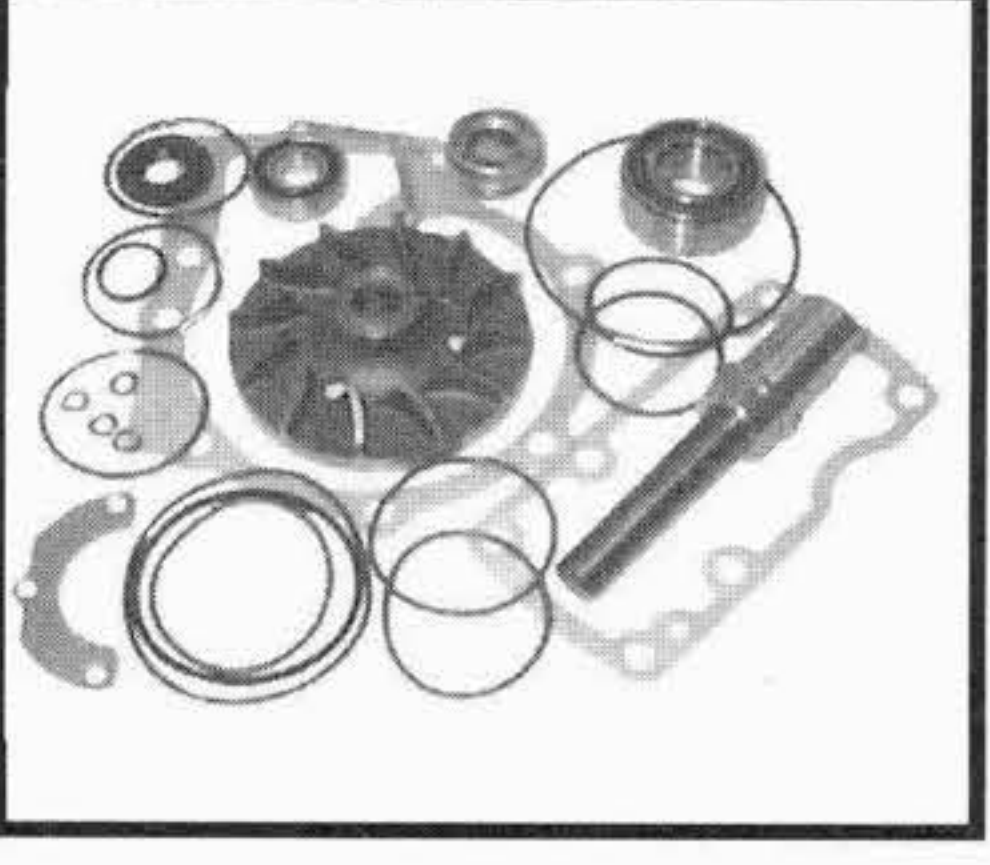
TIPO O MODELLO TYPE OU MODELE TYPE OR MODEL	MOTORE MOTEUR ENGINE	POMPA ACQUA POMPE A EAU WATER PUMP	KIT RIPARAZIONE NECESSAIRE DE REP. REPAIR KIT
		OMP REF. / O.EM. REF	OMP REF. / O.EM. REF
<p>B 10 B - SFL 12</p> <p>B 10 B Excellence 1000 / L / Shuttle</p> <p>B 10 B - SL 12</p> <p>B 10 M MK III</p> <p>B 10 R</p> <p>B 10 L</p> <p>C 10 M</p> <p>NEW !!</p>	<p>THD 102 KB</p> <p>THD 102 KD</p> <p>THD 102 KK</p> <p>THD 103 KB</p> <p>THD 103 KD</p> <p>THD 103 KF</p>	<p>317.290 425.268</p> 	<p>312.294 3097.084</p> 
<p>B 12</p> <p>Olympian Mk II</p>	<p>TD 120</p> <p>TD 121</p> <p>TD 122 FK</p> <p>TD 122 FS</p> <p>TD 122 FL</p> <p>TD 122 FH</p>	<p>317.160 1545.261</p> 	<p>312.276 276.802</p>  <p>in alternativa / alternatively use 312.171 275.615</p>
<p>B 12</p> <p>Olympian Mk II</p>	<p>TD 122 FK - OCS</p> <p>TD 122 FS - OCS</p> <p>TD 122 FL - OCS</p> <p>TD 122 FH - OCS</p>	<p>317.190 422.791</p> 	<p>312.175 270.791</p> 
<p>B 12 ---> fino al telaio N° 4999</p> <p>Olympian Mk II</p> <p>NEW !!</p>	<p>TD 123 E</p> <p>TD 123</p>	<p>317.240 1675.945</p> 	<p>312.278 276.814</p> 

I ricambi non sono originali ma adattabili . Ogni riferimento originale é assolutamente indicativo .
Spare parts are not original but perfectly suitable . Every original part number has to be considered for reference purpose only .

SUITABLE

VOLVO**AUTOCARRI - CAMIONS - TRUCKS - LKW****Tel:+44(0)1925 850082 Fax: +(0)44 1925 850083****www.spwaterpumps.co.uk****SP**
WATER PUMPS

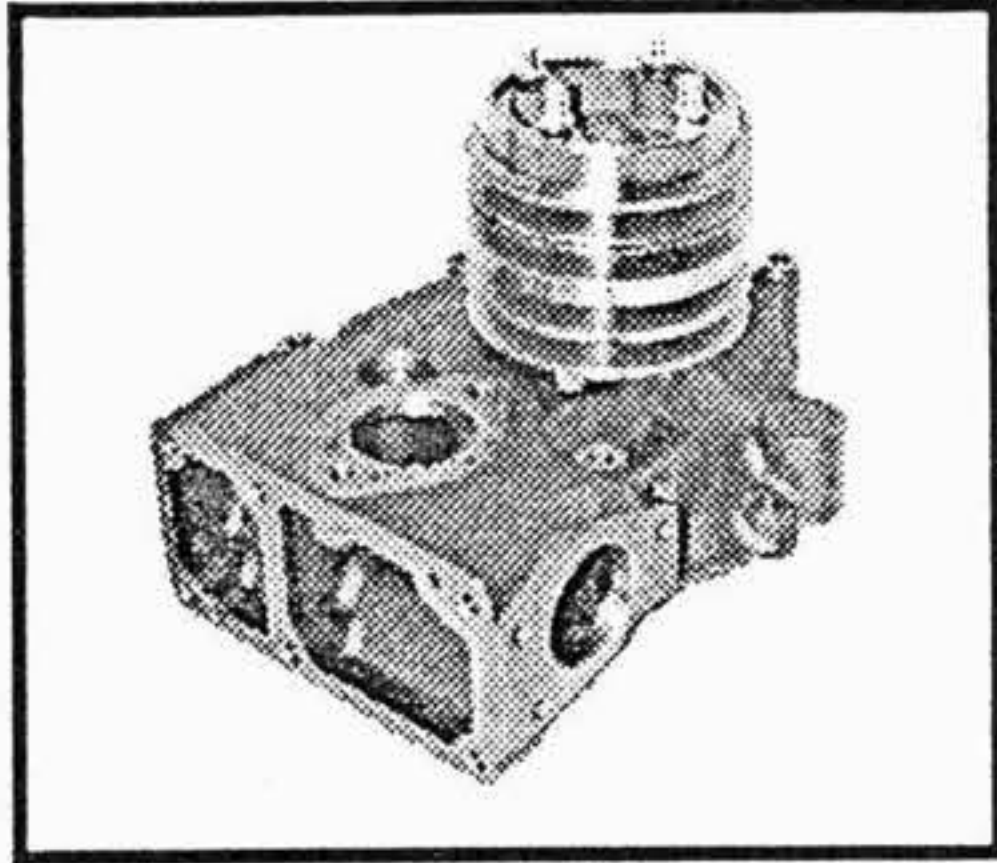
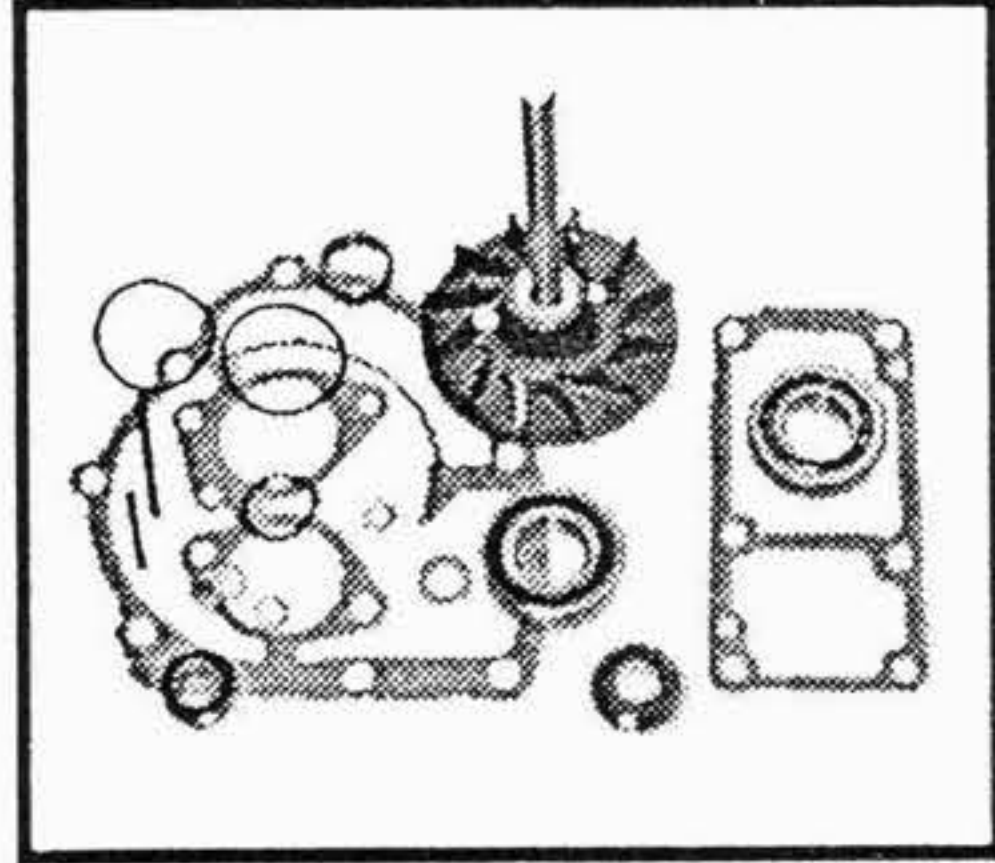
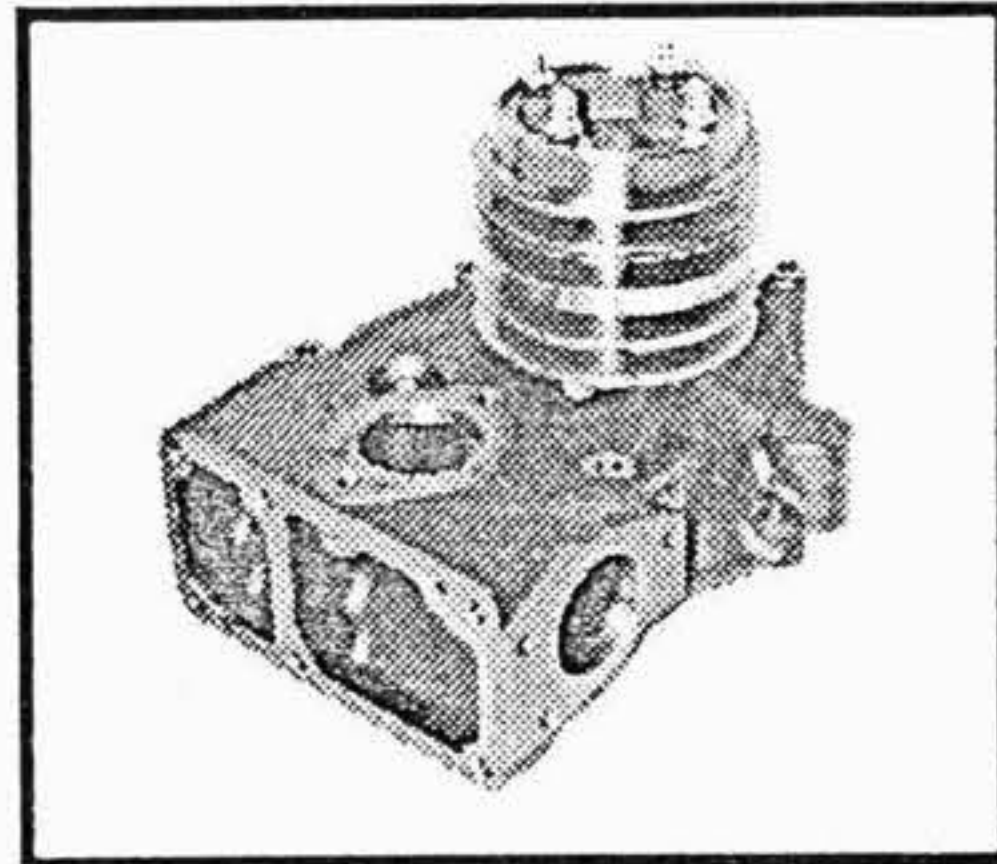
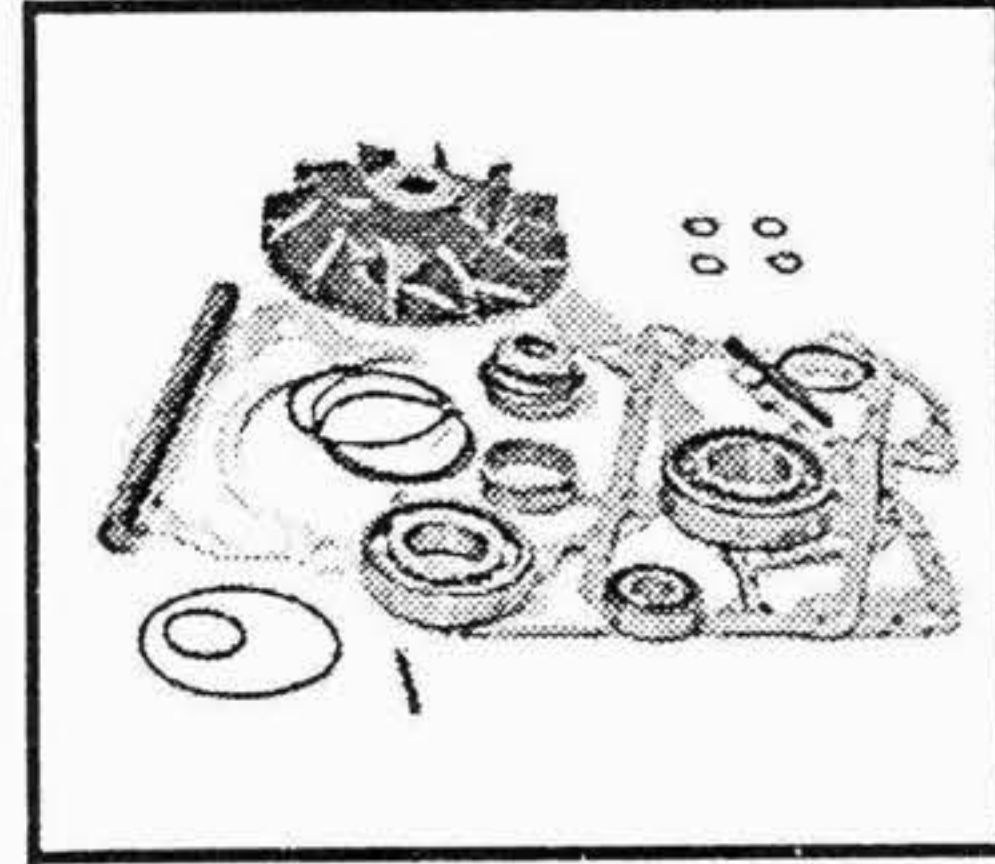
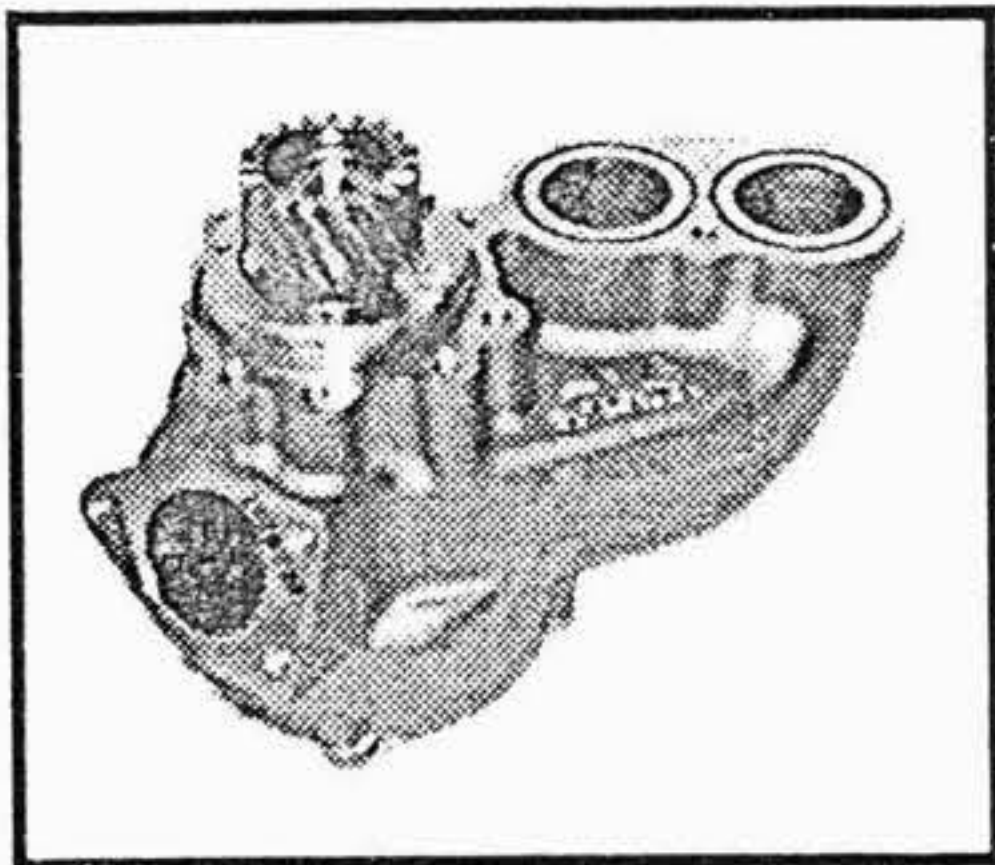
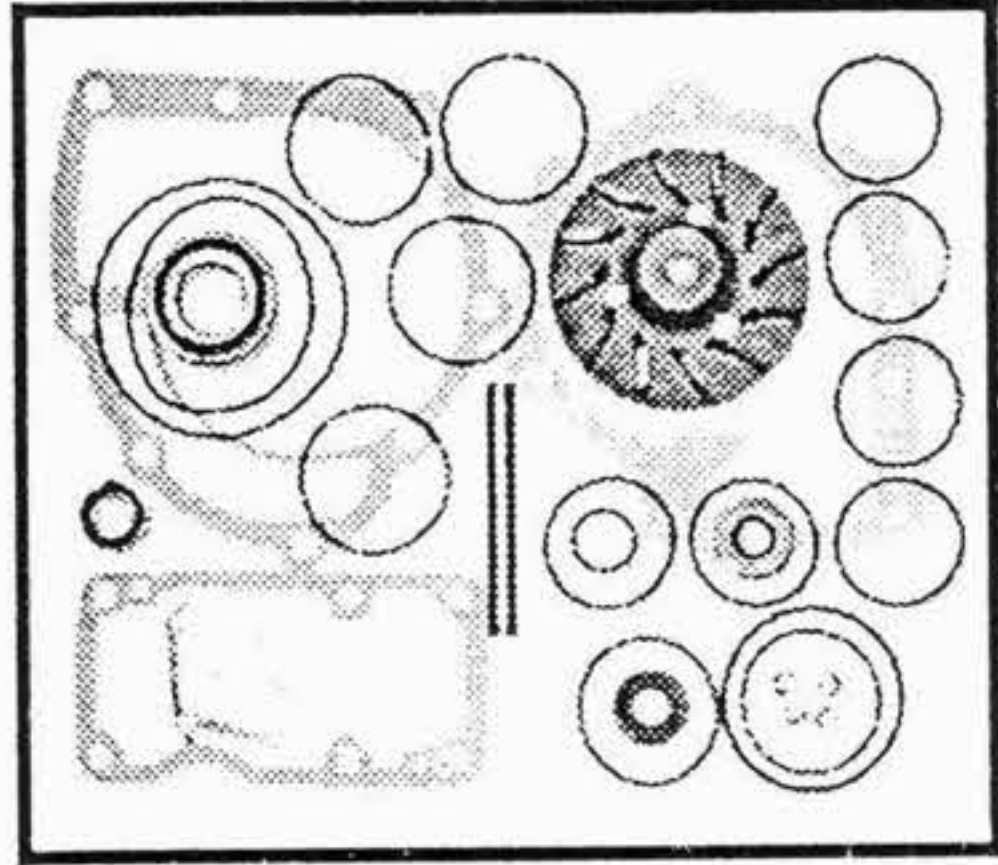
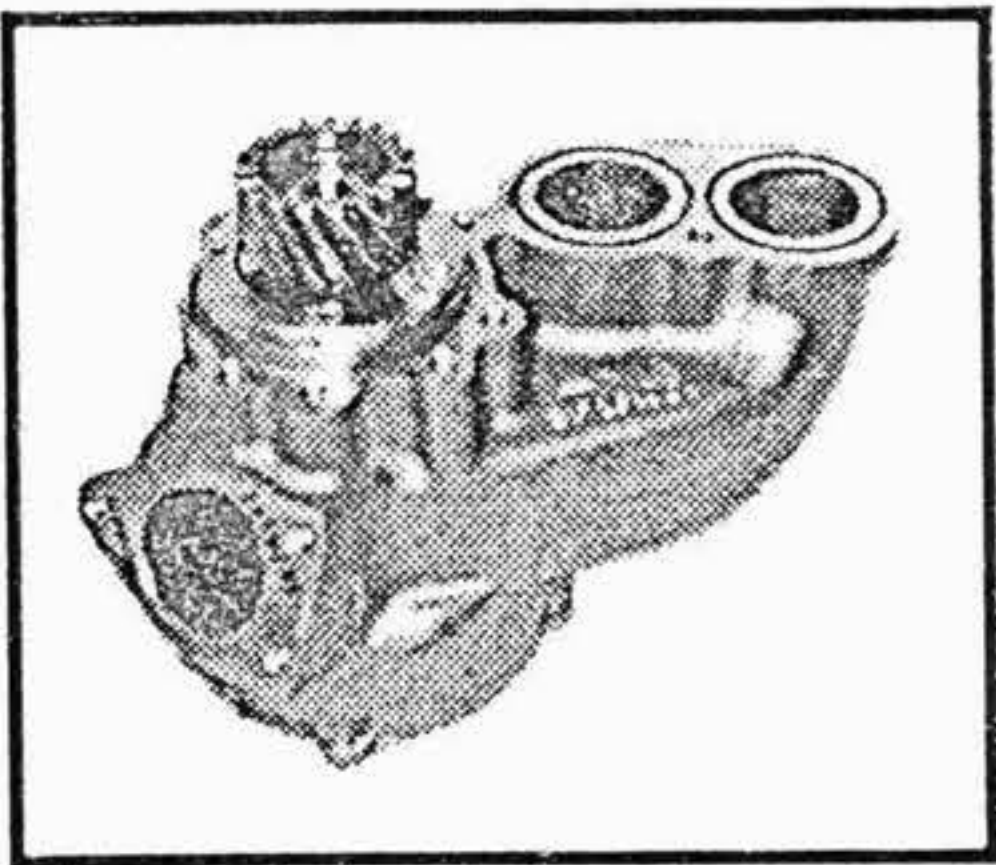
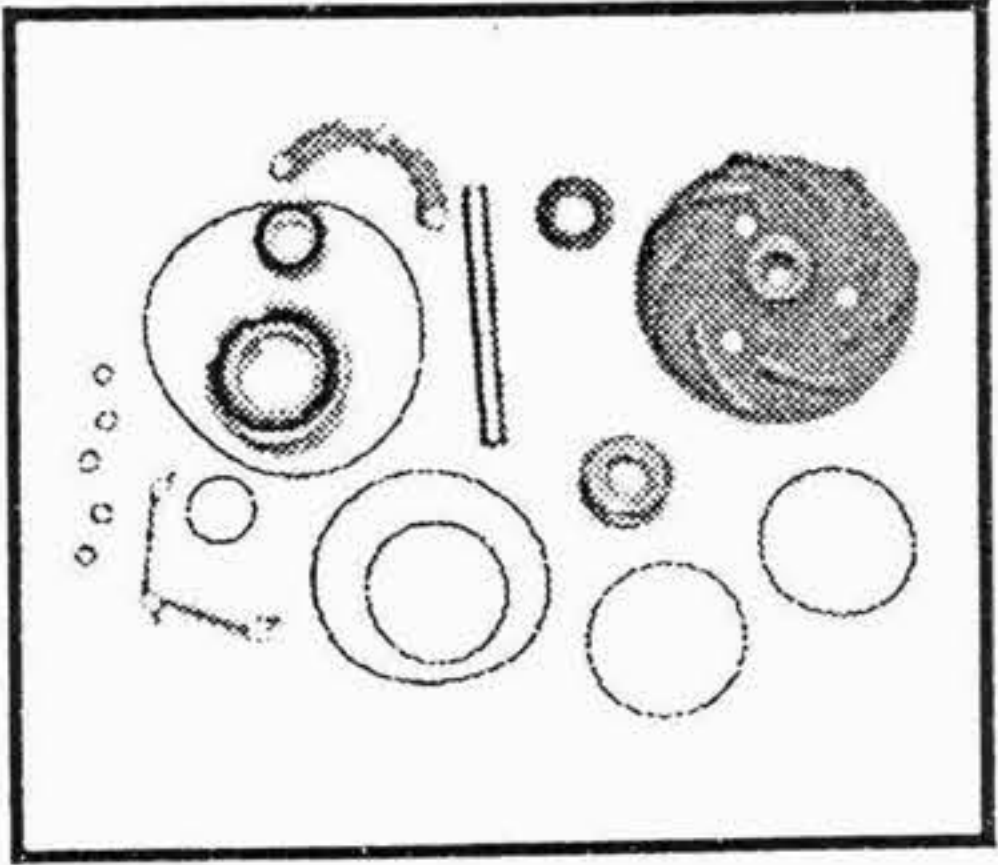
TIPO O MODELLO TYPE OU MODELE TYPE OR MODEL	MOTORE MOTEUR ENGINE	POMPA ACQUA POMPE A EAU WATER PUMP	OMP REF. / O.E.M. REF	KIT RIPARAZIONE NECESSAIRE DE REP. REPAIR KIT	OMP REF. / O.E.M. REF
N 10 dal telaio 304000 --->	TD 101 USA		317.195 1545.427		312.178 275.986
NL 10 S dal telaio 304000 --->	TD 101 USA				
N 10 MARK II dal telaio 304000 -->	TD 101 USA	ad esaurimento sost. da / will be supersided by 317.225 1699.789		in alternativa / alternatively use 312.285 276.800	
N 10 dal telaio 304000 --->	TD 101 USA		317.225 1699.789		312.285 276.800
NL 10 - NL 10 S dal telaio 304000 --->	TD 101 USA				
N 10 MARK II dal telaio 304000 -->	TD 101 USA			in alternativa / alternatively use 312.172 275.618	
F 10 dal telaio 25001 ---> FL 10 INTERCOOLER 320 FL 10 FS 10 F 12 ---> fino al telaio 34000 F 12 dal telaio 34001 ---> F 12 INTERCOOLER 360 dal telaio 314000 ---> F 12 INTERCOOLER 420 N 12 ---> fino al telaio 12000 N 12 dal telaio 12001 ---> NL 10 S NL 12 - NL 12 S	TD 101 F TD 102 F TD 101 F TD 102 F TD 120 C/D/E/F/G/GA TD 121 F/FD/G/GD TD 122 FK / FS TD 120 A/E/G/GA TD 121 F/G/GA TD 121 GA TD 122 FK / FS		317.160 1545.261		312.276 276.802
F 10 INTERCOOLER 320	TD 102 F - OCS				
F 12 INTERCOOLER 360	TD 122 FK/FS-OCS				
F 12 INTERCOOLER 420	TD 122 FK/FS-OCS		317.190 422.791		312.175 270.791

I ricambi non sono originali ma adattabili . Ogni riferimento originale é assolutamente indicativo .
Spare parts are not original but perfectly suitable . Every original part number has to be considered for reference purpose only .

SUITABLE

VOLVO

AUTOCARRI - CAMIONS - TRUCKS - LKW
Tel:+44(0)1925 850082 Fax: +(0)44 1925 850083
www.spwaterpumps.co.uk

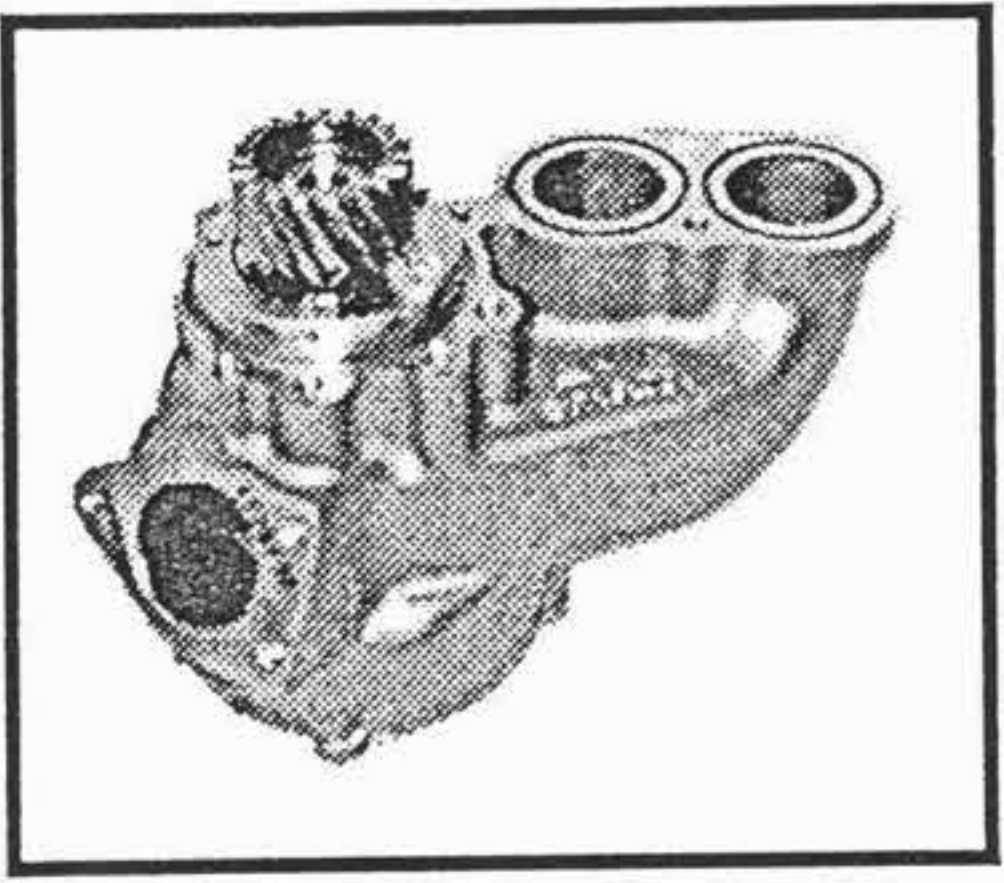
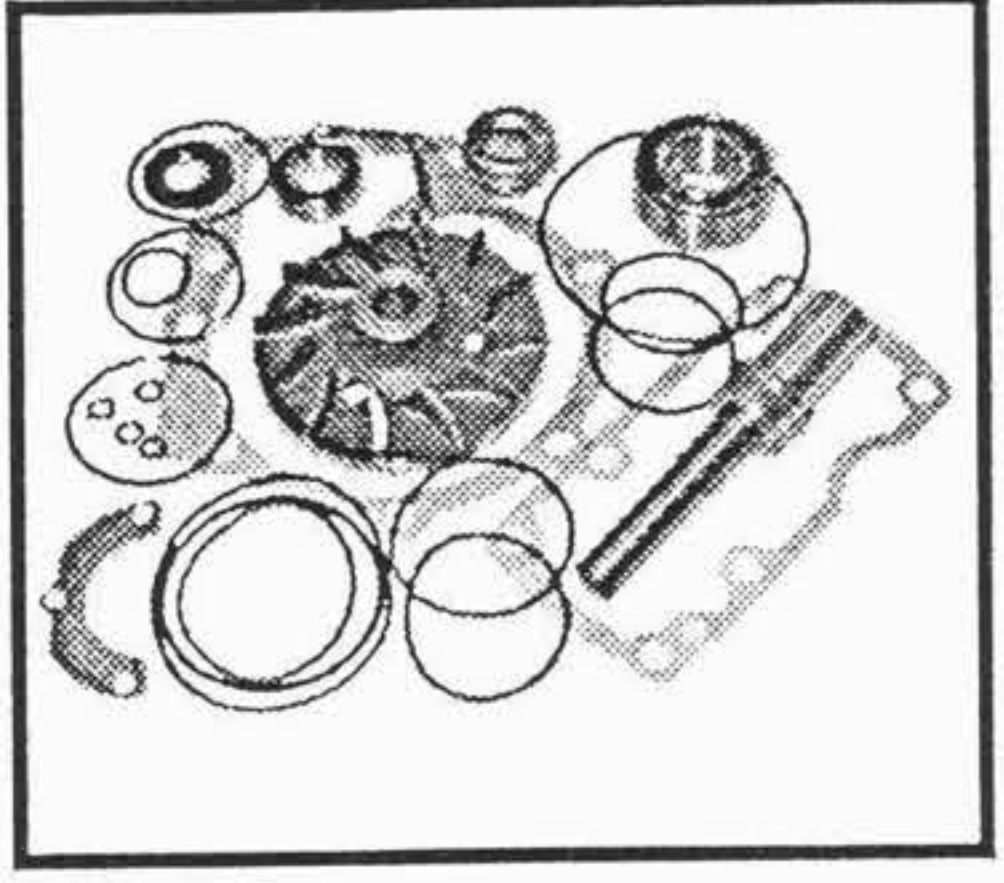
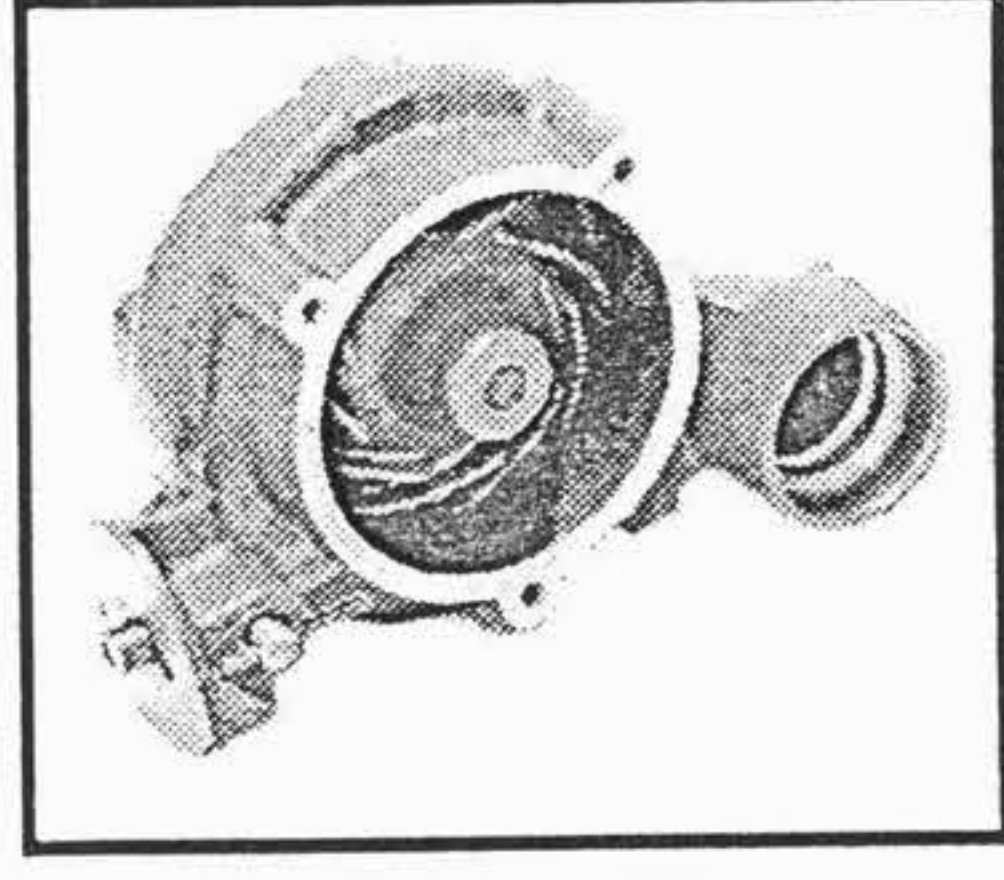
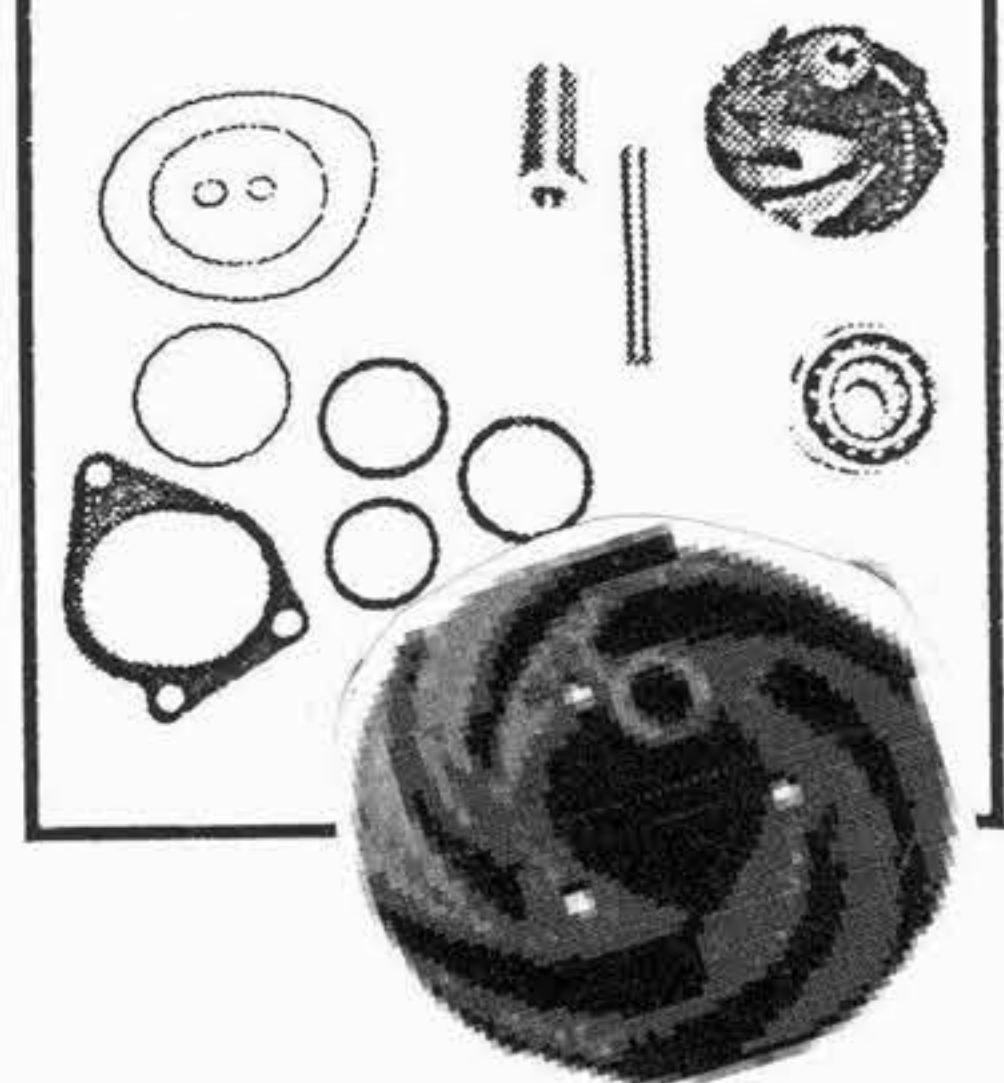
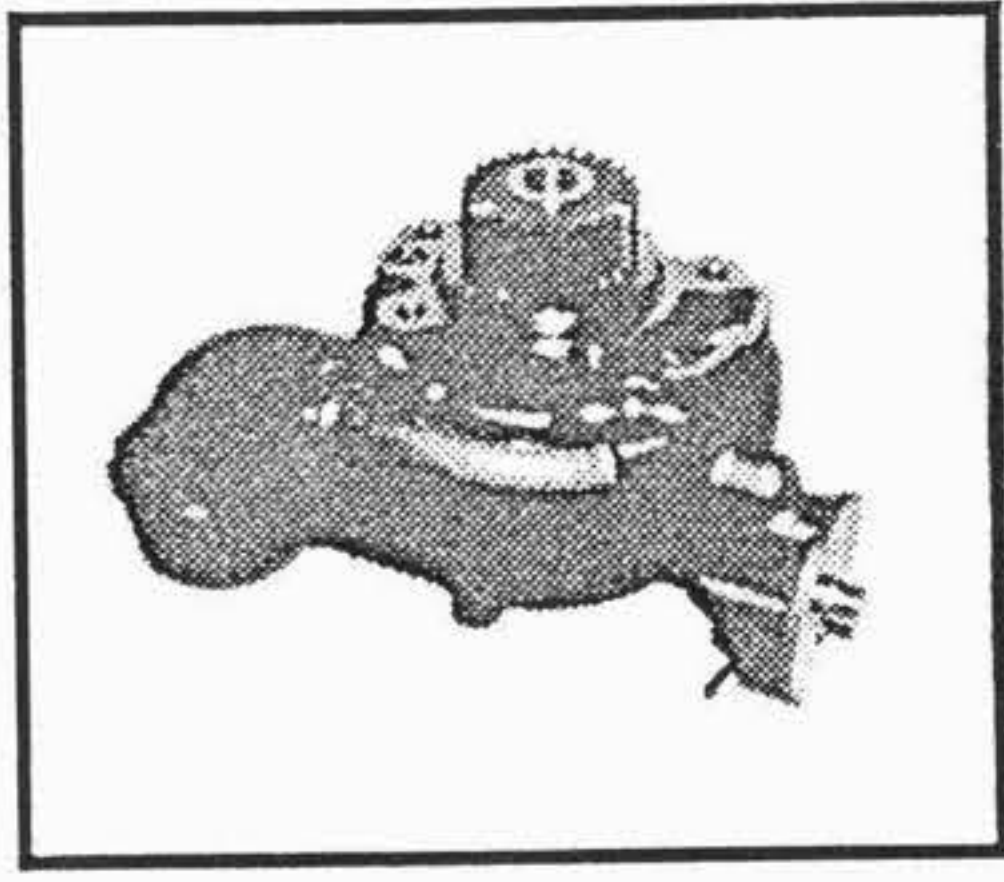
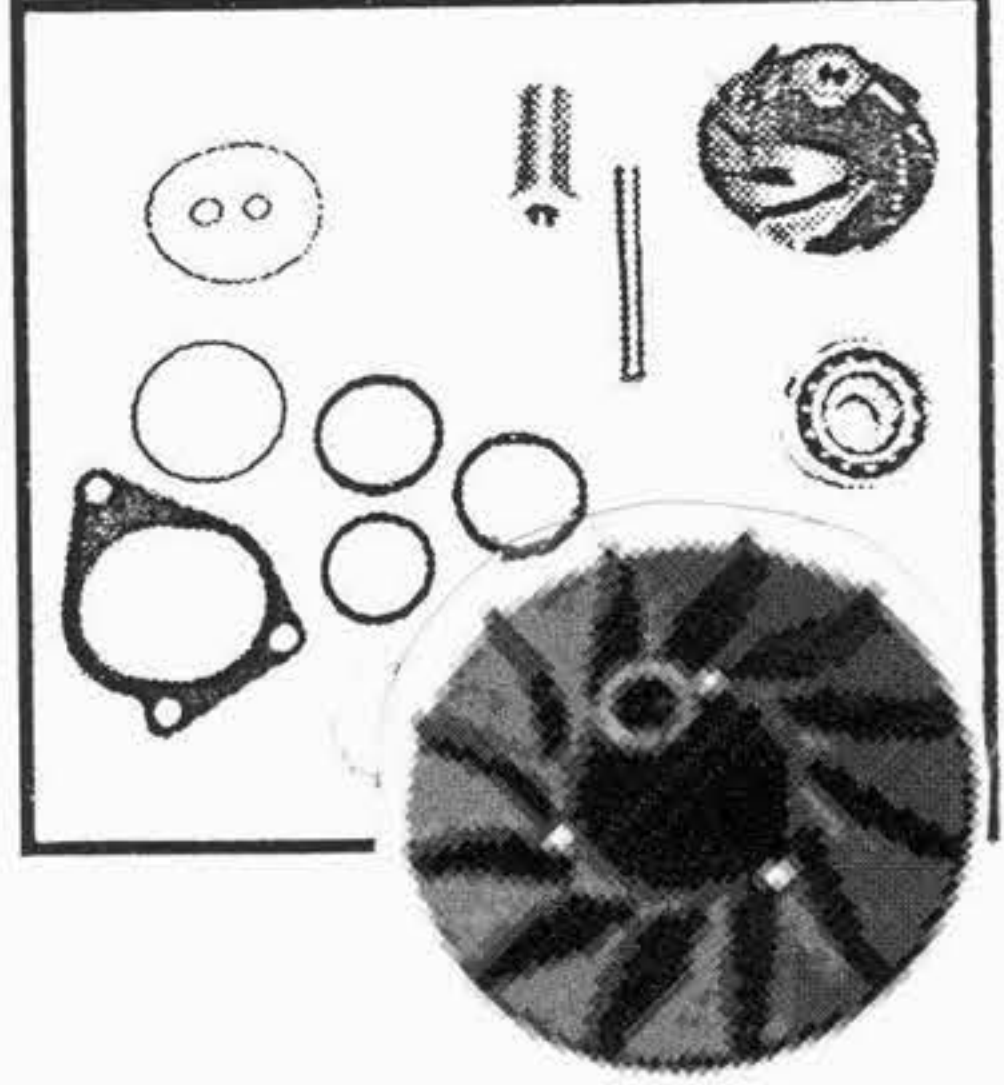
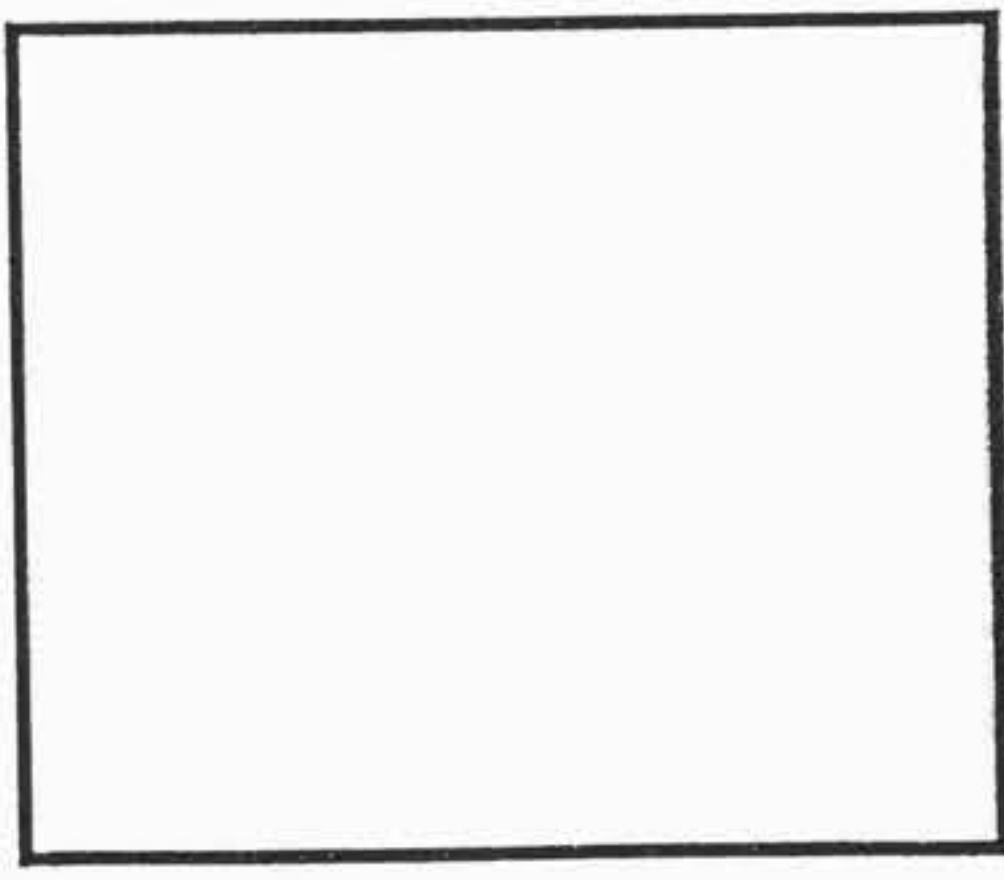
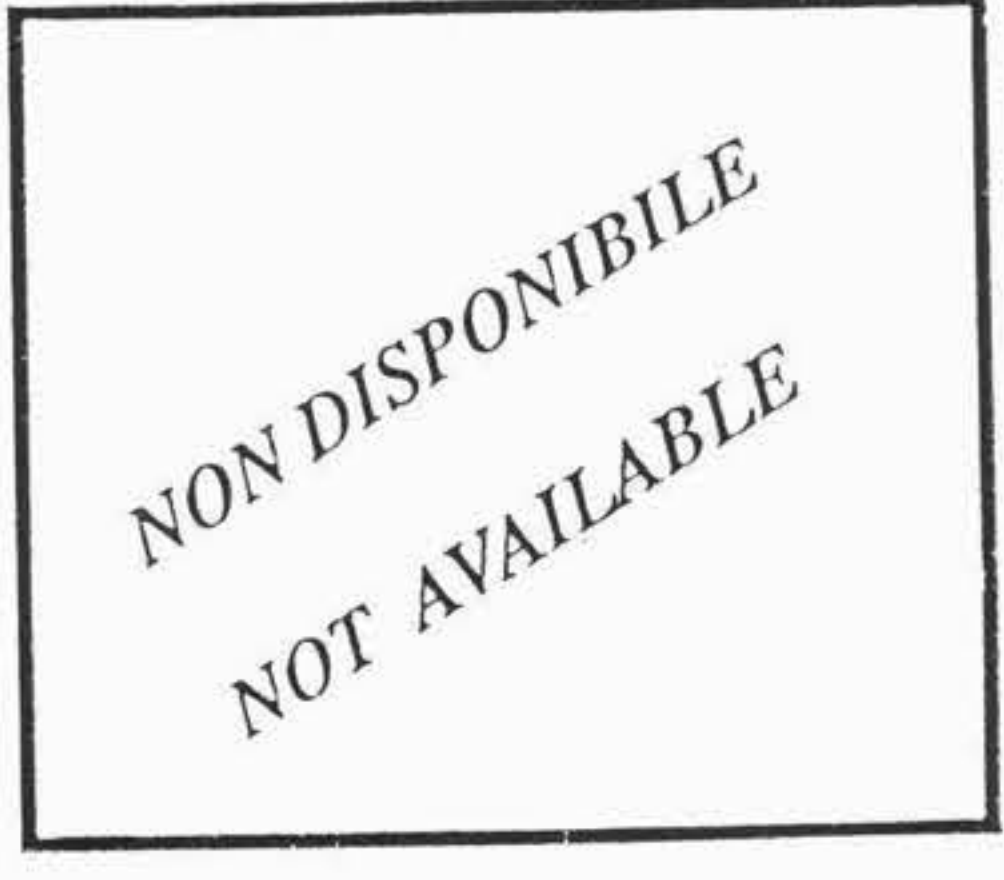

TIPO O MODELLO TYPE OU MODELE TYPE OR MODEL	MOTORE MOTEUR ENGINE	POMPA ACQUA POMPE A EAU WATER PUMP	KIT RIPARAZIONE NECESSAIRE DE REP. REPAIR KIT
F 10 dal telaio 314000 ---> FL 10 FS 10 F 12 FL 12 NL 10 NL 10 S NL 12 NL 12 S	TD 102 TD 103 E TD 103 ES TD 103 TD 123 E TD 123 E TD 123 ES	317.240 1675.945 	312.278 276.814 
FH 12 fino al telaio / up to chassis ---> 2911151 FL 10 FL 12 Per versioni con cambio manuale For vehicles with manual gearbox * Pour vehicules avec boîte de vitesse manuelle	D 12 A D 12 A D 12 A	317.250 8149.941 	312.291 276.121 
FH 12 fino al telaio / up to chassis ---> 2911151 FL 12 Per versioni con cambio automatico Per versioni con ritardatore VOITH For vehicles with automatic gearbox * For vehicles with VOITH hydraulic retarder	D 12 A 420 D 12 A 420 NEW !!	317.310 8149.882 	312.296 276.852 
FH 12 dal telaio / from chassis 2911152 ---> FM 12 Per versioni con cambio manuale For vehicles with manual gearbox	D 12 C D 12 C NEW !!	317.320 8170.305 	--- --- 

I ricambi non sono originali ma adattabili . Ogni riferimento originale é assolutamente indicativo .
 Spare parts are not original but perfectly suitable . Every original part number has to be considered for reference purpose only .

SUITABLE





VOLVO

AUTOCARRI - CAMIONS - TRUCKS - LKW

Tel:+44(0)1925 850082 Fax: +(0)44 1925 850083

www.spwaterpumps.co.uk

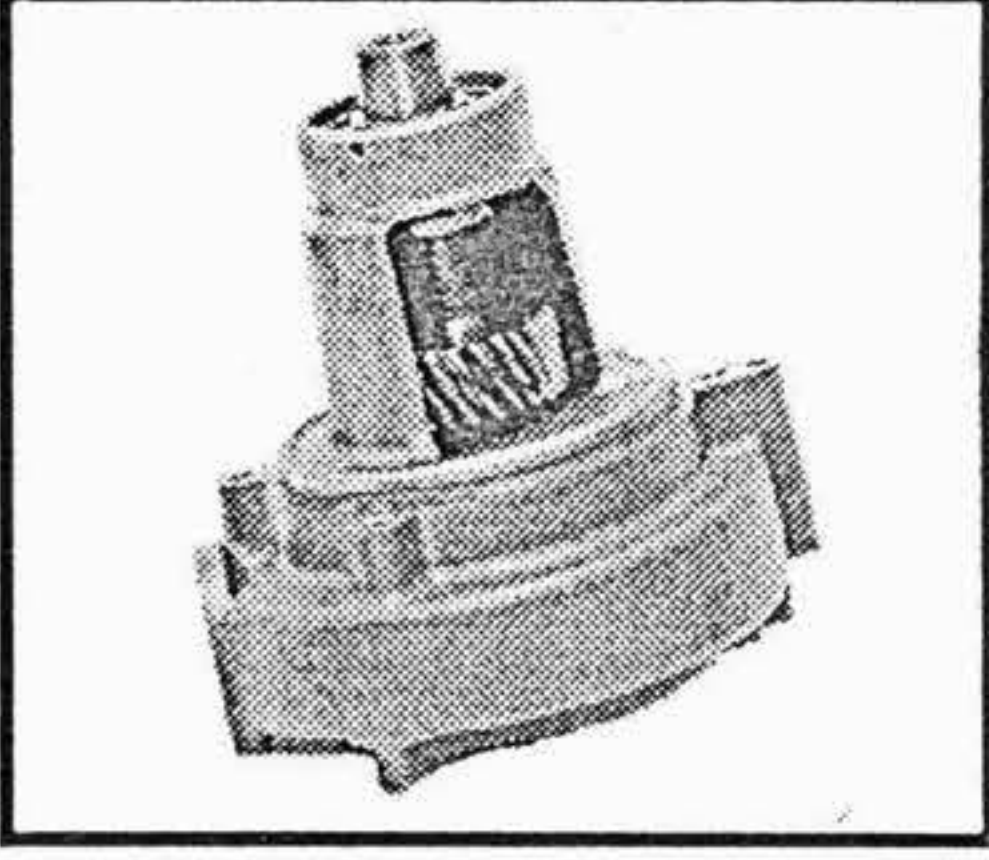
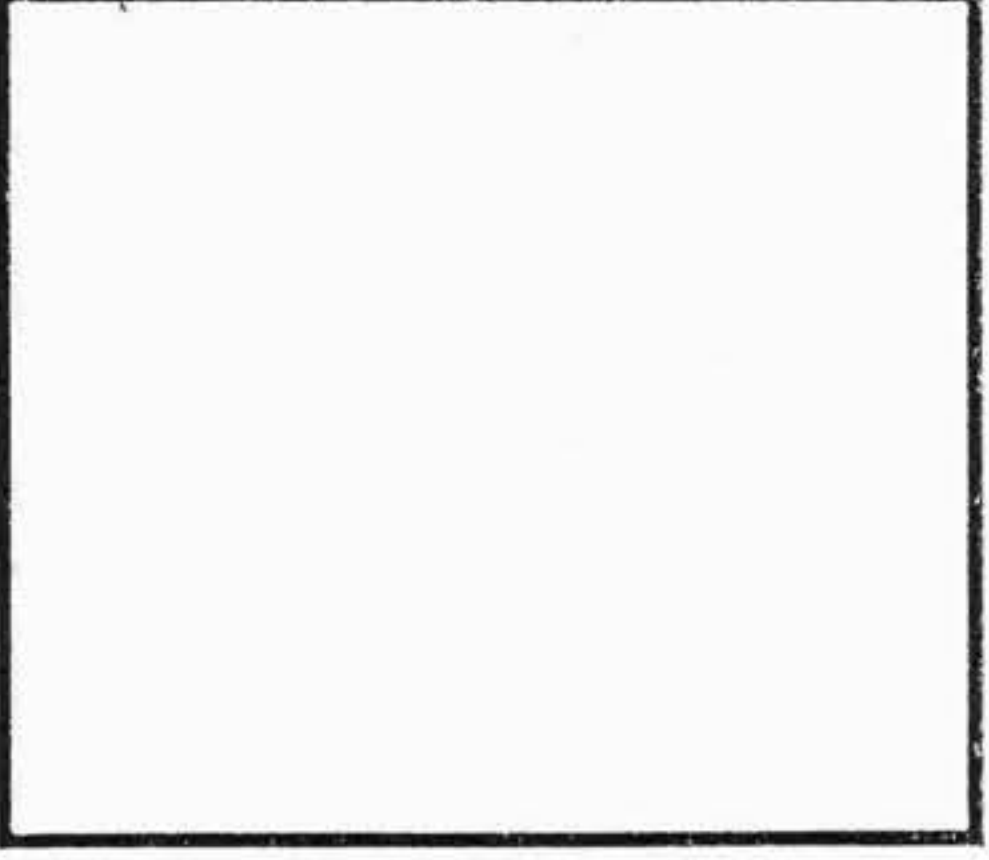
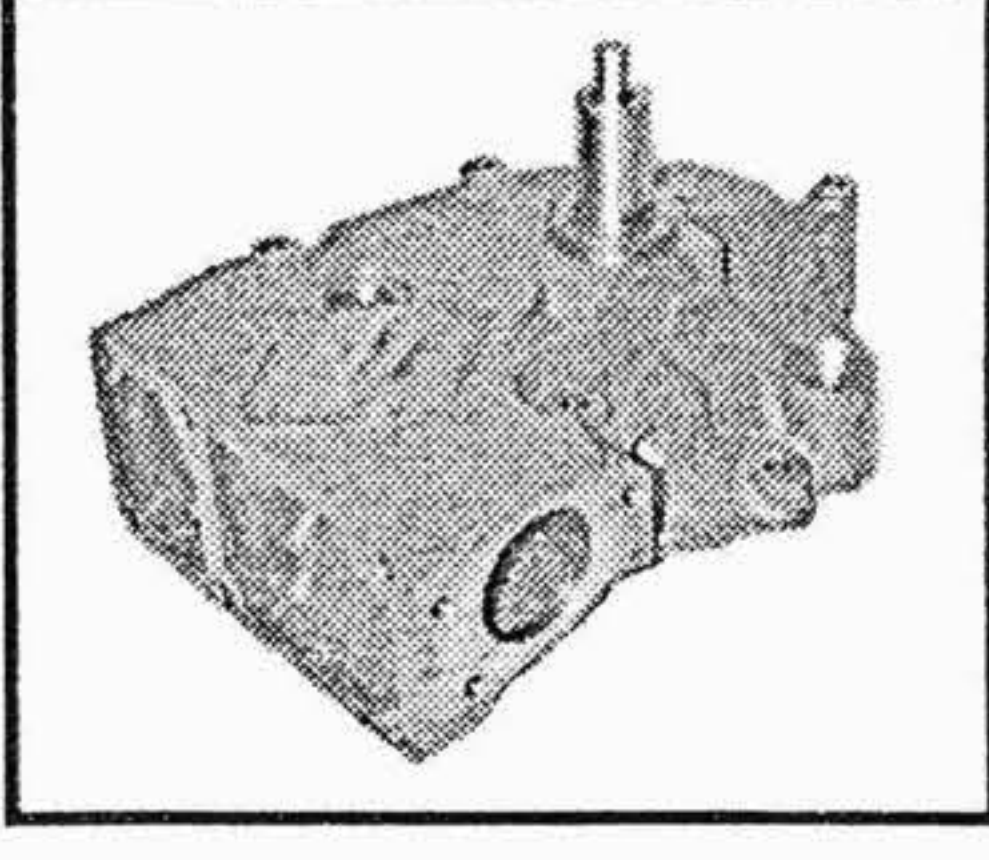
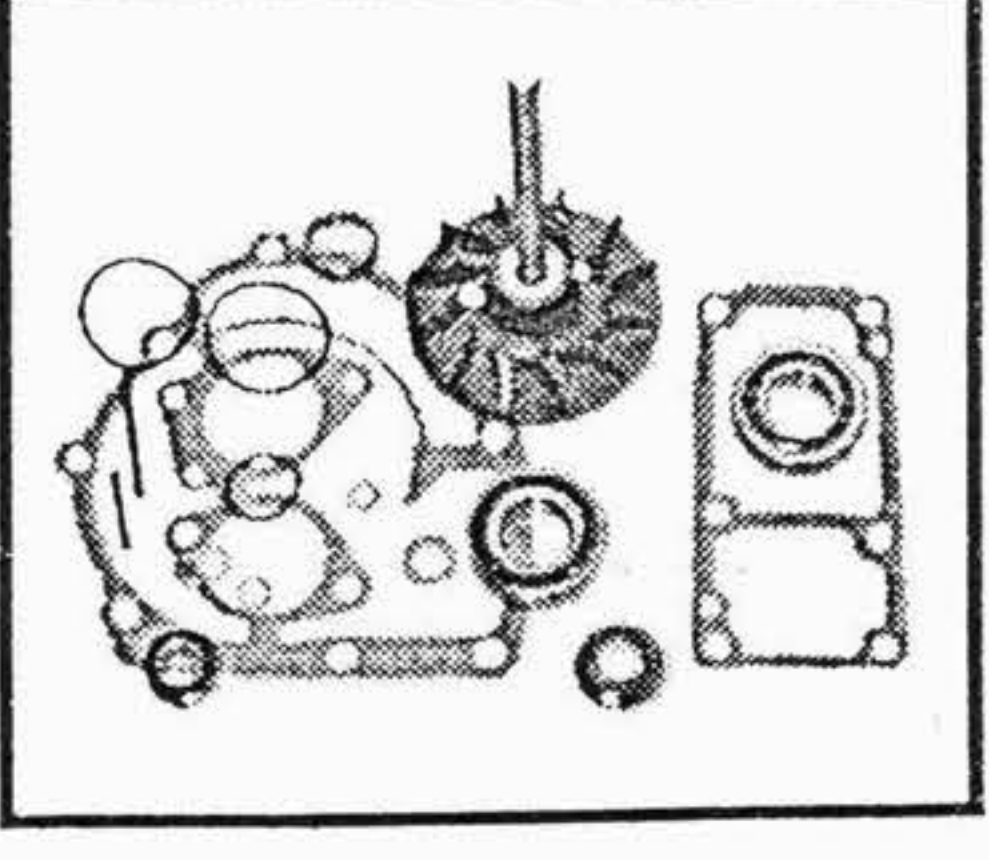

TIPO O MODELLO TYPE OU MODELE TYPE OR MODEL	MOTORE MOTEUR ENGINE	POMPA ACQUA POMPE A EAU WATER PUMP	KIT RIPARAZIONE NECESSAIRE DE REP. REPAIR KIT
<p>FH 12</p> <p>dal telaio / from chassis 2911152 ---></p> <p>FM 12</p> <p>Per versioni con cambio automatico</p> <p>Per versioni con ritardatore VOITH</p> <p>For vehicles with automatic gearbox</p> <p>For vehicles with VOITH hydraulic retarder</p>	<p>D 12 C</p> <p>D 12 C</p> <p>NEW !!</p>	<p>317.330 8170.833</p> 	<p>---</p> <p>---</p>  <p>NON DISPONIBILE NOT AVAILABLE</p>
<p>F 16</p>	<p>TD 162 F - FL</p> <p>TD 163 F - FL</p> <p>TD 164</p> <p>L330C Loading Shovel</p> <p>NEW !!</p>	<p>317.260 1556.330</p>  <p>SOST. DA : / REPLACE BY :</p> <p>317.270 8149.980</p>	<p>312.292 276.636</p> 
<p>FH 16</p> <p>NEW !!</p>	<p>D 16 A</p>	<p>317.270 8149.980</p> 	<p>312.293 276.637</p> 
<p>F 88</p> <p>N 88</p>	<p>D 100 B</p> <p>TD 100 A</p> <p>TD 100 B</p>	<p>317.050 422.311</p> 	<p>312.172 275.618</p> 

I ricambi non sono originali ma adattabili . Ogni riferimento originale é assolutamente indicativo .
Spare parts are not original but perfectly suitable . Every original part number has to be considered for reference purpose only .

SUITABLE

VOLVO

AUTOCARRI - CAMIONS - TRUCKS - LKW
Tel:+44(0)1925 850082 Fax: +(0)44 1925 850083
www.spwaterpumps.co.uk

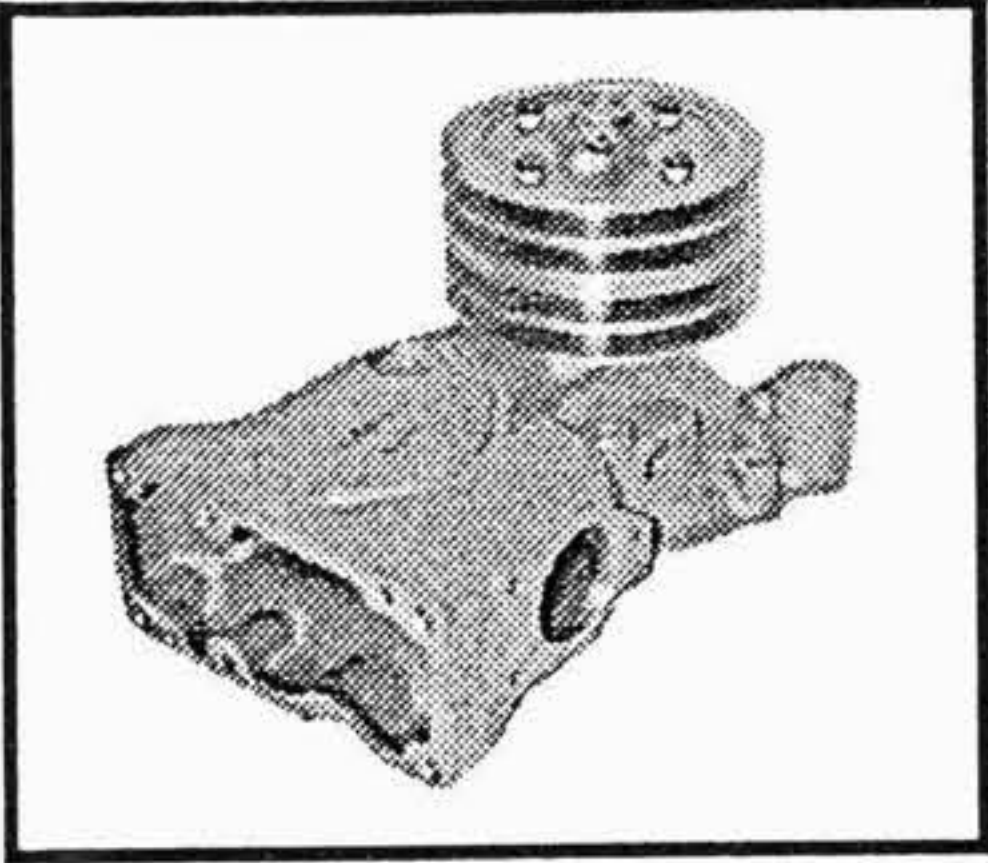
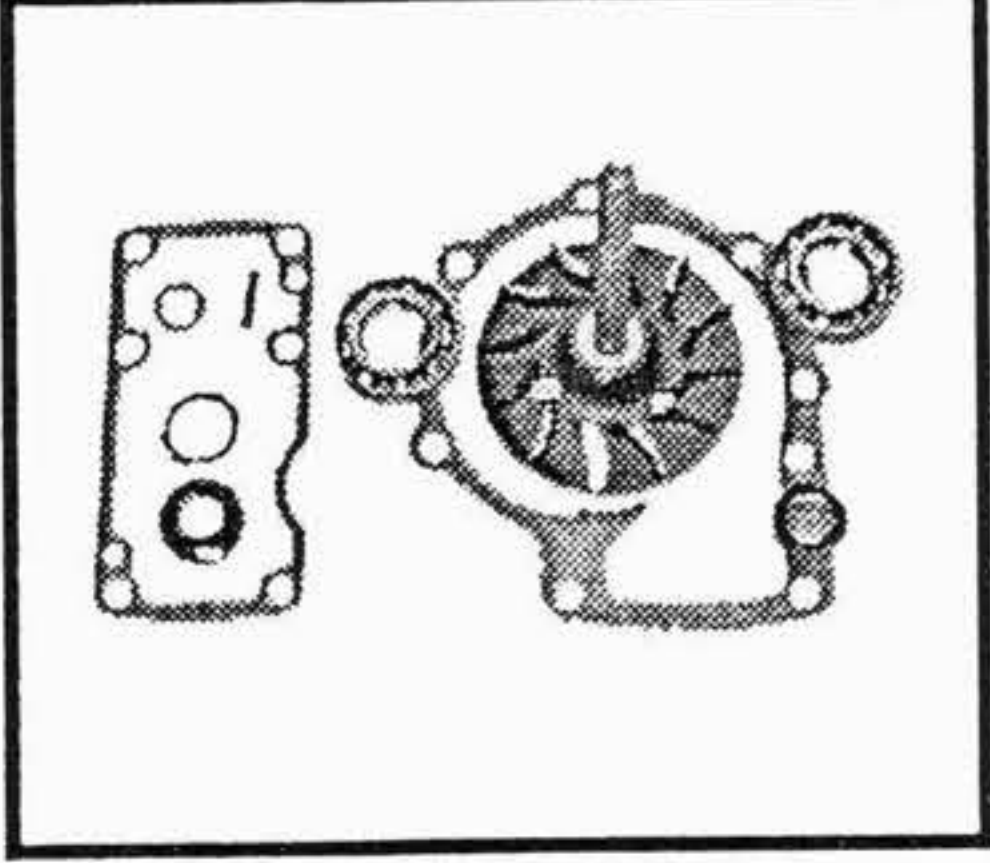
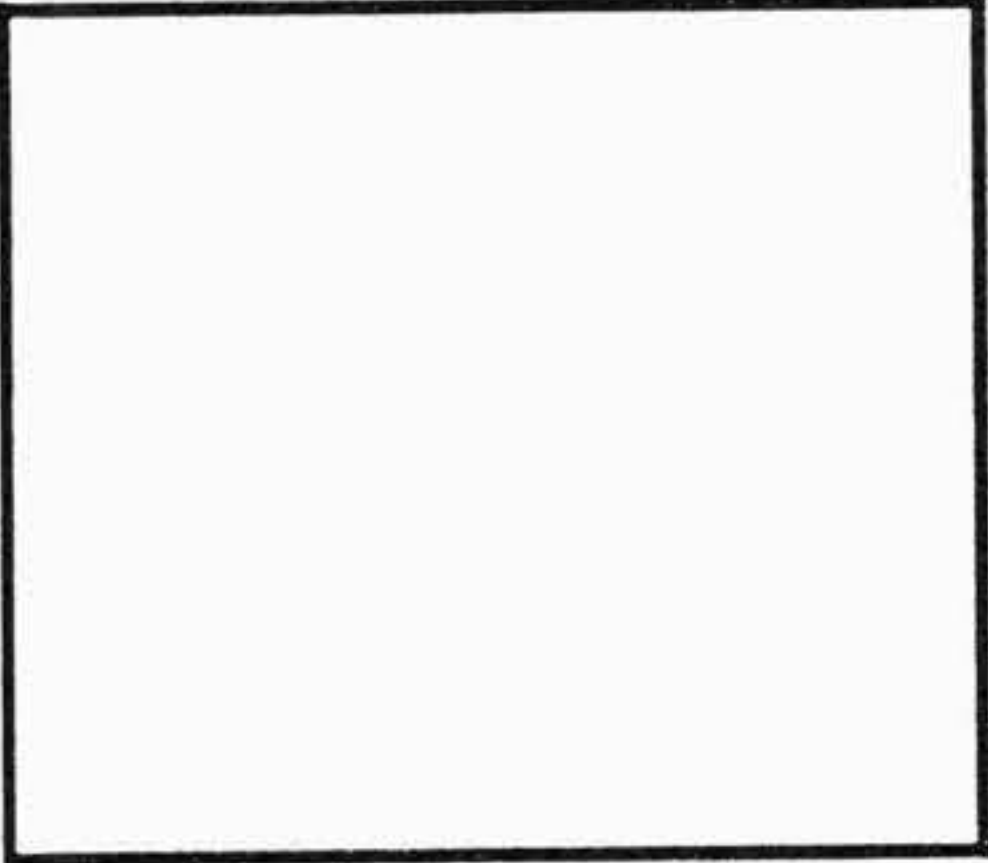
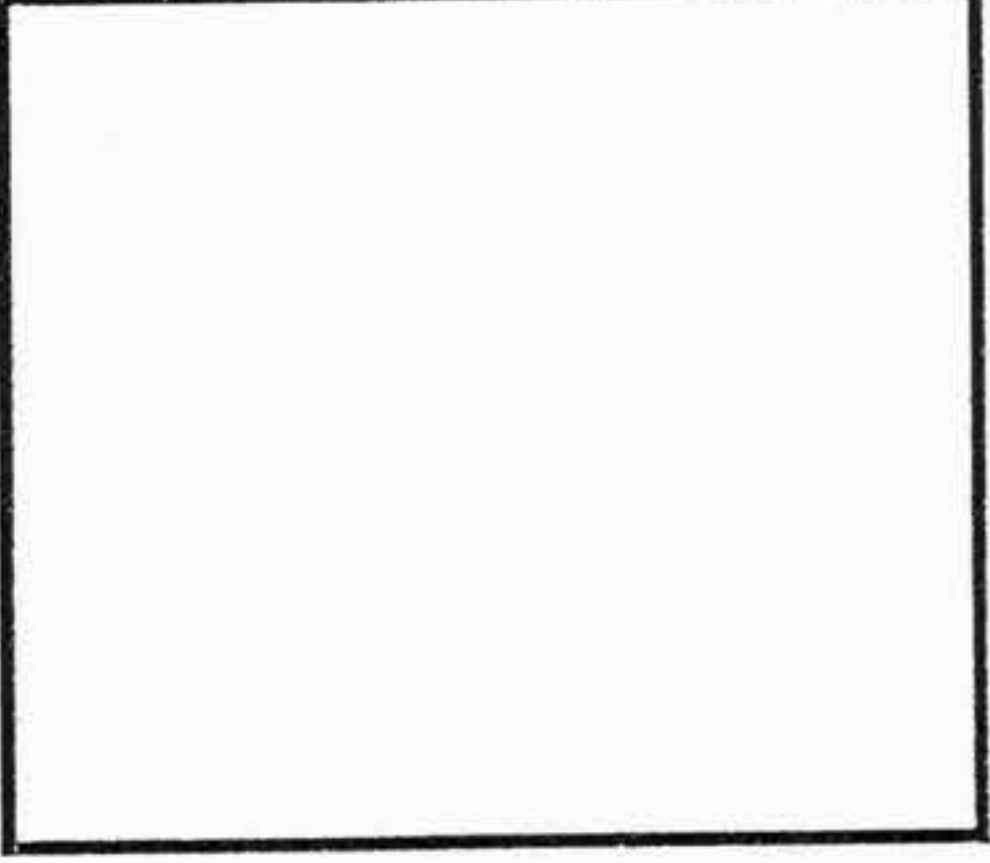
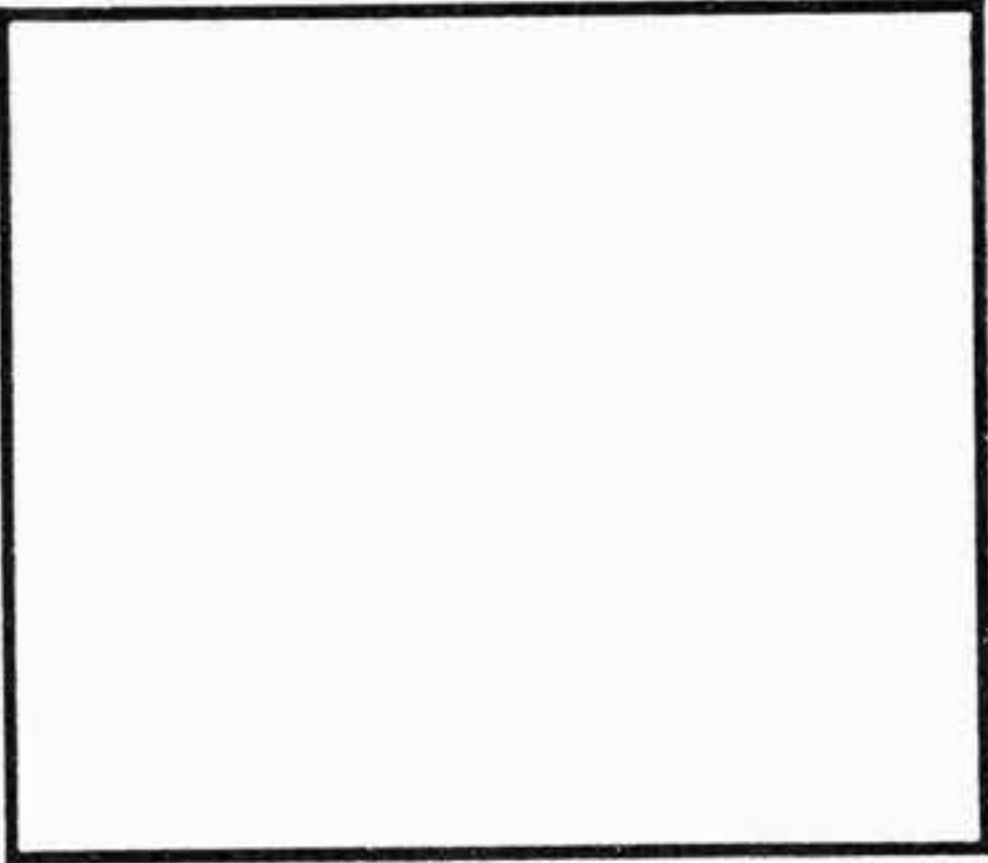
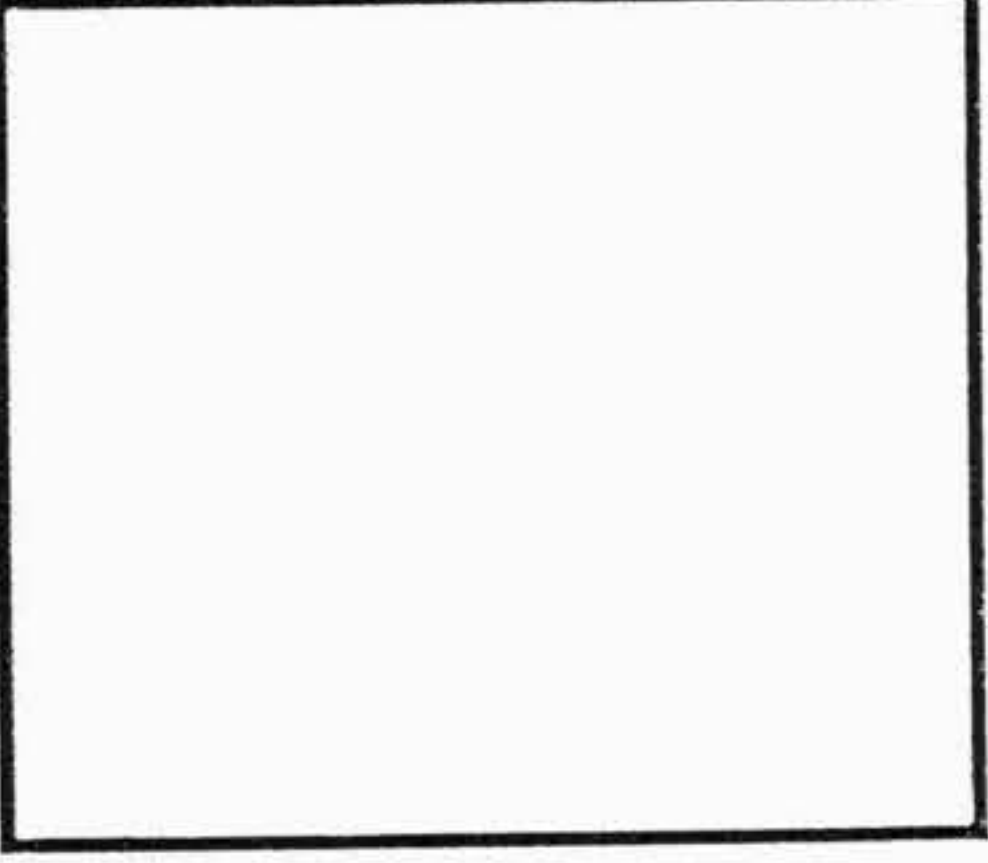
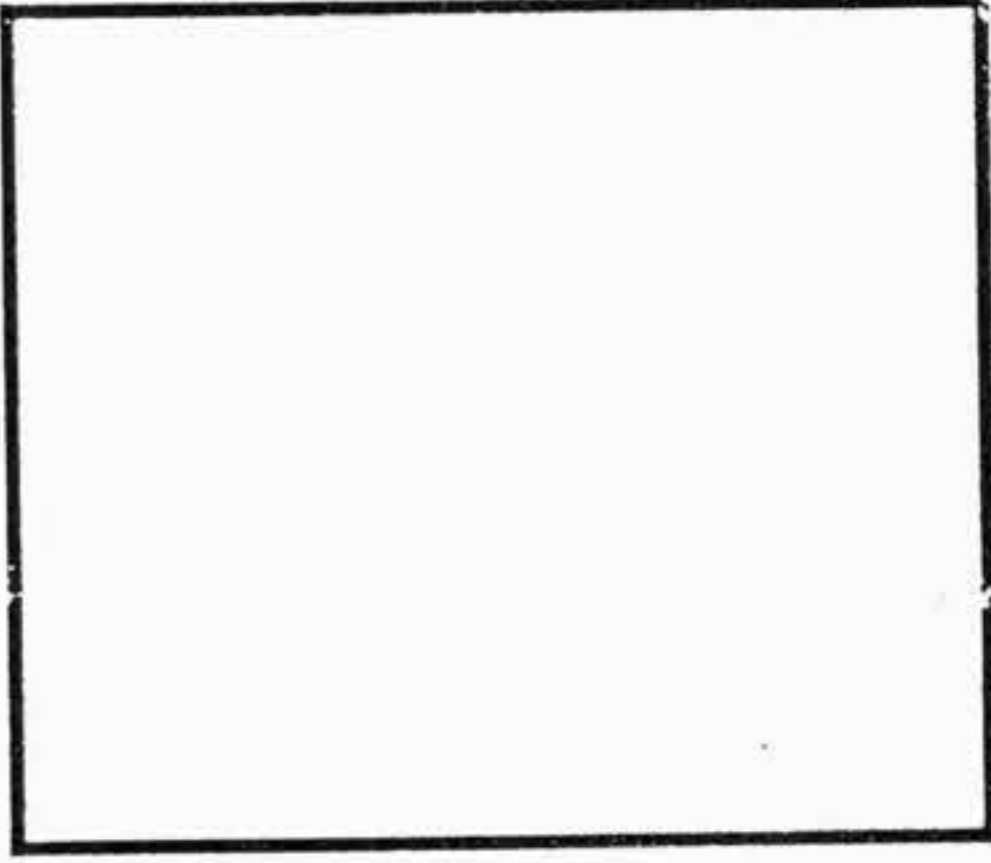
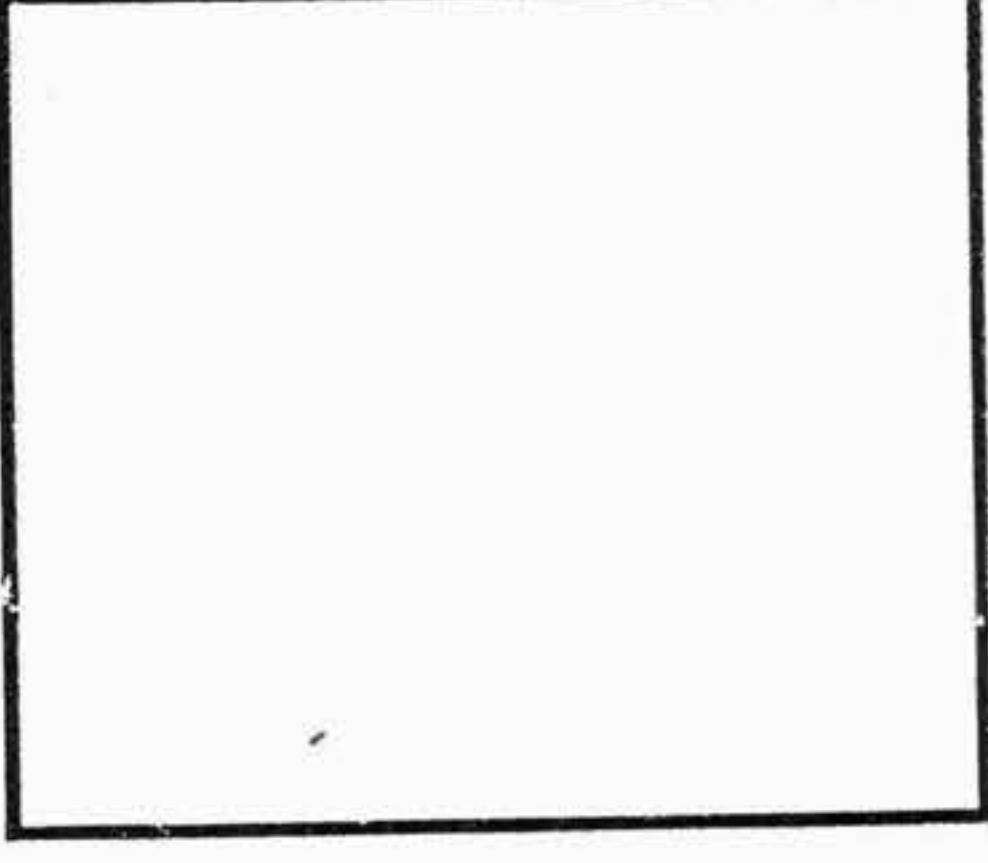

TIPO O MODELLO TYPE OU MODELE TYPE OR MODEL	MOTORE MOTEUR ENGINE	POMPA ACQUA POMPE A EAU WATER PUMP	KIT RIPARAZIONE NECESSAIRE DE REP. REPAIR KIT
F 89 N 89	TD 120 TD 100 A	<p>317.090 423.333</p> 	<p>312.169 275.613</p> 
			
			
			

I ricambi non sono originali ma adattabili . Ogni riferimento originale é assolutamente indicativo .
 Spare parts are not original but perfectly suitable . Every original part number has to be considered for reference purpose only .

SUITABLE

VOLVO

AUTOBUS - AUTOCARS - BUSES - OMNIBUSSE

Tel:+44(0)1925 850082 Fax: +(0)44 1925 850083

www.spwaterpumps.co.uk

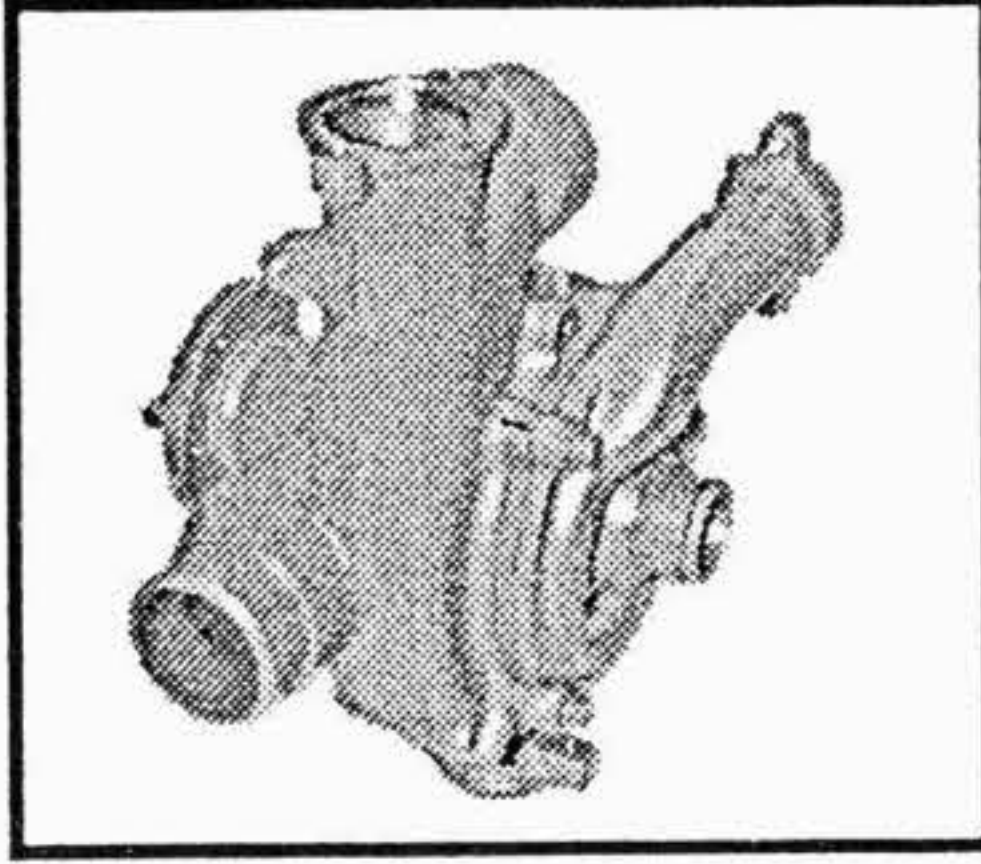
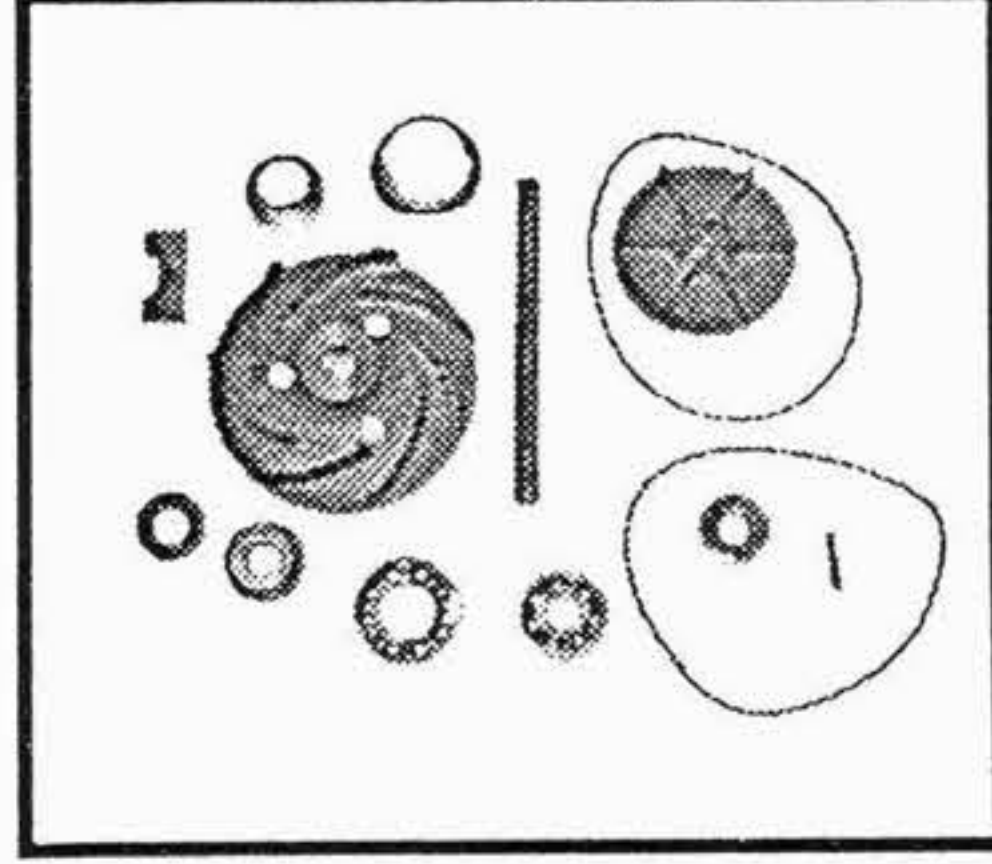
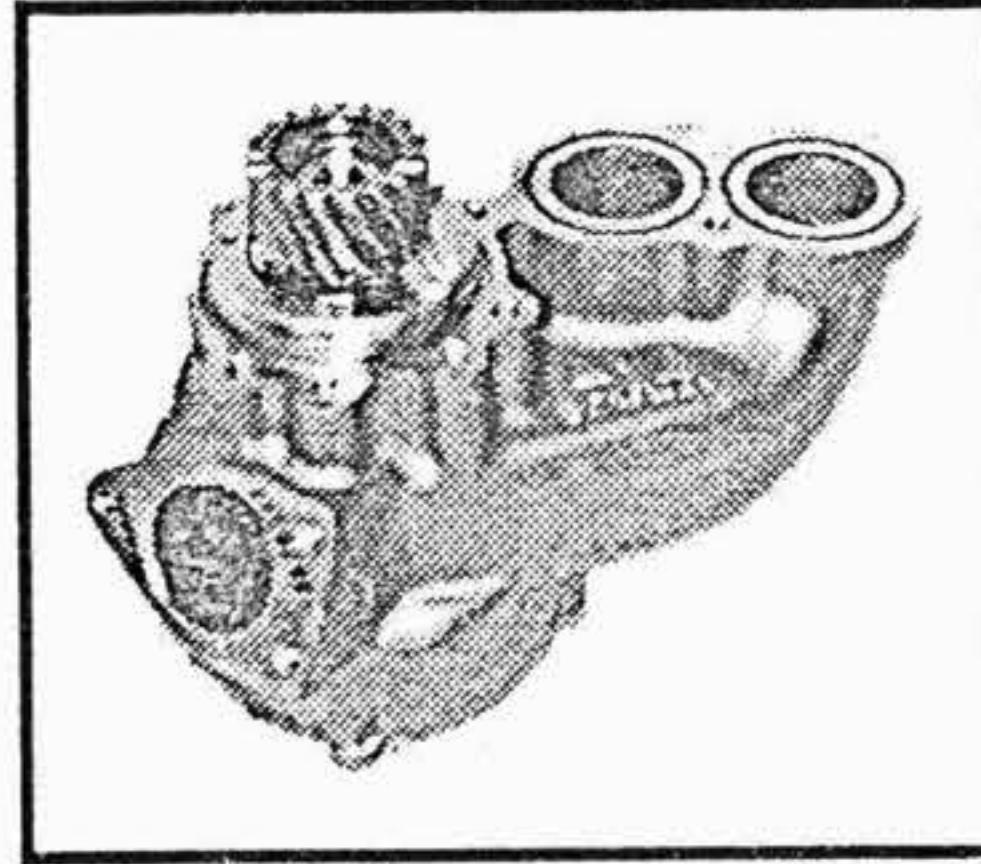
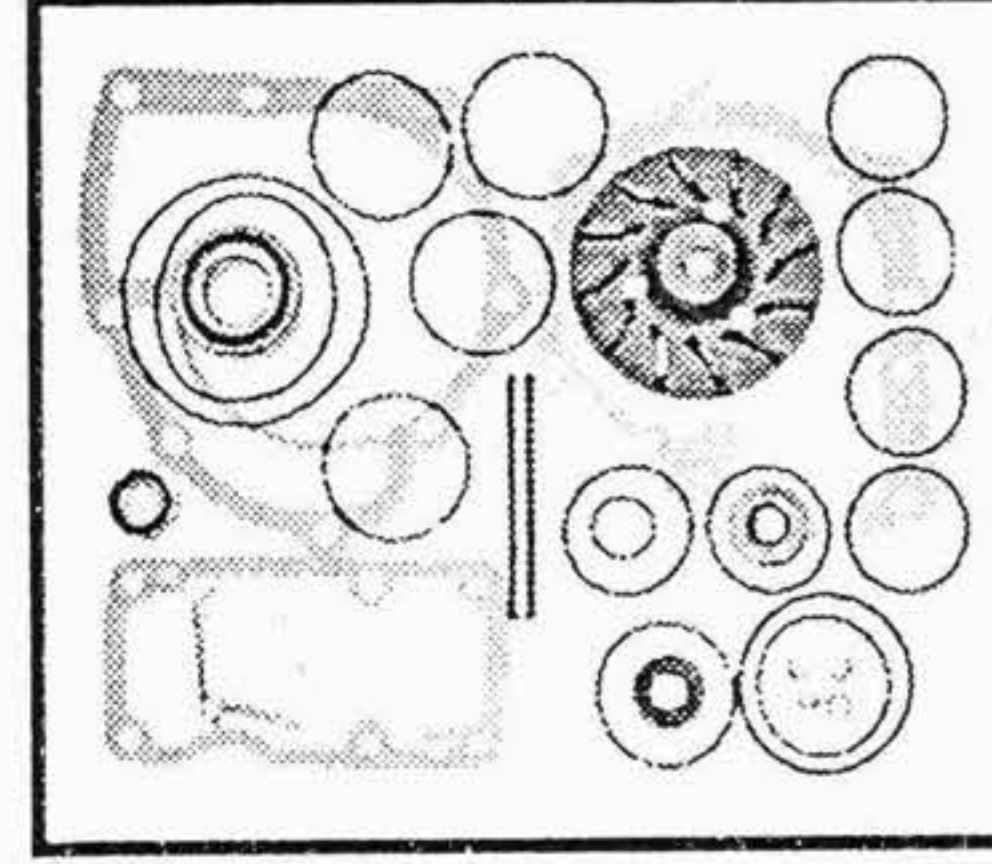
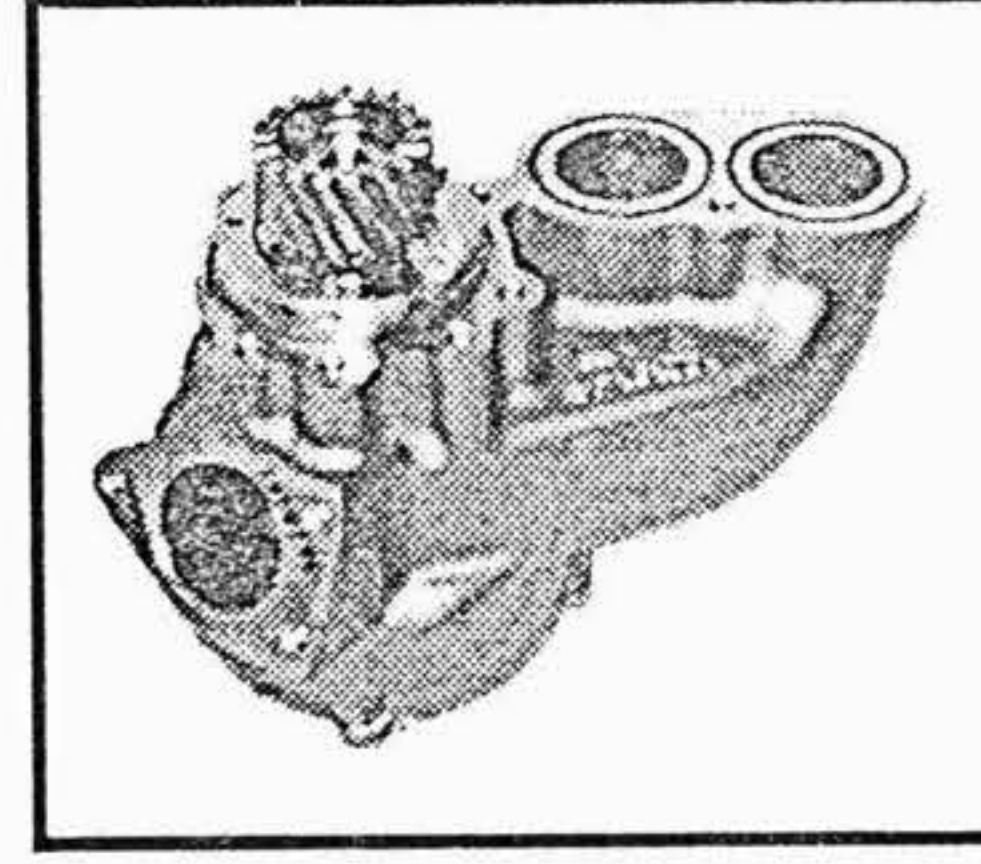
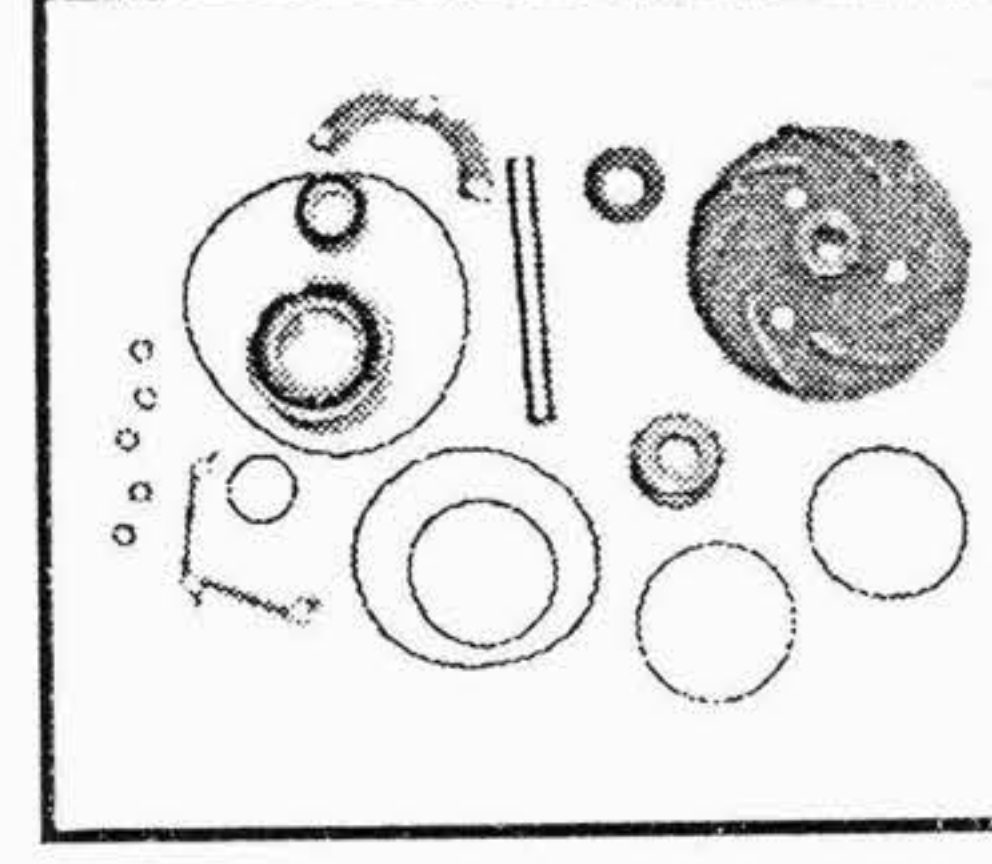
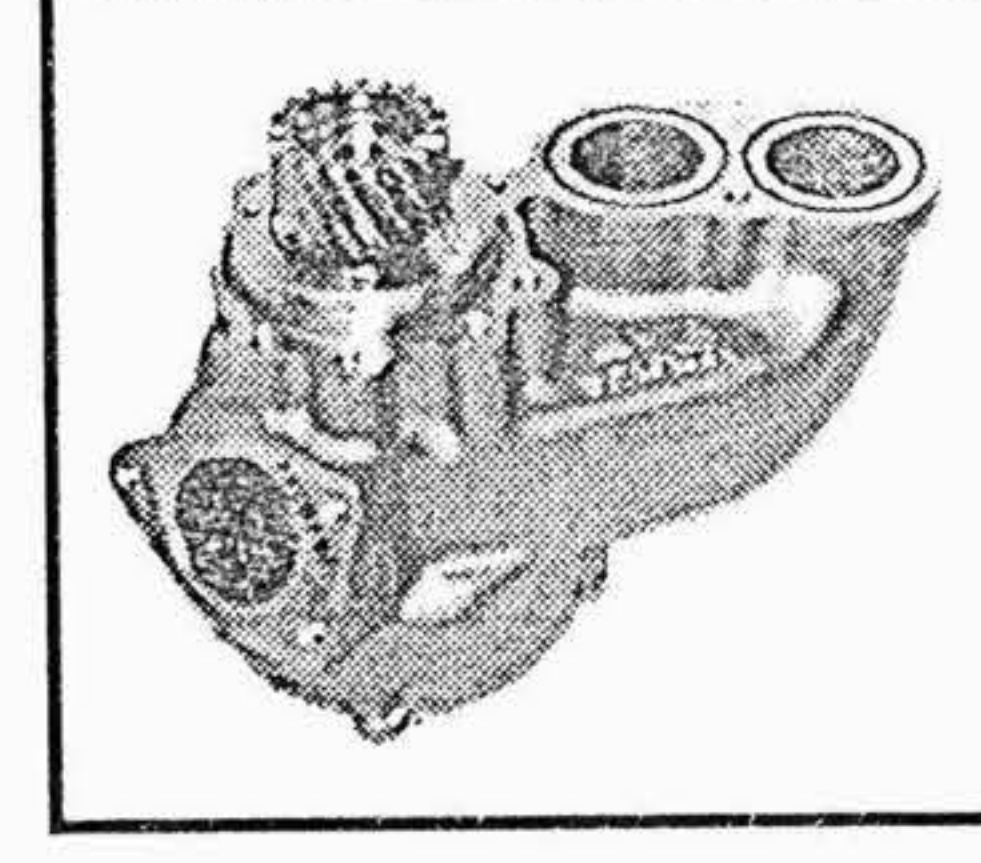
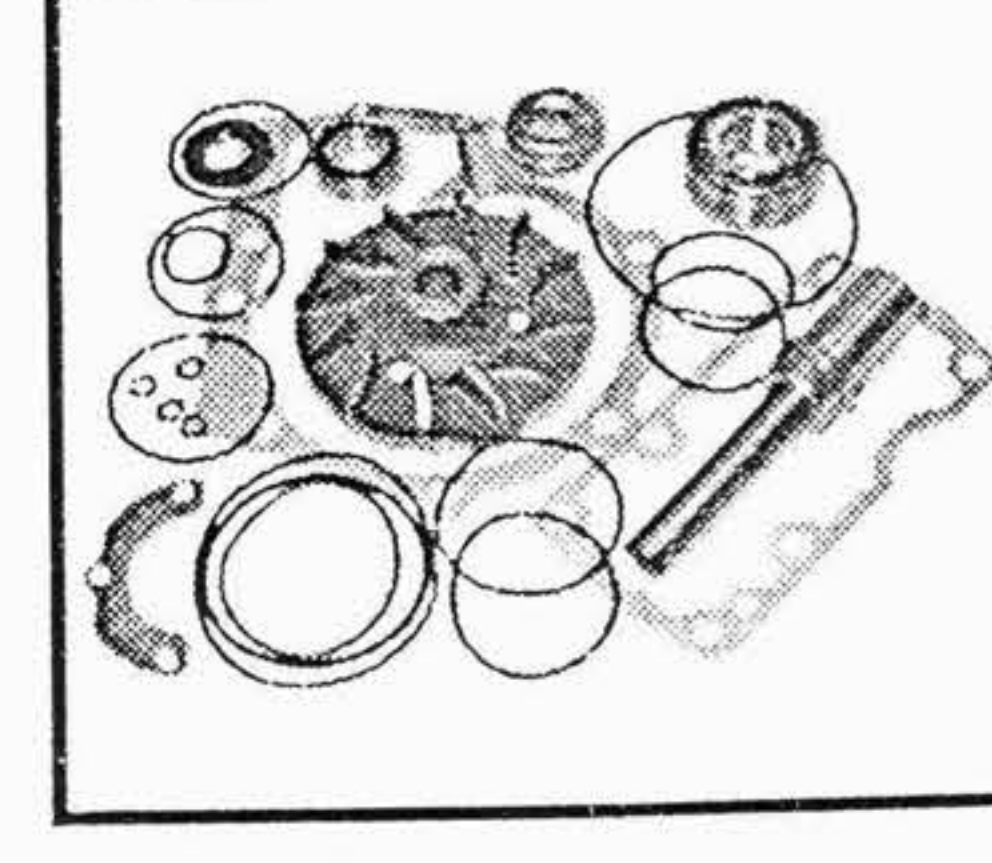

TIPO O MODELLO TYPE OU MODELE TYPE OR MODEL	MOTORE MOTEUR ENGINE	POMPA ACQUA POMPE A EAU WATER PUMP	KIT RIPARAZIONE NECESSAIRE DE REP. REPAIR KIT
B 10 B - SFL 12 B 10 B Excellence 1000 / L / Shuttle B 10 B - SL 12 B 10 M MK III B 10 R B 10 L C 10 M <div style="text-align: right; font-size: 2em; font-weight: bold; transform: rotate(-15deg);">NEW !!</div>	THD 102 KB THD 102 KD THD 102 KK THD 103 KB THD 103 KD THD 103 KF	317.290 425.268 	312.294 3097.084 
B 12 Olympian Mk II	TD 120 TD 121 TD 122 FK TD 122 FS TD 122 FL TD 122 FH	317.160 1545.261 	312.276 276.802  in alternativa / alternatively use 312.171 275.615
B 12 Olympian Mk II	TD 122 FK - OCS TD 122 FS - OCS TD 122 FL - OCS TD 122 FH - OCS	317.190 422.791 	312.175 270.791 
B 12 ---> fino al telaio N° 4999 Olympian Mk II <div style="text-align: right; font-size: 2em; font-weight: bold; transform: rotate(-15deg);">NEW !!</div>	TD 123 E TD 123	317.240 1675.945 	312.278 276.814 

I ricambi non sono originali ma adattabili . Ogni riferimento originale é assolutamente indicativo .
 Spare parts are not original but perfectly suitable . Every original part number has to be considered for reference purpose only .

SUITABLE



VOLVO

AUTOBUS - AUTOCARS - BUSES - OMNIBUSSE

Tel:+44(0)1925 850082 Fax: +(0)44 1925 850083

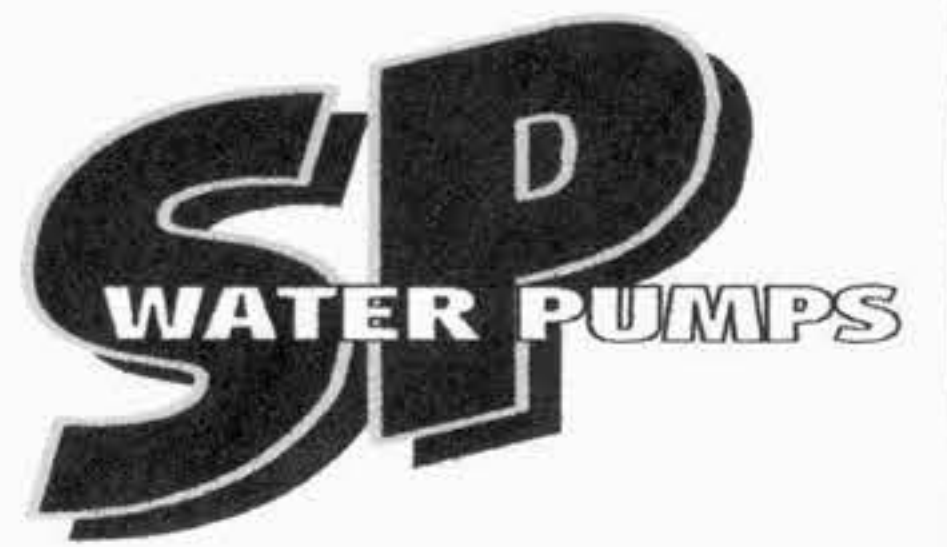
www.spwaterpumps.co.uk

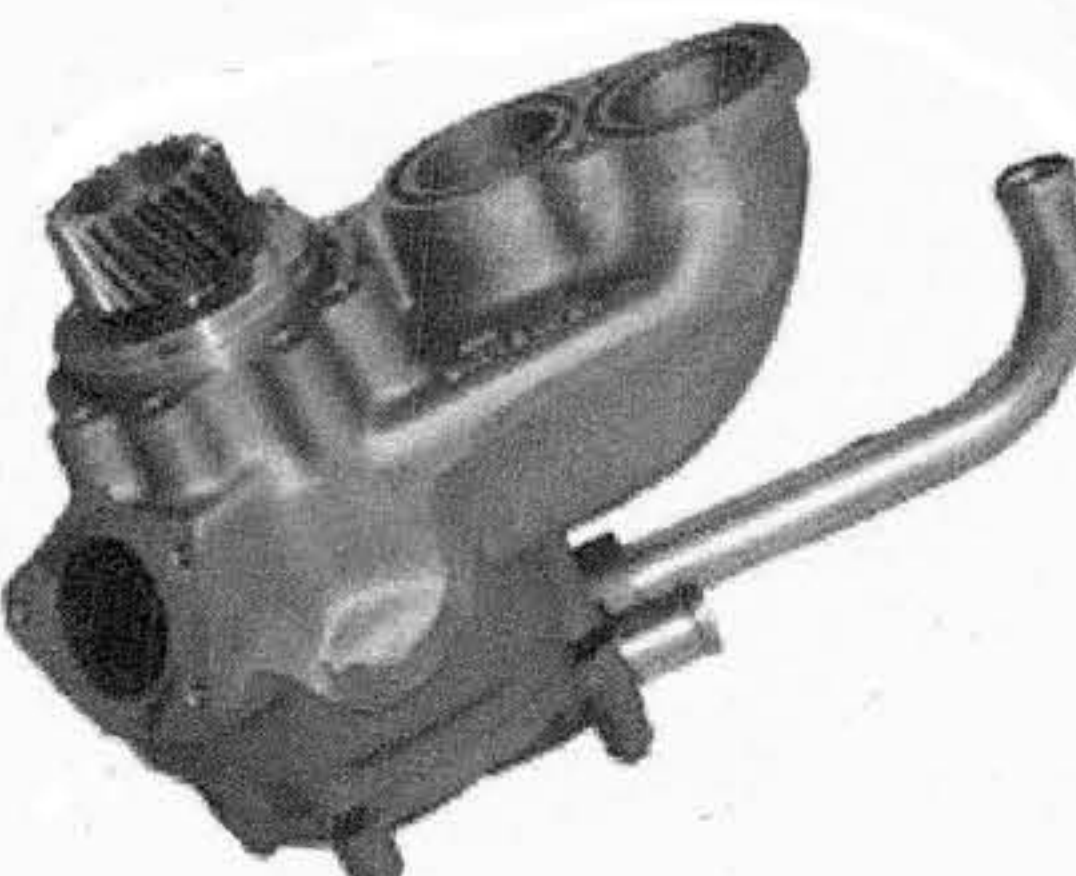
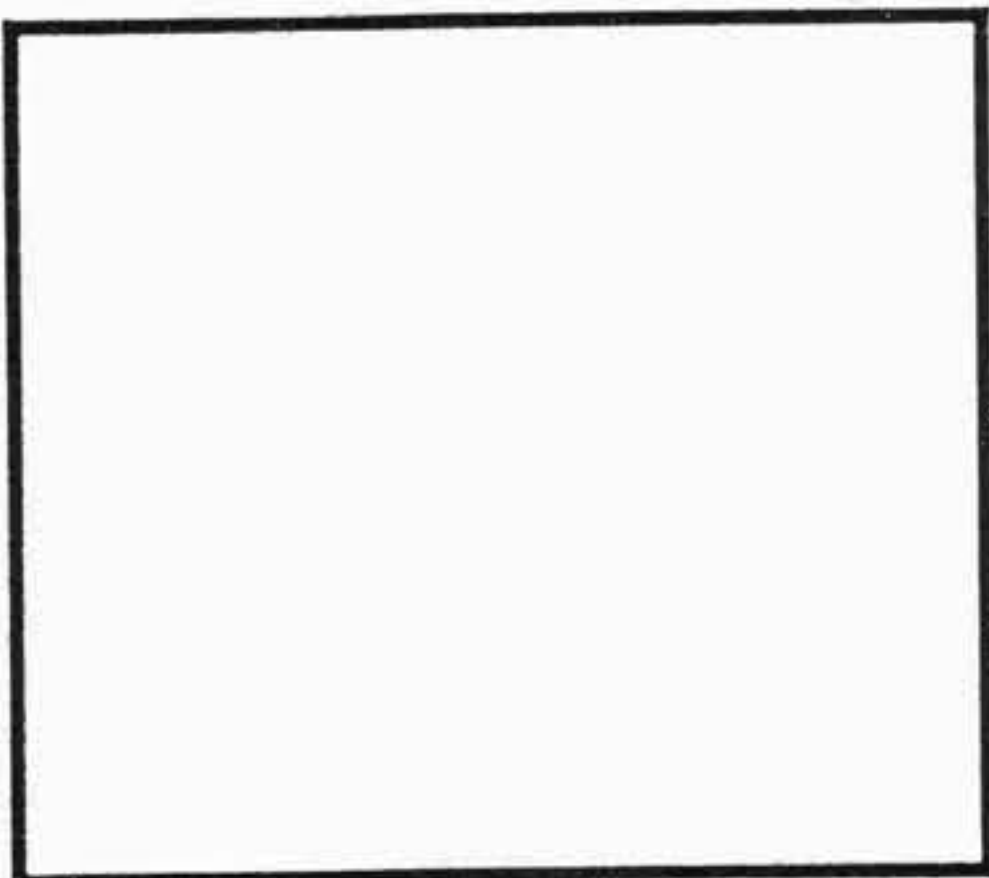
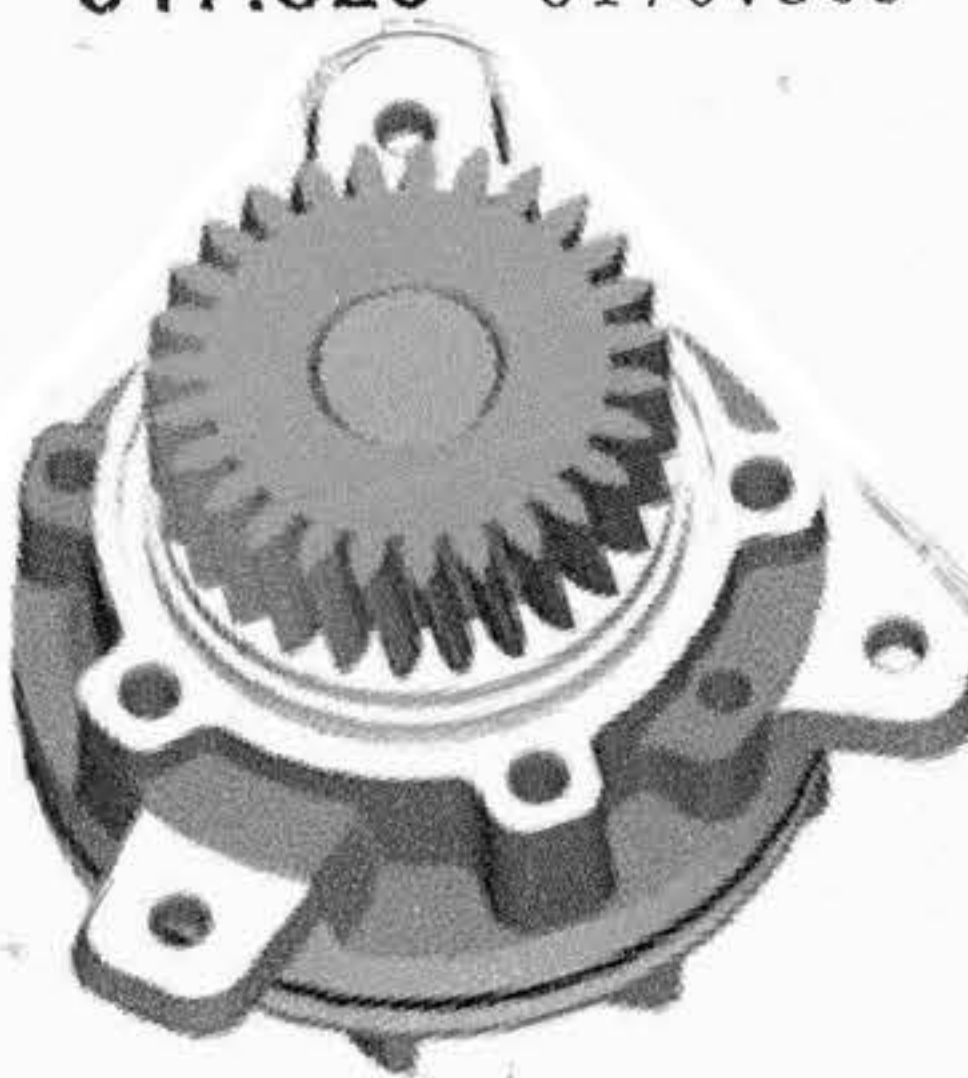
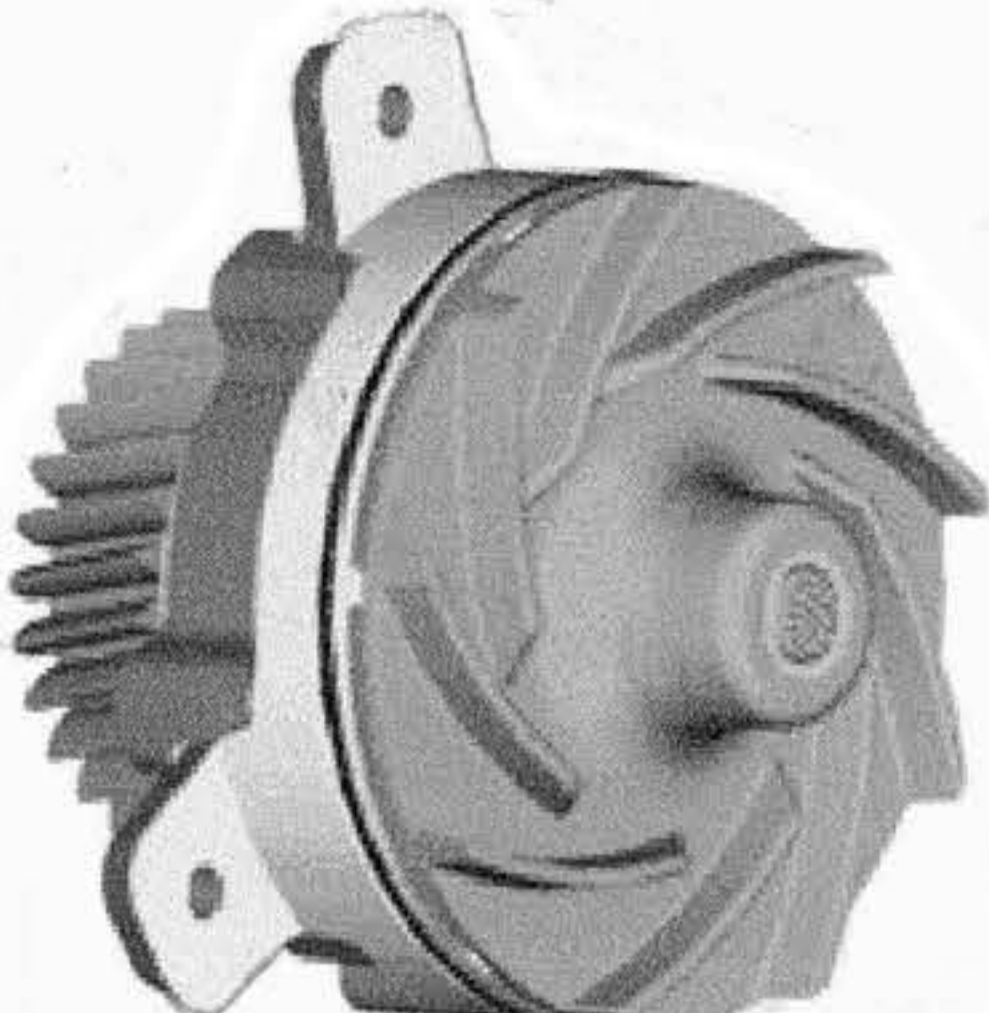
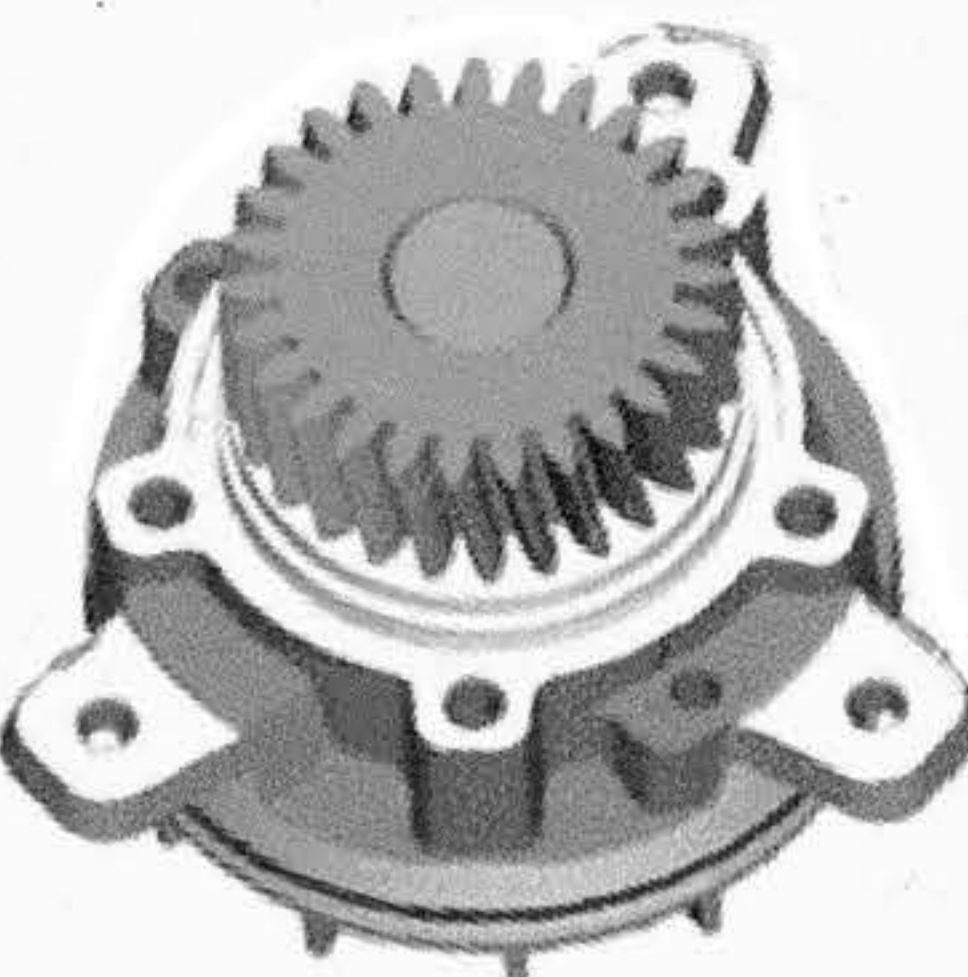
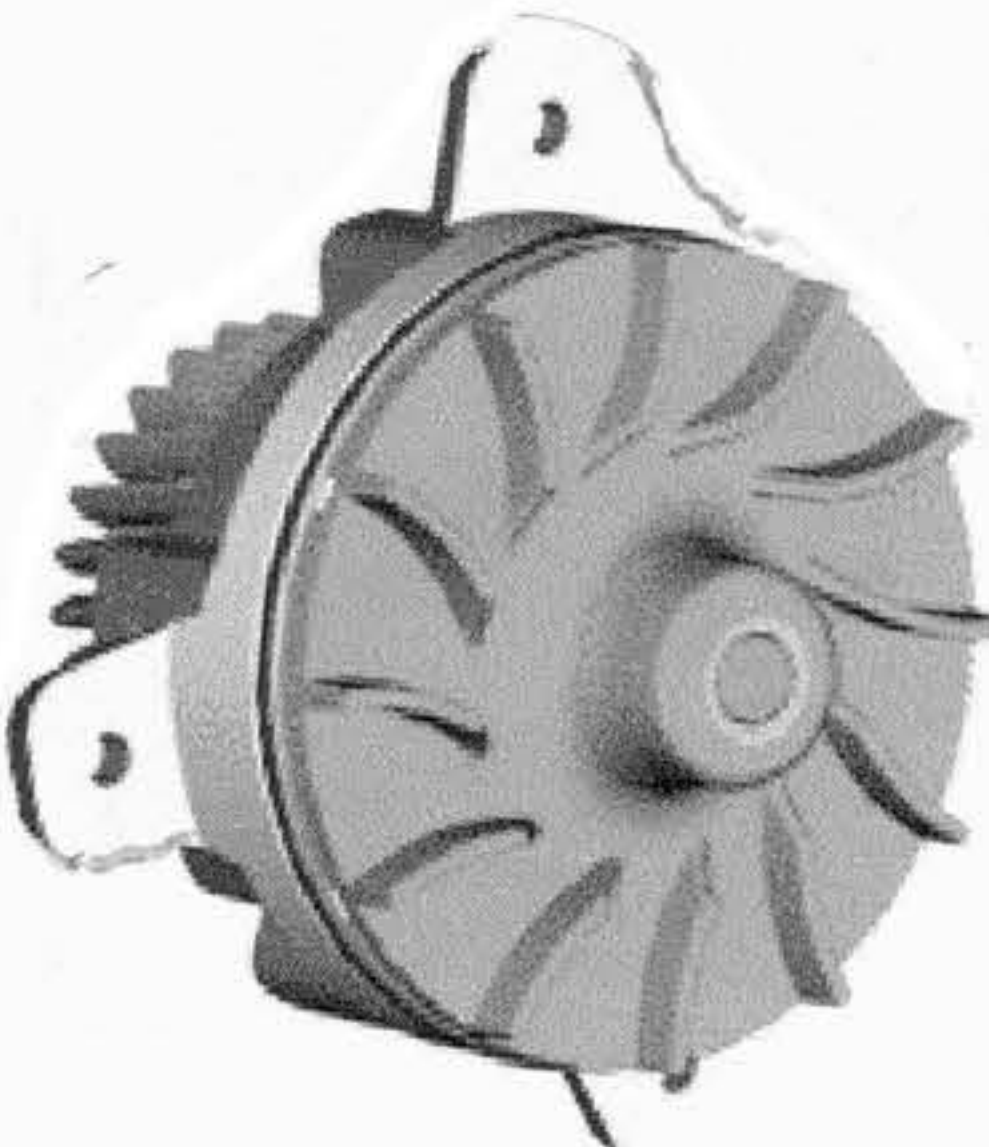

TIPO O MODELLO TYPE OU MODELE TYPE OR MODEL	MOTORE MOTEUR ENGINE	POMPA ACQUA POMPE A EAU WATER PUMP	OMP REF. / O.E.M. REF	KIT RIPARAZIONE NECESSAIRE DE REP. REPAIR KIT	OMP REF. / O.E.M. REF
B 12 OLYMPIAN Mk II	TD 102 KF D10A	<p>317.300 425.751</p>  <p>85000412</p>	<p>312.295 3097.368 3097402</p> 		
<p>FH 12</p> <p>dal telaio / from chassis 2911152 ---> AFTER CHASSIS No 29911152</p> <p>FM 12</p> <p>Per versioni con cambio manuale <i>For vehicles with manual gearbox</i> *</p>	<p>8113274 85000452 2073427</p> <p>D 12 C</p>	<p>317.320 8170.305</p> 			
<p>FH 12</p> <p>dal telaio / from chassis 2911152 ---></p> <p>FM 12</p> <p>Per versioni con cambio automatico <i>Per versioni con ritardatore VOITH</i></p> <p><i>For vehicles with automatic gearbox</i> * <i>For vehicles with VOITH hydraulic retarder</i></p>	<p>D 12 C 8112375</p> <p>D 12 C</p>	<p>317.330 8170.833</p> 			
<p>F 16</p>	<p>TD 162 F - FL TD 163 F - FL</p>	<p>317.260 1556.330</p> <div data-bbox="924 2524 1381 2916" style="border: 1px solid black; padding: 5px;"> <p>Questo complessivo pompa acqua è stato sostituito con il tipo L' Ensemble de pompe d' eau a ete remplacè par le modele This complex of water pump has been replaced by the type O.E. 8149.980 - OMP 317.270 Questa pagina resta valida per i ricambi Cette page reste valable pour les pièces de recharge . This page remain valid for the spare parts</p> </div>	<p>312.292 276.636</p> 		

NEW !!

NEW !!

NEW !!

NEW !!

VOLVO

Tel: +(0)44 1925 850082 Fax: +(0)44 1925 850083
www.spwaterpumps.co.uk



TYPE OR MODEL	ENGINE	WATER PUMP	WATER PUMP
VOLVO B10M MK 111 8112356	UK Version ZSP1933	317.275 	317.275 
FM7 B6, B7, B7L, B7R HIGH OUTPUT 85000387	TD 73 ZSP1930 Latest High Output FM7, B7I	317.350 	317.298 
VOLVO FM9 D9A 85000214 85000062 85000486 20744939 3161436	D9A ZSP1945 AUTOBUS - 8300, 9300	ZSP1945 AWAITING PHOTO	
VOLVO B12M, B12B 85000412 85000476 85000657 85000337 1549491 8170833 8170305 20592629 20568564	B12B, B12M ZSP1943 B12, DH12D DH12C AUTOBUS- 9700	ZSP1942 AWAITING PHOTO	

VOLVO

Tel: +(0)44 1925 850082 Fax: +(0)44 1925 850083
www.spwaterpumps.co.uk



TYPE OR MODEL	ENGINE	WATER PUMP	REPAIR KIT



SECTION 3412

APPLICATION

VOLVO BM

**WATER PUMPS WASSERPUMPEN
POMPE A EAU BOMBA DE AGUA
POMPA ACQUA**

**S.P. WATER PUMPS LTD
18 Tatton Court, Kingsland Grange, Woolston,
Warrington, Cheshire. ENGLAND. WAI 4RR
TEL: +44(0) 1925 850082 Fax: +44(0) 1925 850083
Email:sales@spwaterpumps.co.uk Web Site:www.spwaterpumps.co.uk**

SUITABLE

VOLVO BM TRACTORS

Tel: +44(0)1925 850082 Fax: +(0)44 1925 850083

www.spwaterpumps.co.uk

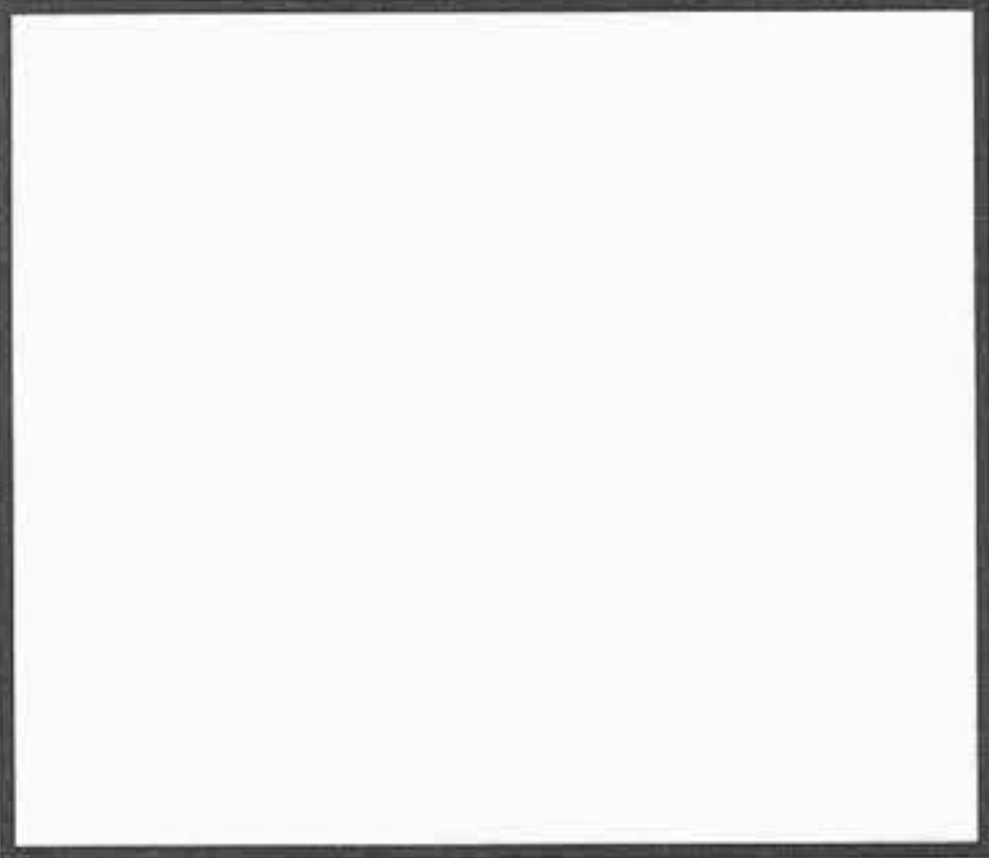
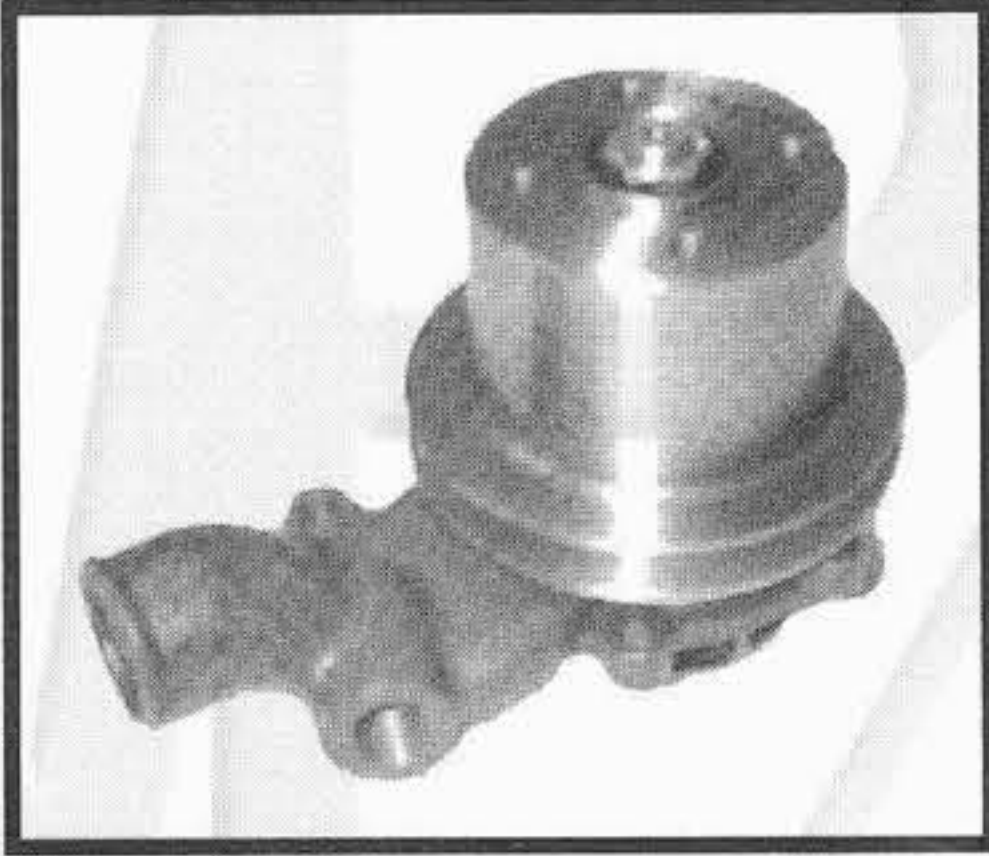
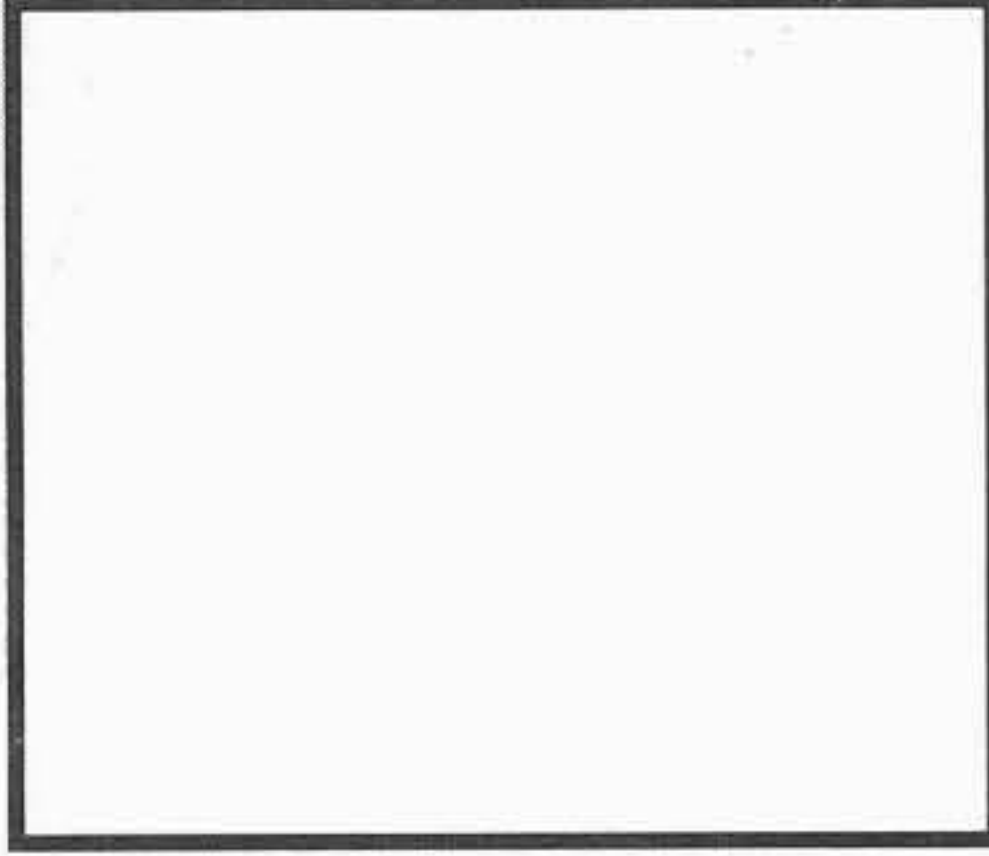
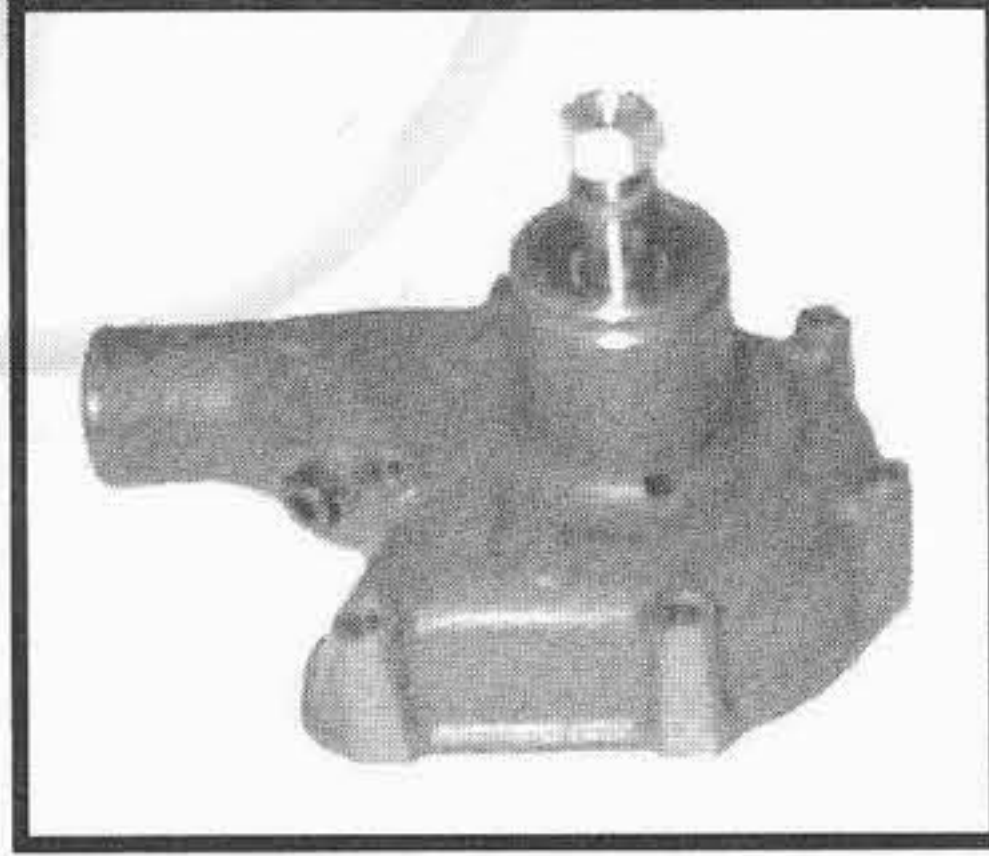
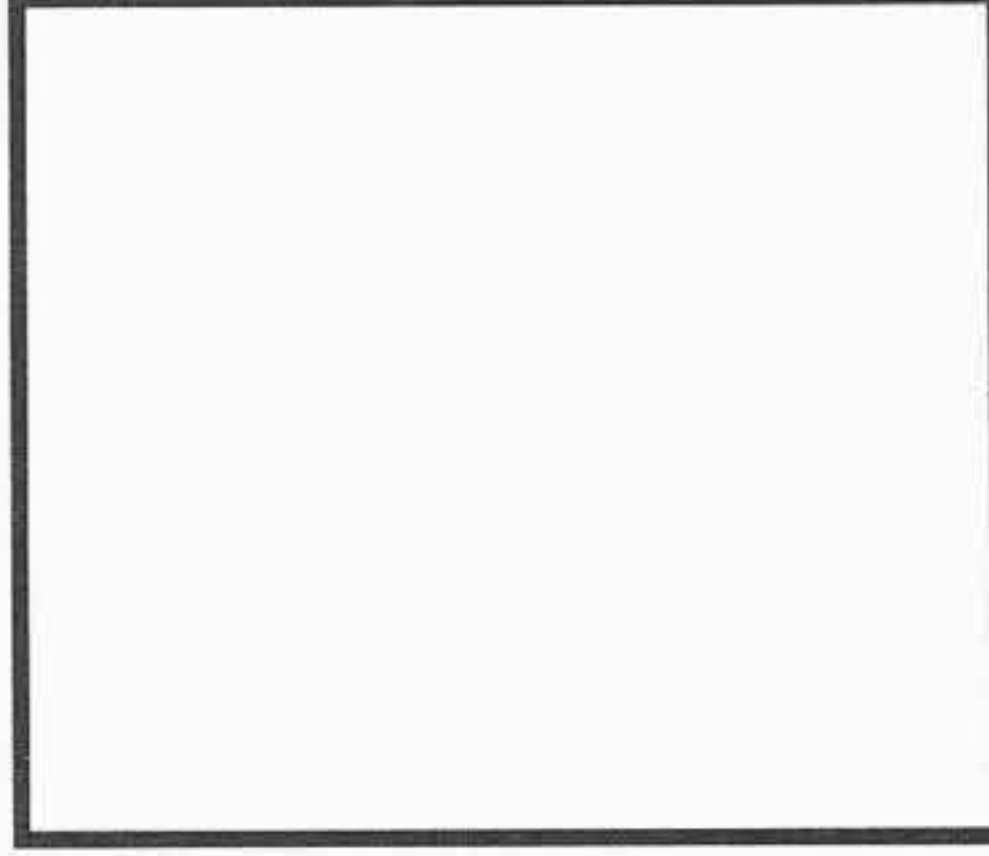
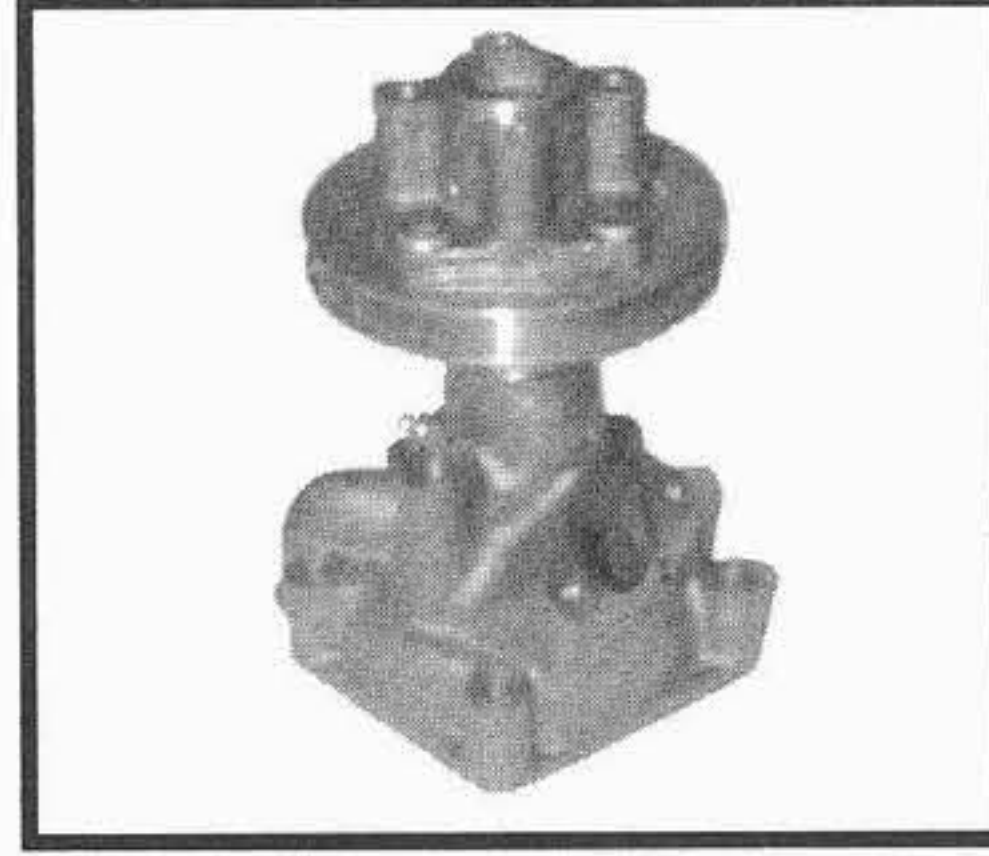
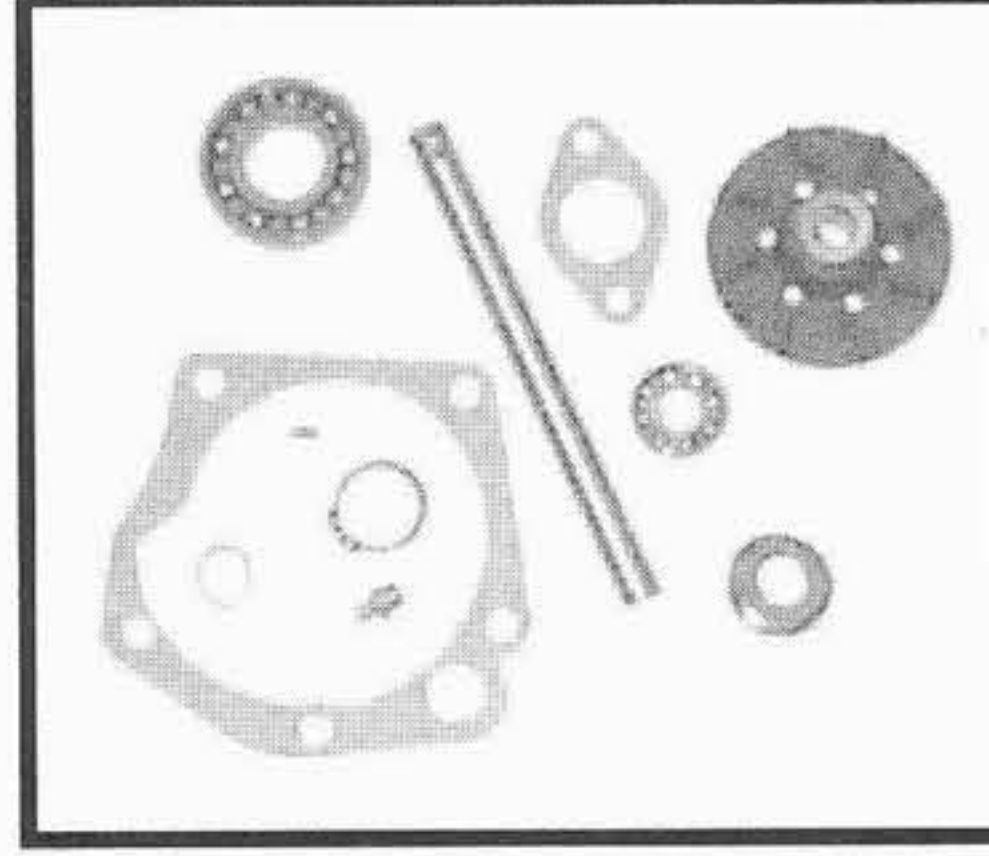

TIPO O MODELLO TYPE OU MODELE TYPE OR MODEL	MOTORE MOTEUR ENGINE	POMPA ACQUA POMPE A EAU WATER PUMP	KIT RIPARAZIONE NECESSAIRE DE REP. REPAIR KIT
		OMP REF. / O.E.M. REF	OMP REF. / O.E.M. REF
BM 320 BM 400 BM 430	A3.152 AD3.152	319.375 6613.038 	312.130 754.108 
BM 500 2200 - 2204 2250 - 2254	4.236	319.450 484.120A CON PULEGGIA / WITH PULLEY  319.490 484.120 SENZA PULEGGIA / WITHOUT PULLEY	312.176 275.614 
BM 950	6.354	159.090 41313045 	152.097 U7LW0009 
BM 350 BOXER BM 600 BOXER		317.140 772.781 	312.289 

I ricambi non sono originali ma adattabili . Ogni riferimento originale é assolutamente indicativo .
 Spare parts are not original but perfectly suitable . Every original part number has to be considered for reference purpose only .

SUITABLE

VOLVO BM TRACTORS

Tel: +44(0)1925 850082 Fax: +44(0)1925 850083

www.spwaterpumps.co.uk

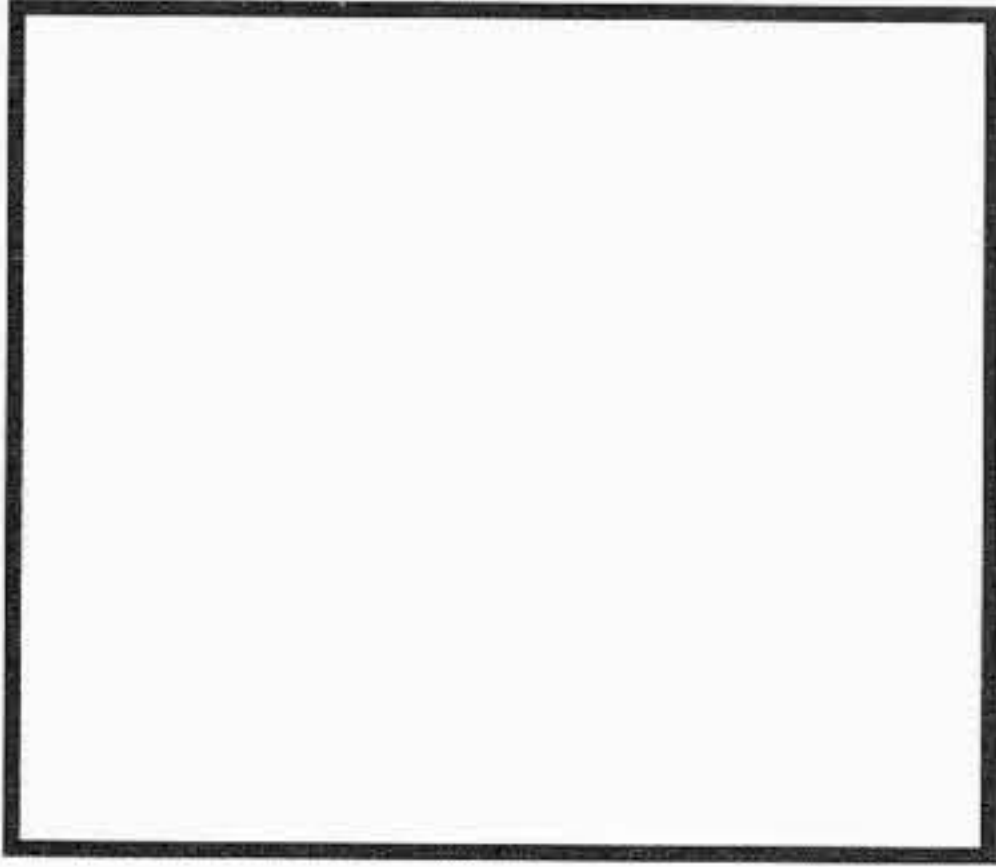
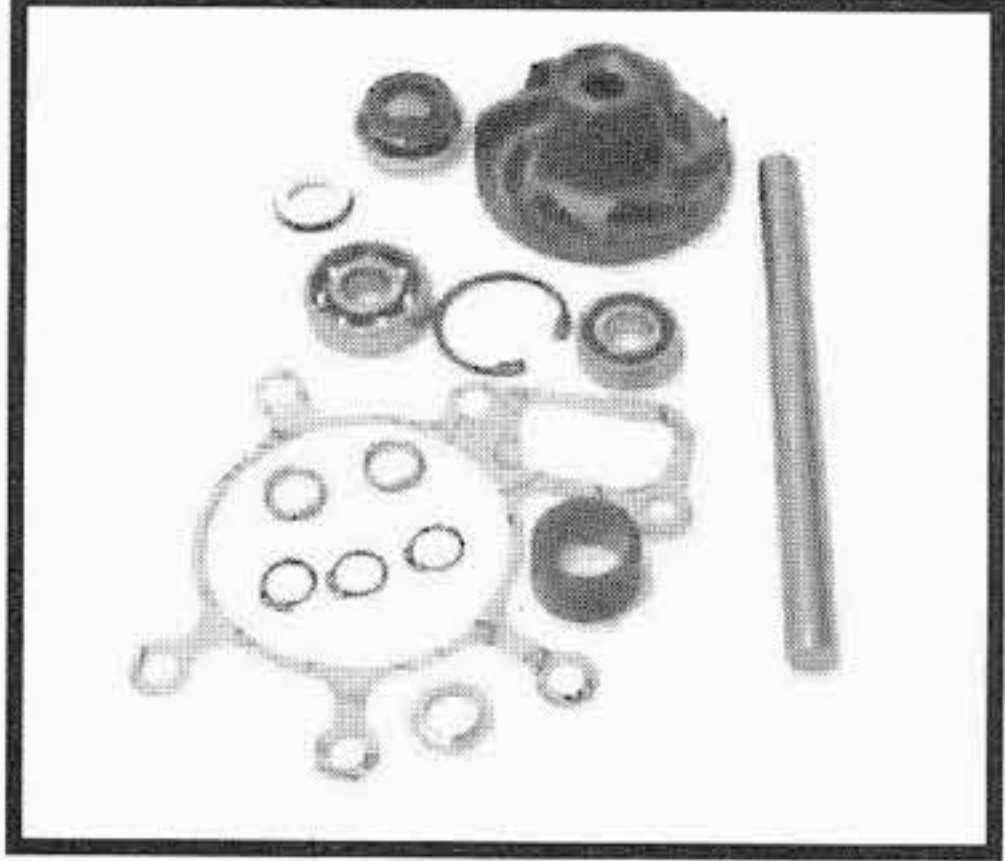
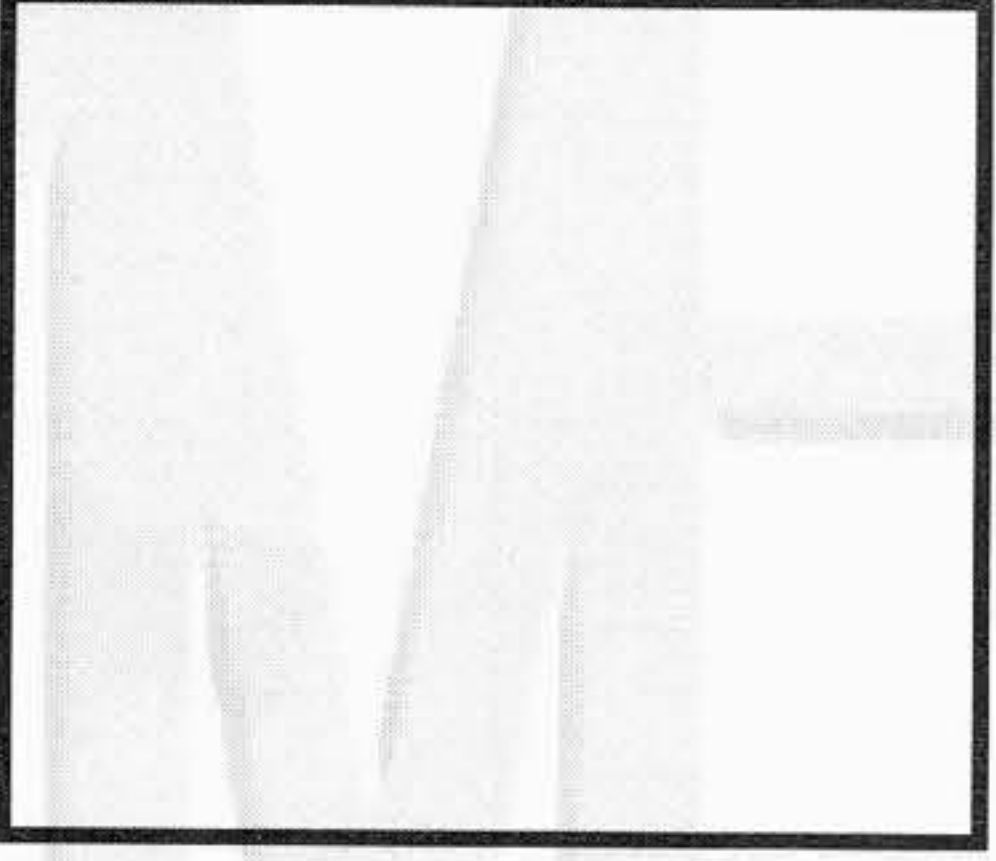
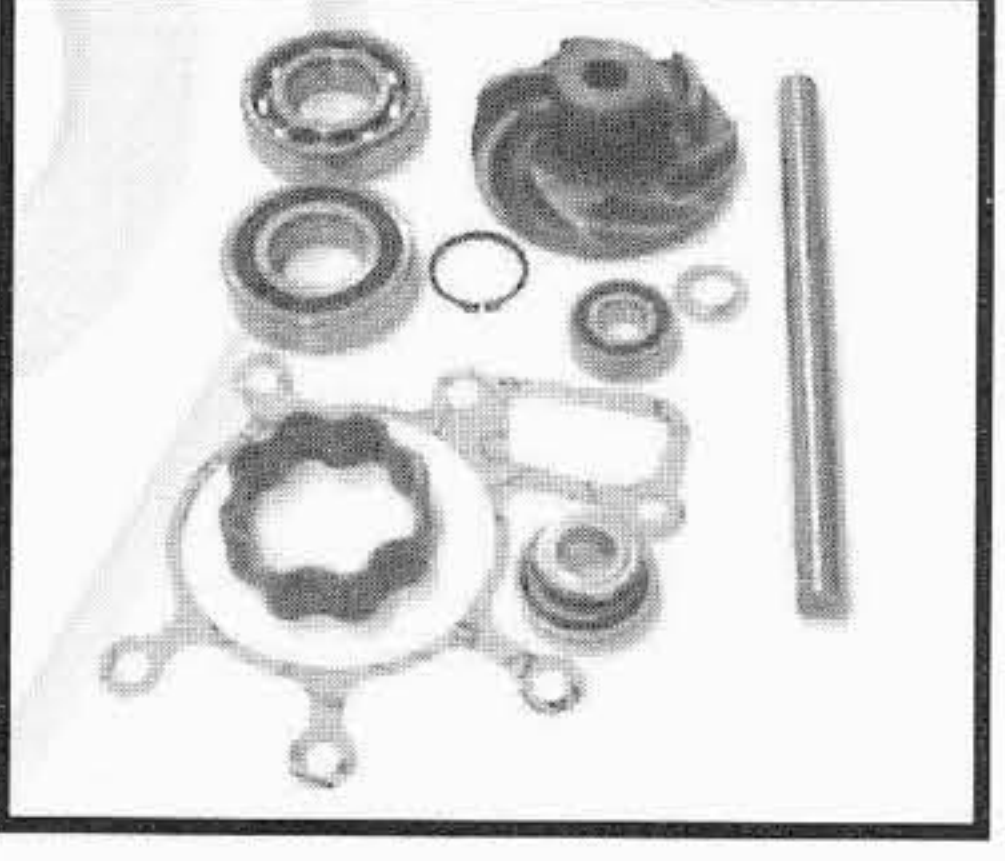
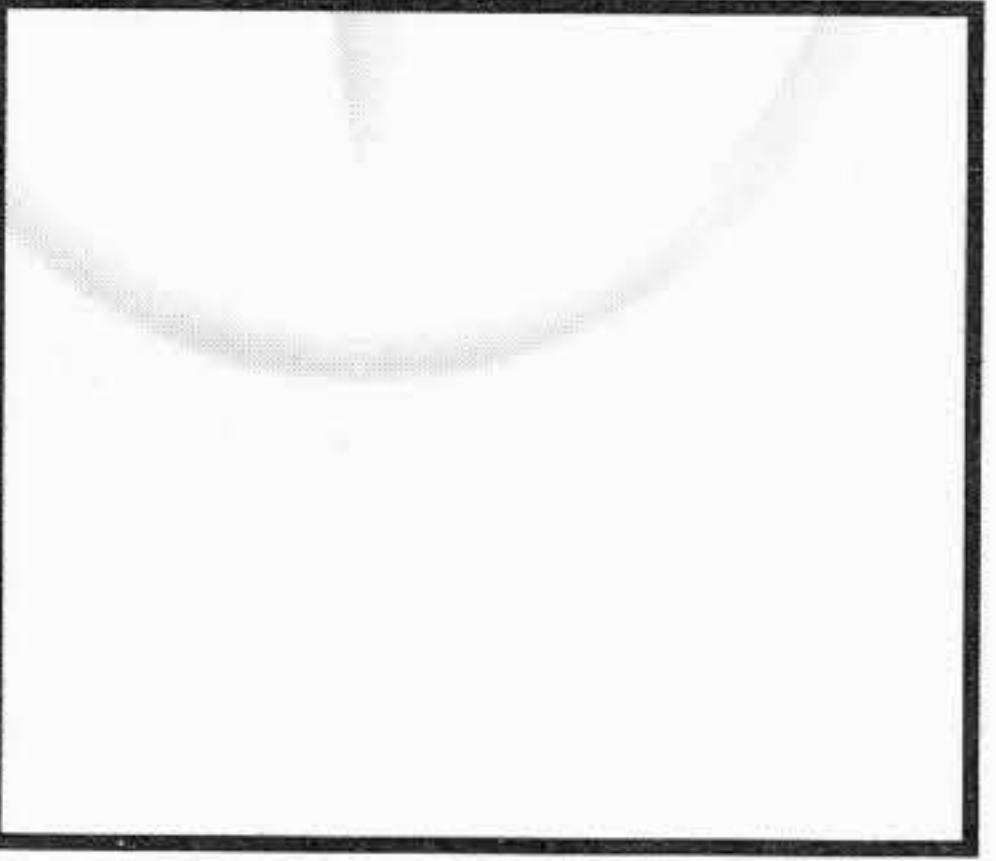
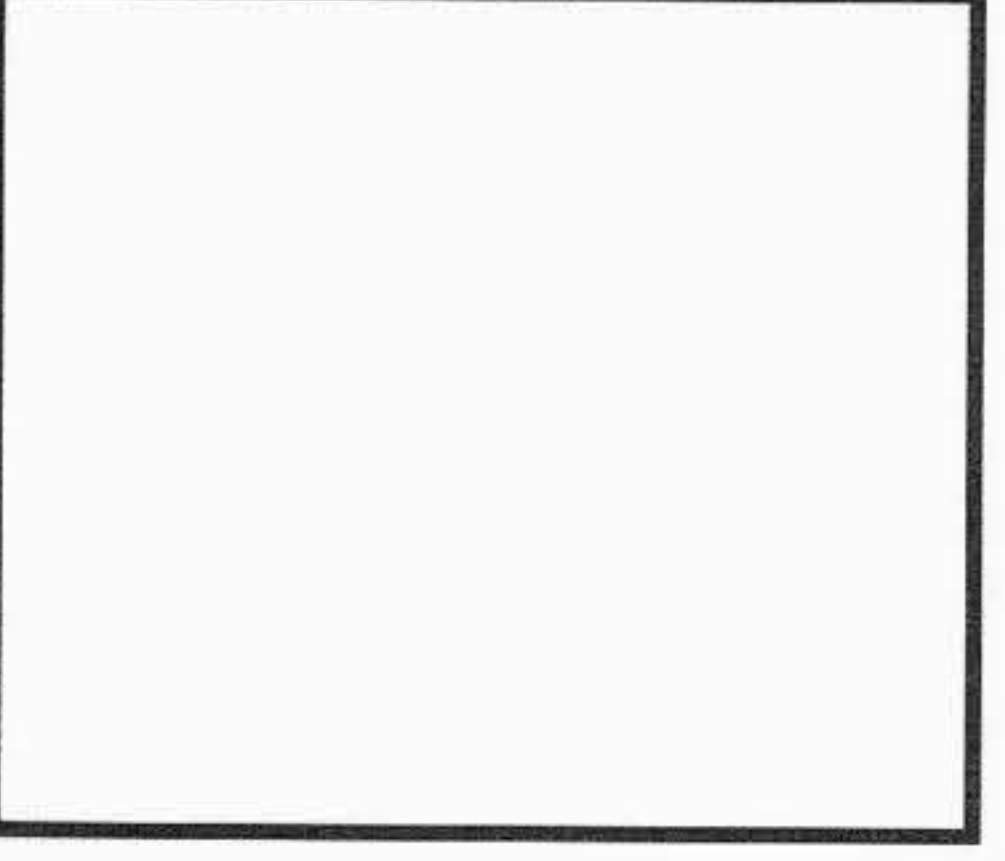
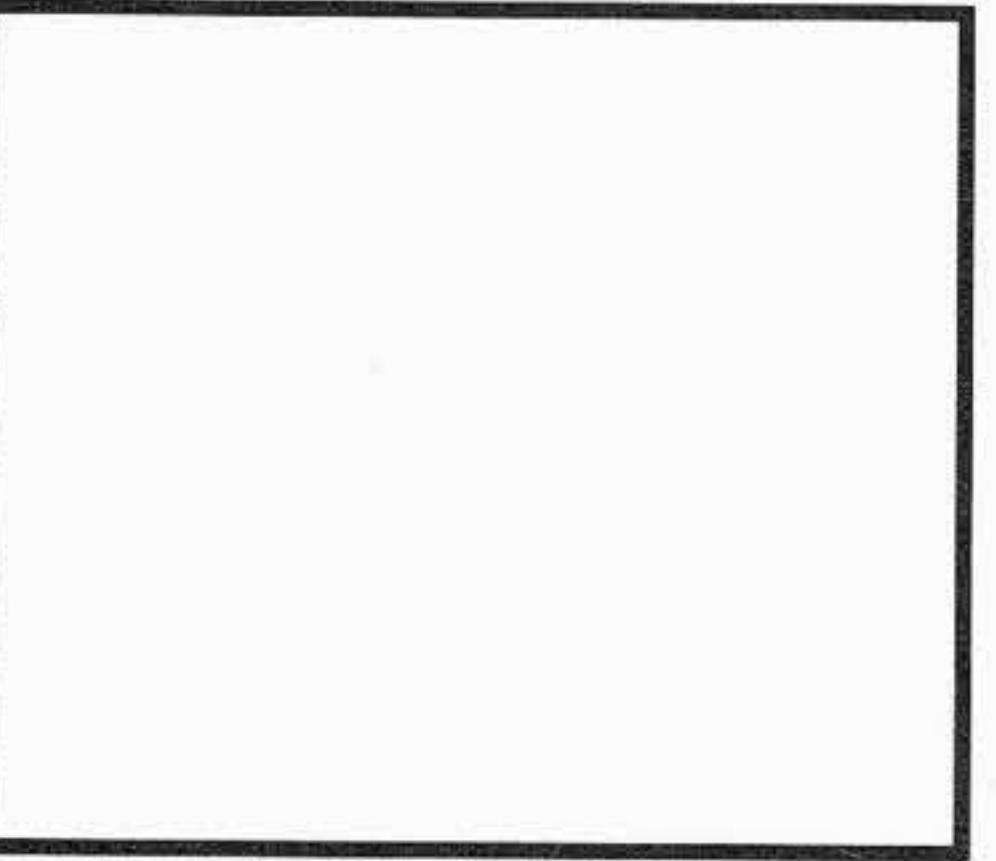
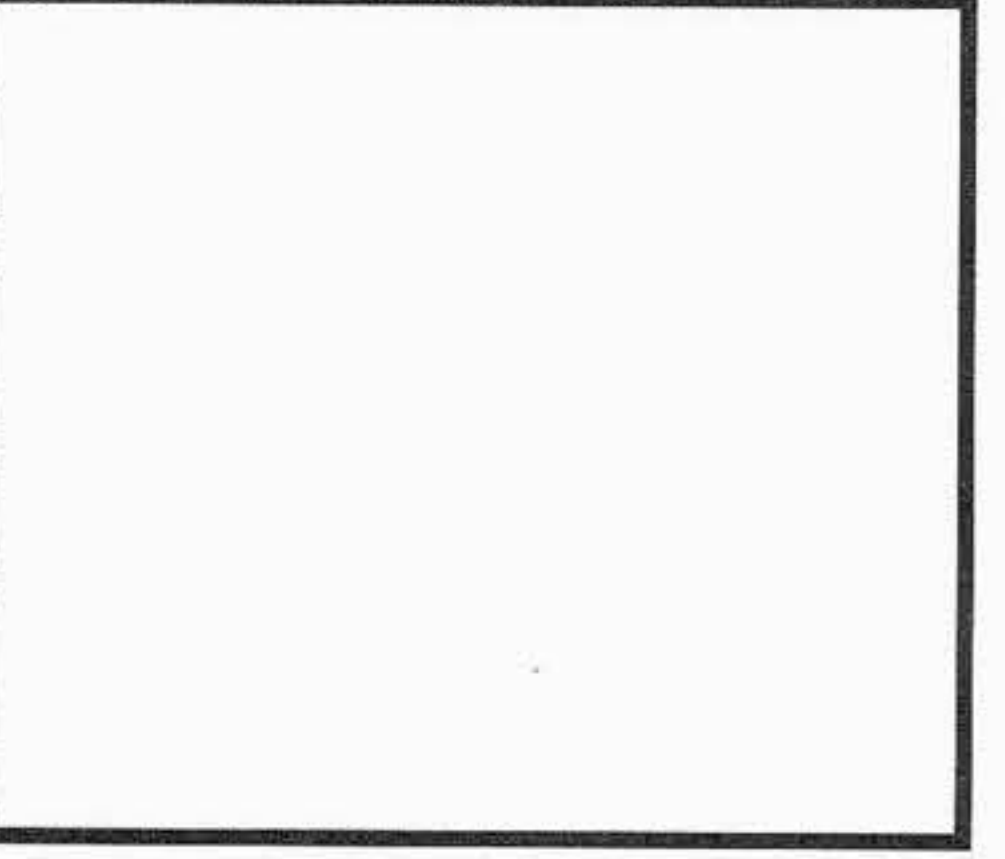

TIPO O MODELLO TYPE OU MODELE TYPE OR MODEL	MOTORE MOTEUR ENGINE	POMPA ACQUA POMPE A EAU WATER PUMP	KIT RIPARAZIONE NECESSAIRE DE REP. REPAIR KIT
LM 621 - LM 622 LM 641 - LM 642 - LM 646 BM 650 LM 840 - LM 841	D 42 A D 45 D 45 B		312.283 11701.095  EX 754.569
BM 650 TURBO BM 700 BM 646 BM 615B L 50 L 70 4200 B			312.284 11701.087  EX 6630.337
BM 800 BM 810 BM 861 BM 2650 BM 4400 BM 4400 S BM 4400 C BM 4500 BM 4500 S	TD 60 B TD 70 H		312.288 11701.442  EX 630.590 - 6630.830 11000.108
			

I ricambi non sono originali ma adattabili . Ogni riferimento originale é assolutamente indicativo .
 Spare parts are not original but perfectly suitable . Every original part number has to be considered for reference purpose only .



SECTION 41/3

APPLICATION

VOLVO
PENTA

INDUSTRIAL ENGINES

WATER PUMPS WASSERPUMPEN
POMPE A EAU BOMBA DE AGUA
POMPA ACQUA

S.P. WATER PUMPS LTD
18 Tatton Court, Kingsland Grange, Woolston,
Warrington, Cheshire. ENGLAND. WAI 4RR
TEL: +44(0) 1925 850082 Fax: +44(0) 1925 850083
Email:sales@spwaterpumps.co.uk Web Site:www.spwaterpumps.co.uk



SECTION 4113

APPLICATION

VOLVO
PENTA

INDUSTRIAL ENGINES

WATER PUMPS WASSERPUMPEN
POMPE A EAU BOMBA DE AGUA
POMPA ACQUA

S.P. WATER PUMPS LTD
18 Tatton Court, Kingsland Grange, Woolston,
Warrington, Cheshire. ENGLAND. WAI 4RR
TEL: +44(0) 1925 850082 Fax: +44(0) 1925 850083
Email:sales@spwaterpumps.co.uk Web Site:www.spwaterpumps.co.uk

SUITABLE

VOLVO



PENTA

MOTORI

Tel:+44(0)1925 850082 Fax: +(0)44 1925 850083

www.spwaterpumps.co.uk

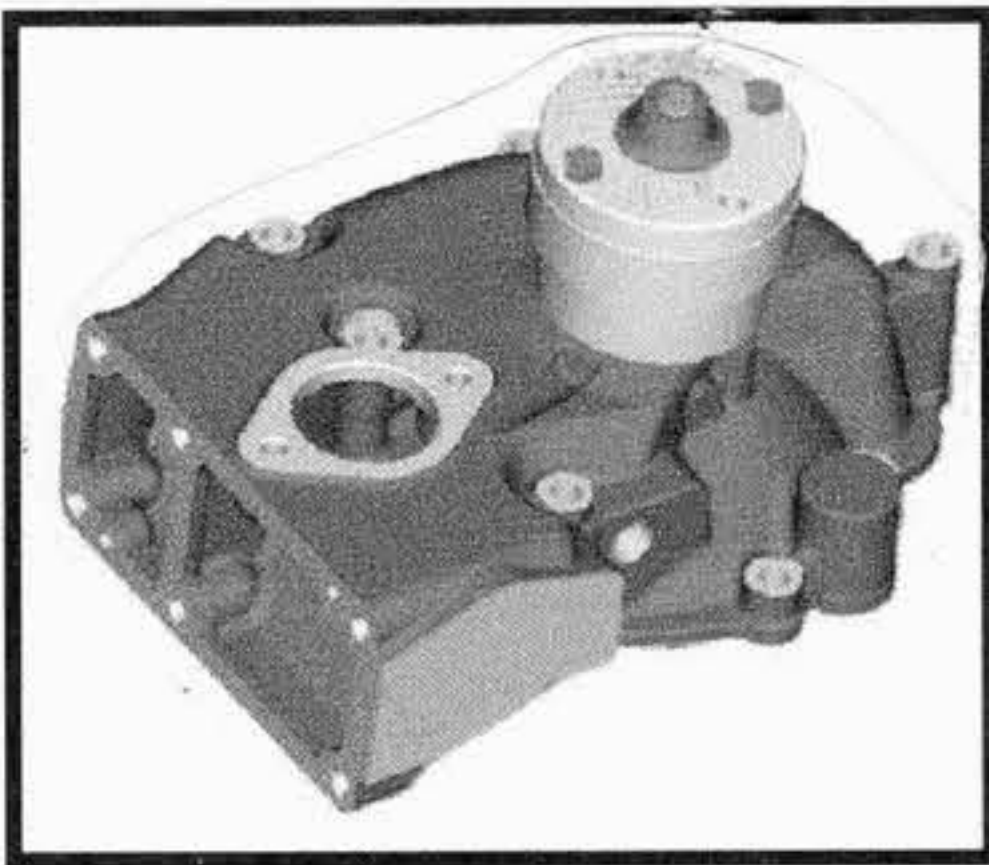
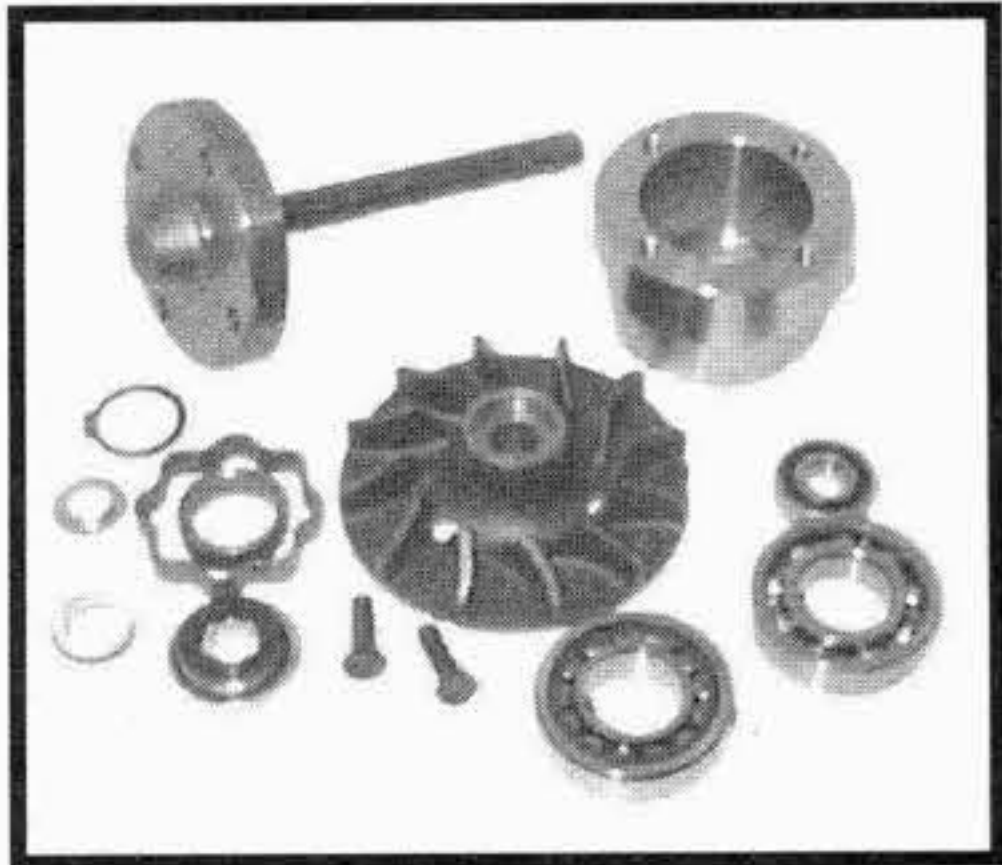
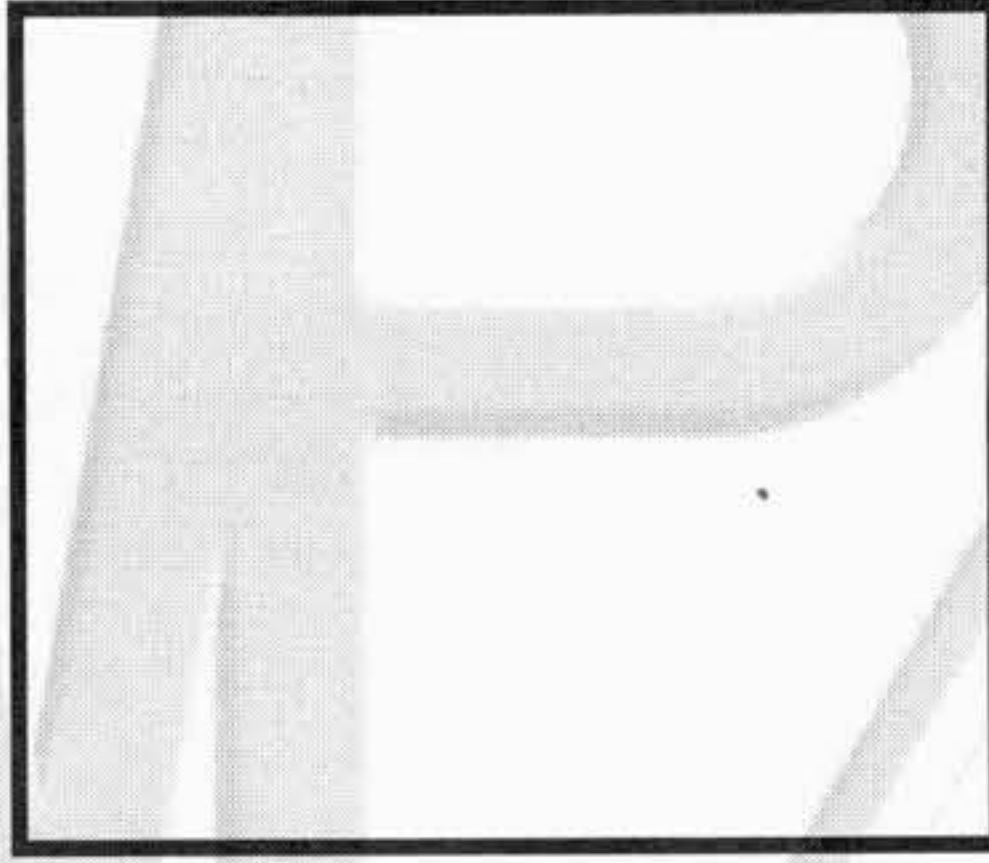
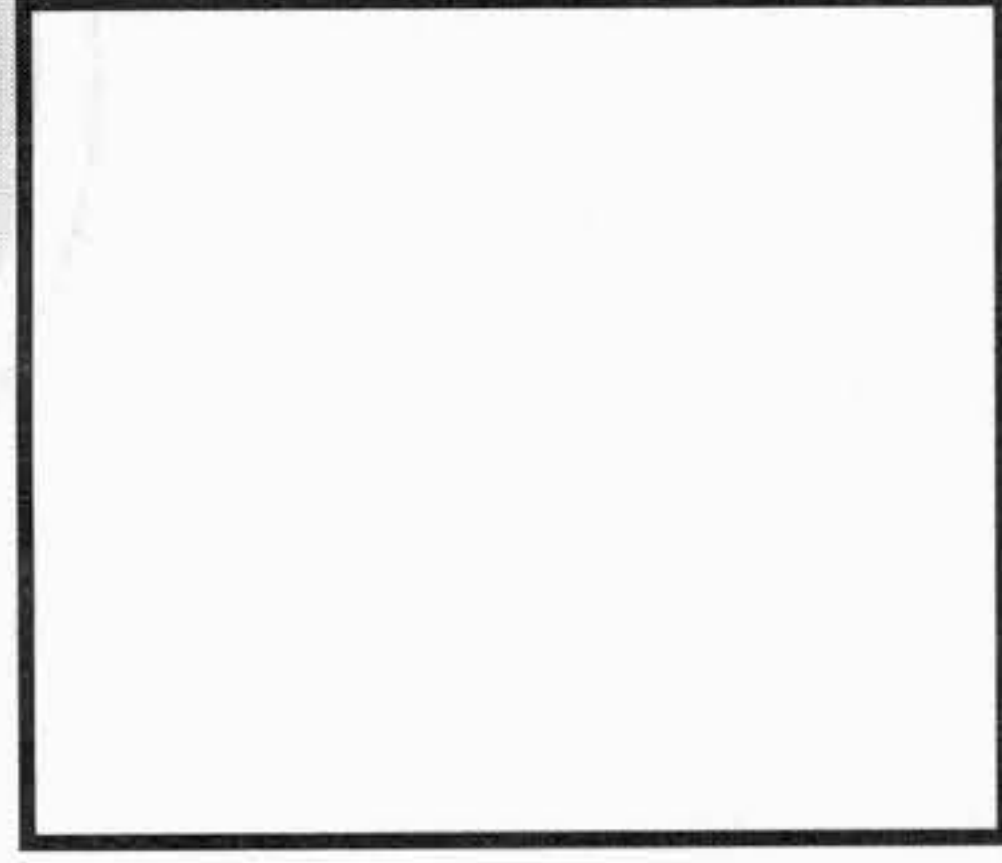
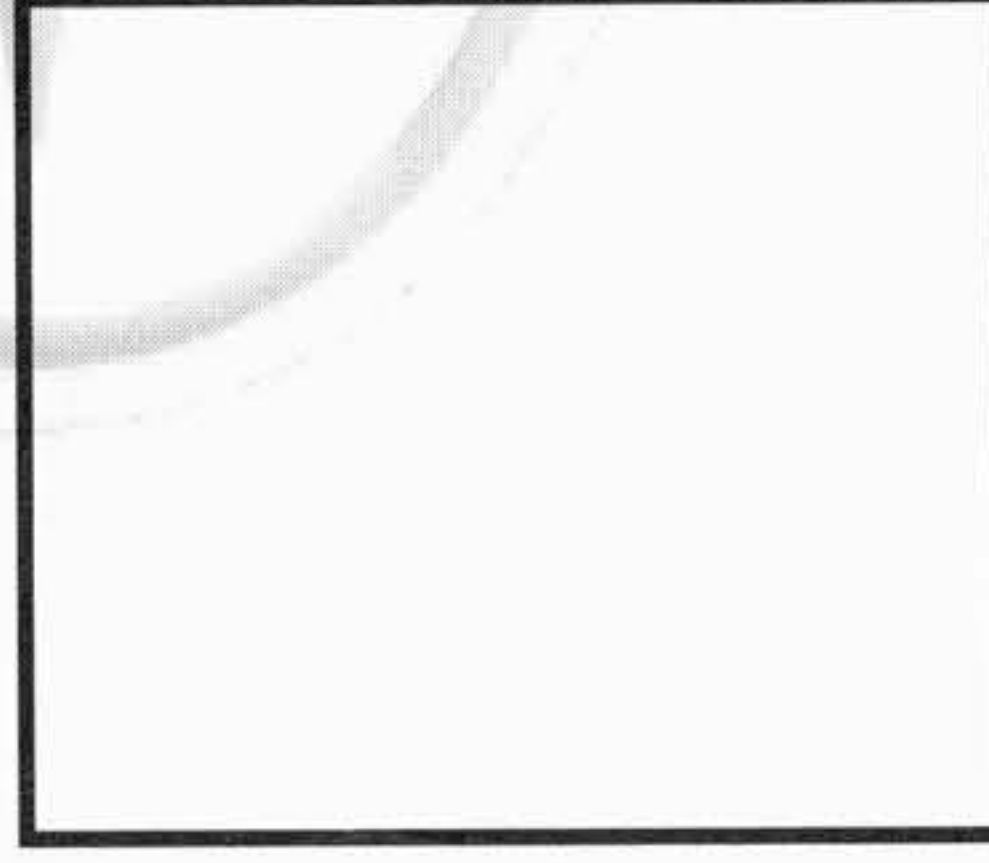

TIPO O MODELLO TYPE OU MODELE TYPE OR MODEL	MOTORE MOTEUR ENGINE	POMPA ACQUA POMPE A EAU WATER PUMP	KIT RIPARAZIONE NECESSAIRE DE REP. REPAIR KIT
		OMP REF. / O.EM. REF	OMP REF. / O.EM. REF
NEW !!	TD 100 G	--- 844.379 	312.290 875.661 
NEW !!	F 4 TD 40 A	317.130 1699.782 	312.177 275.617 
NEW !!	FL 4 TD 41 G	--- 1698.622 	--- --- NON DISPONIBILE NOT AVAILABLE
NEW !!	FLC D4A 135	319.510 --- 	--- --- NON DISPONIBILE NOT AVAILABLE

I ricambi non sono originali ma adattabili . Ogni riferimento originale é assolutamente indicativo .
 Spare parts are not original but perfectly suitable . Every original part number has to be considered for reference purpose only .