

WATER PUMP CATALOGUE

TRUCK & BUS SECTION

ALL MAKES

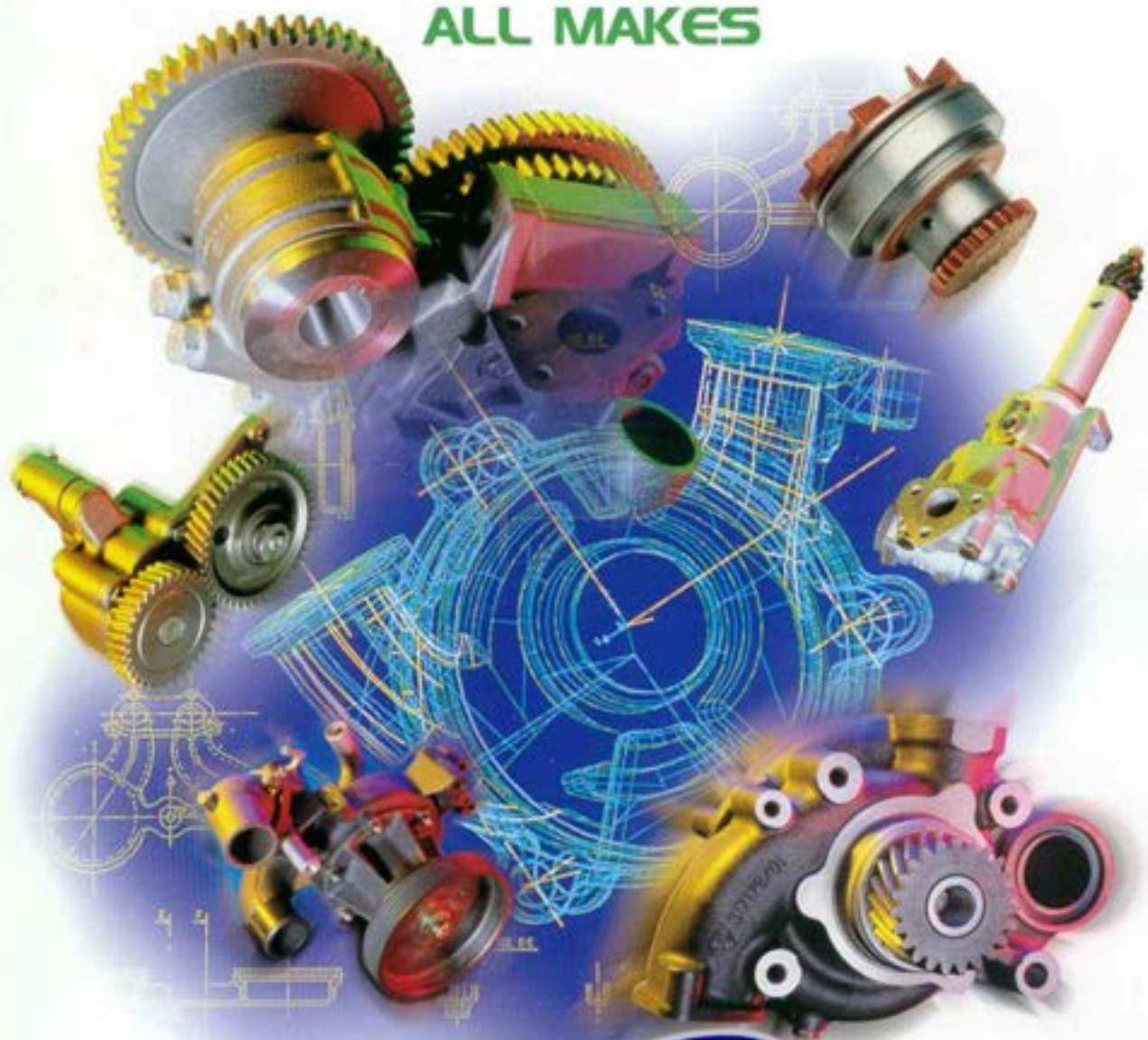

SP

WATER PUMPS

WEB EDITION

S.P. WATER PUMPS LTD

18 Tatton Court, Kingsland Grange, Woolston,
Warrington, Cheshire. ENGLAND. WAI 4RR

TEL: +44(0)1925 850082 FAX: +44(0)1925 850083

Email:sales@spwaterpumps.co.uk Web Site:www.spwaterpumps.co.uk



Tel: +44(0)1925 850082
Fax: +44(0)1925 850083

TRUCK SECTION

WATER PUMP INDEX

AVIA	Section 03
CUMMINS	Section 09
DAF	Section 10
DEUTZ KHD	Section 11
FORD	Section 17
HANOMAG	Section 19
GARDNER	Section 20
IVECO	Section 23
KASSBORER	Section 25
MACK	Section 30
MAN	Section 31
MANITOU	Section 32
MERCEDES BENZ	Section 33
PERKINS	Section 34
RENAULT V.I.	Section 35
SCANIA	Section 37
STEYR	Section 39
VOLVO	Section 41
VOLVO PENTA	Section 41

POPULAR ALL MAKES APPLICATIONS CROSS REFERENCE

MODEL	ENGINE	OEM Ref	SPWP Ref	IVECO Part No	OMP Ref
NTC 290 etc	CUMMINS / ERF etc				
L10 4 Hole Mount	ERF / FODEN / SEDDON etc	C3022474	SP1222	92952630	451-050
L10 3 Hole Mount M11	ERF / FODEN / SEDDON etc	C3801524	SP1233	92952631	None
B Series 6 BTA	ERF / FODEN / SEDDON etc	C3803260	SP1234	92952632	None
C Series 6 CTA	ERF / FODEN / SEDDON etc	C3927015	SP1252	92952633	451-020
	ERF / FODEN / SEDDON etc	C3902971	SP1253	92952634	451-025
MODEL	ENGINE	OEM Ref	SPWP Ref	IVECO Part No	OMP Ref
45, 50, 55 series	DAF				
60, 65 Series	Cummins B Series	CBU2148R	SP1252	92952633	451-020
70 Series	DNT 620	O682956R	SP1314	92952635	405-085
80, 85, 95 Series	DU825, DHR 825, DHU825	O682283R	SP1305	92952636	405-055
80, 85, 95 Series	WS 315G	O682966R	SP1319	92952637	405-070
80, 85, 95 Series	WS 315L	O682960R	SP1320	92952638	405-100
2100, 2300, 2700	DU825, DHR 825, DHU825 Static Fan	O682283R	SP1305	92952636	405-055
2100, 2300, 2700	DU825, DHR 825, DHU825 Elect Fan	O682284R	SP1309	92952640	405-060
2800, 3300, 3600	DKTD, DKST, DKSE 1160 Electric Fan	O682280R	SP1299	92952641	405-075
2800, 3300, 3600	DKTD, DKST, DKSE 1160 Static Fan	O682262R	SP1300	92952642	405-080
SB220	DKLC 1160	O682844R	SP1215	92952643	405-095
MODEL	ENGINE	OEM Ref	SPWP Ref	IVECO Part No	OMP Ref
CARGO 6 Cyl	FORD				
CARGO 4 Cyl	813, 365, 380 DOVER	5008468	SP1423	92952781	None
TRANSIT	2722, 2725, 2728	828F8501ABA	SP1425	92952782	164-145
		5024545	SP1405	92952644	None
MODEL	ENGINE	OEM Ref	SPWP Ref	IVECO Part No	OMP Ref
TQ2734	GARDNER				
	Most Models	TQ2734	SP1450	91952645	450-000
MODEL	ENGINE	OEM Ref	SPWP Ref	IVECO Part No	OMP Ref
G90 4 Cylinder	MAN				
M90 6 Cyl 6870cc	8, 150F, 8, 190F, 8, 153F	51085006443	SP1672	92952648	343-270
L90, M90, L2000, M2000	12, 122F, 14, 192F, 17, 192F	51085996040	SP1673	92952675	343-280
M90, M2000	125mm Impeller	51085006478	SP1675	92952647	343-310
	135mm Impeller	51085006495	SP1676	92952648	343-320
F90, F2000 6 Cyl 11,413cc	6 Cyl V6 Popular Version	51085006408	SP1674	92952649	343-295
F90, F2000 6 Cyl 11,413cc	Later Version With Electronic Drive Inj Pump Fitting	51085006492	SP1677	92952676	343-350
MODEL	ENGINE	OEM Ref	SPWP Ref	IVECO Part No	OMP Ref
7090, 811	MERCEDES				
7090, 811	OM364, OM 364A	3842002001	SP1704	92952650	241-965
814, 914, 1314 etc	OM364, OM 364A WITH METAL GASKET	3842002001-MG	SP1704G	92952677	241-965
814, 914, 1314 etc	OM366, OM366A, OM366LA	3862005901	SP1705	92952651	241-975
815, 1617C	OM366, OM366A, OM366LA WITH METAL GASKET	3862005901-MG	SP1705G	92952678	241-975
815, 1617C	OM366 / LA later Version	3862006801	SP1709	92952652	241-820
	OM366 / LA later Version WITH METAL GASKET	3862006801-MG	SP1709G	92952679	241-82
400 SERIES	OM441LA, OM442LA	4032007601	SP1711	92952653	241-875
400 SERIES	OM401, 402, 421, 422, 423, 441, 442	4032007101	SP1707	92952654	241-835
400 SERIES	OM407, 427, 447	4032007301	SP1708	92952680	241-895
1831, 1835, 1840, 1843 1848, 1853, 1857	ACTROS OM501LA	5422000501	SP1717	92952655	241-855
	ACTROS OM502LA	5422000601	SP1718	92952656	241-860
MODEL	ENGINE	OEM Ref	SPWP Ref	IVECO Part No	OMP Ref
PHASOR	PERKINS				
6954-4	ERF / FODEN / SEDDON / DODGE / PSV etc	4131E11	SP1755	92952657	159-500
	ERF / FODEN / SEDDON / DODGE / PSV etc	41313047	SP1752	92952658	159-260
MODEL	ENGINE	OEM Ref	SPWP Ref	IVECO Part No	OMP Ref
265L, 300L etc	ROLLS ROYCE				
CONSTRUCTOR	ERF / FODEN / SEDDON etc	OE50010	SP1810	92952659	None
STRATO TX325 etc	ERF / FODEN / SEDDON etc	OE49607	SP1811	92952660	None
	ERF / FODEN / SEDDON etc	OE51145	SP1819	92952661	None
MODEL	ENGINE	OEM Ref	SPWP Ref	IVECO Part No	OMP Ref
DS9	SCANIA				
DS11	92, 93 Series	1336490	SP1860	92952662	295-050
DS11, DSC11, DTC11	111 Series	259005	SP1855	92952661	295-010
DS11, DSC11, DTC11	112, 113 Series	1314406	SP1856	92952663	295-035
D14, DS14	112, 113 Series Later Version with Retarder	1354103	SP1862	92952662	295-100
DS14, DSC14	140, 141, 146 Series	1375837	SP1857	92952664	295-020
DS14, DSC14	142, 143 Series	1375838	SP1858	92952665	295-070
DS14, DSC14	142, 143 Series Later Version With Retarder	1375839	SP1859	92952666	295-110
DSC9, 11, 12, 13, 15	94 Series All Models	1380897	SP1870	92952799	295-120
DSC11, 12	114 Series / 124 Series All models	1353072	SP1871	92952800	295-130
DSC14, 13, 15	144 Series All Models	1385841	SP1872	92952801	295-140
MODEL	ENGINE	OEM Ref	SPWP Ref	IVECO Part No	OMP Ref
F8	VOLVO				
FL6, FL7, B6	TD60B, TD60A, TD60C, D60 125mm Dia Pulley	1699783	SP1936	92952683	317-110
F10, F12, FL10, FL12	TD 61, TD 63, TD63E, TD 71, TD71G, TD73, B6	8112185	SP1930	92952687	317-175
FH12	TD102, TD103, TD103E/ES, TD123E, TD123ES	8112638	SP1916	92952688	317-240
F16, FH16	D12A Fitted With Coolant Filter	8112775	SP1935	92952689	317-250
	TD162, TD162F, TD162FL, TD163F, TD163FL, D16A	8149980	SP1934	92952670	317-270
	VOLVO PSV				
B10M MK1	TDH100A, TDH100AD, HD100A,	8112775	SP1911	92952671	317-080
B10M MK11	THD101G, THD101GD, THD101K	8112355	SP1932	92952672	317-180
B10M MK111	TDH101KE, TDH102KB/KDKK, TDH103KB/KDKAF	8112356	SP1933	92952673	317-290
Volvo Olymian MK11	B12, TD102KF	8112849	SP1917	92952674	317-300







SECTION 09



APPLICATION



CUMMINS

**WATER PUMPS WASSERPUMPEN
POMPE A EAU BOMBA DE AGUA
POMPA ACQUA**

**S.P. WATER PUMPS LTD
18 Tatton Court, Kingsland Grange, Woolston,
Warrington, Cheshire. ENGLAND. WAI 4RR
TEL: +44(0) 1925 850082 Fax: +44(0) 1925 850083
Email:sales@spwaterpumps.co.uk Web Site:www.spwaterpumps.co.uk**

TYPE OR MODEL	ENGINE	WATER PUMP	REPAIR KIT
FFC NTC270-CT NTC290 - NTC290R NT310 NTC350 NTC335 NT855-C280 NT855-310 NT855-C355 NTA855-C360	IMPELLER 5-1/4 inches Twin Groove Pulley	<p style="text-align: center;">451.040</p>  <p style="text-align: center;">AR45090—3000886</p>	
		<p style="text-align: center;">451.045</p>  <p style="text-align: center;">AR45182—3022475</p>	
BIG CAM NTC290 NTC350 NTC400 FORMULA 290 FORMULA 350	IMPELLER 4-1/2 inches MULTI VEE PULLEY Diameter 4-11/16 inches	<p style="text-align: center;">451.050</p>  <p style="text-align: center;">C3022474—AR45184</p>	
		<p style="text-align: center;">451.055</p>  <p style="text-align: center;">3801788</p>	

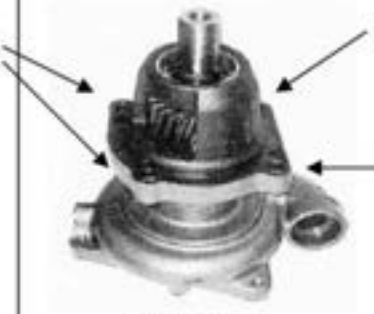
TYPE OR MODEL	ENGINE	WATER PUMP	REPAIR KIT
B SERIES 4CYL - 3900 cc 4B 3.9, 4BT 3.9, 4BTA 3.9 6 CYL - 5900 cc 6B 5.9, 6BT 5.9 6BTA 5.9	6 Ltr B SERIES ERF EC6 Daf 44, 55 Dennis Dart	451.020  3927105	
C SERIES 6 CYL - 8300 cc 6CT8 - 6CTA 8.3	8 Ltr C SERIES ERF EC8 Dennis Javelin	451.025  3913430	
ISB ENGINE 6 CYL - 6 Ltr Fitted With 7 Vane High Output Impeller	ISB ENGINE Iveco Tector Daf LF45, LF55 Late Version Dennis Dart Fitted with ISB	451.021	
ISC ENGINE 6 CYL - 8 Ltr	ISC ENGINE	451.026	

TYPE OR MODEL	ENGINE	WATER PUMP	REPAIR KIT
<p>CUMMINS L10 10 Ltr Engine ERF EC10 LTA10-240, 270, 300</p>	<p>L10 ENGINE 4 Hole Mounting Before 1991 3803402 3801840</p>	<p>ZSP1233</p>  <p>C3801524</p>	
<p>CUMMINS M11 11 Ltr Engine C3803404 ERF EC11 L10-310E L10-330E MTA11-330E Used on a 2 Belt System</p>	<p>LONG SHAFT 65 mm 3 Hole Mounting 1991 & After 3803403</p>	<p>ZSP1234</p>  <p>65 mm</p> <p>C3800737</p>	
<p>CUMMINS M11 11 Ltr Engine SHORT SHAFT VERSION - 30 mm C3800754 Late Version ERF EC11 ECX11</p>	<p>SHORT SHAFT 30 mm 3 Hole Mounting</p>	<p>ZSP1235</p>  <p>30 mm</p> <p>C3800754</p>	



SECTION 10

APPLICATION

DAF

**WATER PUMPS WASSERPUMPEN
POMPE A EAU BOMBA DE AGUA
POMPA ACQUA**

S.P. WATER PUMPS LTD
18 Tatton Court, Kingsland Grange, Woolston,
Warrington, Cheshire. ENGLAND. WAI 4RR
TEL: +44(0) 1925 850082 Fax: +44(0) 1925 850083
Email:sales@spwaterpumps.co.uk Web Site:www.spwaterpumps.co.uk

TAVOLE DI CONVERSIONE
TABLE DE CONVERSION
CONVERSION TABLE

DAF -



NUMERO ORIGINALE NUMERO ORIGINAL ORIGINAL NUMBER	NUMERO SOSTITUTIVO REPLACE PAR NUMERO REPLACED BY NUMBER	RIFERIMENTO REFERENCE REFRECE
0076531	0753672	
0078075		405.052
0078508	1285773	
0098140	0753671	
0098141	0753673	
0159612	1256792	
0101760		405.008
0105057		
0105064		
0107446		405.002
0112395		
0113120	0257034	
0159612	1256792	405.054
0161156	0112395	
0176143	0242912	
0192152		
0200146		
0200149	0200146	
0202950		405.018
0210439		405.048
0222833		401.383
0226464		401.284
0226466		401.354
0226574		403.104
0226595		405.011
0228362	0680151	
0237639	0200146	
0240263	0105064	
0240301		405.027
0240315		403.126
0241508	0680189	
0241571		405.001
0241737		405.013
0241738		405.006
0241739		405.005
0242912		
0243806		405.007
0243967		406.074
0245528	0242912	
0246345		
0246356	0246345	
0249939		
0250992	0680148	
0251620		406.163
0251928		401.381
0251929		406.102
0252145	0269044	

NUMERO ORIGINALE NUMERO ORIGINAL ORIGINAL NUMBER	NUMERO SOSTITUTIVO REPLACE PAR NUMERO REPLACED BY NUMBER	RIFERIMENTO REFERENCE REFRECE
0252405		405.039
0252589		405.038
0253541		405.000
0253546		
0257033	0257034	
0257034		
0258566	0105057	
0269044	1270247	
0272508		405.074
0283413	0098140	
0286021	0098141	
0292222	0076531	
0295023	0682258	
0367145		405.029
0384714	0490212	
0490212	CBU1131	
0506089		405.031
0506109	0517097	405.020
0510583	0367145	
0516727	0680191	
0516728		405.022
0517078		405.023
0517097	0628260	
0579722		401.384
0614781		405.025
0624147	0682264	
0633162	0680151	
0635940	0680152	
0646230	VEDI 0680191	405.024
0646232		405.026
0653235		405.033
0680147		
0680148	0680270	
0680151	0680520	
0680152	0680520	
0680153	0680271	
0680156	0682262	405.040
0680188		405.042
0680189		405.003
0680190		405.064
0680191		405.019
0680217	0682263	
0680270	0680521	
0680271	0680520	
0680318	0682561	
0680520		405.045
0680521		405.035

OGNI RIFERIMENTO ORIGINALE E' ASSOLUTAMENTE INDICATIVO. CHAQUE REFERENCE ORIGINAL EST ABSOLUMENT INDICATIVE. EVERY ORIGINAL PART NUMBER HAS TO BE CONSIDERED FOR REFERENCE PURPOSE ONLY.

TAVOLE DI CONVERSIONE
TABLE DE CONVERSION
CONVERSION TABLE

DAF -



NUMERO ORIGINALE NUMERO ORIGINAL ORIGINAL NUMBER	NUMERO SOSTITUTIVO REPLACE PAR NUMERO REPLACED BY NUMBER	RIFERIMENTO OMP REFERENCE OMP OMP REFERENCE
0680947	0682259	
0681163	0682561	
0681198	0680520	
0681460	0682271	
0681605	0682268	
0681653	0682258	
0681735	0682269	
0682215		
0682258	0682968	
0682259		
0682260		405.075
0682262		405.080
0682263		405.055
0682264		405.060
0682268		
0682269	0682293	
0682271		
0682293	0682884	
0682884		405.095
0682958		405.085
0682968		405.070
0753625		405.072
0753671		405.069
0753672		405.068
0753673		405.071
0838049		405.009
1241491		405.063
1244482		405.073
1256792		405.054
1270247		405.032
1285773		405.053
CBU1131	CBU1909	
CBU1909	CBU2148	
CBU2148		1405.020

NUMERO ORIGINALE NUMERO ORIGINAL ORIGINAL NUMBER	NUMERO SOSTITUTIVO REPLACE PAR NUMERO REPLACED BY NUMBER	RIFERIMENTO OMP REFERENCE OMP OMP REFERENCE

OGNI RIFERIMENTO ORIGINALE E' ASSOLUTAMENTE INDICATIVO. CHAQUE REFERENCE ORIGINAL EST ABSOLUMENT INDICATIVE. EVERY ORIGINAL PART NUMBER HAS TO BE CONSIDERED FOR REFERENCE PURPOSE ONLY.

SUITABLE

DAF

Tel:+44(0)1925 850082 Fax: +(0)44 1925 850083

www.spwaterpumps.co.uk

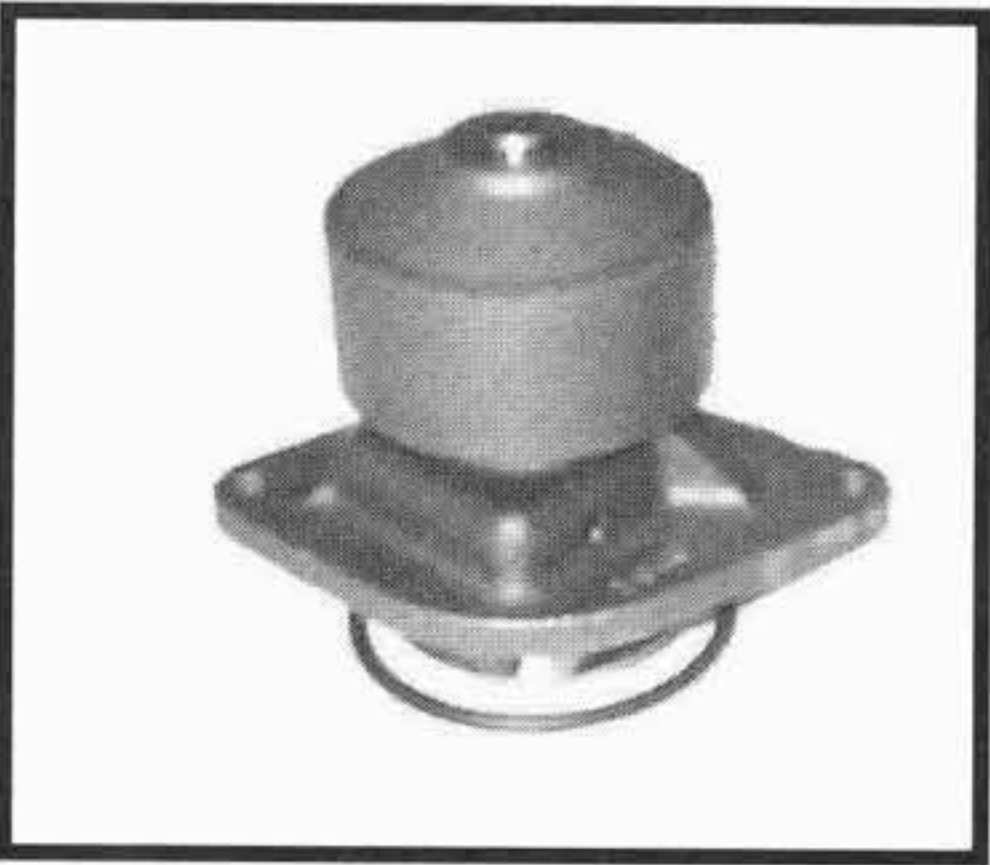
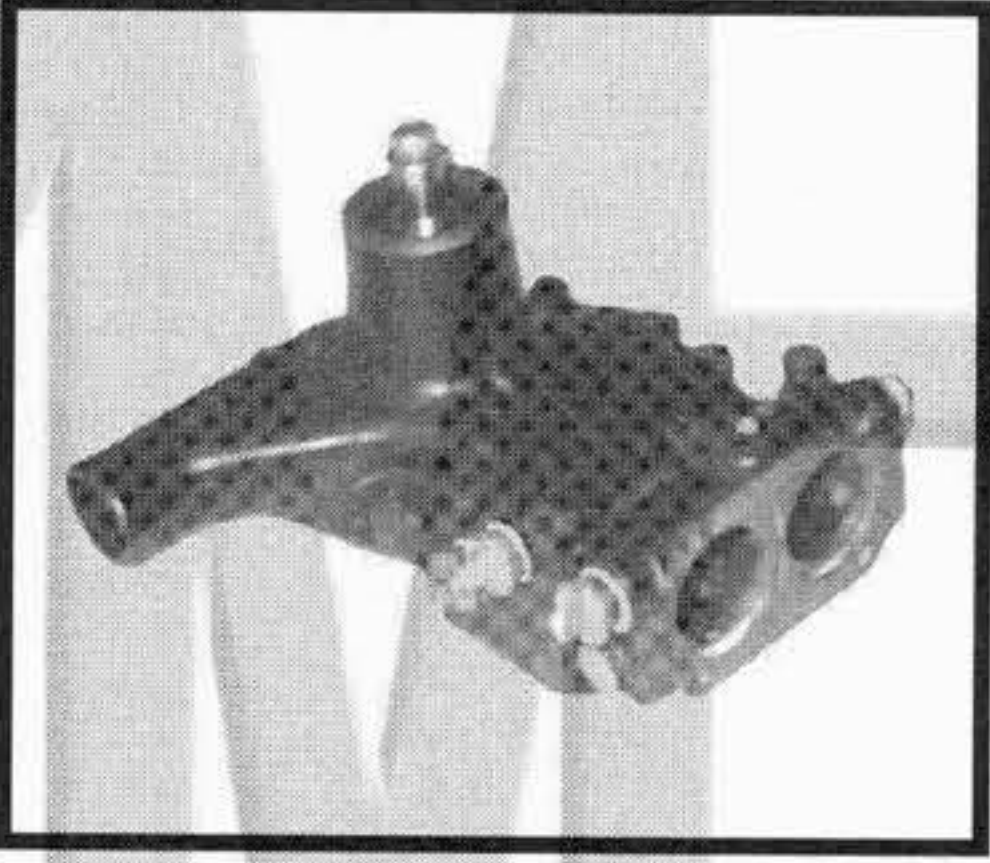
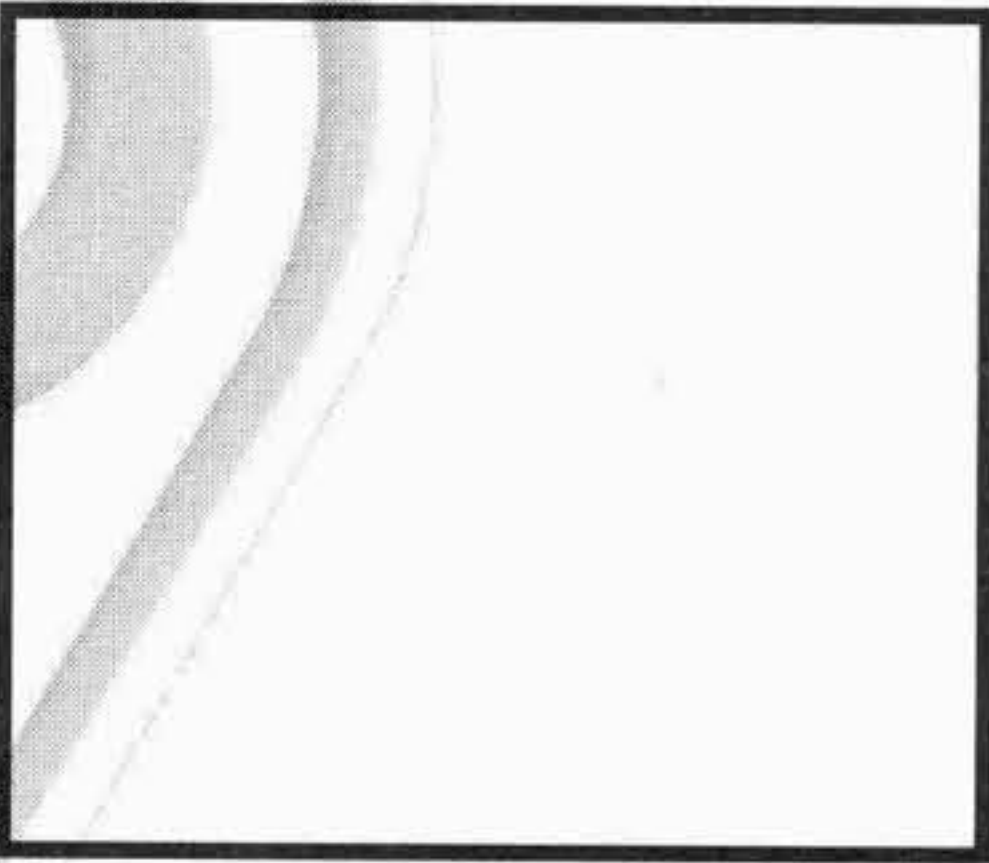
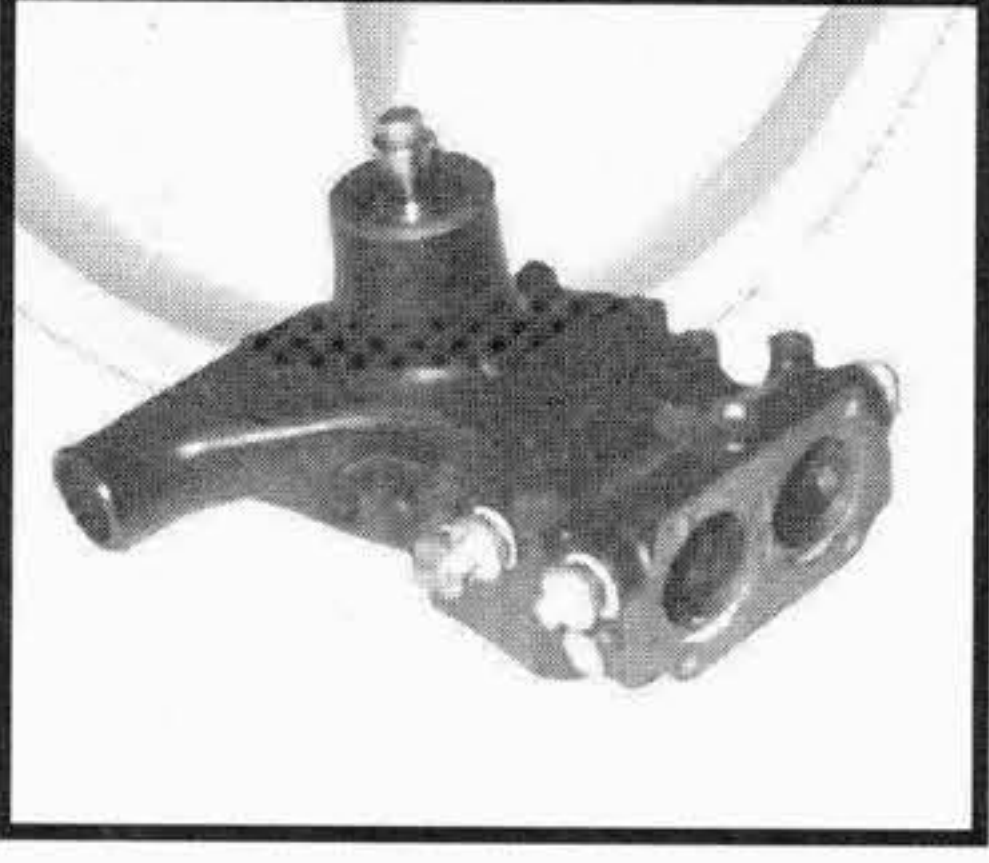
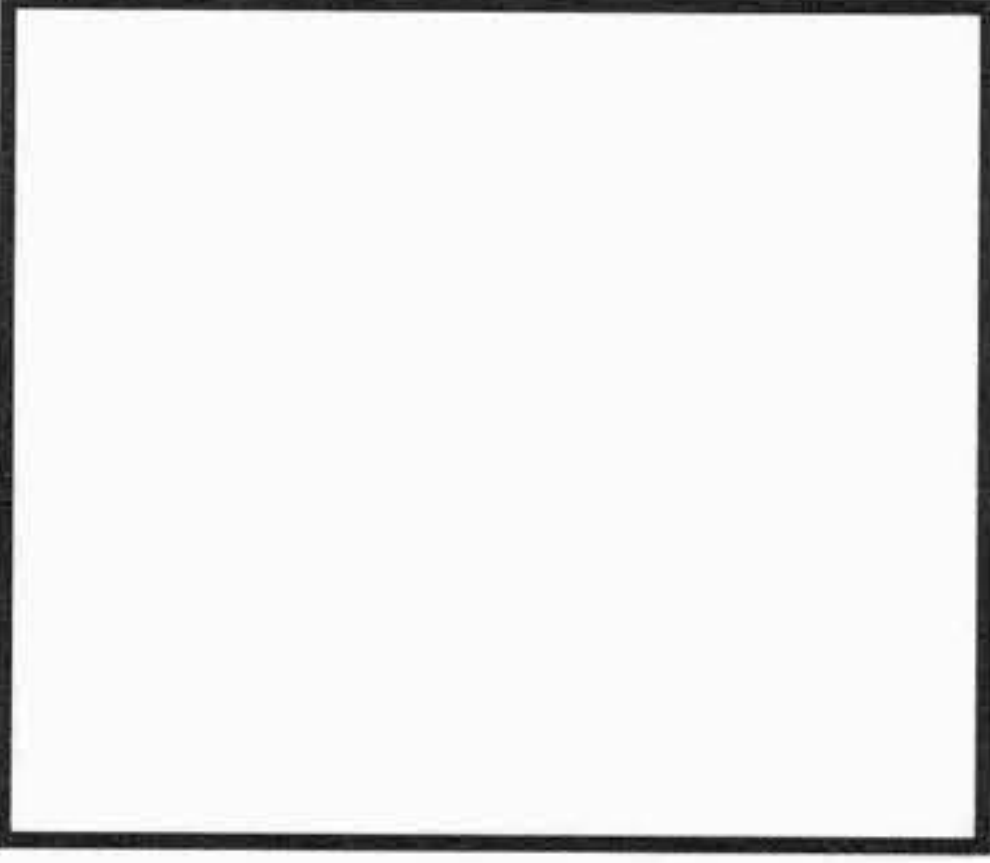
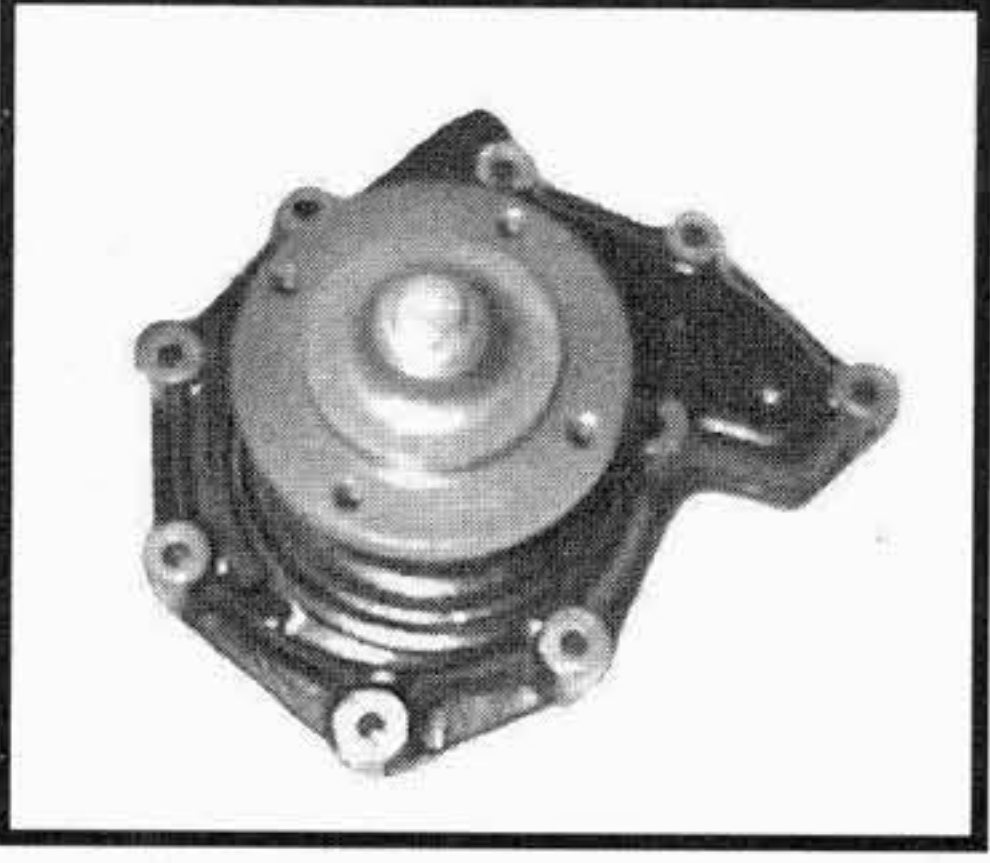
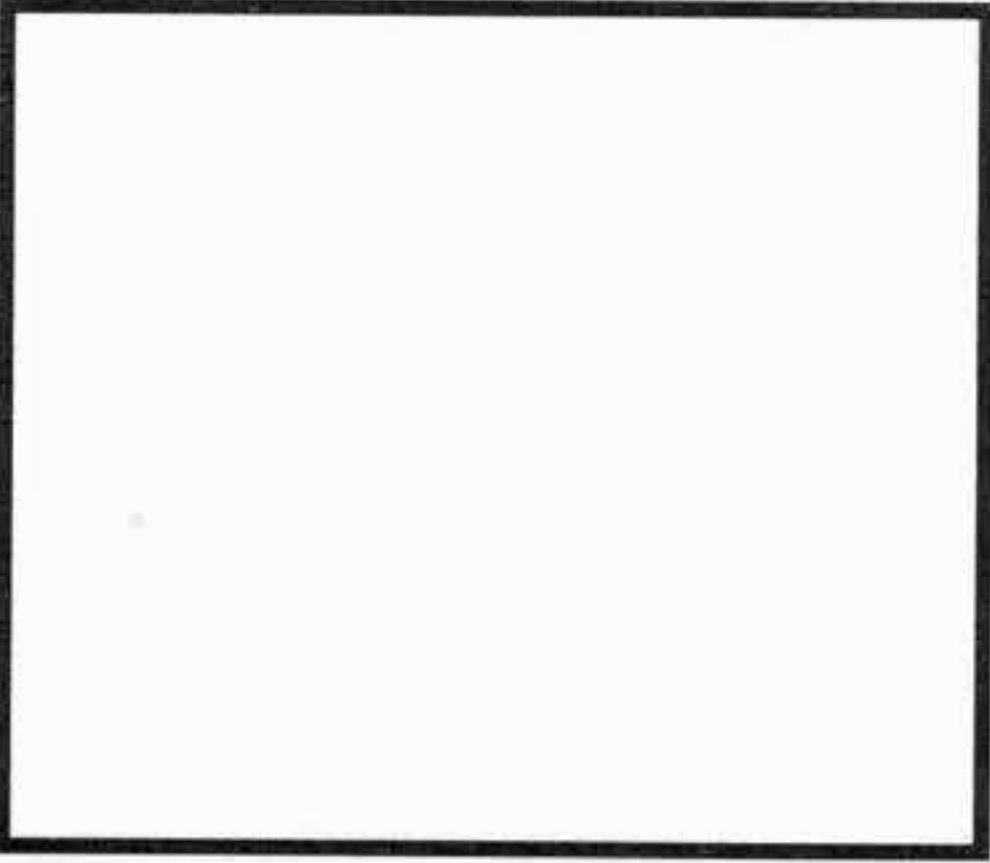

TIPO O MODELLO TYPE OU MODELE TYPE OR MODEL	MOTORE MOTEUR ENGINE	POMPA ACQUA POMPE A EAU WATER PUMP	KIT RIPARAZIONE NECESSAIRE DE REP. REPAIR KIT
<p>600 800 1000</p> <p>NEW !!</p> <p>45 ALL MODELS 55 ALL MODELS</p> <p>LF 45 / 55 - ISB Engine Call for Availabilty</p>	<p>4 CYL. 3.9</p> <p>6 CYL. 5.9</p>	<p>1405.020 CBU2148</p> 	<p>451.021 ---</p> <p>Daf LF45 / 55 ISB Engine Available Soon</p> <p>Call Now +44 (0)1925 850082 for Availability</p>
<p>1100 1300 1600 1800</p> <p>NEW !!</p>	<p>DT 615</p>	<p>405.045 0680520</p>  <p>albero corto short shaft</p>	<p>405.279 ---</p> 
<p>1600 1800</p> <p>NEW !!</p>	<p>DT 615</p>	<p>405.035 0680521</p>  <p>albero lungo long shaft</p>	<p>405.280 ---</p> 
<p>1300 1700 1900 2700</p> <p>65 all models</p> <p>NEW !!</p>	<p>DNT 620 DNTD 620 DNS 620</p> <p>620 NS</p>	<p>405.085 0682958</p> 	<p>405.283 ---</p> 

I ricambi non sono originali ma adattabili . Ogni riferimento originale é assolutamente indicativo .
Spare parts are not original but perfectly suitable . Every original part number has to be considered for reference purpose only .





SUITABLE

DAF

Tel: +44(0)1925 850082 Fax: +(0)44 1925 850083

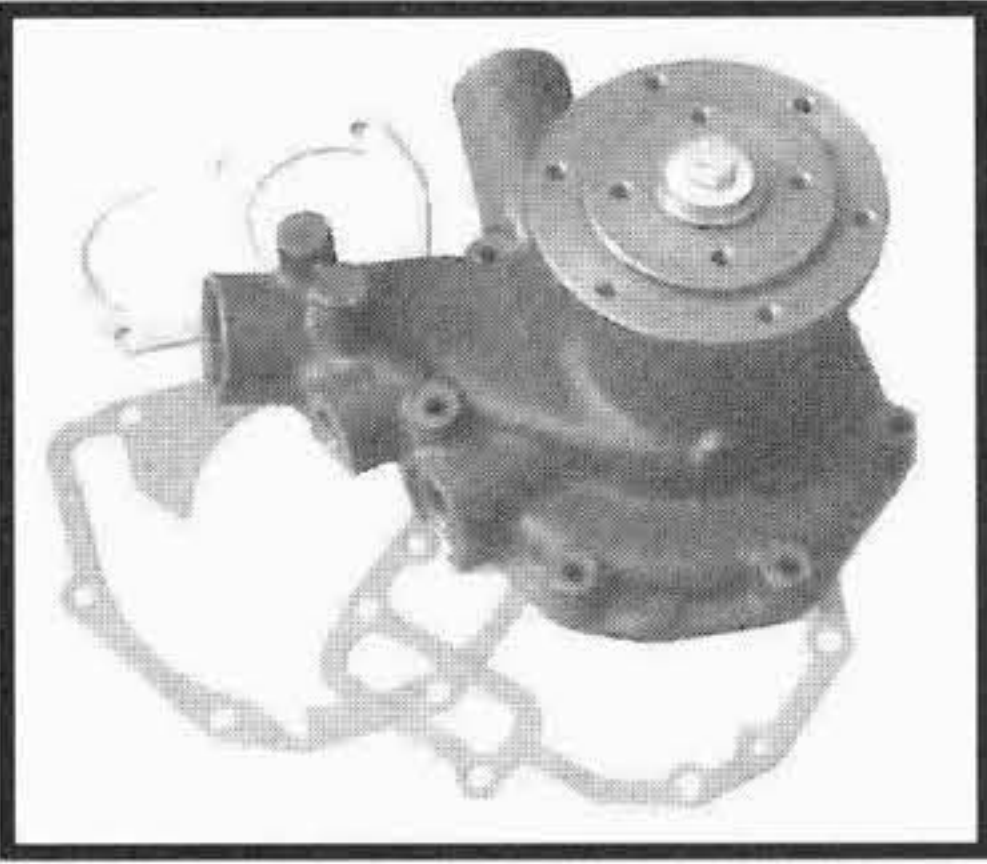
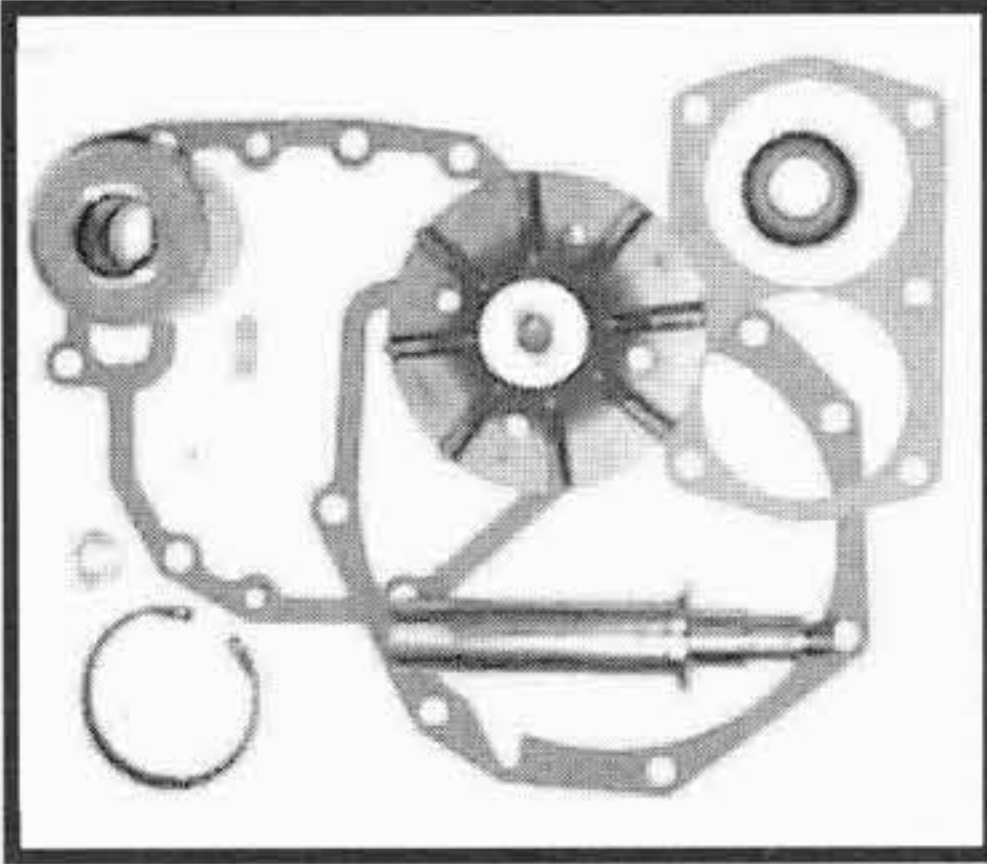
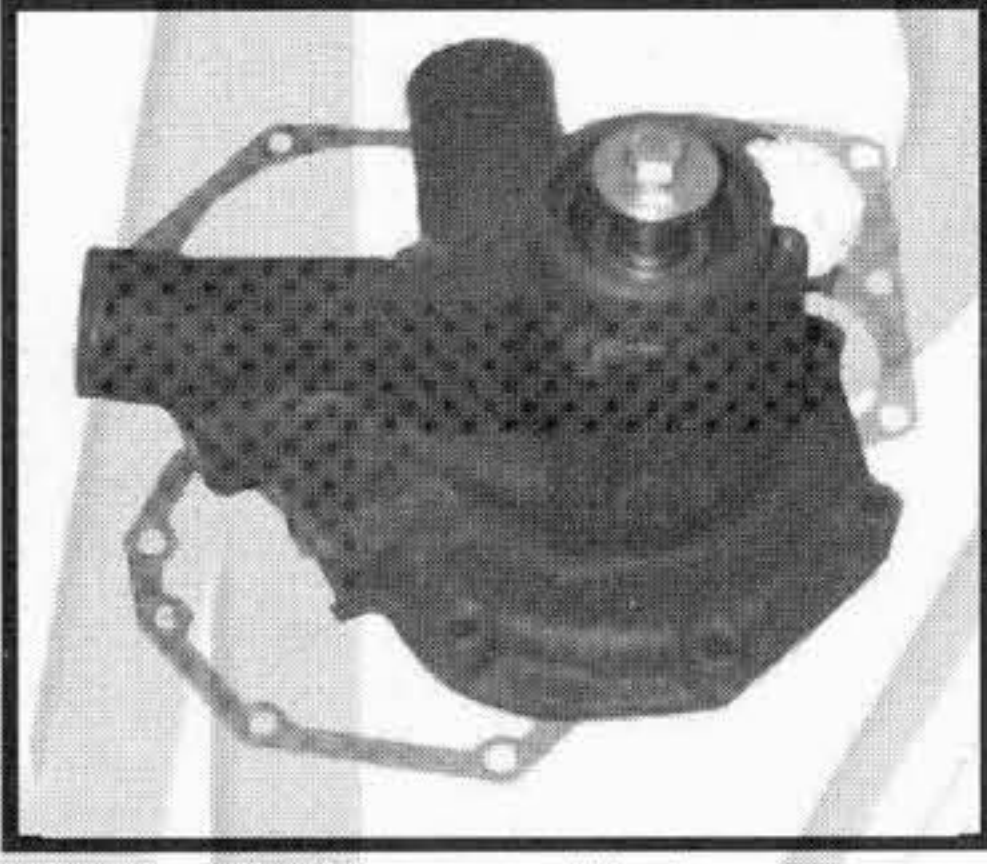
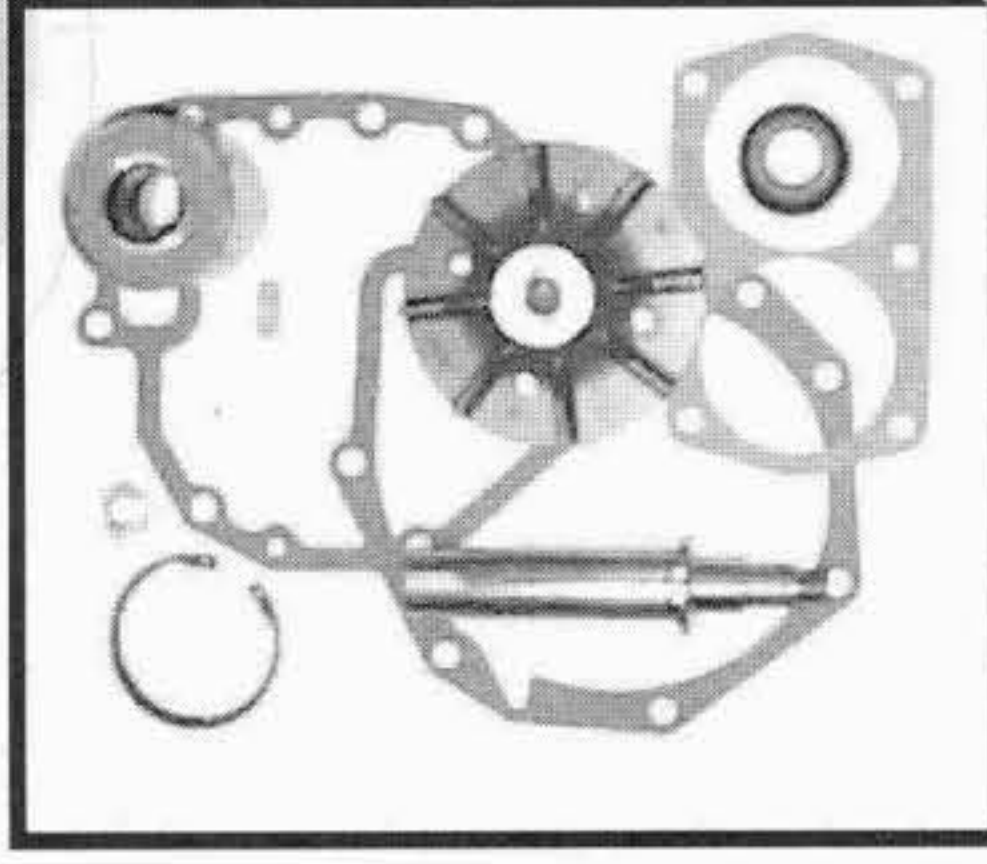
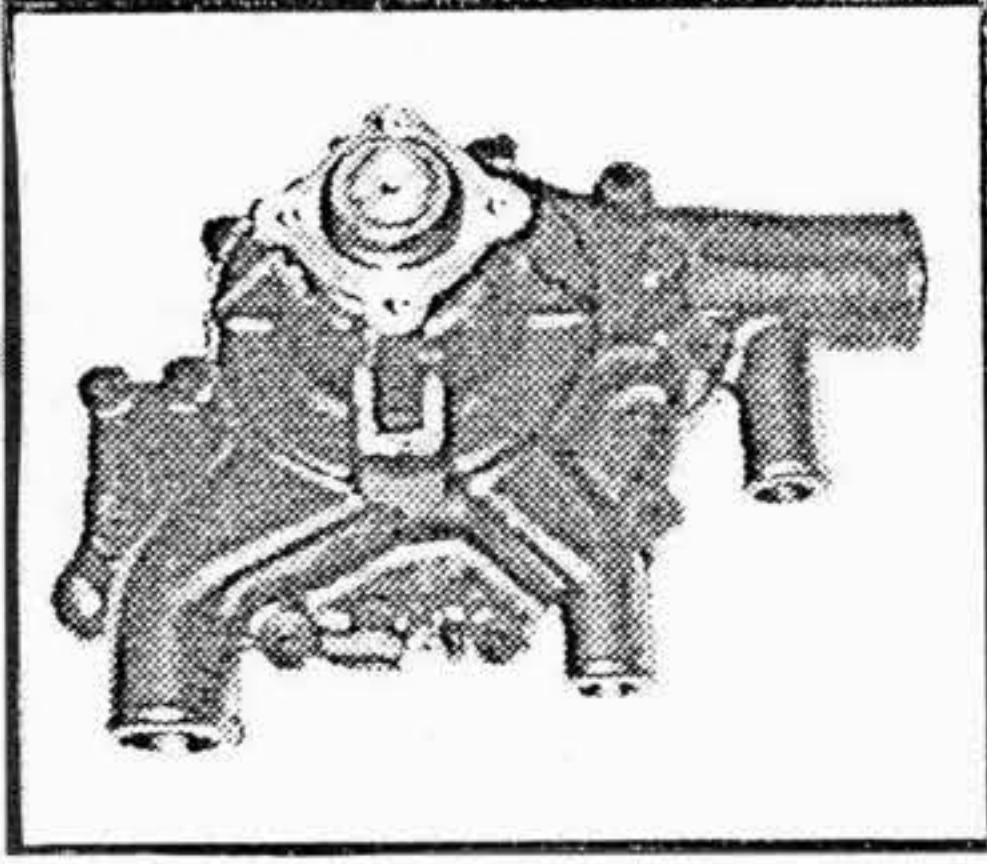
www.spwaterpumps.co.uk

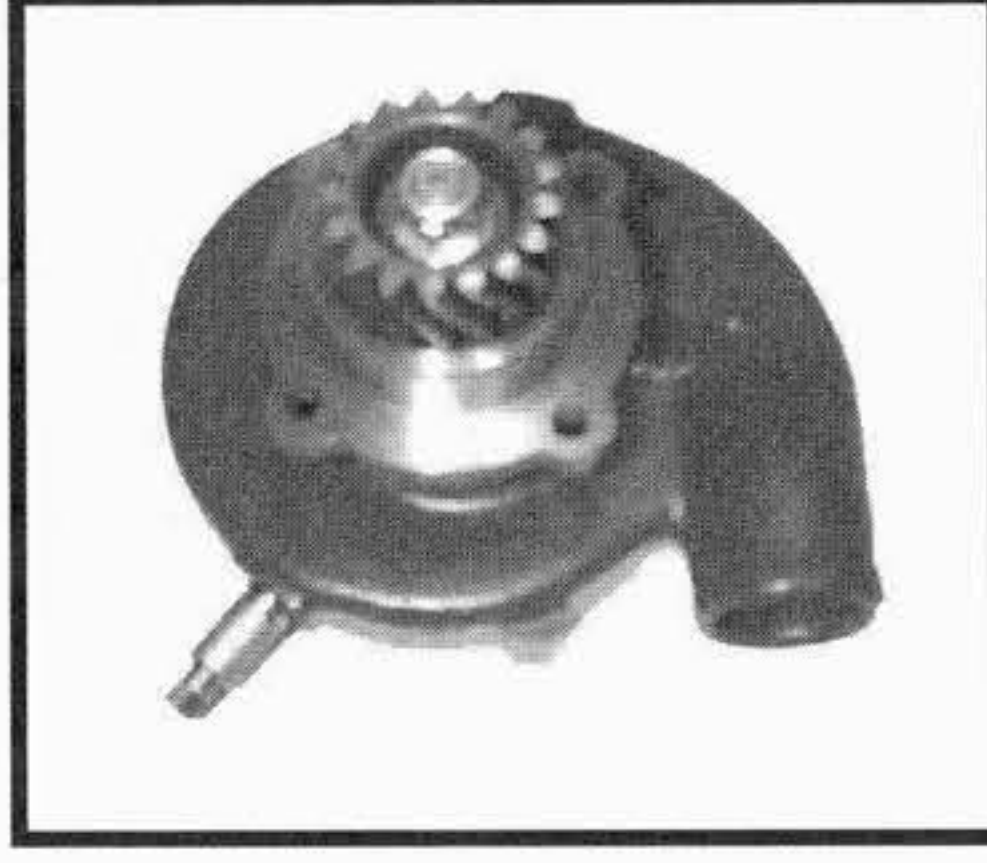

TIPO O MODELLO TYPE OU MODELE TYPE OR MODEL	MOTORE MOTEUR ENGINE	POMPA ACQUA POMPE A EAU WATER PUMP OMP REF. / O.EM. REF	KIT RIPARAZIONE NECESSAIRE DE REP. REPAIR KIT OMP REF. / O.EM. REF
2100 2300 SB 2300 SB 2305 2500	DU 825 DHR 825 DHU 825 SB 2300	<p>405.055 0682263</p> 	<p>405.277 ---</p> 
SB 2000 SB 2005 2100 2300 2500	DU 825 DHR 825 DHU 825	<p>405.060 0682264</p>  <p><i>con elettroventilatore avec ventilateur electric with electric fan</i></p>	<p>405.277 ---</p> 
75 all models NEW !!	865 RS	<p>405.090 0682747</p> 	<p>405.282 ---</p> 
MB 200 - SB 201	DKDL 1160	<p>405.000 0253541</p> 	<p>405.281 ---</p> 

I ricambi non sono originali ma adattabili . Ogni riferimento originale é assolutamente indicativo .
Spare parts are not original but perfectly suitable . Every original part number has to be considered for reference purpose only .



SUITABLE

DAF



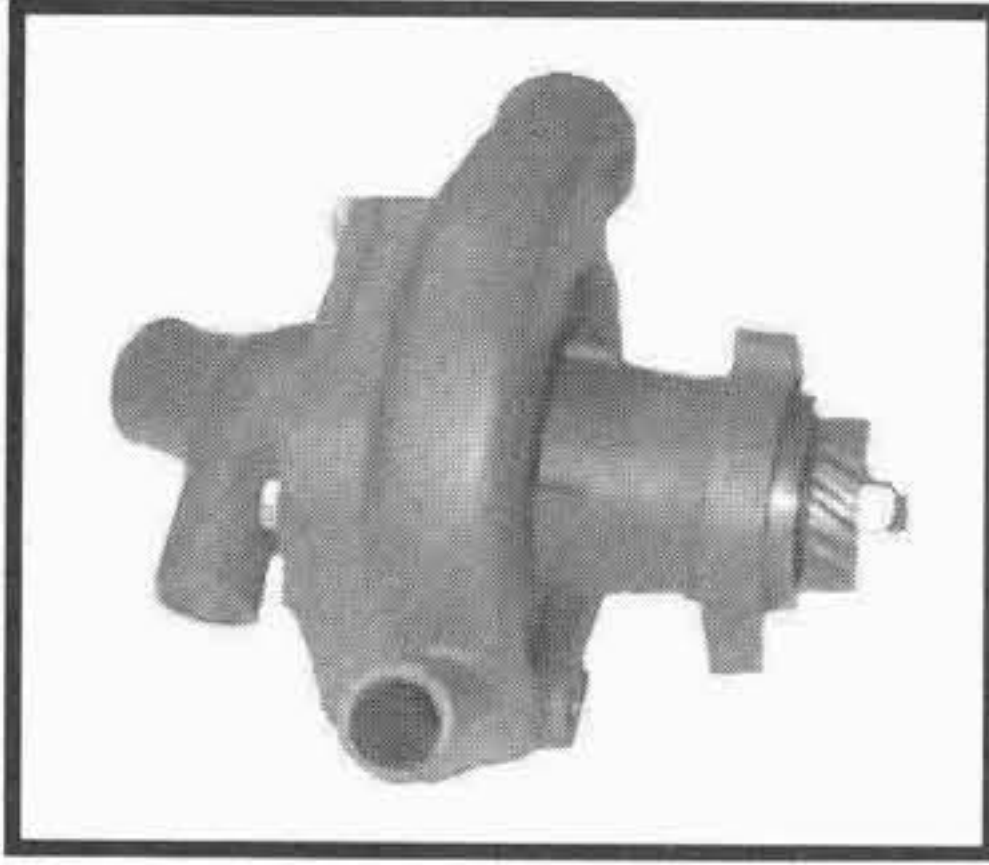

Tel:+44(0)1925 850082 Fax: +(0)44 1925 850083

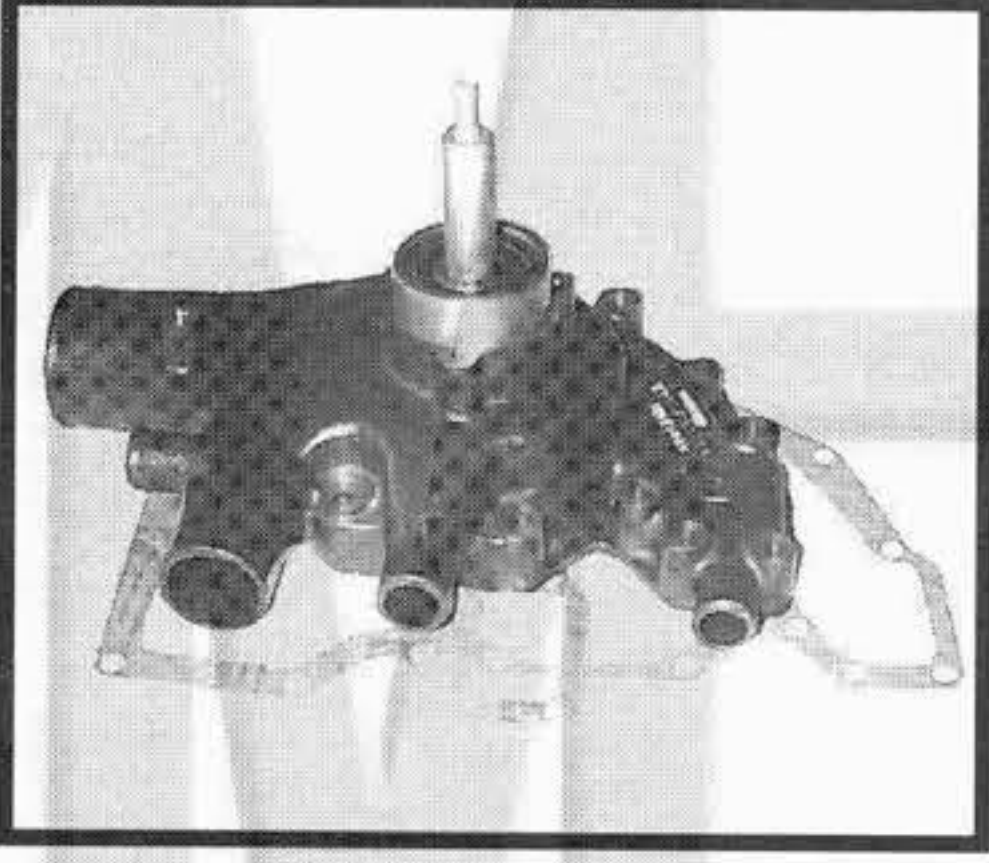
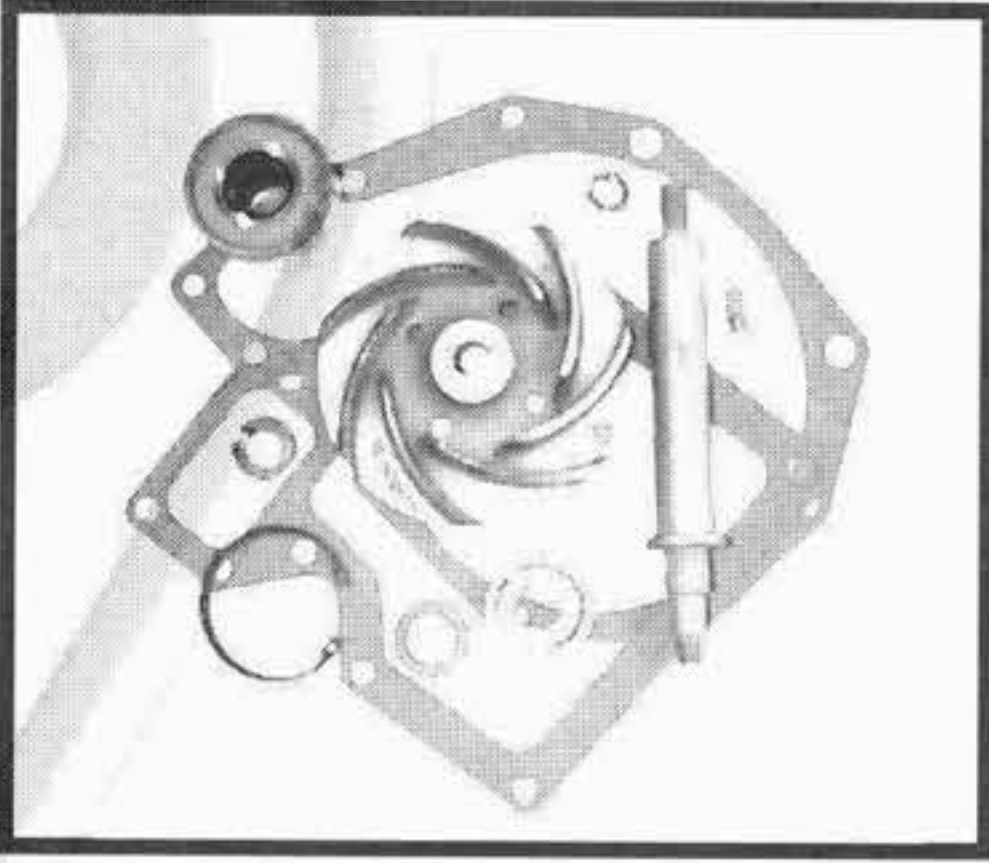
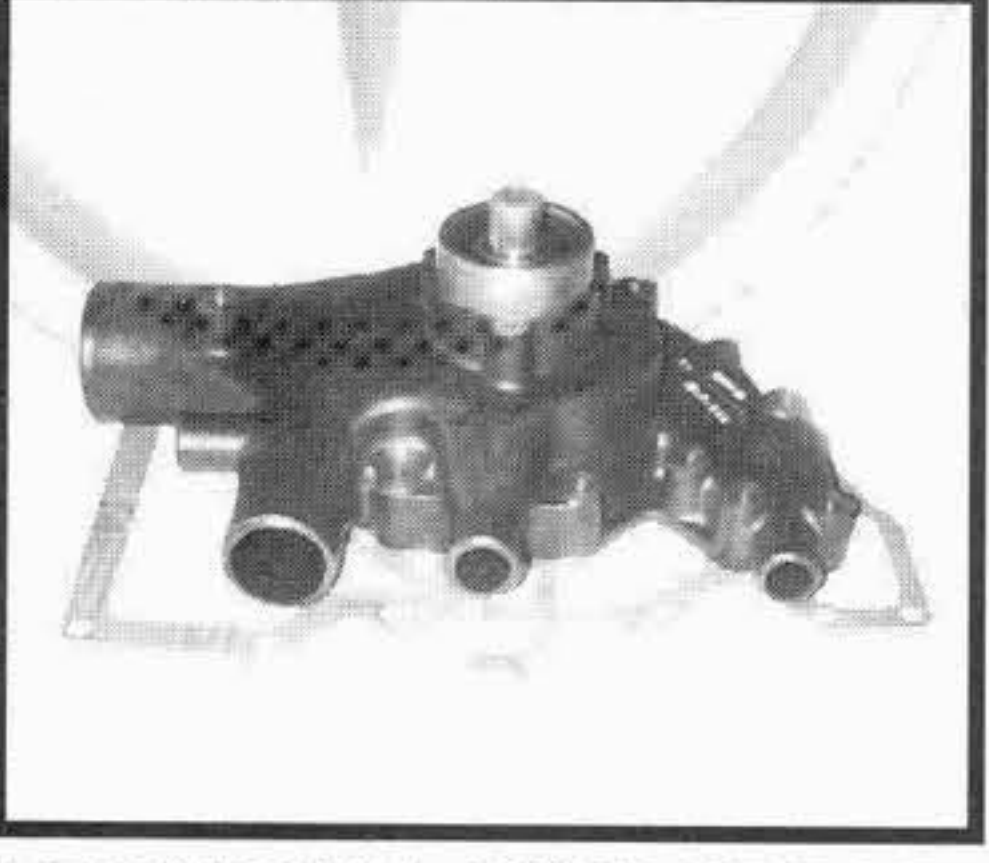
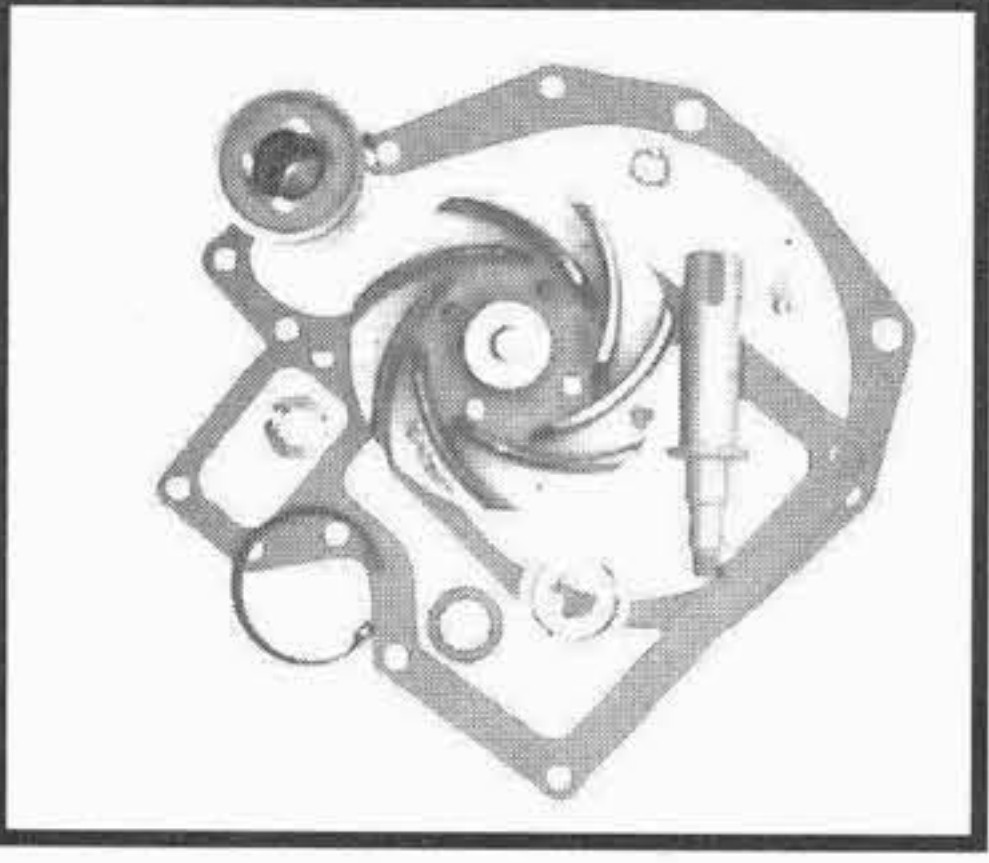
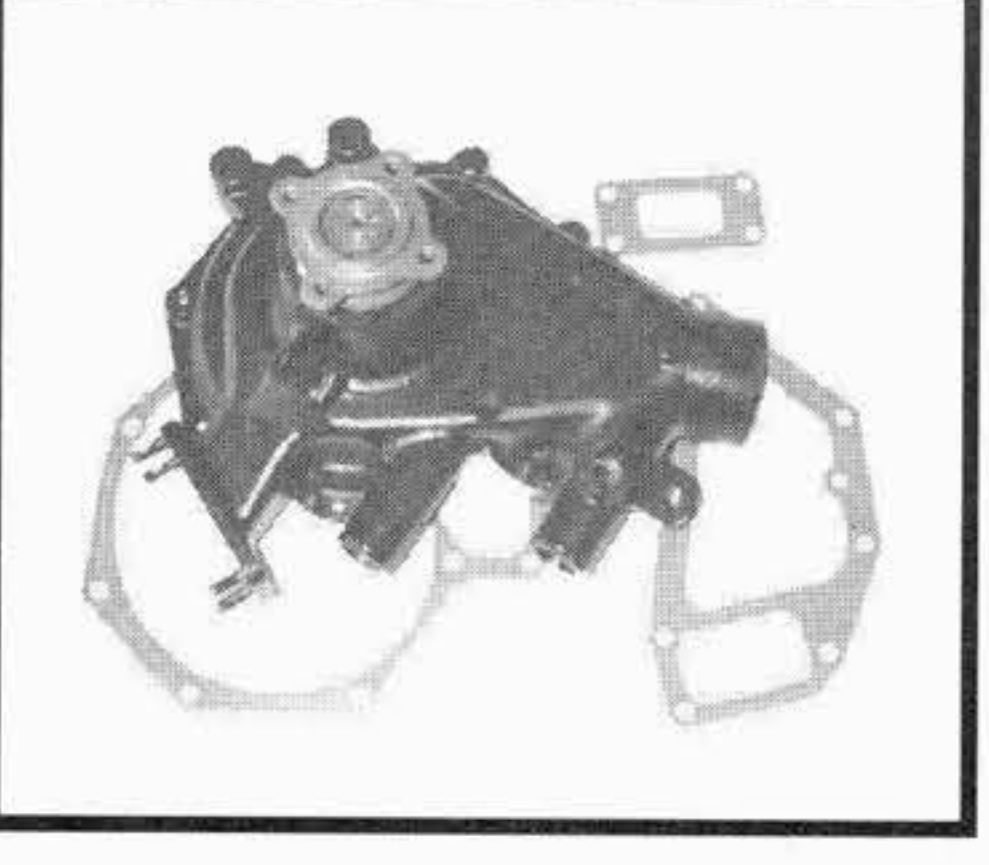
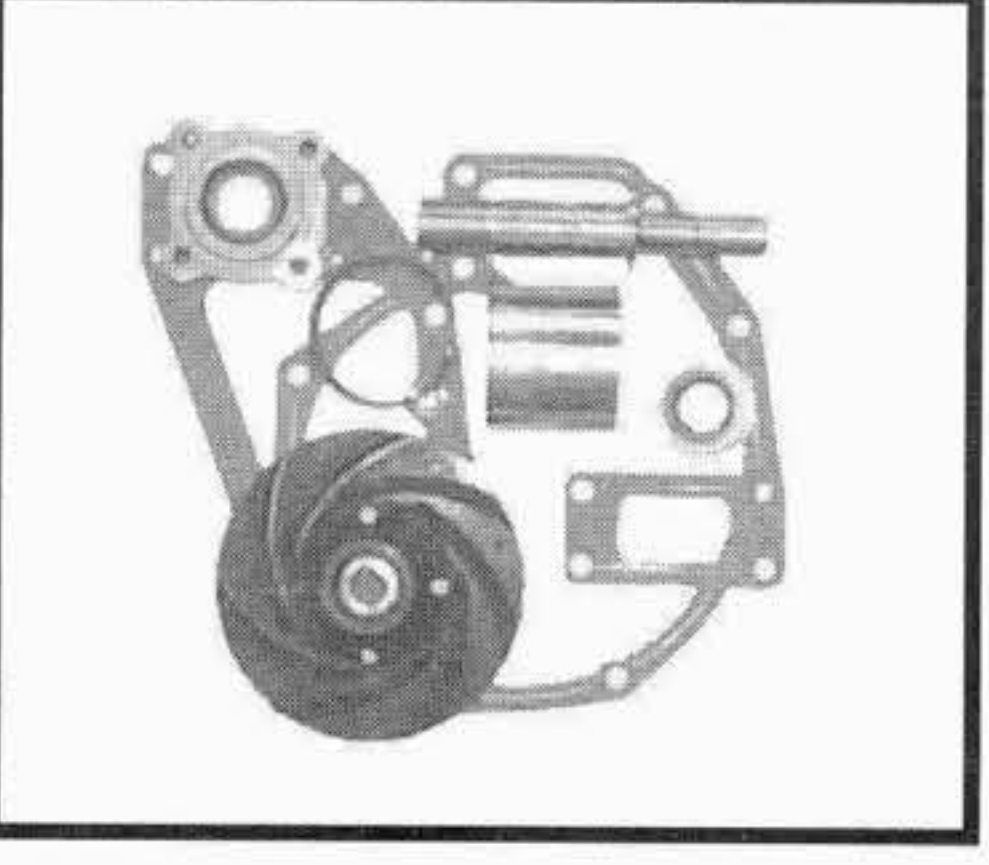
www.spwaterpumps.co.uk

TIPO O MODELLO TYPE OU MODELE TYPE OR MODEL	MOTORE MOTEUR ENGINE	POMPA ACQUA POMPE A EAU WATER PUMP OMP REF. / O.EM. REF	KIT RIPARAZIONE NECESSAIRE DE REP. REPAIR KIT OMP REF. / O.EM. REF
SB220	DKLC 1160 ANTI TURBO INTECOOLING Repair Kit 405.284	405.095  SP1321 0682884	405.098  SP1330 0683404 MILLENIUM VERSION
2800 3300 3600 <i>con elettroventilatore avec ventilateur electric with electric fan</i>	DKS 1160 DKSE 1160 DKST 1160 DKTD 1160	405.075 0682260  VERSIONE RINFORZATA REINFORCED VERSION	405.275 ---  VERSION RENFORCE'
2800 3300 3600 <i>con ventilatore viscostatico avec ventilateur visqueux with viscous - static fan</i>	DKS 1160 DKSE 1160 DKST 1160 DKTD 1160 SB 3000	405.080 0682262  VERSIONE RINFORZATA REINFORCED VERSION	405.276 ---  VERSION RENFORCE'
80 all models tutti i modelli 85 95.330 95.360 95.400 95.430	WS 242 L WS 268 L WS 295 6 cyl. 11,6 L WS 242 L WS 268 L 6 cyl. 11,6 L WS 295 WS 315 G	405.070 0682968  High Flange	405.274 --- 

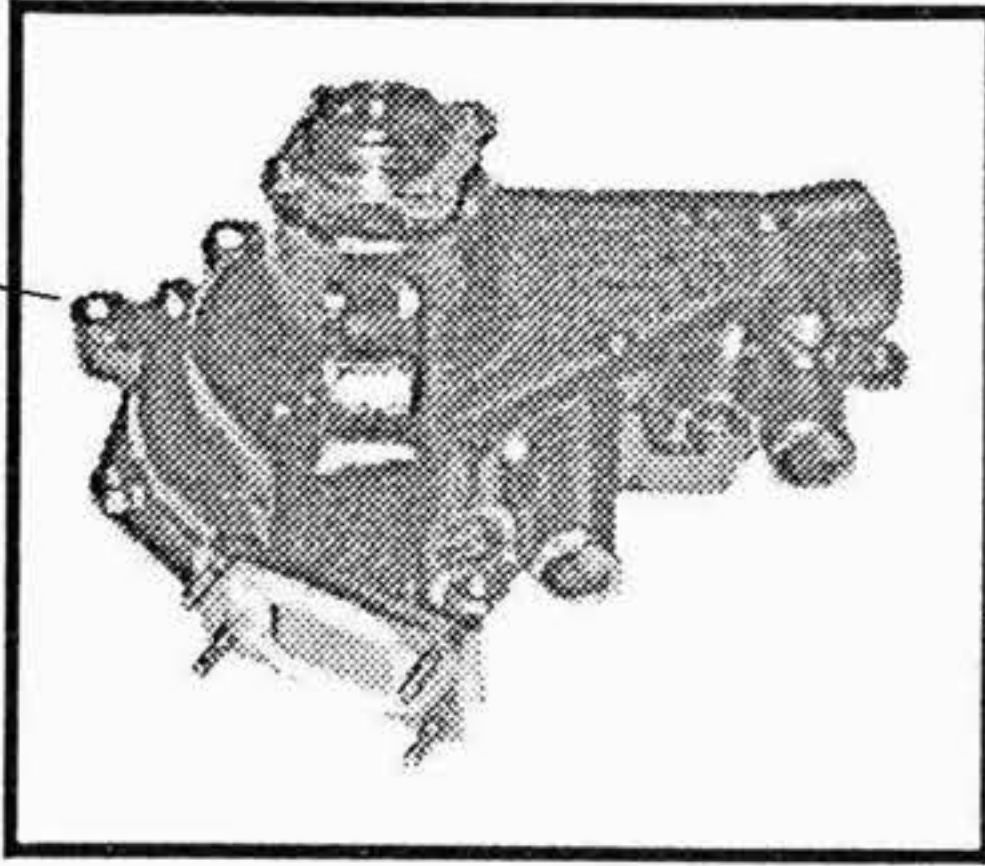
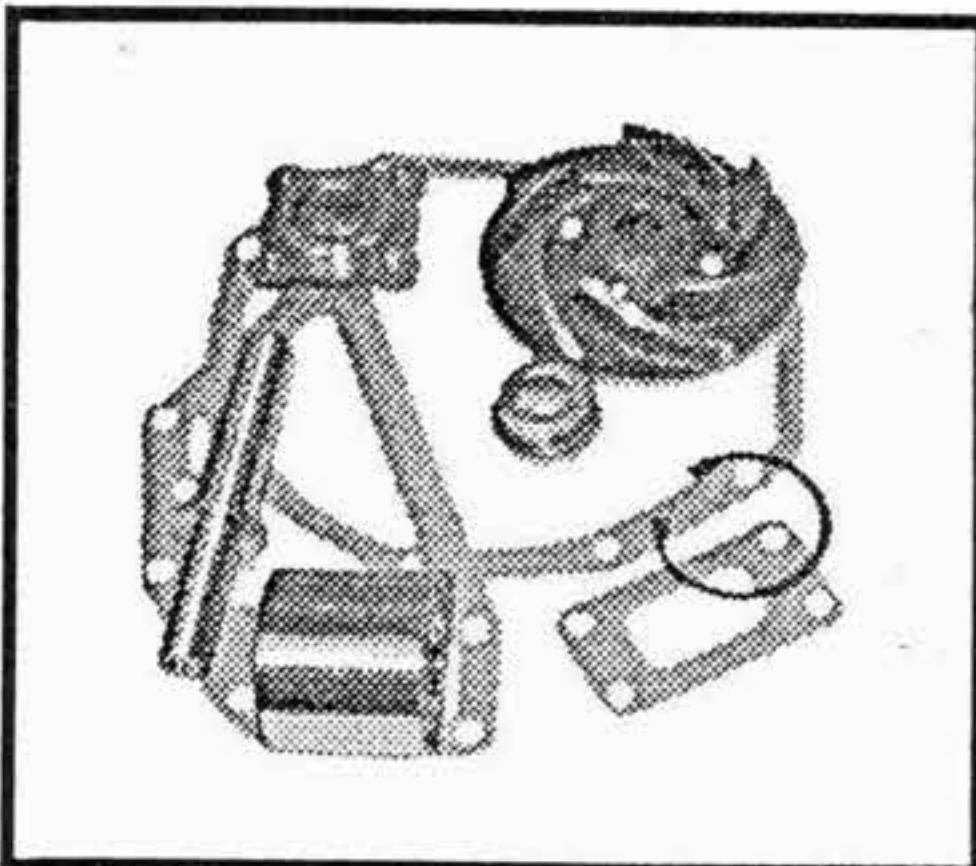
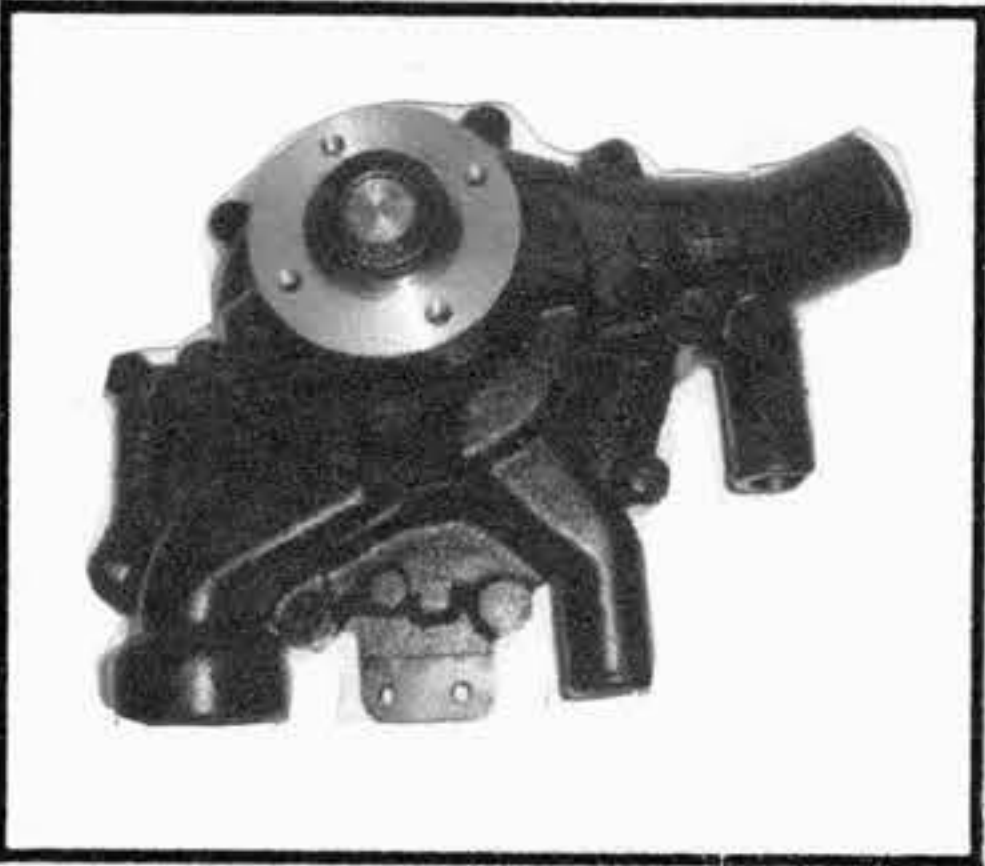
I ricambi non sono originali ma adattabili . Ogni riferimento originale é assolutamente indicativo .
Spare parts are not original but perfectly suitable . Every original part number has to be considered for reference purpose only .

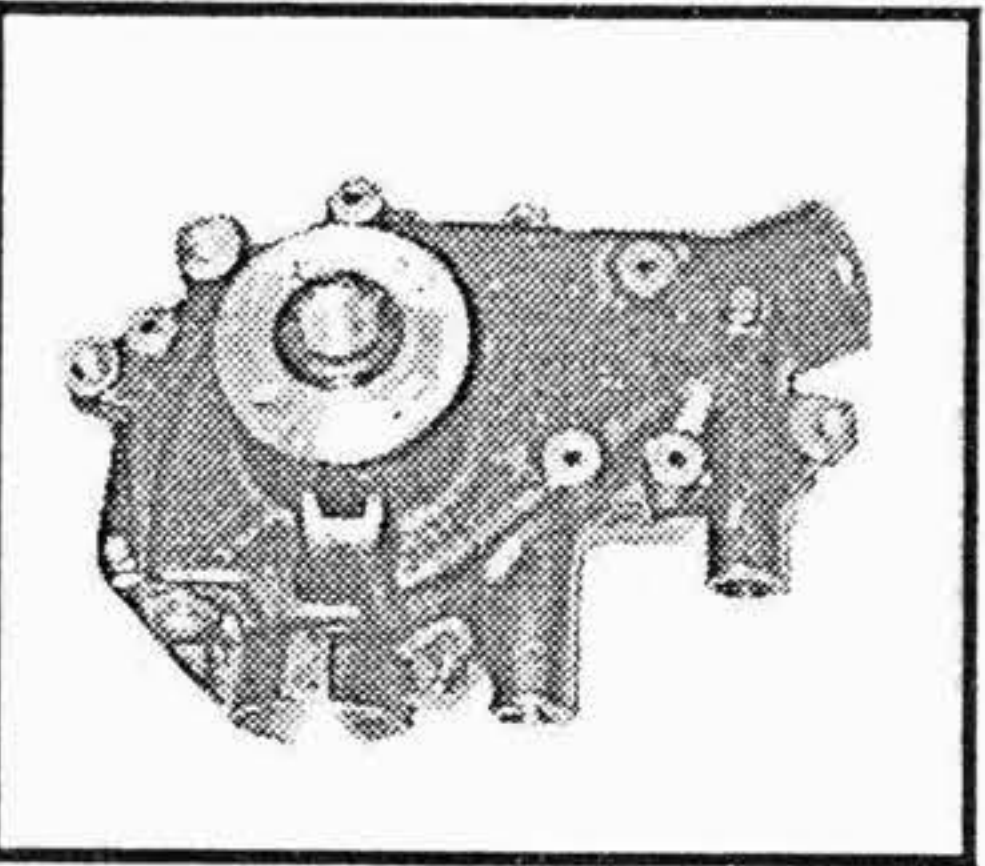
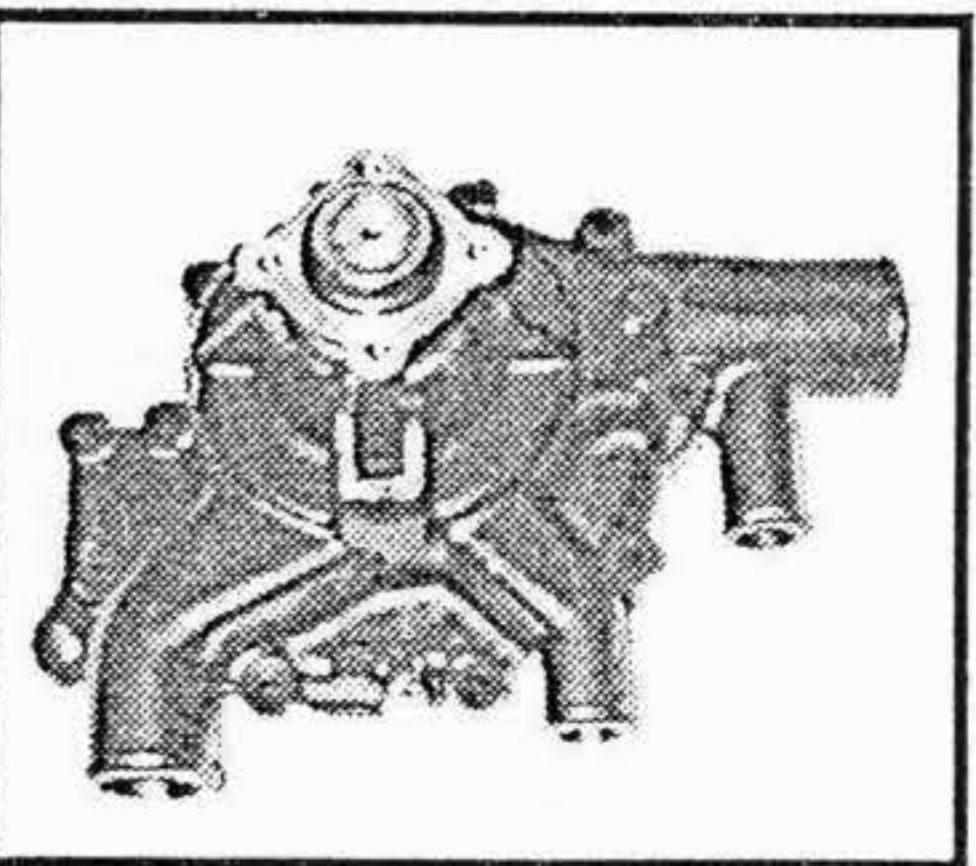
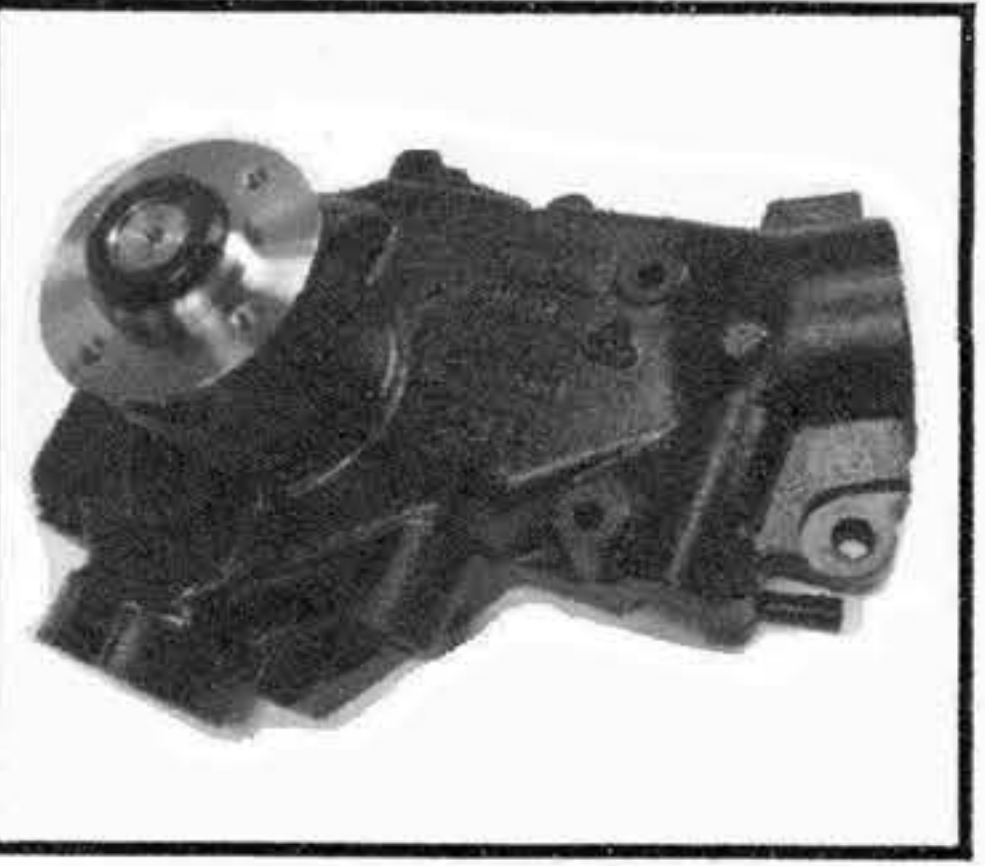
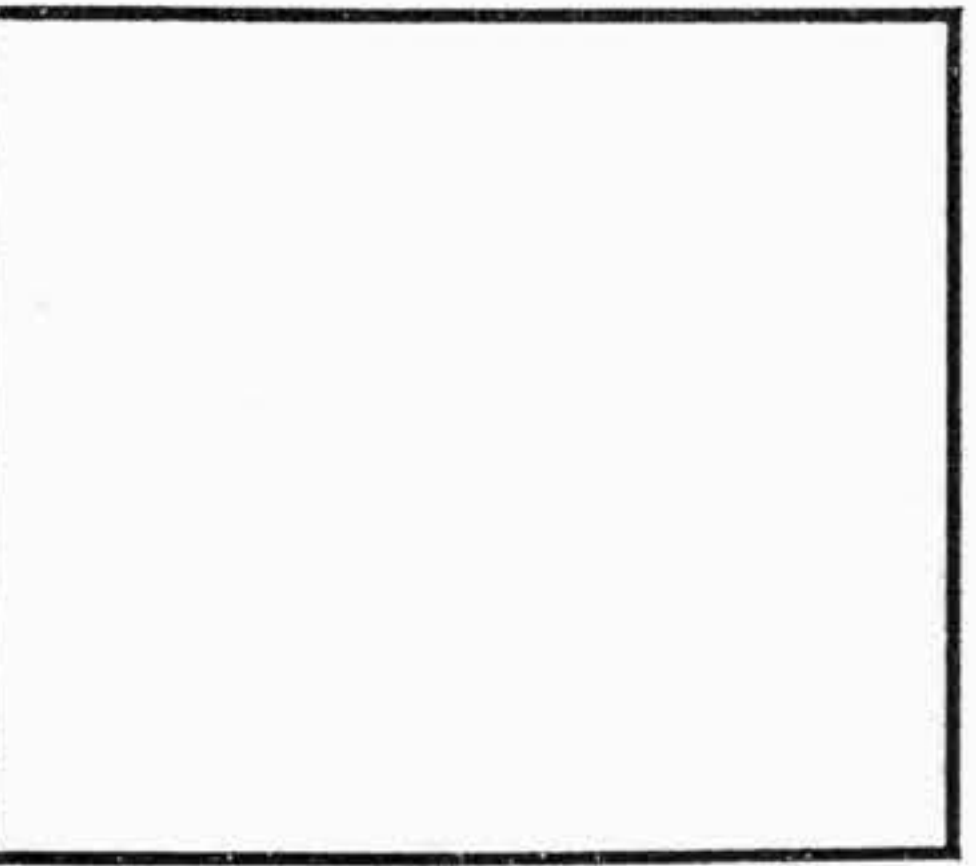
MODEL	ENGINE	WATER PUMP	
80 Srs 85 Srs 95 Srs	WS 315L 6 CYL 11.6 Ltr SB 3000 <i>Alternator Bracket</i>	405.100 - 0682980  85 SRS, 95 SRS	405.285 
75 CF. 405.110 CF 75. 405.120 75 Srs. 405.090 IMPORTANT Please note if the Water Pump is a CF or XF it is important to determine whether the CF or XF comes before or after the number as they are different units	PF 183M PF 212M PF 235M 6 CYL. 9.2 Ltr 1998 On	405.110 0683338  75CF	405.120 0683580  CF75
85 CF 95 XF 0683586 95.430 95.480 IMPORTANT Please note if the Water Pump is a CF or XF it is important to determine whether the CF or XF comes before or after the number as they are different units	6 CYL. 12.6 Ltr XF 250 M XF 280 M XF 315 M CF 280 M CF 315 M	405.105 0683225  85CF, 95XF	405.090 0682747  75 SRS
CF 85 XF 95 IMPORTANT Please note if the Water Pump is a CF or XF it is important to determine whether the CF or XF comes before or after the number as they are different units	CF 85 XF 95	405.115 0683579  CF85, XF95	



SECTION 17

APPLICATION

FORD

INDUSTRIAL ENGINES

WATER PUMPS WASSERPUMPEN
POMPE A EAU BOMBA DE AGUA
POMPA ACQUA

S.P. WATER PUMPS LTD
18 Tatton Court, Kingsland Grange, Woolston,
Warrington, Cheshire. ENGLAND. WAI 4RR
TEL: +44(0) 1925 850082 Fax: +44(0) 1925 850083
Email:sales@spwaterpumps.co.uk Web Site:www.spwaterpumps.co.uk

SUITABLE

FORD

INDUSTRIAL ENGINES

Tel: +44(0)1925 850082 Fax: +44(0)1925 850083

www.spwaterpumps.co.uk



MOTORE
MOTEUR
ENGINE

POMPA ACQUA
POMPE A EAU
WATER PUMP

OMP REF.

O.E.M. REF.

2722

164.145

826F8501ABA

6174469

2725

4 CYL.

2726 T

6 CYL.

2726 TM

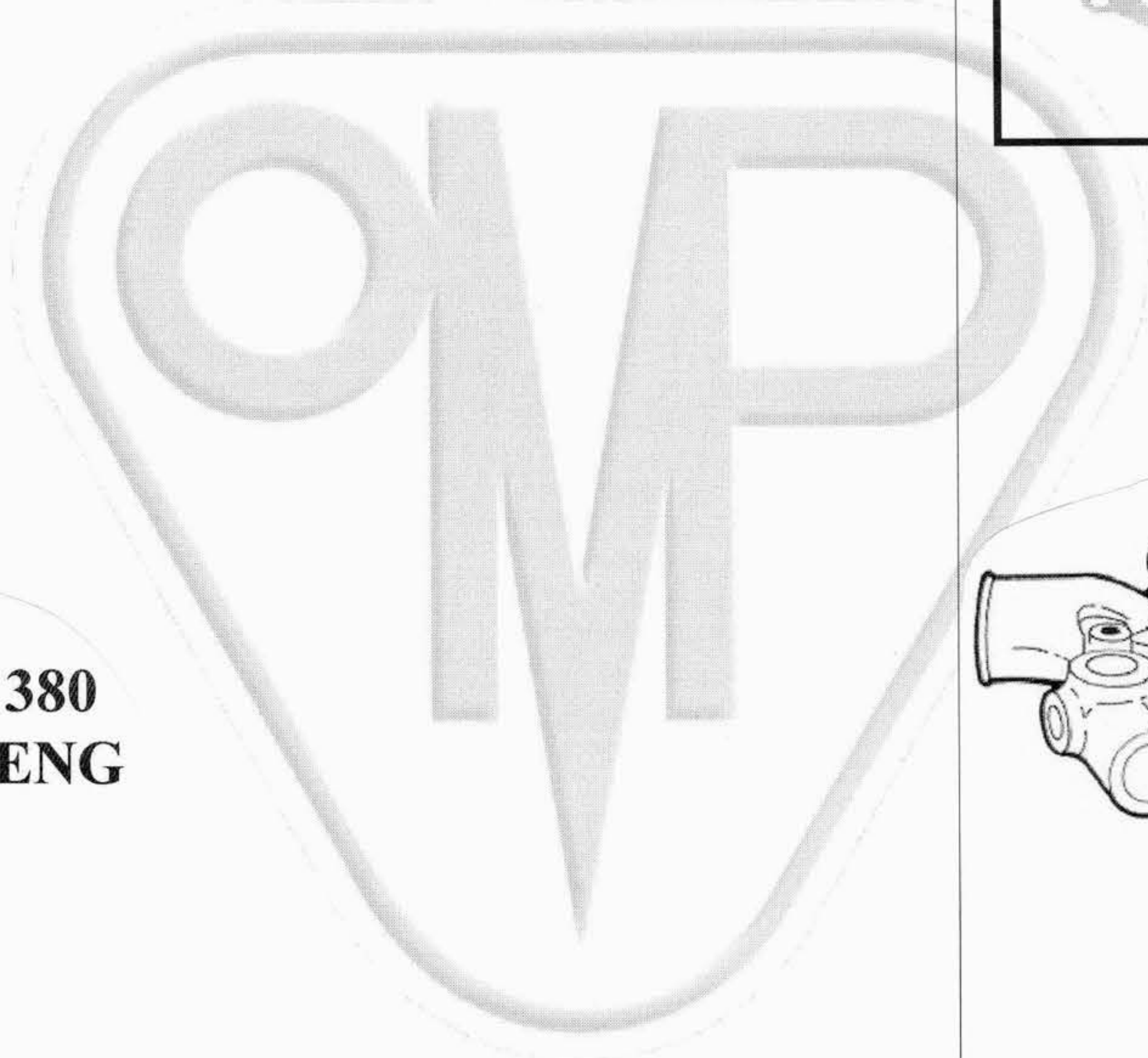
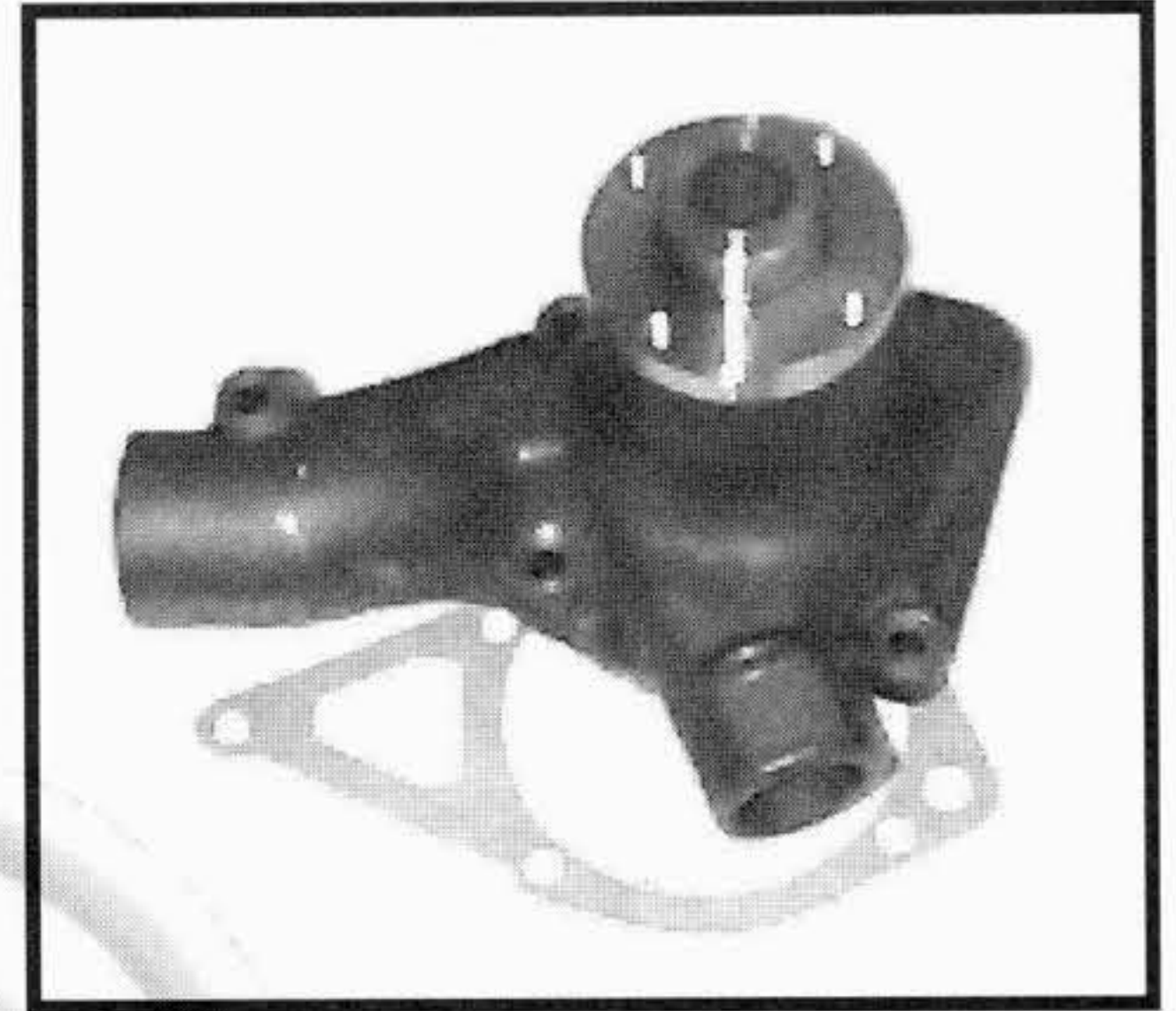

5008468
813, 365, 380
DOVER ENG

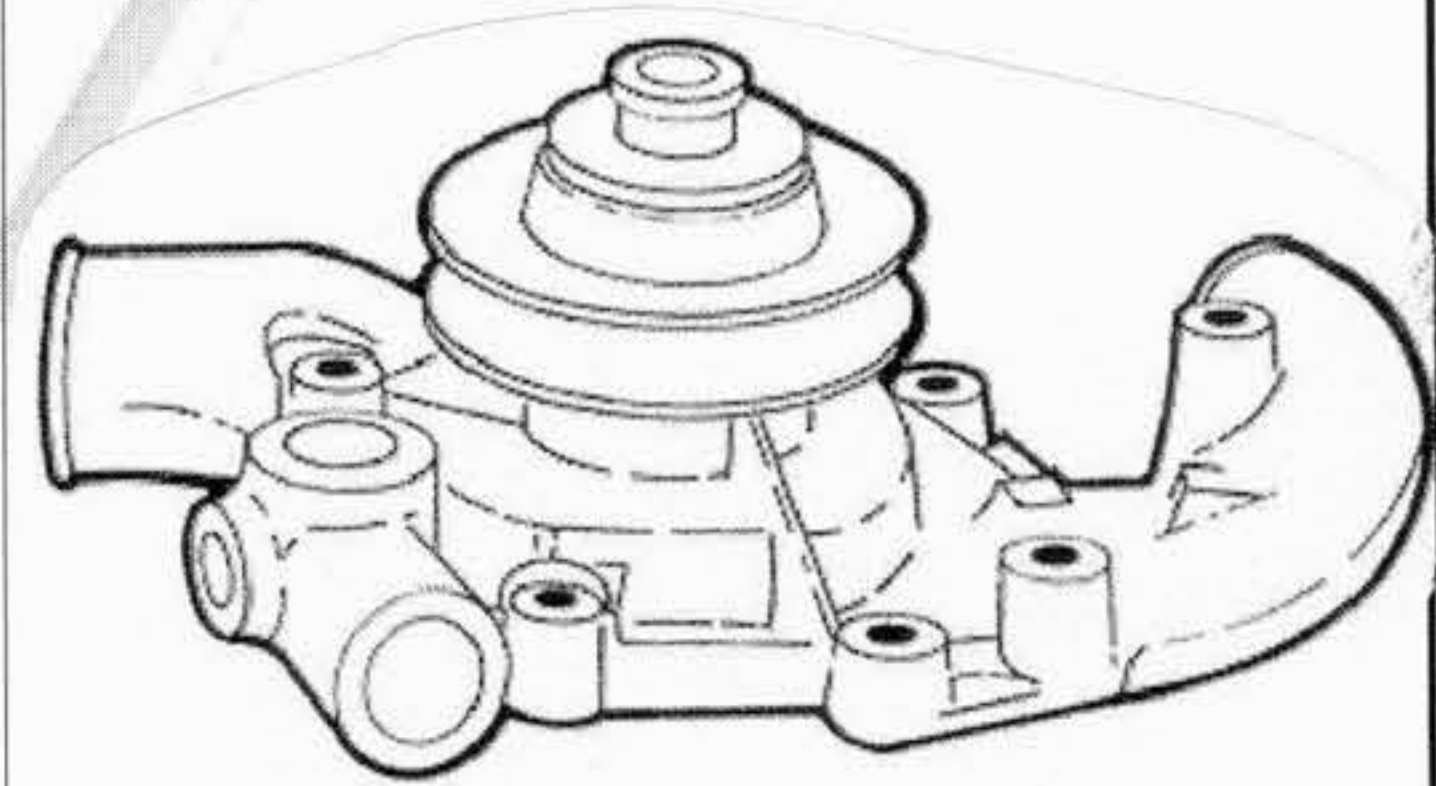

5024545
TRANSIT 2.5

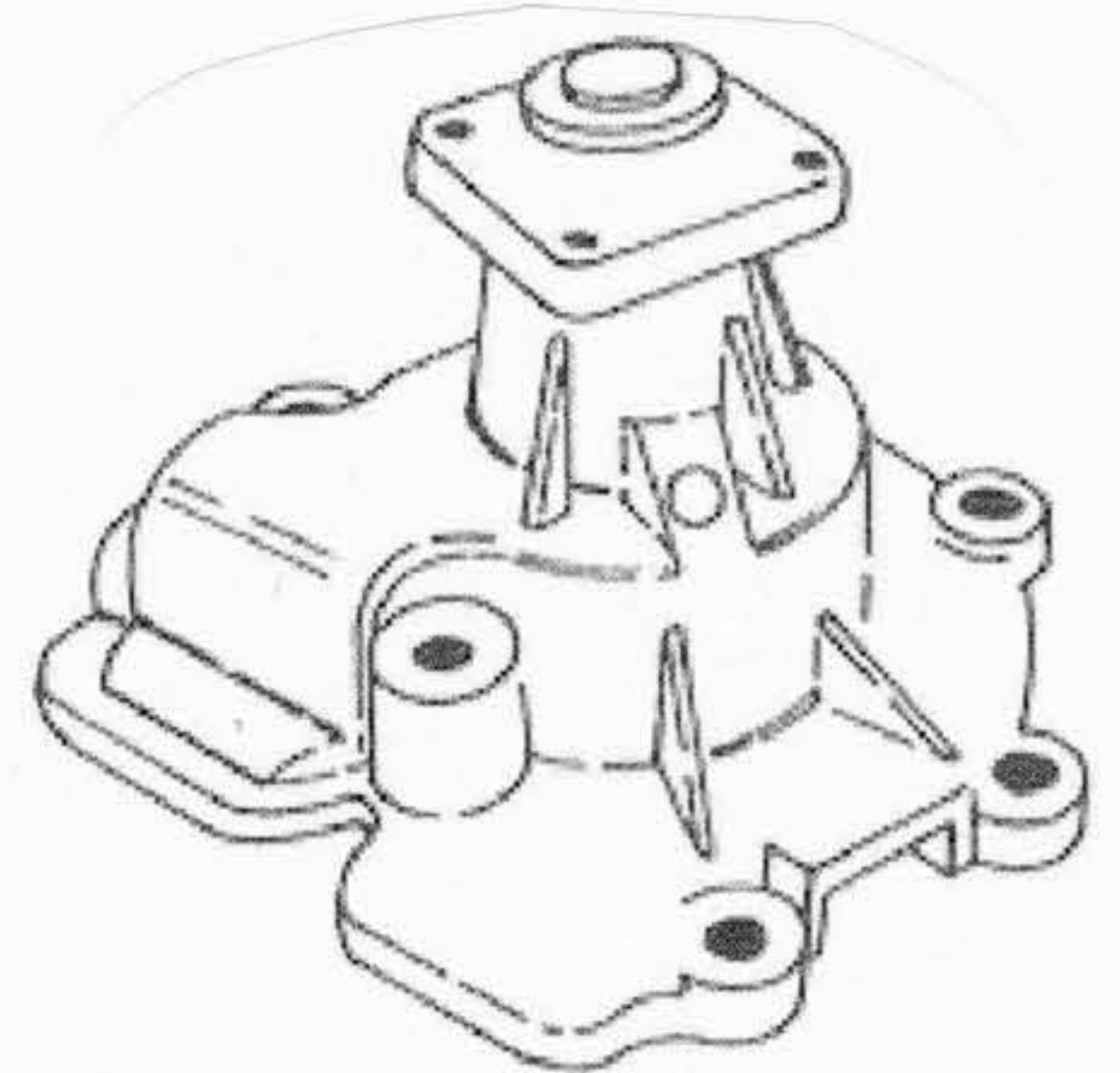



SECTION 20

APPLICATION

GARDNER

ISUZU

**WATER PUMPS WASSERPUMPEN
POMPE A EAU BOMBA DE AGUA
POMPA ACQUA**

S.P. WATER PUMPS LTD
18 Tatton Court, Kingsland Grange, Woolston,
Warrington, Cheshire. ENGLAND. WAI 4RR
TEL: +44(0) 1925 850082 Fax: +44(0) 1925 850083
Email:sales@spwaterpumps.co.uk Web Site:www.spwaterpumps.co.uk

SUITABLE

GARDNER

ENGINES

Tel: +44(0)1925 850082 Fax: +44(0)1925 850083

www.spwaterpumps.co.uk



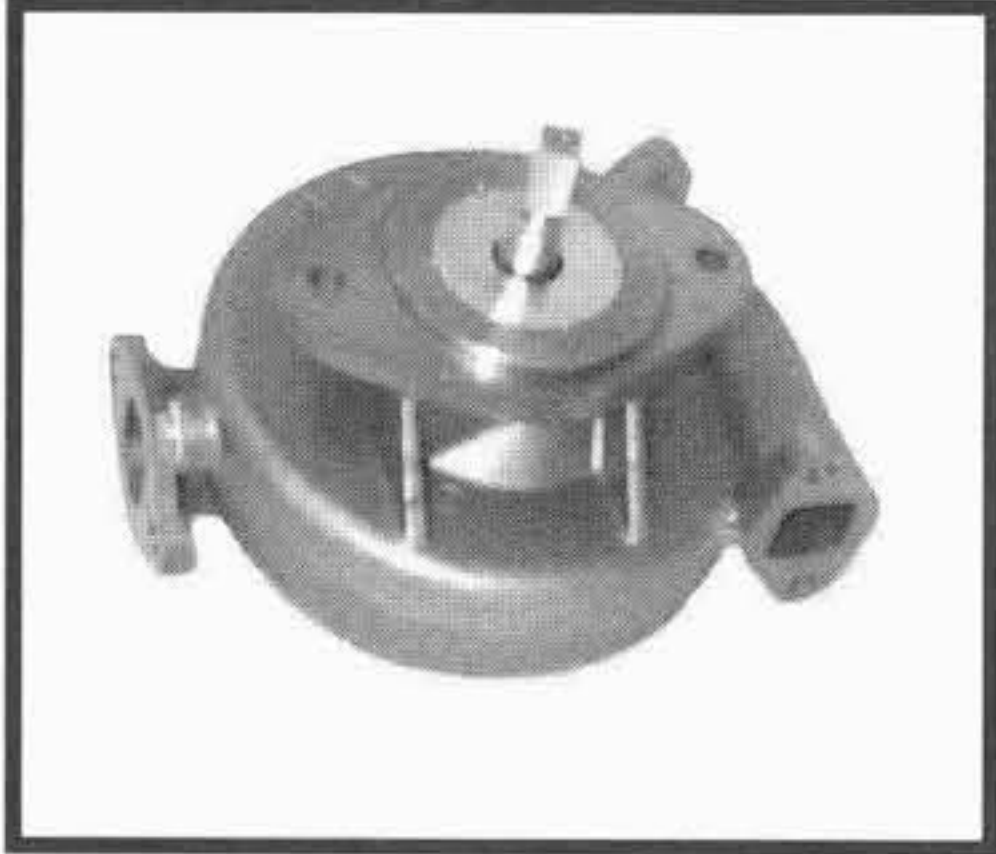
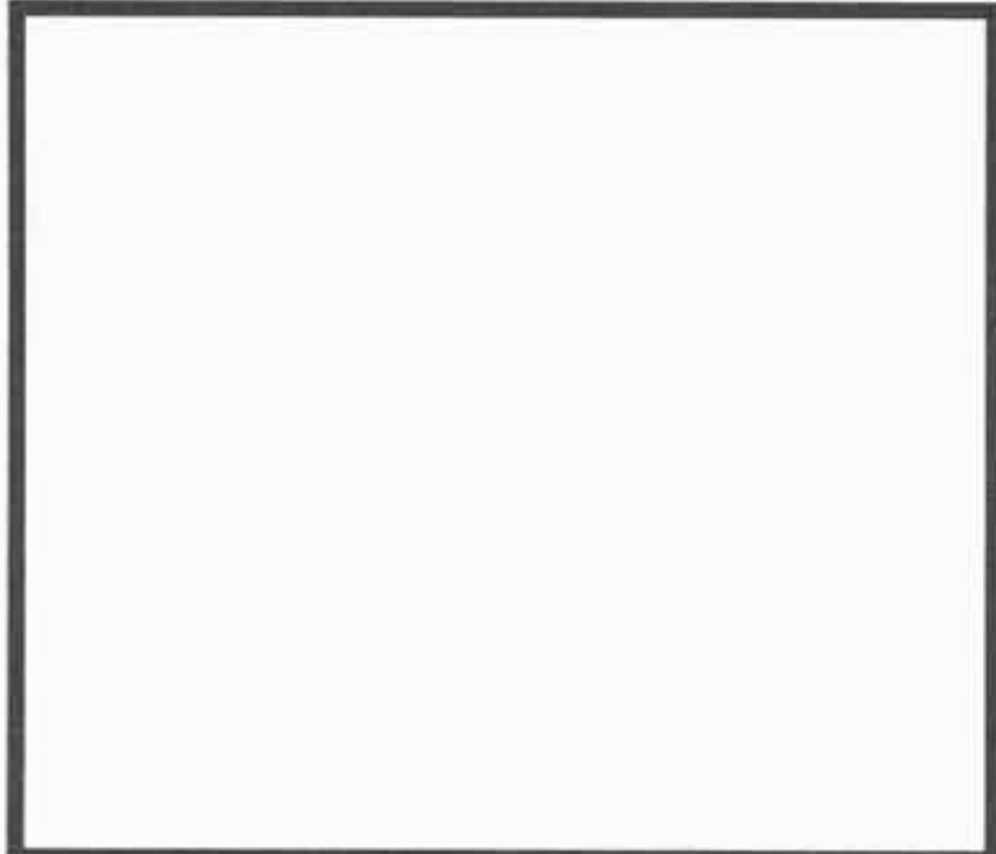

TIPO O MODELLO TYPE OU MODELE TYPE OR MODEL	MOTORE MOTEUR ENGINE	POMPA ACQUA POMPE A EAU WATER PUMP	OMP REF. / O.E.M. REF	KIT RIPARAZIONE NECESSAIRE DE REP. REPAIR KIT	OMP REF. / O.E.M. REF
E.R.F. B Series - M Series FODEN Fleetmaster Haulmaster BRISTOL P.S.V. LEYLAND DAF MCW BUS Tutte le applicazioni con motore All application with engine	LX - LXB LXC - LW XL - XLB MCW XLB - XLC XL - XLB	450.000 TO 2734 		452.252 EO 4435  450.005 AO 4453 albero completo / complete shaft	

SUITABLE

GM-ISUZU

TRUCKS - ENGINES

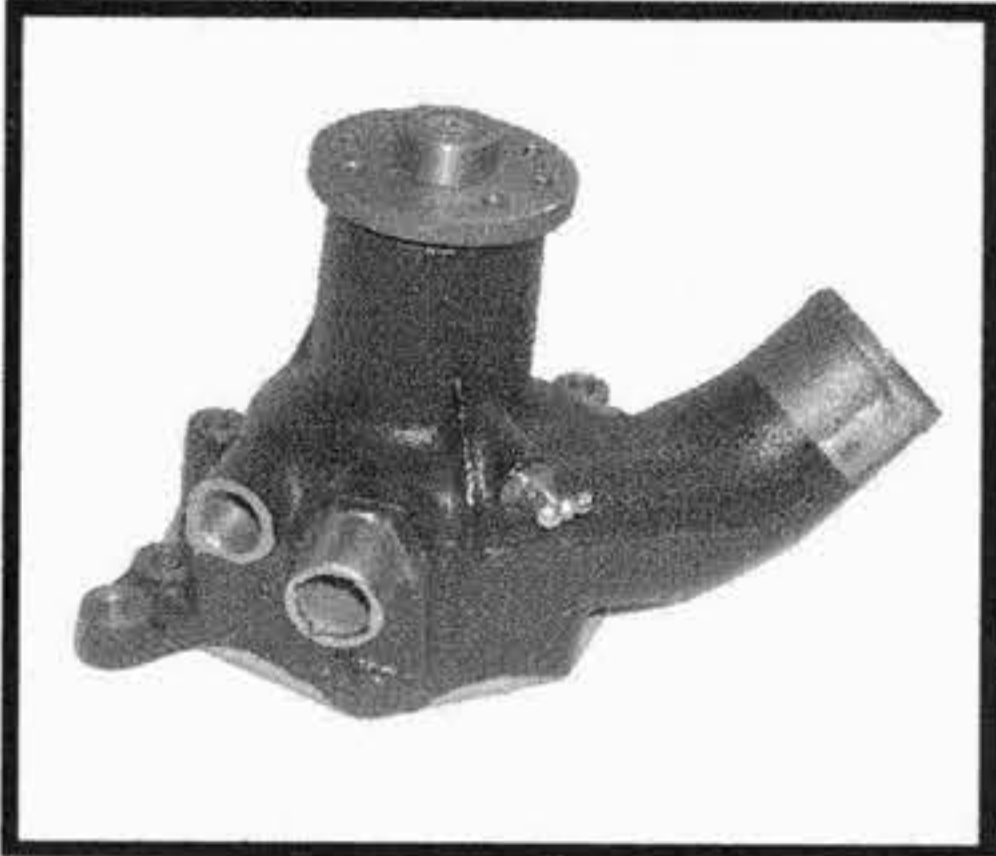
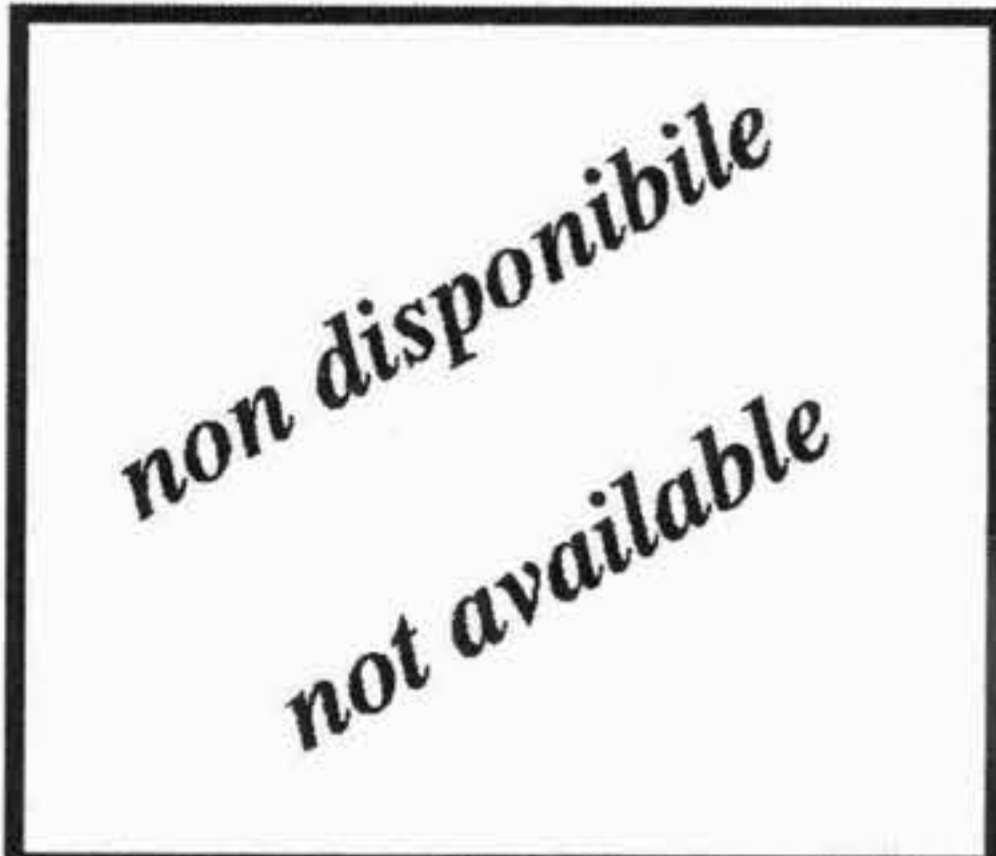

TIPO O MODELLO TYPE OU MODELE TYPE OR MODEL	MOTORE MOTEUR ENGINE	POMPA ACQUA POMPE A EAU WATER PUMP	OMP REF. / O.E.M. REF	KIT RIPARAZIONE NECESSAIRE DE REP. REPAIR KIT	OMP REF. / O.E.M. REF
FORWARD SBR 10/81 ÷ 02/84 322 - 372 - 422 - 452 - 472 - 482 - 522 JBR 10/81 ÷ 06/84 360 - 420 - 500 - 650 SBR 10/81 ÷ 06/84 552 SCR 10/81 ÷ 02/84 320 - 370 - 420 - 450 - 480 - 550 - 650 JCR 10/81 ÷ 06/84 360 - 420 - 460 - 500 - 550 - 650 SCS 10/81 ÷ 06/84 330 - 370 - 420 ESR,FRD,FRR,FSR,FTR-11 02/84 --> FDR 10/81 ÷ 02/84 320 - 370 - 420 - 450 - 480 - 550 - 650 SDR 10/81 ÷ 02/84 320 - 370 - 420 - 450 - 480 - 550 - 650 JDR 10/81 ÷ 02/84 360 - 420 - 460 - 500 - 550 - 650 - VDR320 FRD,FRR,FRS,FSD,FSR,FSS,FTR-12 HTS,HTW,NRR-12 02/84 -->	6 B B 1 6 cyL. 5400 cc Diesel 6 B D 1 6 cyL. 5800 cc Diesel 6 B F 1 6 cyL. 6100 cc Diesel 6 B G 1 6 cyL. 6500 cc Diesel	470.000 1-13610819-0 			
FORK LIFT application Komatsu FD 15 1,5 ton FD 20 2,0 ton --> fino al mot. n° 507061 FD 25 2,5 ton --> fino al mot. n° 507061 FD 30 3,0 ton TCM SD 10 1,0 ton SD 12 1,2 ton FD 20 Z5 2,0 ton FD 25 Z4 2,5 ton FD 30 Z5 3,0 ton	C 240 2400 cc - Diesel --> fino al mot. n° 507061 C 240 2400 cc - Diesel --> fino al mot. n° 555072	470.011 5-13610057-0 			

I ricambi non sono originali ma adattabili . Ogni riferimento originale é assolutamente indicativo .
Spare parts are not original but perfectly suitable . Every original part number has to be considered for reference purpose only .



SECTION 23

APPLICATION

IVECO

WATER PUMPS WASSERPUMPEN
POMPE A EAU BOMBA DE AGUA
POMPA ACQUA

S.P. WATER PUMPS LTD
18 Tatton Court, Kingsland Grange, Woolston,
Warrington, Cheshire. ENGLAND. WAI 4RR
TEL: +44(0) 1925 850082 Fax: +44(0) 1925 850083
Email:sales@spwaterpumps.co.uk Web Site:www.spwaterpumps.co.uk

TAVOLE DI CONVERSIONE
TABLE DE CONVERSION
CONVERSION TABLE

IVECO (FIAT - OM - UNIC



NUMERO ORIGINALE NUMERO ORIGINAL ORIGINAL NUMBER	NUMERO SOSTITUTIVO REPLACE PAR NUMERO REPLACED BY NUMBER	RIFERIMENTO OMP REFERENCE OMP OMP REFERENCE
540454		211.462
540456		211.461
540461		211.467
543747		198.027
549421		198.001
550734		198.028
552113		211.445
552159		211.442
552161		211.454
552162		211.459
552163		211.452
552164		211.447
552165		211.446
552170		211.466
552406		196.012
552407		196.001
554148		198.037
554564	GHISA	191.159
554564	ALLUMINIO	191.170
554571		191.164
554576		
559213		191.266
560945		191.334
560949		191.188
561896	4621723	
562988	GHISA	191.155
562988	ALLUMINIO	191.156
562993		191.162
564051		196.322
564077		191.329
564078		191.332
565077		198.011
565975		ESAURITO
568446		191.322
568447		261.705
568685		261.708
569659		198.012
570636		ESAURITO
570930		191.325
570948		ESAURITO
571518		191.320
572114		ESAURITO
572196		ESAURITO
572725		ESAURITO
574352		198.057
574545		198.063
574714		198.056

NUMERO ORIGINALE NUMERO ORIGINAL ORIGINAL NUMBER	NUMERO SOSTITUTIVO REPLACE PAR NUMERO REPLACED BY NUMBER	RIFERIMENTO OMP REFERENCE OMP OMP REFERENCE
574965		198.061
581678		ESAURITO
589634		191.624
594656		198.097
596443		ESAURITO
598378		198.030
604589		191.351
742091		191.276
742878		191.274
742886		191.273
743710		198.053
755002		196.005
755004		196.011
755006		198.275
758842		196.004
759678		198.067
759699		191.262
759700		191.356
759740		261.358
759741		ESAURITO
759742		261.359
761267		198.324
761311		196.060
761312		196.030
761371		196.155
761409		196.156
761471		198.081
761476		ESAURITO
761993		196.008
761994		196.009
761995		196.031
762083		196.038
813579		191.168
840973		198.058
841062		191.195
841767		191.027
844379		191.196
849187		198.059
852185		198.069
859814		198.060
882723		191.405
885061		196.006
885062	ALLUMINIO	191.622
885062	GHISA	191.344
885068		191.627
888754		ESAURITO
894929		191.342

OGNI RIFERIMENTO ORIGINALE E' ASSOLUTAMENTE INDICATIVO. CHAQUE REFERENCE ORIGINAL EST ABSOLUMENT INDICATIVE. EVERY ORIGINAL PART NUMBER HAS TO BE CONSIDERED FOR REFERENCE PURPOSE ONLY.

TAVOLE DI CONVERSIONE
TABLE DE CONVERSION
CONVERSION TABLE

IVECO



NUMERO ORIGINALE NUMERO ORIGINAL ORIGINAL NUMBER	NUMERO SOSTITUTIVO REPLACE PAR NUMERO REPLACED BY NUMBER	RIFERIMENTO OMP REFERENCE OMP OMP REFERENCE
967564		ESAURO
969759		191.336
969760		191.341
969761		191.534
975806		268.228
975893		ESAURO
977118		198.039
977122		198.052
977150		198.072
996342	ALLUMINIO	191.618
996342	GHISA	ESAURO
999285	ALLUMINIO	ESAURO
999285	GHISA	191.160
1902653		192.239
1902654		192.234
1902655		192.019
1902656		192.139
1902659		192.013
1902660		262.081
1902661		262.082
1904768		192.251
1940105		222.264
4025548		191.173
4025776		191.193
4028505		198.043
4034694		268.193
4044726		191.176
4044736		191.177
4081489		
4138766		191.007
4159041		191.202
4159382		191.209
4159383		191.211
4159384		191.215
4159392		198.121
4171520	11060275	
4181901		191.199
4181902		191.204
4206723		198.124
4242132		191.815
4267566		191.151
4279502		191.101
4279512	4764763	
4512049		198.104
4515966		ESAURO
4534238	ALLUMINIO	191.623
4534238	GHISA	ESAURO

NUMERO ORIGINALE NUMERO ORIGINAL ORIGINAL NUMBER	NUMERO SOSTITUTIVO REPLACE PAR NUMERO REPLACE BY NUMBER	RIFERIMENTO OMP REFERENCE OMP OMP REFERENCE
4537923		261.637
4537924		261.644
4537925		198.299
4537930		261.647
4537931		261.282
4537932		261.651
4537933		
4538058	ALLUMINIO	191.619
4538058	GHISA	ESAURO
4538433		ESAURO
4539422		ESAURO
4540232		ESAURO
4543905		ESAURO
4544917	4622600	
4544918		196.321
4544922		191.326
4545544		191.343
4546648		198.119
4546980	ALLUMINIO	191.621
4546980	GHISA	ESAURO
4547426		198.170
4547441		198.091
4547452		191.293
4547543		191.279
4547634		191.287
4547637		191.292
4548014		ESAURO
4548623		198.110
4548625		198.136
4548871		198.180
4549310		ESAURO
4549443		198.128
4550925		198.089
4551507		191.194
4551508		191.178
4557736		
4567176		198.129
4567238		ESAURO
4569184		191.179
4570275		ESAURO
4570278		ESAURO
4570285		ESAURO
4572928		198.016
4572935		198.015
4575284		198.010
4580034		ESAURO
4580036		ESAURO

OGNI RIFERIMENTO ORIGINALE E' ASSOLUTAMENTE INDICATIVO. CHAQUE REFERENCE ORIGINAL EST ABSOLUMENT INDICATIVE. EVERY ORIGINAL PART NUMBER HAS TO BE CONSIDERED FOR REFERENCE PURPOSE ONLY.

TAVOLE DI CONVERSIONE
TABLE DE CONVERSION
CONVERSION TABLE

IVECO (FIAT - OM - UNIC



NUMERO ORIGINALE NUMERO ORIGINAL ORIGINAL NUMBER	NUMERO SOSTITUTIVO REPLACE PAR NUMERO REPLACED BY NUMBER	RIFERIMENTO OMP REFERENCE OMP OMP REFERENCE
4580678		198.125
4580683		268.138
4583899		191.335
4583900		191.324
4585212		191.323
4585783		261.634
4585990		191.077
4585990	4587258	
4587048		191.192
4587050		191.186
4587258		191.183
4591436		191.283
4591437		191.290
4592557		191.278
4593234		191.189
4593329		198.014
4596277		191.180
4598654		198.137
4599557		191.237
4599560		191.241
4600130		208.018
4600187		198.049
4600926		191.228
4601574		ESAUrito
4601647		268.036
4601884		777.730
4601938		191.248
4602323		198.050
4602502		191.285
4602503		191.190
4603870		191.207
4603871		191.231
4604079		261.641
4604114		261.640
4604250		268.040
4606023		191.300
4606027		191.301
4606028		191.304
4606030		191.298
4606031	4757006	
4606033		191.299
4606034		191.303
4606042		191.309
4606046		191.311
4606050		198.225
4606051		191.297
4606094		191.308

NUMERO ORIGINALE NUMERO ORIGINAL ORIGINAL NUMBER	NUMERO SOSTITUTIVO REPLACE PAR NUMERO REPLACED BY NUMBER	RIFERIMENTO OMP REFERENCE OMP OMP REFERENCE
4606668		ESAUrito
4606783		228.166
4606784		ESAUrito
4606786		198.163
4609390		198.107
4610728		198.112
4610729		198.113
4612658		191.319
4613393	4613395	
4613395		191.280
4613684		ESAUrito
4615454		198.130
4616630		191.249
4617099		201.982
4617974		198.126
4618791		261.663
4619014		268.239
4619015		ESAUrito
4619047		268.005
4619049		261.681
4619192		261.664
4619193		261.676
4619249		261.674
4619257	4757008	
4619285		198.076
4619438		198.141
4619685		ESAUrito
4621723		191.321
4622324		198.176
4622600		ESAUrito
4622603		ESAUrito
4622957		198.114
4623920		ESAUrito
4623950		198.108
4627792		198.162
4628067		198.139
4628338		198.169
4628683		198.046
4629312		268.068
4629318		268.070
4629855		198.105
4636994		261.360
4637993		ESAUrito
4639095		191.257
4639096		191.138
4639097		191.239
4639182	4679242	

OGNI RIFERIMENTO ORIGINALE E' ASSOLUTAMENTE INDICATIVO. CHAQUE REFERENCE ORIGINAL EST ABSOLUMENT INDICATIVE. EVERY ORIGINAL PART NUMBER HAS TO BE CONSIDERED FOR REFERENCE PURPOSE ONLY.

TAVOLE DI CONVERSIONE
TABLE DE CONVERSION
CONVERSION TABLE

IVECO



NUMERO ORIGINALE NUMERO ORIGINAL ORIGINAL NUMBER	NUMERO SOSTITUTIVO REPLACE PAR NUMERO REPLACED BY NUMBER	RIFERIMENTO OMP REFERENCE OMP OMP REFERENCE
4639593		208.221
4640591		198.106
4641315		ESAUrito
4642042		191.142
4643221		261.658
4645817		ESAUrito
4646089		261.655
4649580		198.122
4651309		198.109
4651453		198.132
4652683		198.181
4654154		191.247
4654782		261.661
4654783		261.662
4654784		261.659
4654785		261.616
4654786		261.671
4654787		268.323
4654872		191.200
4654874		191.210
4655011		191.260
4655013		198.177
4655015		208.140
4655354		268.064
4655822		ESAUrito
4655865		198.131
4655871		ESAUrito
4655933		191.258
4655935		198.013
4658336		ESAUrito
4658400		191.294
4658663		777.730
4665568		261.357
4665569		261.361
4665576		261.650
4666429		198.048
4666584		ESAUrito
4669107		188.233
4669736		ESAUrito
4669737		198.226
4671954		191.382
4672084		191.901
4672087		191.377
4673810		191.078
4677587		191.385
4679242	93191101	
4979303	4679242	

NUMERO ORIGINALE NUMERO ORIGINAL ORIGINAL NUMBER	NUMERO SOSTITUTIVO REPLACE PAR NUMERO REPLACED BY NUMBER	RIFERIMENTO OMP REFERENCE OMP OMP REFERENCE
4679304		ESAUrito
4679387	9842018	
4679559	93191103	
4679560	93191103	
4684447		198.164
4684786		191.372
4687219		191.313
4687221		191.314
4687222		
4692494		191.099
4693901		198.183
4695786	4737154	
4696584		198.182
4696586		198.168
4702369		ESAUrito
4702377		ESAUrito
4704103		191.104
4704872		268.083
4706369		268.090
4706878	4764158	
4706879	4752545	
4706880	4752546	
4709607		191.632
4710552		191.310
4710554		191.119
4710555		191.115
4710556		191.120
4711702		191.686
4711703		191.668
4711704		191.667
4711705		191.684
4711706	4796535	
4711933		198.073
4711936		198.075
4712083		191.924
4713189		191.633
4713634	4796527	
4713941		198.235
4713945		191.107
4714636	4754850	
4714637	7302343	
4717918		198.339
4719580		268.191
4720031	4755003	
4720686		191.904
4721386		198.245
4721388		198.246

OGNI RIFERIMENTO ORIGINALE E' ASSOLUTAMENTE INDICATIVO. CHAQUE REFERENCE ORIGINAL EST ABSOLUMENT INDICATIVE. EVERY ORIGINAL PART NUMBER HAS TO BE CONSIDERED FOR REFERENCE PURPOSE ONLY.

TABLE DE CONVERSION
CONVERSION TABLE

IVECO (FIAT - OM - UNIC)



NUMERO ORIGINALE NUMERO ORIGINAL ORIGINAL NUMBER	NUMERO SOSTITUTIVO REPLACE PAR NUMERO REPLACED BY NUMBER	RIFERIMENTO OMP REFERENCE OMP OMP REFERENCE
4723063		196.327
4726860		201.921
4726861		201.919
4731643		201.922
4732109		201.938
4732563		196.370
4732568		228.290
4736987		208.095
4737154	4764156	
4737155		191.903
4737157		198.250
4737160		191.905
4737161		198.252
4746402	4796537	
4747095		198.294
4749418	93191102	
4751406		196.193
4752137		196.070
4752545		191.669
4752546		191.682
4754850	4764761	
4754852		196.037
4755003	4764782	
4757006		191.302
4757008		191.295
4760948	93191104	
4760949		198.333
4761463		196.065
4761464		196.066
4764090		196.014
4761615		206.010
4764156		196.015
4764157		196.016
4764158		196.017
4764761	7303009	
4764763		193.032
4764764		196.033
4764782	7302358	
4770614	4813442	
4772843		191.386
4773219	4777806	
4773220		196.061
4773221		196.017
4777222		191.020
4777805		196.143
4777806	4813730	
4782282		196.071

NUMERO ORIGINALE NUMERO ORIGINAL ORIGINAL NUMBER	NUMERO SOSTITUTIVO REPLACE PAR NUMERO REPLACED BY NUMBER	RIFERIMENTO OMP REFERENCE OMP OMP REFERENCE
4784078	4829218	
4784105		196.146
4784454	4813370	
4786730	4813730	
4787092	4808080	
4796527		196.170
4796535		196.175
4796536		216.635
4796537		206.200
4800483	4813730	
4800484		196.151
4808080		196.148
4808471	98468830	
4808472		196.199
4812406	500300470	
4813370		206.265
4813442		206.068
4813730	4835043	
4823810		196.420
4835043	98497115	
4829218		206.077
4838676		196.445
4872058		261.657
4872061		261.645
4872141		261.642
4919108		216.130
4951264		ESAURITO
4951280		198.041
5414635		191.216
5416786		ESAURITO
5446164		191.218
7300031		
7300871		196.147
7301593	7302443	
7302008		196.191
7302343		196.062
7302358	7303050	
7302443	7303030	
7302476	7303056	
7302756		196.183
7302776	98421056	
7303009	99440726	
7303010		196.192
7303029	7303050	
7303030		196.185
7303050	98418986	
7303056		196.190

OGNI RIFERIMENTO ORIGINALE E' ASSOLUTAMENTE INDICATIVO. CHAQUE REFERENCE ORIGINAL EST ABSOLUMENT INDICATIVE. EVERY ORIGINAL PART NUMBER HAS TO BE CONSIDERED FOR REFERENCE PURPOSE ONLY.

TAVOLE DI CONVERSIONE
TABLE DE CONVERSION
CONVERSION TABLE

IVECO



NUMERO ORIGINALE NUMERO ORIGINAL ORIGINAL NUMBER	NUMERO SOSTITUTIVO REPLACE PAR NUMERO REPLACED BY NUMBER	RIFERIMENTO OMP REFERENCE OMP OMP REFERENCE
8017541		196.384
8100569		198.300
8100731		206.020
8107660		206.205
8109614		196.395
8502967		198.025
8513753		211.443
8514011		196.025
8807763		211.460
8807764		211.458
8807765		211.456
8810326		211.463
8812390		211.455
8813011		191.407
8813126		211.444
8813157		191.406
8813221		201.983
8813247		211.465
8814938		191.414
8814939		191.412
8814940		191.415
8815771		ESAU RITO
8815776		191.206
8816033		218.115
8816036		191.403
8817730		191.401
8818227		211.489
8818228		211.487
8818239		211.488
8819120		198.074
8820045		198.096
8820133		211.518
8820138		211.517
8820503		261.646
8821060		211.514
8821153	8821761	
8821429		211.504
8821430		211.506
8821436		211.526
821438		211.528
8821439		211.527
8821526		198.118
8821638		191.413
8821761	191.404	
8822216		ESAU RITO
8822833		211.529
8822950		211.523

NUMERO ORIGINALE NUMERO ORIGINAL ORIGINAL NUMBER	NUMERO SOSTITUTIVO REPLACE PAR NUMERO REPLACED BY NUMBER	RIFERIMENTO OMP REFERENCE OMP OMP REFERENCE
8822971	8826871	
8823324		196.076
8823331	Ghisa	ESAU RITO
8823331	Alluminio	196.056
8823610		218.144
8823963		198.116
8825427		ESAU RITO
8826061		196.093
8826062		196.091
8826073		191.599
8826147		196.092
8826870		ESAU RITO
8826871		218.355
8826872		211.993
8826873		211.994
8827712		198.154
8828555		191.991
8828627		191.507
8829047		211.375
8829116		191.996
8829125		191.417
8829126		191.418
8829127		191.402
8829148		191.409
8829154		196.075
8829182		191.492
8829183		191.476
8829184		211.521
8829185		211.519
8829329		191.498
8829330		211.499
8829331		211.501
8829769		191.990
8829770		191.995
8829777		191.410
8829779		211.520
8829787		221.485
8829792		191.464
8829831		196.135
8829832		196.055
8829833		196.090
9842018		196.324
10012490		211.448
10014290		196.003
10014690		196.013
10015390		261.353
10016290		261.638

OGNI RIFERIMENTO ORIGINALE E' ASSOLUTAMENTE INDICATIVO. CHAQUE REFERENCE ORIGINAL EST ABSOLUMENT INDICATIVE. EVERY ORIGINAL PART NUMBER HAS TO BE CONSIDERED FOR REFERENCE PURPOSE ONLY.

TAVOLE DI CONVERSIONE
TABLE DE CONVERSION
CONVERSION TABLE

IVECO (FIAT - OM - UNIC



NUMERO ORIGINALE NUMERO ORIGINAL ORIGINAL NUMBER	NUMERO SOSTITUTIVO REPLACE PAR NUMERO REPLACED BY NUMBER	RIFERIMENTO OMP REFERENCE OMP OMP REFERENCE
10205720		191.167
10205820		191.191
10205920		191.281
10257060		191.533
10282460		191.384
10296160		261.652
10300571		261.709
10300611		191.383
10300771		191.532
10354701		191.347
10356711		191.212
10516470		261.649
10516670		191.213
10516870		191.328
10520001		196.002
10791040	12164740	
11059475		191.158
11060275		191.184
11060576		191.284
11061075		261.354
11061575		261.639
11066976		191.116
11198071		191.381
11198371		261.717
11288021		261.707
11343721		261.715
11500121		191.208
12164321		191.712
12164711		261.704
12164740		191.408
12429820		191.289
12430120		191.288
12575611		191.144
12638670		191.146
12644920		191.317
12683380		211.469
13301401		191.169
13302101		191.348
13302301		191.508
13407211		191.625
13407811		191.268
13408411		191.166
13450110		261.702
13517021		191.306
13517321		191.307
13517921		191.305
13543321		191.113

NUMERO ORIGINALE NUMERO ORIGINAL ORIGINAL NUMBER	NUMERO SOSTITUTIVO REPLACE PAR NUMERO REPLACED BY NUMBER	RIFERIMENTO OMP REFERENCE OMP OMP REFERENCE
13546121		191.111
13550501		191.201
13598121		191.181
13598211		191.316
13746310		191.174
13746330		191.108
13746410	13746330	
13748410		211.997
13748610		191.234
14044171		191.296
14325001		191.182
14453581		191.076
14459781		261.688
15888721		191.327
15896211		261.648
15972021		191.714
16043221		261.677
16043421		191.238
16043721		196.039
16043821		191.378
16043921		211.522
16044521		191.379
16100811		191.214
20556690		211.449
20558440		211.451
20885620		191.286
20888670		191.318
24903330		191.205
24940280		191.163
26794880		191.355
26794890		261.643
28042300		191.187
28042310		191.203
28043180		191.269
28044120		191.185
30002797		191.411
38823313		211.524
42530032		196.446
42530033		196.447
42532082		216.568
61088139		196.355
61142732		212.044
61142733	VEDI 192.186	
61142734		192.027
61142735		212.099
61142736	76029352	
61142737		ESAURO

OGNI RIFERIMENTO ORIGINALE E' ASSOLUTAMENTE INDICATIVO. CHAQUE REFERENCE ORIGINAL EST ABSOLUMENT INDICATIVE. EVERY ORIGINAL PART NUMBER HAS TO BE CONSIDERED FOR REFERENCE PURPOSE ONLY.

TAVOLE DI CONVERSIONE
TABLE DE CONVERSION
CONVERSION TABLE

IVECO



NUMERO ORIGINALE NUMERO ORIGINAL ORIGINAL NUMBER	NUMERO SOSTITUTIVO REPLACE PAR NUMERO REPLACED BY NUMBER	RIFERIMENTO OMP REFERENCE OMP OMP REFERENCE
61142738	VEDI 192.151	
61142739	1902654	
61142740	1902655	
61142741	1902656	
61204018		211.549
61204029		211.318
61206228		211.557
61208017		211.554
61217306		211.550
61218964	61234594	
61218967		211.541
61219151		211.553
61219373		211.542
61219580	61577570	
61219581	61234595	
61219616		211.570
61219835	61516822	
61225614		211.552
61227279		218.145
61231294		211.564
61233720		211.559
61233721		211.561
61234314		218.146
61234418		218.147
61234594		211.565
61234595		211.560
61235003		211.562
61237013		211.547
61315464		196.450
61316037	61317704	
61317704	99445369	
61318938		196.615
61318939		196.475
61321400		196.434
61400010	61520146	
61400040		211.544
61400121	61802551	
61414596		211.543
61516822		211.558
61520146		211.567
61577186		
61577570		211.563
61578828		
61580741		196.088
61581078		
61581081		
61581151		

NUMERO ORIGINALE NUMERO ORIGINAL ORIGINAL NUMBER	NUMERO SOSTITUTIVO REPLACE PAR NUMERO REPLACE BY NUMBER	RIFERIMENTO OMP REFERENCE OMP OMP REFERENCE
61581159		191.121
61581201		196.089
61581254		191.713
61581261		191.693
61581300		191.694
61581302		261.299
61581308		191.691
61581310		191.692
61581715		191.698
61582377		191.696
61582378		191.695
61582396		196.087
61582702		198.179
61583514		191.699
61583516		191.701
61583705		198.335
61583710		191.687
61583711		198.264
61583902		198.214
61583909		ESAURITO
61584445		196.079
61584786		191.122
61584976		198.253
61585140		261.716
61585894		198.332
61586021		198.338
61586202		198.336
61586460		196.292
61586443		196.094
61586464		198.334
61586467		196.083
61664874		211.545
61670940		211.540
61674099		ESAURITO
61674183	61690376	
61686243		ESAURITO
61686250	61690371	
61686703	61690374	
61686914	61690369	
61687070		ESAURITO
61687076	61690370	
61687575		
61688006	61690510	
61688480		
61689731		
61690042	61690384	
61690369		196.350

OGNI RIFERIMENTO ORIGINALE E' ASSOLUTAMENTE INDICATIVO. CHAQUE REFERENCE ORIGINAL EST ABSOLUMENT INDICATIVE. EVERY ORIGINAL PART NUMBER HAS TO BE CONSIDERED FOR REFERENCE PURPOSE ONLY.

TAVOLE DI CONVERSIONE
TABLE DE CONVERSION
CONVERSION TABLE

IVECO (FIAT - OM - UNIC



NUMERO ORIGINALE NUMERO ORIGINAL ORIGINAL NUMBER	NUMERO SOSTITUTIVO REPLACE PAR NUMERO REPLACED BY NUMBER	RIFERIMENTO OMP REFERENCE OMP OMP REFERENCE
61690370		196.375
61690371		196.330
61690374		196.340
61690375		196.345
61690376		196.365
61690377		196.300
61690384		196.290
61690390	61690490	
61690490		196.360
61690510		196.305
61690511		196.410
61801013		211.546
61801710		191.711
61802551		211.568
61815006		211.201
61815039	61815054	
61815054		211.566
61836005		211.548
61844024		211.191
64142737		192.095
76029352		222.260
76030102		222.263
76031329		222.262
79014642		201.960
79046176		202.123
79046185		222.141
79047638		222.125
93190284		196.293
93190285	98479675	
93190286	42530032	
93190287	42530033	
93190288		196.251
93191101		196.319
93191102		196.328
93191103		196.318
93191104		196.329
93802841		191.112
98403016	4813370	
98410023		206.435
98415831		196.650
98418986	98435994	
98421056	98487547	
98421538	98468832	
98424097		926.187
98435994	99459757	
98437727	98438357	
98438356	99438900	

NUMERO ORIGINALE NUMERO ORIGINAL ORIGINAL NUMBER	NUMERO SOSTITUTIVO REPLACE PAR NUMERO REPLACED BY NUMBER	RIFERIMENTO OMP REFERENCE OMP OMP REFERENCE
98438357	99448066	
98439407	99448068	
98439476		216.278
98455464		926.207
98487547		926.183
98463962		926.206
98465322	98497117	
98468830	99458098	
98468832	99458099	
98447661		196.485
98476458		196.578
98479675	99445447	
98479917		216.306
98497115		196.342
98497117		226.334
99433058	99448068	
99438900		196.460
99440717		
99440726	99440728	
99440727	= 99440728	
99440728		196.549
99445369		926.421
99445447		216.419
99448066		196.427
99448068		196.465
99453848		196.432
99458098		196.436
99458099		196.438
99459757		196.230
500300470		196.347
500300476	99438900	
500300477	99448068	

OGNI RIFERIMENTO ORIGINALE E' ASSOLUTAMENTE INDICATIVO. CHAQUE REFERENCE ORIGINAL EST ABSOLUMENT INDICATIVE. EVERY ORIGINAL PART NUMBER HAS TO BE CONSIDERED FOR REFERENCE PURPOSE ONLY.

SUITABLE

IVECO

FIAT AUTO AUTOCARRI LEGGERI - CAMIONETTE - MINITRUCKS

Tel: +44(0)1925 850082 Fax: +(0)44 1925 850083

www.spwaterpumps.co.uk

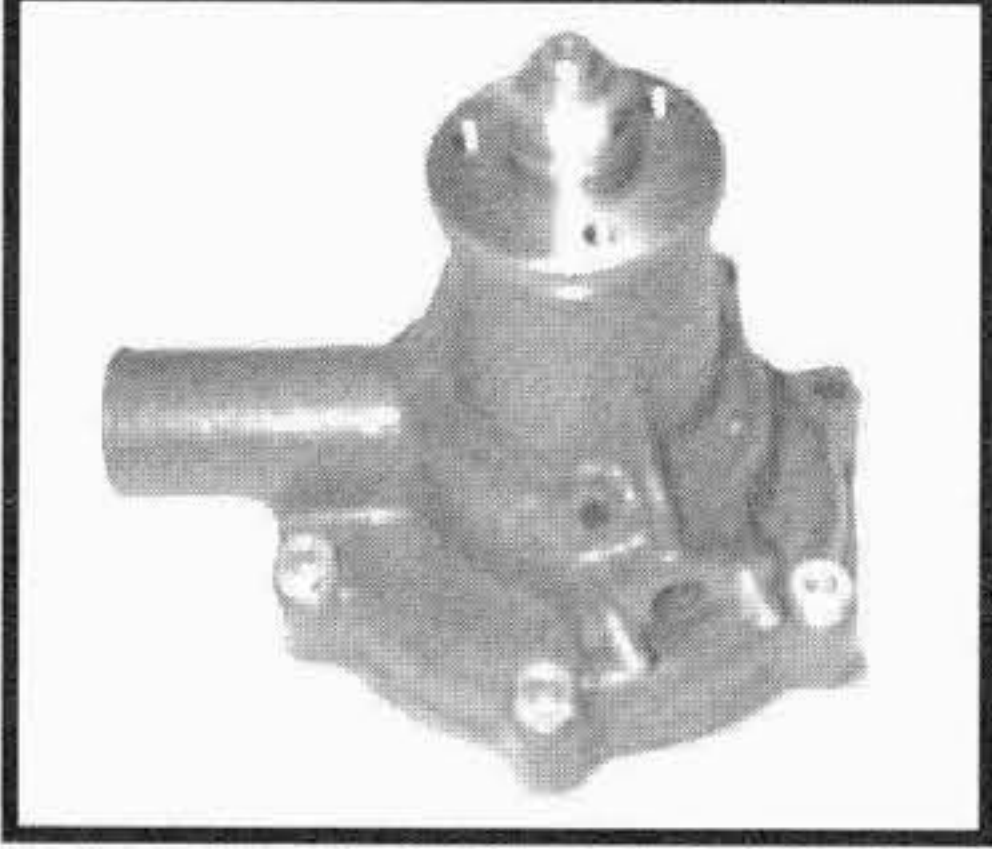
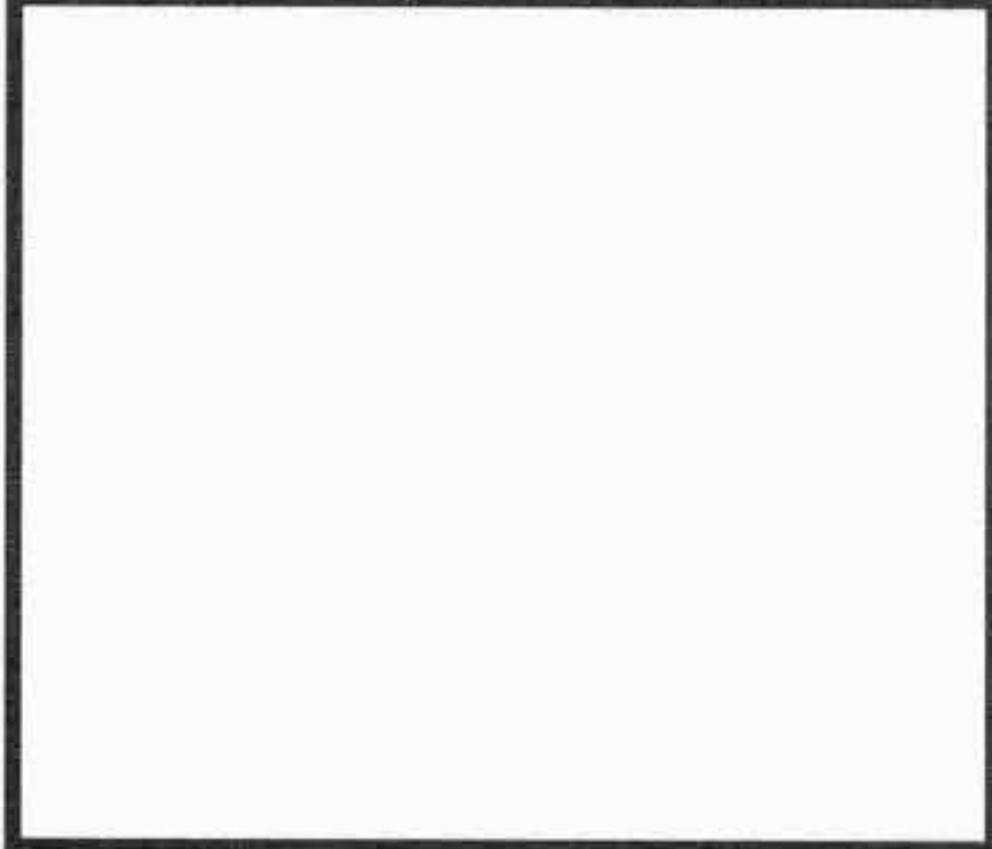
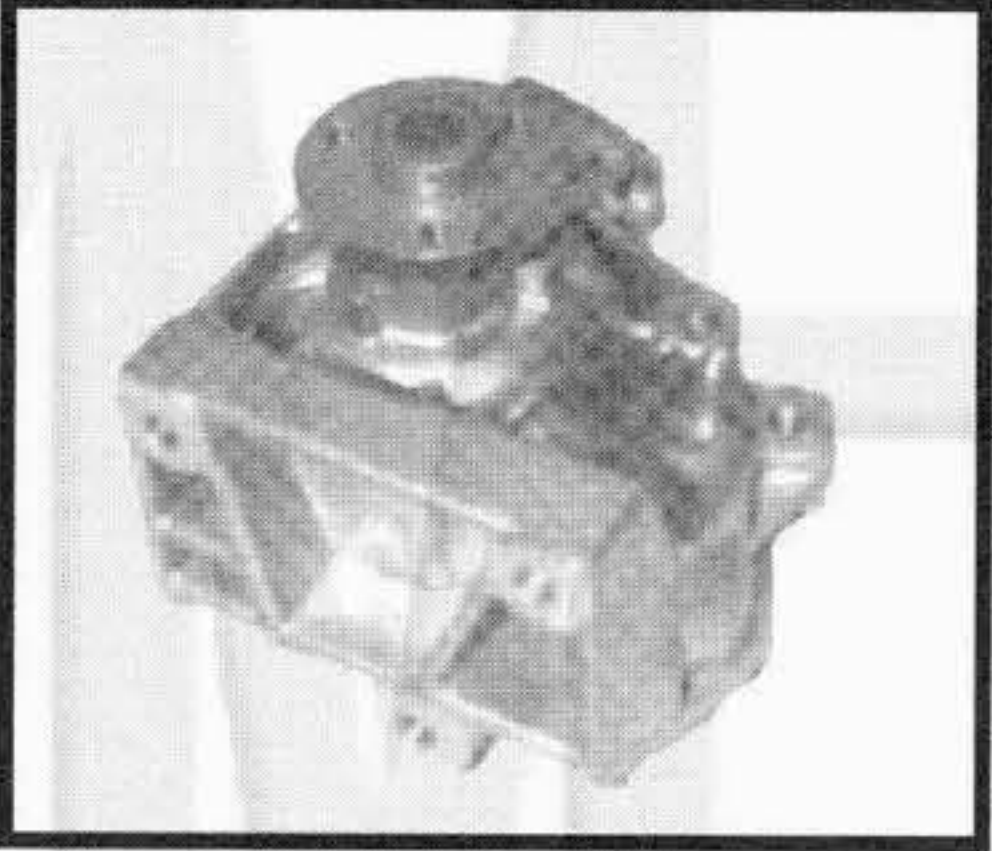
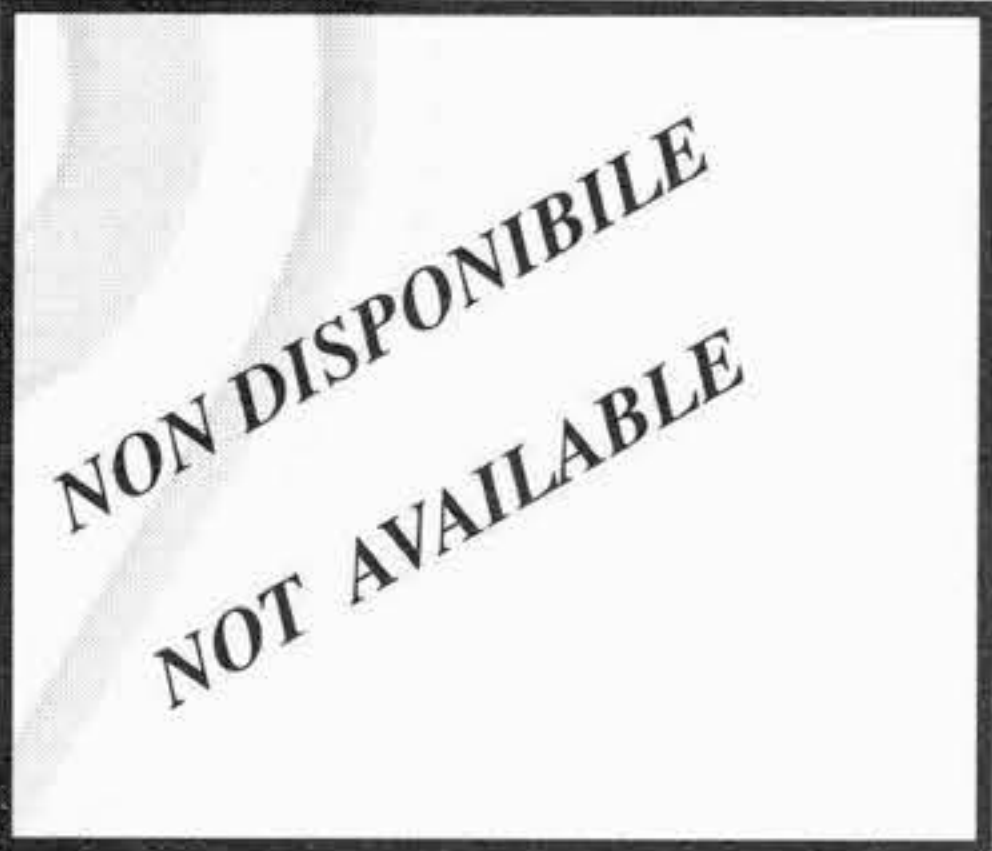
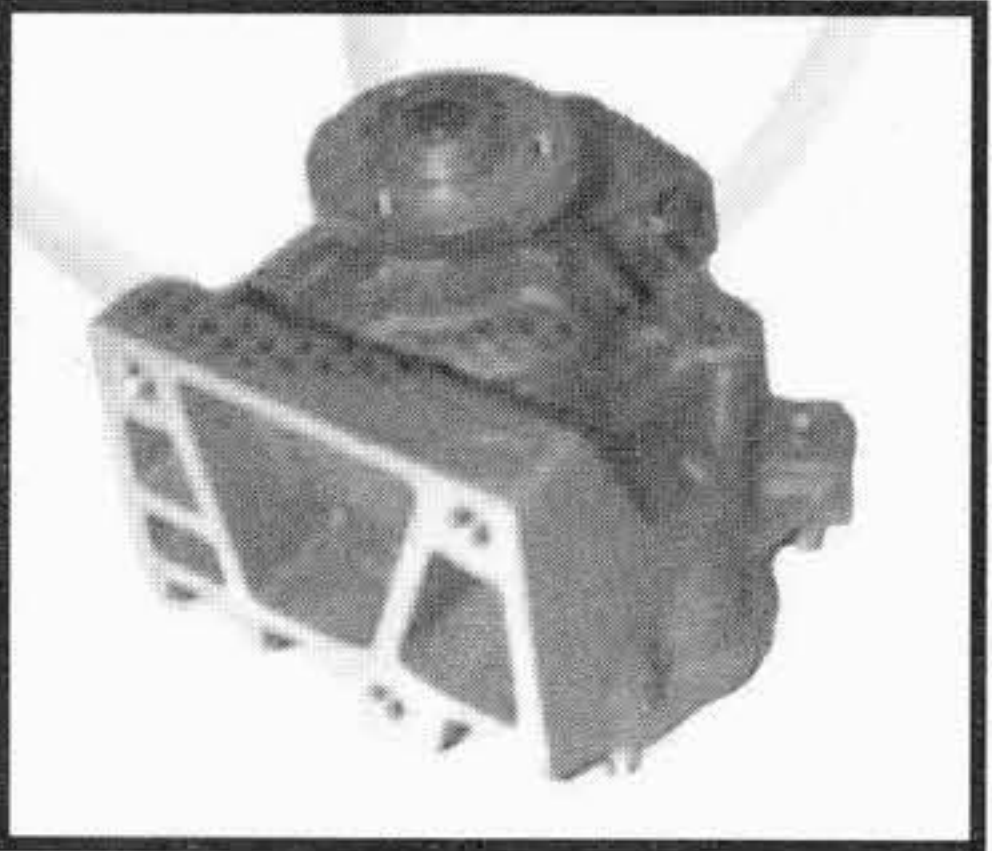
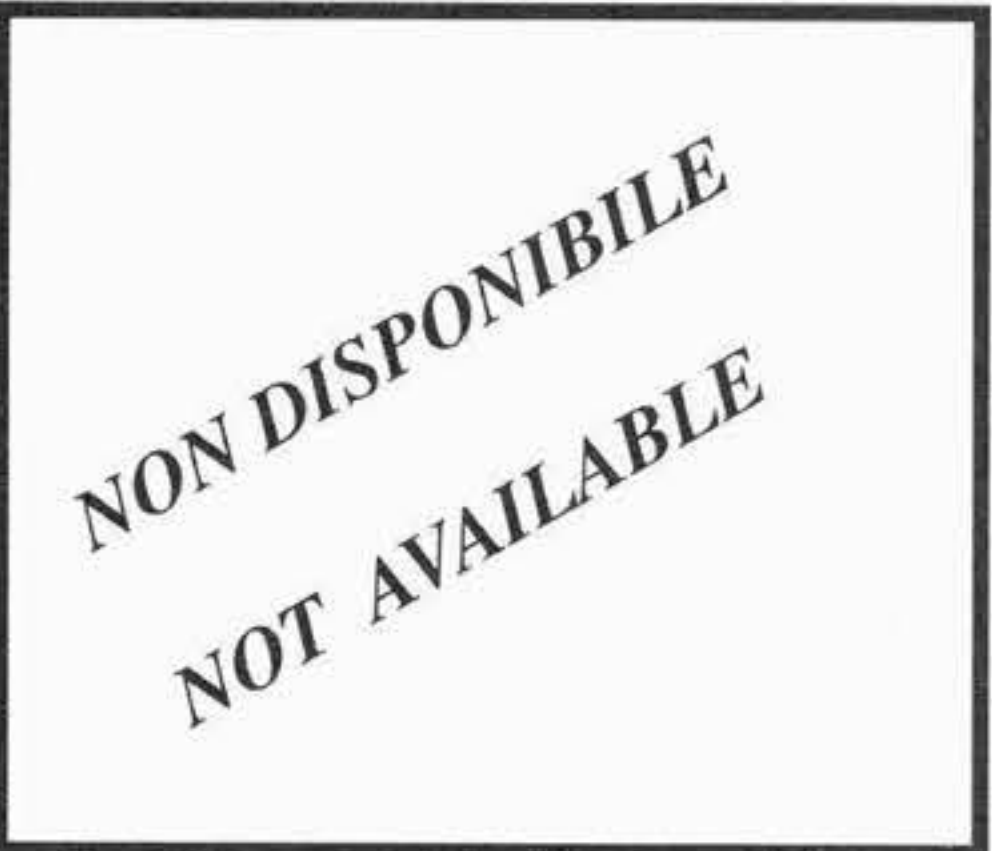
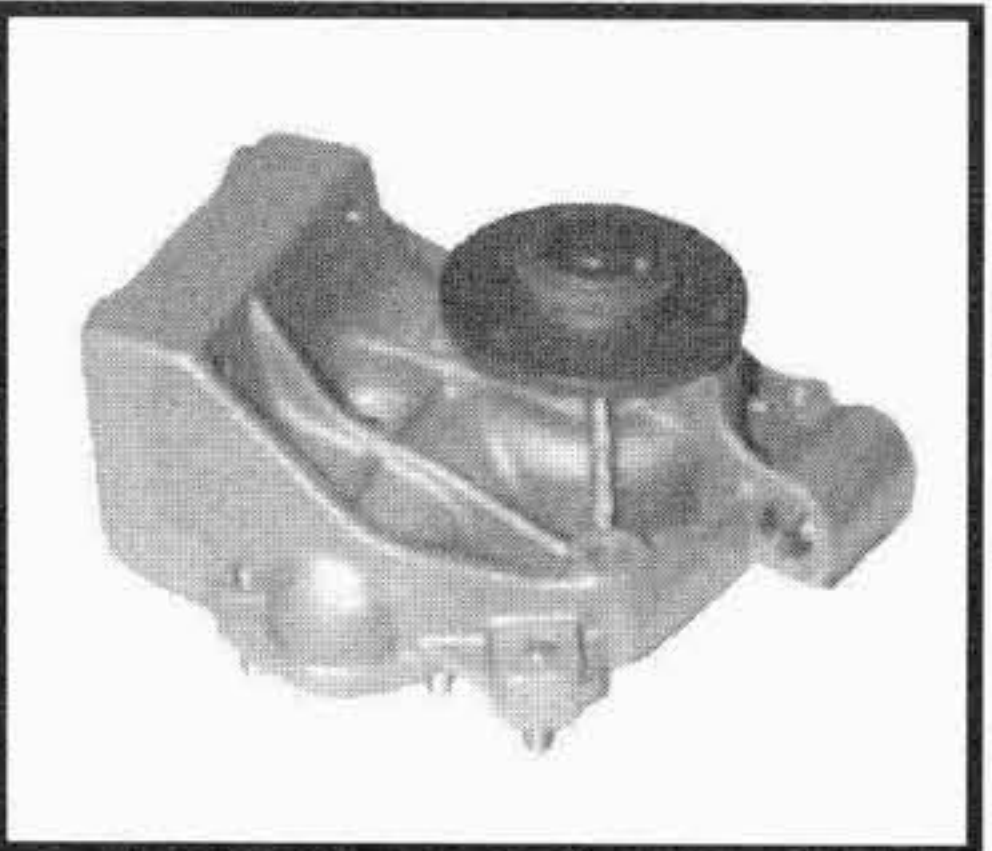
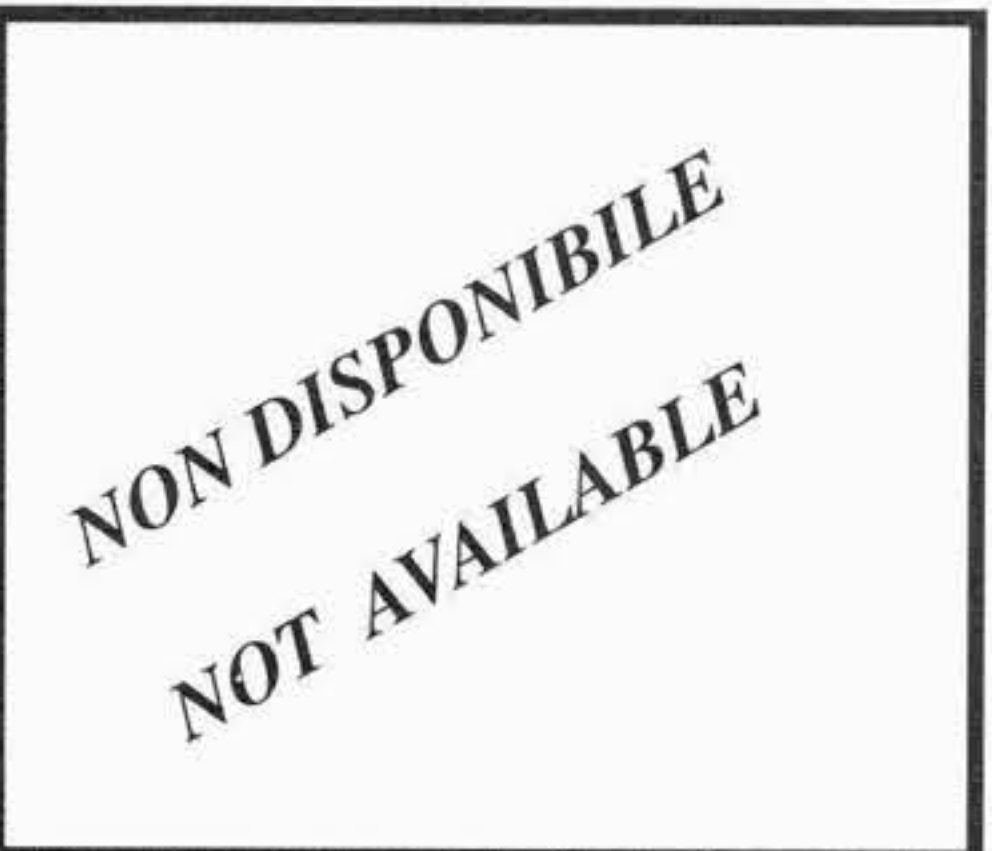

TIPO O MODELLO TYPE OU MODELE TYPE OR MODEL	MOTORE MOTEUR ENGINE	POMPA ACQUA POMPE A EAU WATER PUMP	KIT RIPARAZIONE NECESSAIRE DE REP. REPAIR KIT
		OMP REF. / O.EM. REF	OMP REF. / O.EM. REF
241 TN	237.AZ.000	191.200 4654872 	192.006 --- 
DUCATO D DUCATO TURBO D DUCATO MAXI TURBO D MARENGO 1983----> 1986	8144.61.200 54 / 75 8144.21 68 / 92 8144.61	196.185 7303030 	--- --- 
DUCATO D DUCATO TURBO D DUCATO MAXI TURBO D MARENGO 1986 ----> 1993	8144.61.200 54 / 75 8144.21 68 / 92 8144.61	196.420 4823810 	--- --- 
DUCATO D DUCATO TURBO D DUCATO MAXI TURBO D MARENGO 1994 ---->	8140.47.2200	--- 99440717 	--- --- 

I ricambi non sono originali ma adattabili . Ogni riferimento originale é assolutamente indicativo .
 Spare parts are not original but perfectly suitable . Every original part number has to be considered for reference purpose only .

SUITABLE

IVECO

AUTOCARRI - CAMIONS - TRUCKS - LKW

Tel: +44(0)1925 850082 Fax: +(0)44 1925 850083

www.spwaterpumps.co.uk

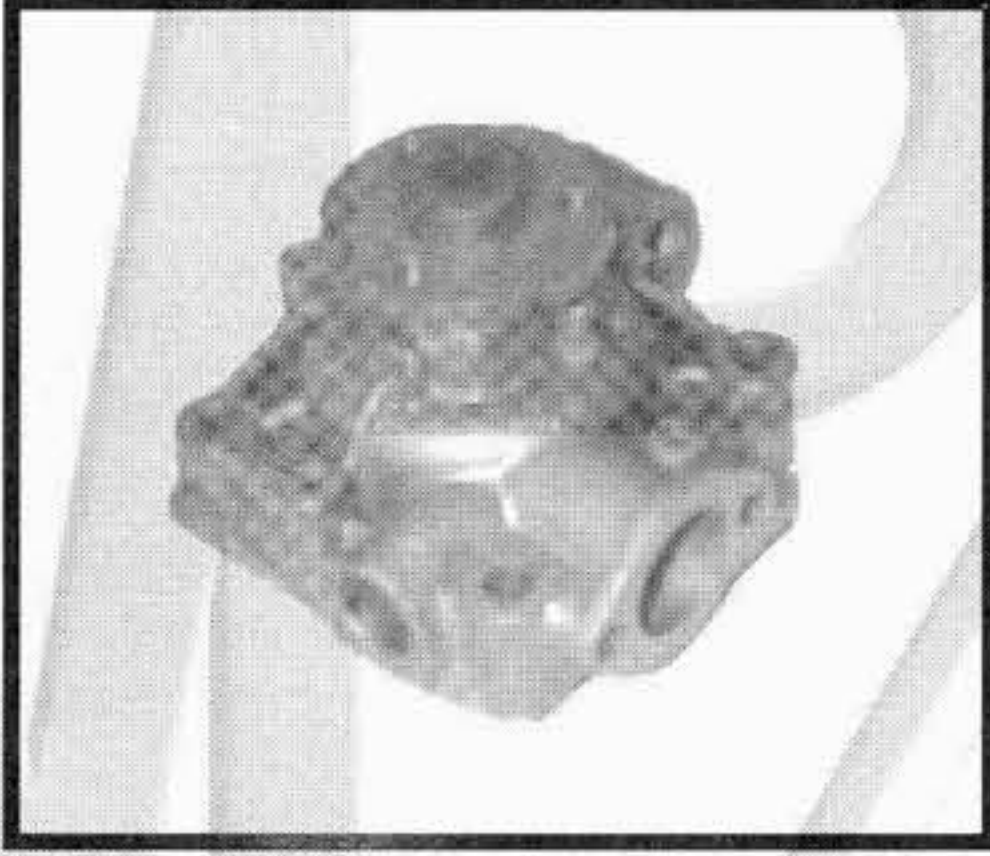
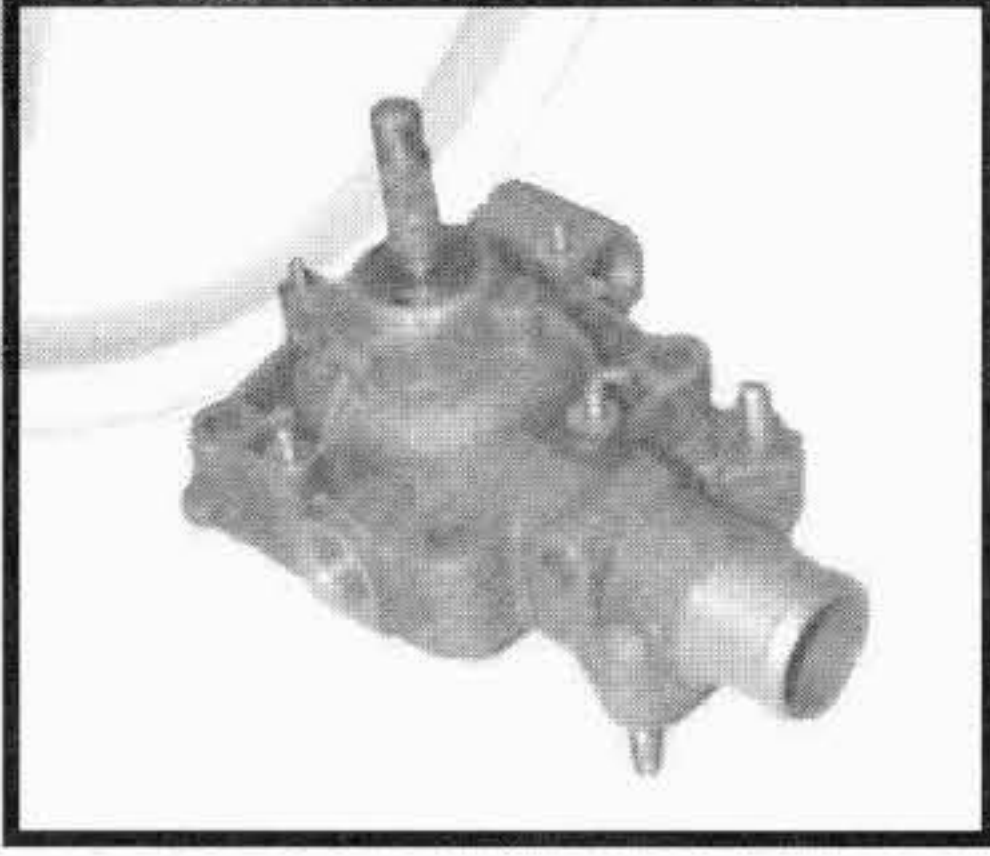
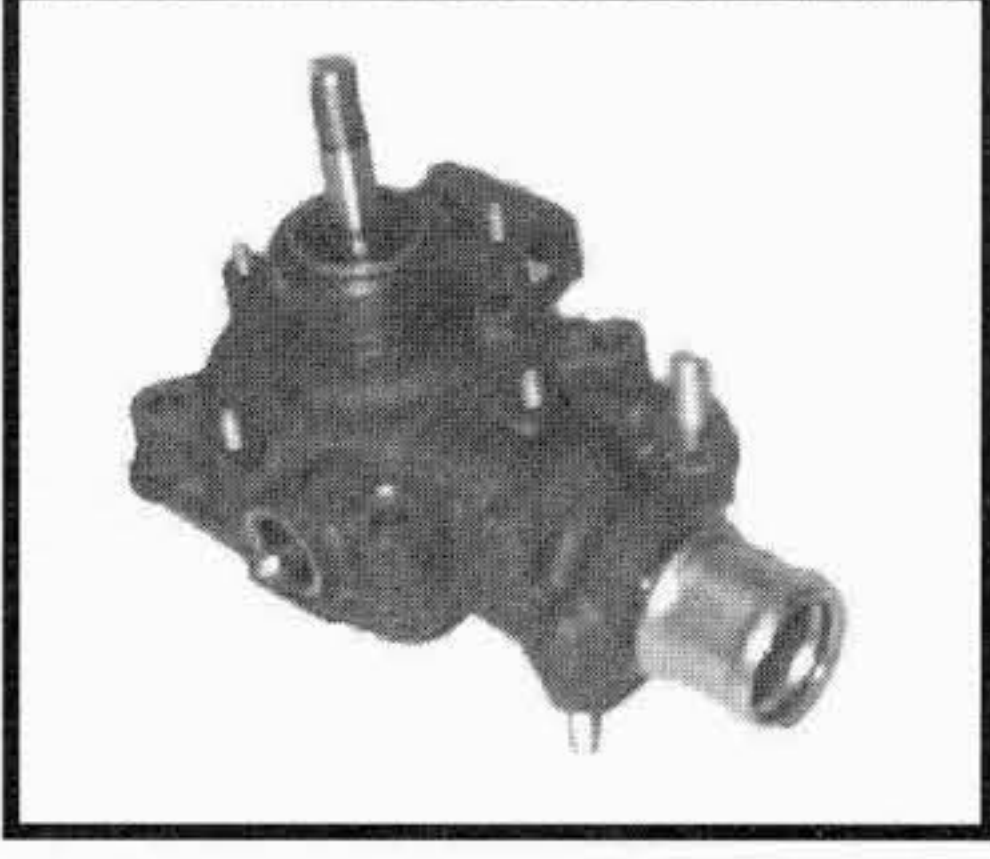

TIPO O MODELLO TYPE OU MODELE TYPE OR MODEL	MOTORE MOTEUR ENGINE	POMPA ACQUA POMPE A EAU WATER PUMP	KIT RIPARAZIONE NECESSAIRE DE REP. REPAIR KIT
<p>DAILY</p> <p>28.8 - 30.8 - 32.8 - 35.8 - 40.8</p> <p>NEW DAILY</p> <p>30.8 - 35.8 - 40.8</p>	<p>8140.61.200 53 / 72</p> <p>4 cyl. 2500 cm³</p>	<p>196.549 99440728</p> 	<p>NON DISPONIBILE NOT AVAILABLE</p>
<p>35.10 - 45.10 - 49.10</p> <p>40.10 W (4 X 4)</p>	<p>8140.61.204 68 / 92</p> <p>8140.27.215 76 / 103</p>	<p>196.190 7303056</p> 	<p>NON DISPONIBILE NOT AVAILABLE</p>
<p>35.8</p> <p>35.10</p> <p>35.12 TURBODAILY</p> <p><i>con elettroventilatore avec ventilateur electric with electric fan</i></p>	<p>8140.07 ---> fino al motore n° 1422291</p> <p>8140.27</p>	<p>196.230 99459757</p> 	<p>NON DISPONIBILE NOT AVAILABLE</p>
<p>35.10 TURBODAILY</p> <p>NEW DAILY</p> <p>35.10 - 40.10 - 49.10</p> <p><i>con elettroventilatore avec ventilateur electric with electric fan</i></p>	<p>8140.47R 4 cyl. 2500 cm³ turbo</p> <p>4 cyl. 2800 cm³ turbo</p>	<p>196.465 99448068</p> 	<p>NON DISPONIBILE NOT AVAILABLE</p>

I ricambi non sono originali ma adattabili . Ogni riferimento originale é assolutamente indicativo .

Spare parts are not original but perfectly suitable . Every original part number has to be considered for reference purpose only .

SUITABLE

IVECO

AUTOCARRI - CAMIONS - TRUCKS - LKW

Tel: +44(0)1925 850082 Fax: +(0)44 1925 850083

www.spwaterpumps.co.uk

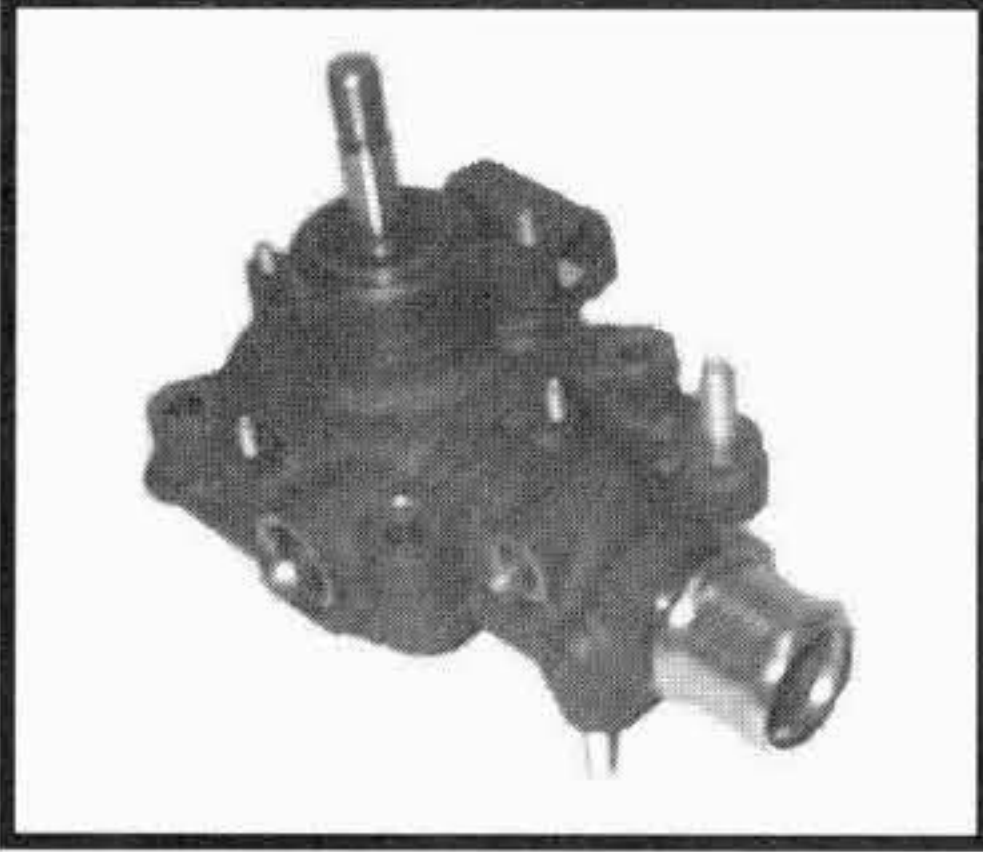
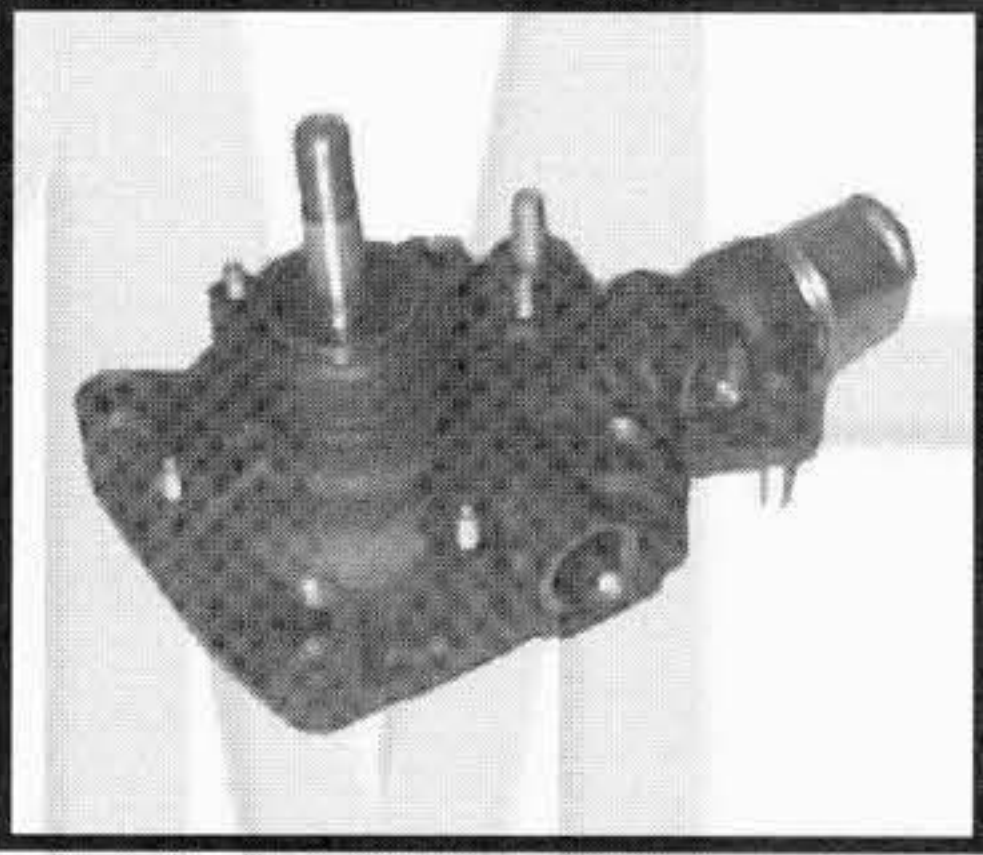
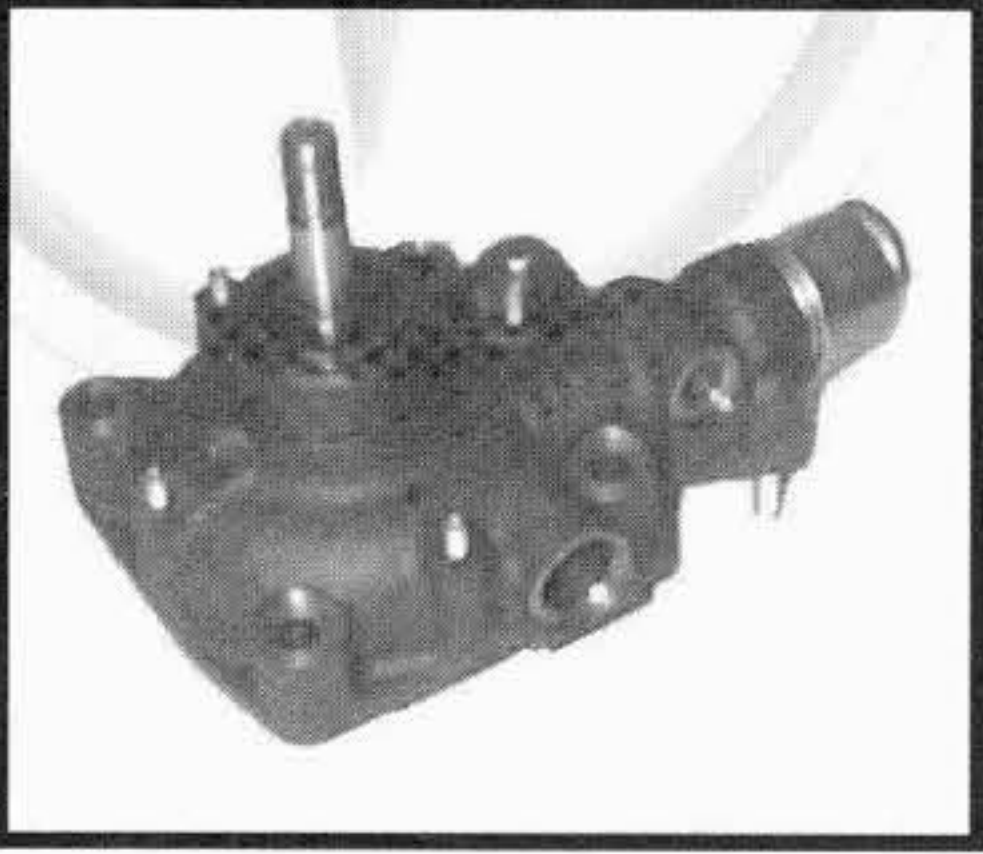
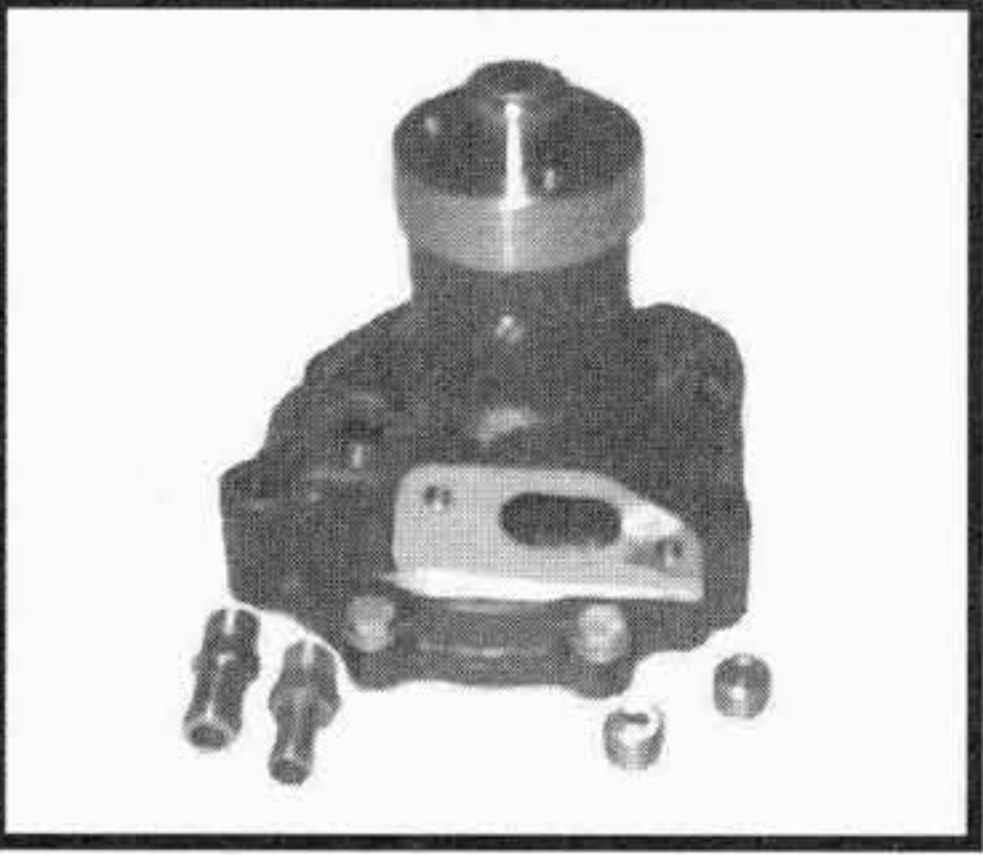

TIPO O MODELLO TYPE OU MODELE TYPE OR MODEL	MOTORE MOTEUR ENGINE	POMPA ACQUA POMPE A EAU WATER PUMP	KIT RIPARAZIONE NECESSAIRE DE REP. REPAIR KIT
<p>35.12 TURBODAILY</p> <p>NEW DAILY</p> <p><i>con elettroventilatore avec ventilateur electric with electric fan</i></p>	<p>8140.27S 4 cyl. 2500 cm³ turbo intercooler</p> <p>4 cyl. 2800 cm³ turbo intercooler</p>	<p>196.460 99438900</p> 	<p>NON DISPONIBILE NOT AVAILABLE</p>
<p>40.10 W TURBODAILY 4x4</p> <p>NEW DAILY</p> <p>40.10 W 4 x 4</p> <p><i>con elettroventilatore avec ventilateur electric with electric fan</i></p>	<p>8140.27S 4 cyl. 2500 cm³ turbo</p>	<p>196.427 99448066</p>  <p>note : sostituisce / replace alluminium body -</p>	<p>NON DISPONIBILE NOT AVAILABLE</p> <p>98437727 - corpo in alluminio cuscinetto / bearing Ø 30 mm</p>
<p>40.12 WM TURBODAILY 4x4</p> <p>variante CANADA</p> <p><i>con elettroventilatore avec ventilateur electric with electric fan</i></p>		<p>196.578 98476458</p> 	<p>NON DISPONIBILE NOT AVAILABLE</p>
<p>50.8 1,2,3 Serie</p> <p>50.9</p> <p>55.8</p> <p>60.8 1,2,3 Serie</p> <p>80.14</p> <p>80.16 - 80.16 A</p> <p>90 PC (4 X 4)</p>	<p>8040.04.200</p> <p>8040.05 65 / 88</p> <p>8040.04.200</p> <p>8040.04</p> <p>8060.04</p> <p>8060.24</p> <p>8060.02.070</p>	<p>196.319 93191101</p> 	<p>222.260 76029352</p>

I ricambi non sono originali ma adattabili . Ogni riferimento originale é assolutamente indicativo .
Spare parts are not original but perfectly suitable . Every original part number has to be considered for reference purpose only .

SUITABLE



IVECO

AUTOCARRI - CAMIONS - TRUCKS - LKW

Tel: +44(0)1925 850082 Fax: +(0)44 1925 850083

www.spwaterpumps.co.uk

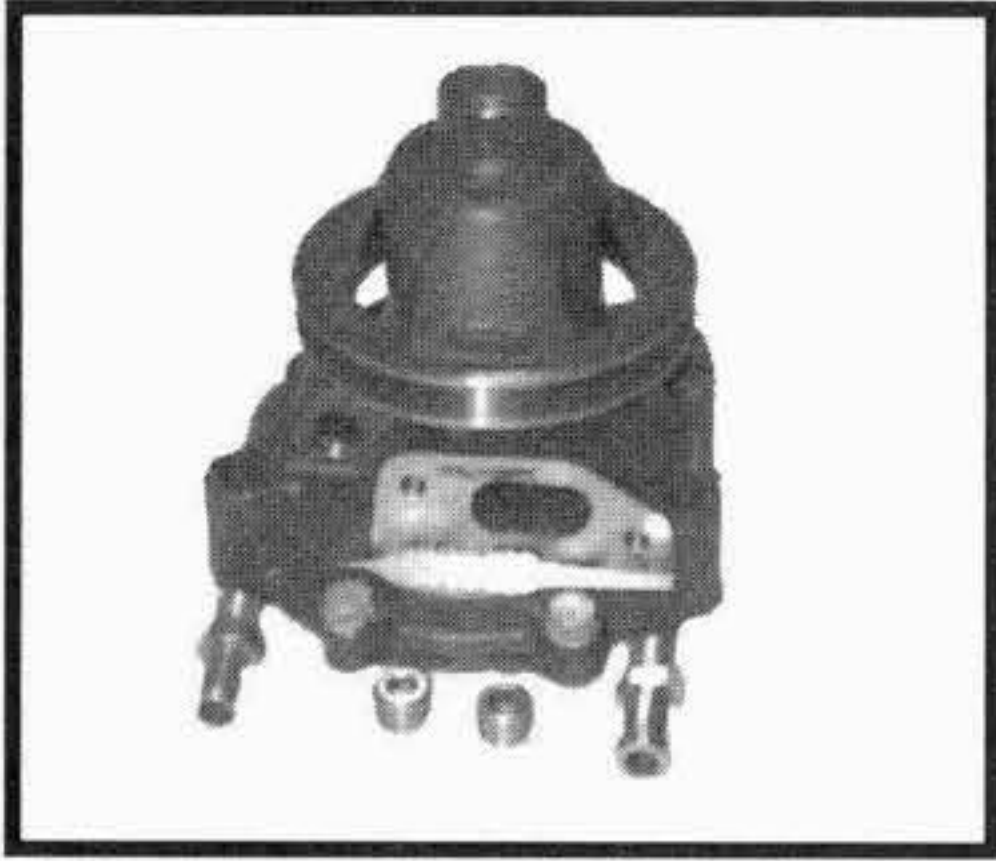
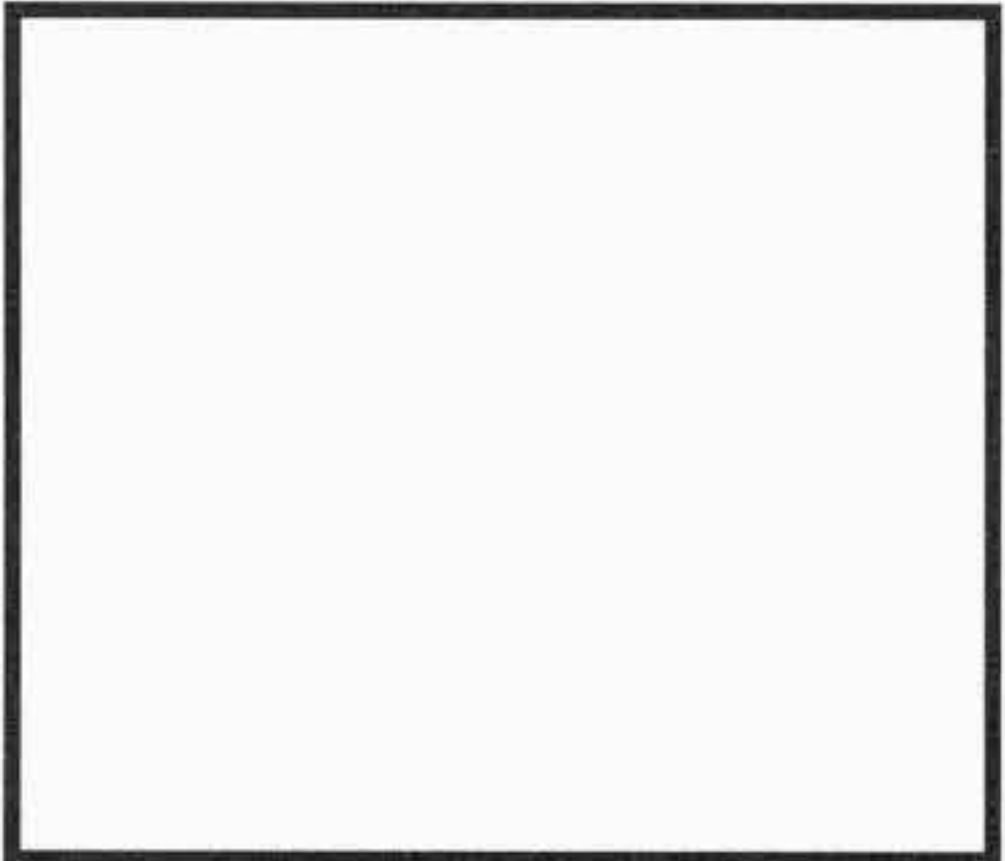
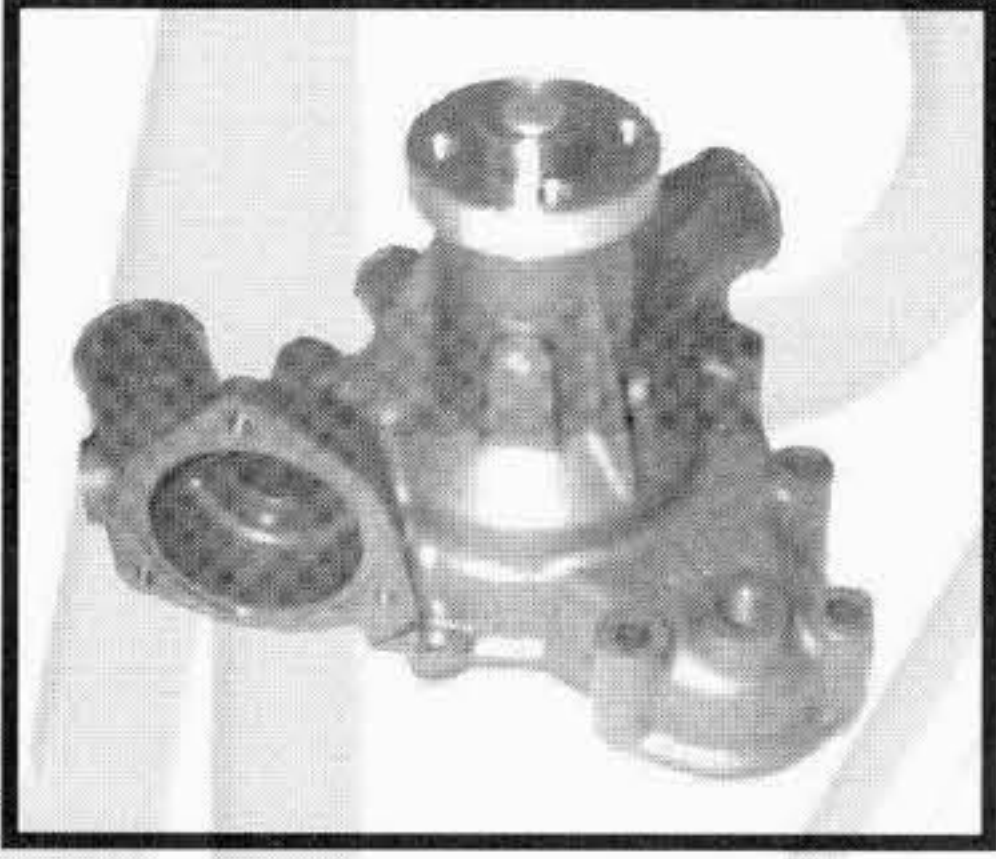
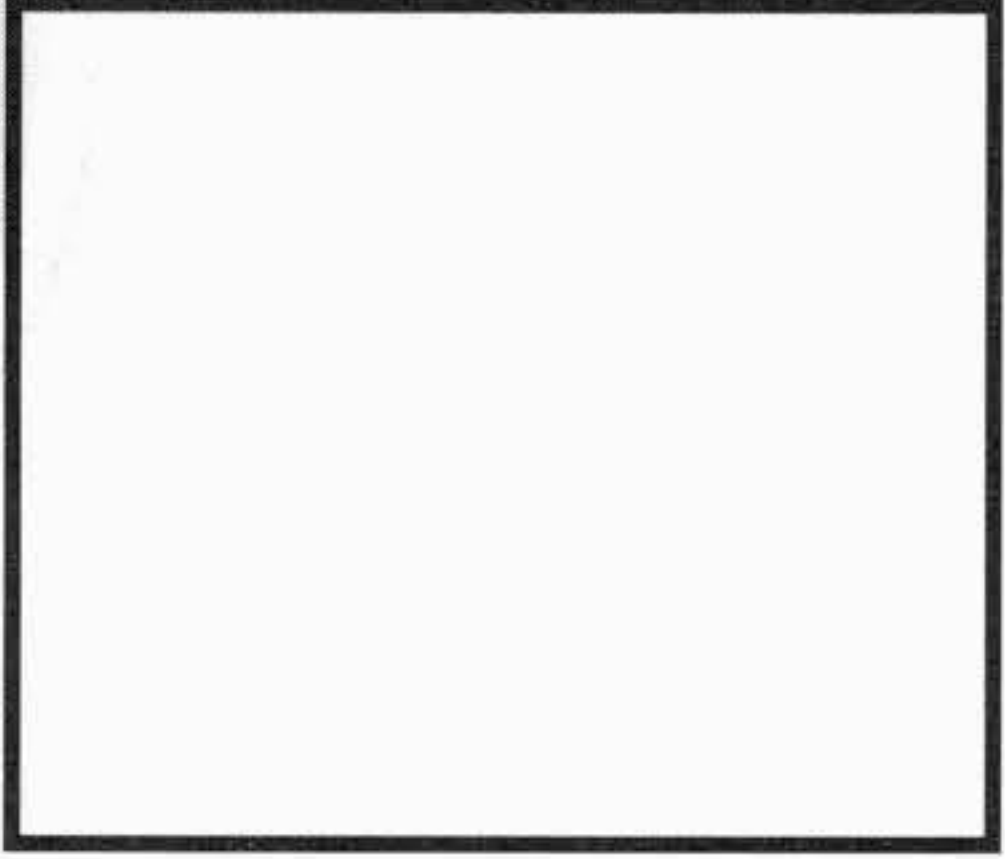

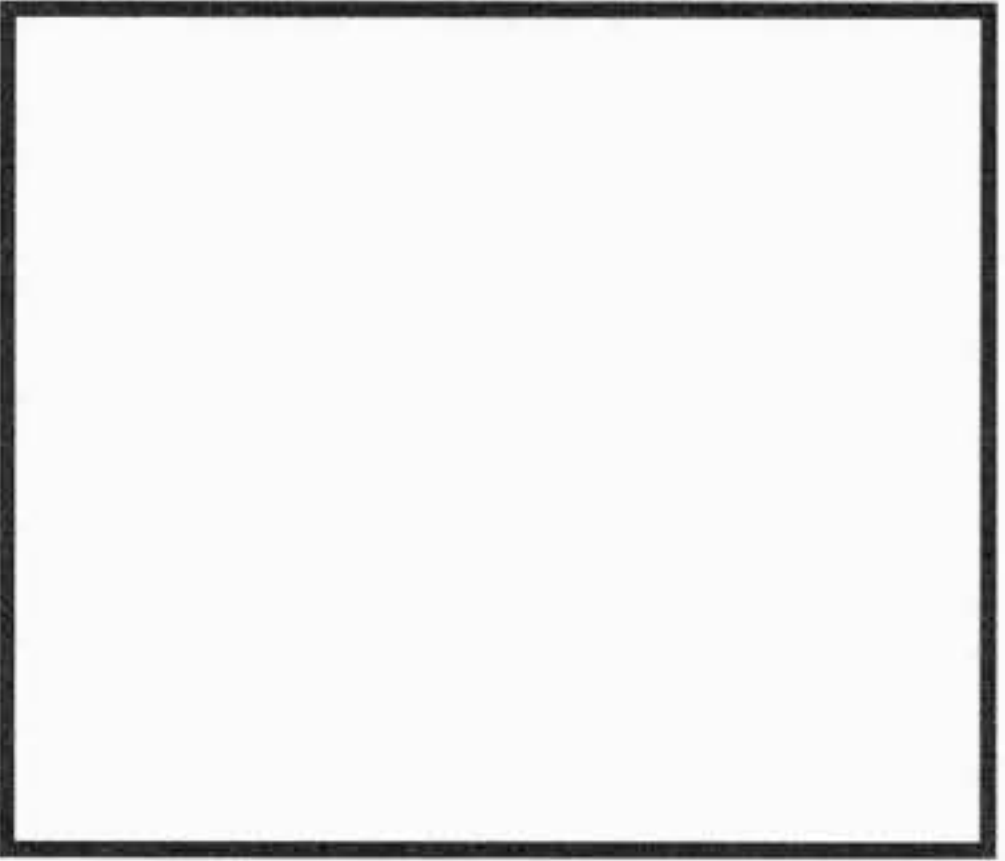
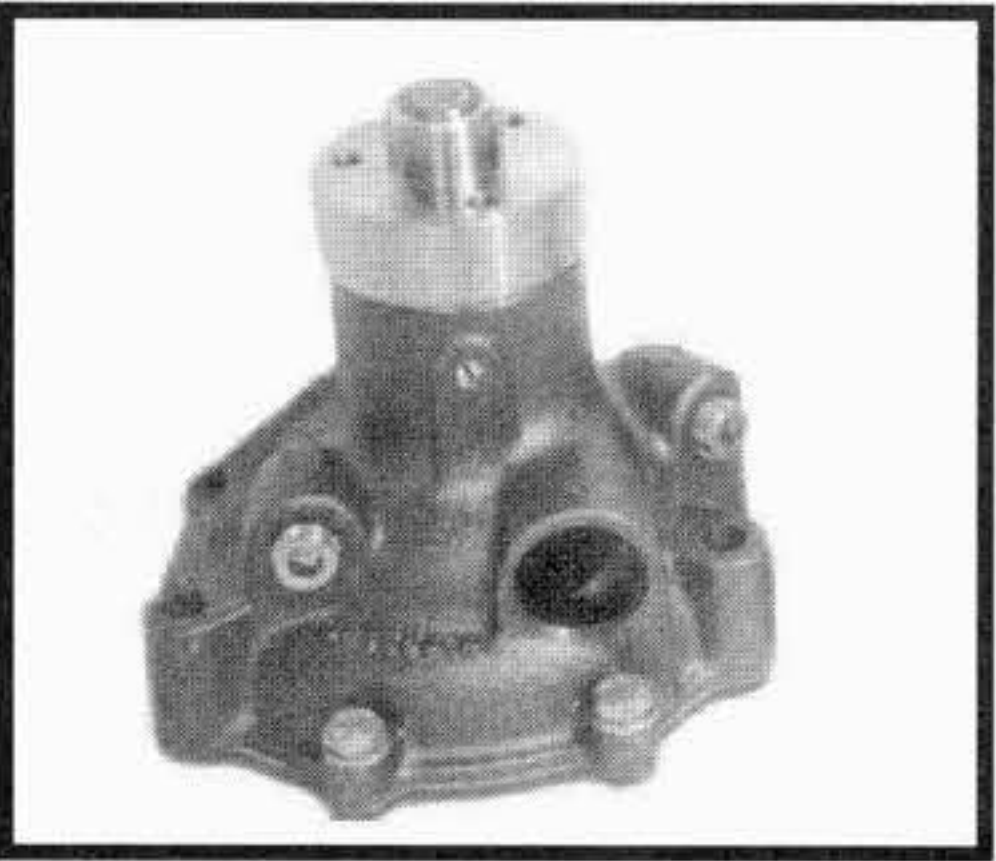
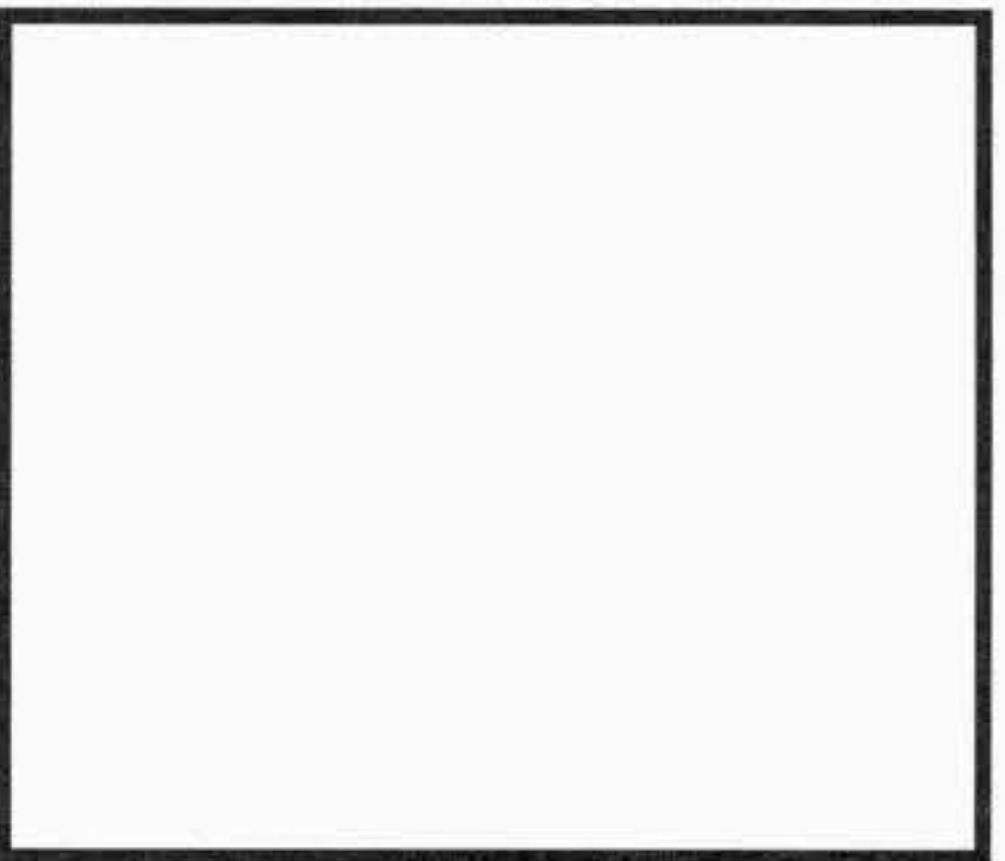
TIPO O MODELLO TYPE OU MODELE TYPE OR MODEL	MOTORE MOTEUR ENGINE	POMPA ACQUA POMPE A EAU WATER PUMP	KIT RIPARAZIONE NECESSAIRE DE REP. REPAIR KIT
50.8 2 Serie con servo sterzo 79.13 1,2 Serie 79.14 3 Serie 80.13 - 80.13 A 90.13 - 90.13 A 100.13 110.14 120.13	8040.04.230/.238 8060.04 99 / 135 8060.04 8060.04 8060.04.639 8060.04.030	196.318 93191103 	192.018 --- 
50.9 - 50.10 1,2,3 Serie 55.9 - 55.10 60.10 1,2,3 Serie 65.10 1,2,3 Serie 70.10 75.10 79.10 1,2,3 Serie	8340.04 8340.04 8340.04	196.175 4796535 	192.151 --- 
Gamma Z 1 / 87 --- 12 / 91 50.9 60.11 65.9 79.12	8040.05 -8060.25 8040.05 8060.25	206.265 4813370 	222.264 1940105 
50.9 ZETA 1992 --->	8040.05	226.334 98497117 	222.264 1940105 

I ricambi non sono originali ma adattabili . Ogni riferimento originale é assolutamente indicativo .

Spare parts are not original but perfectly suitable . Every original part number has to be considered for reference purpose only .

SUITABLE



IVECO

AUTOCARRI - CAMIONS - TRUCKS - LKW

Tel: +44(0)1925 850082 Fax: +(0)44 1925 850083

www.spwaterpumps.co.uk

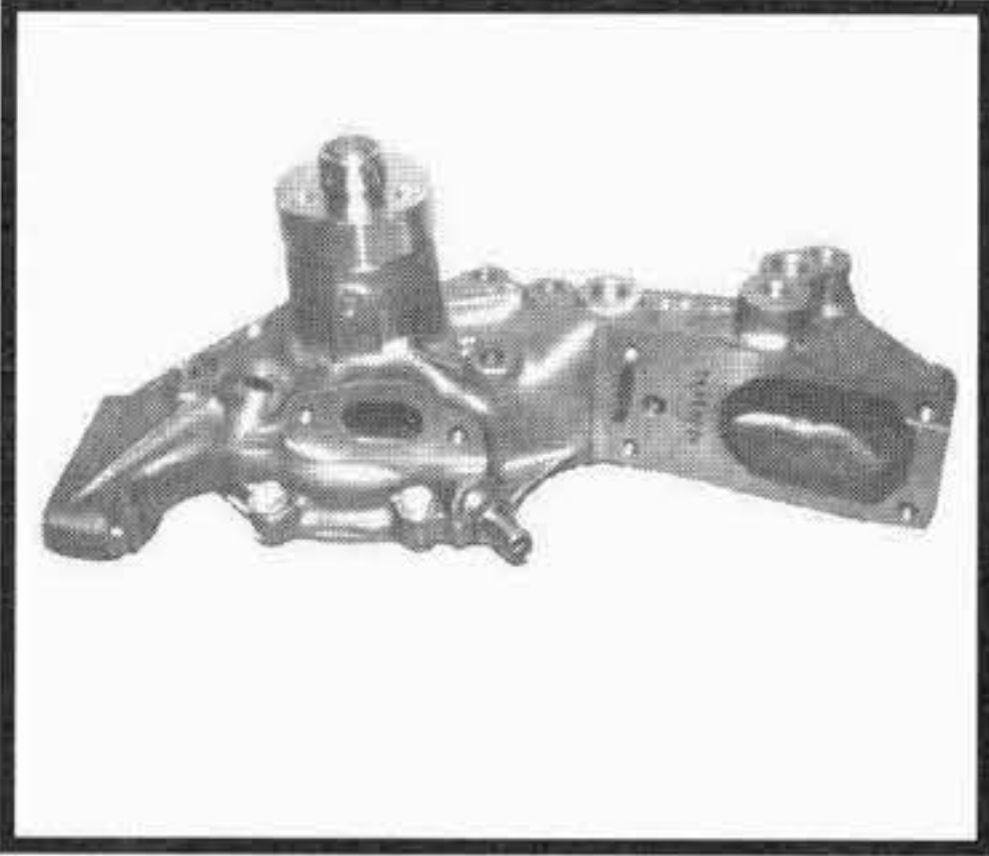
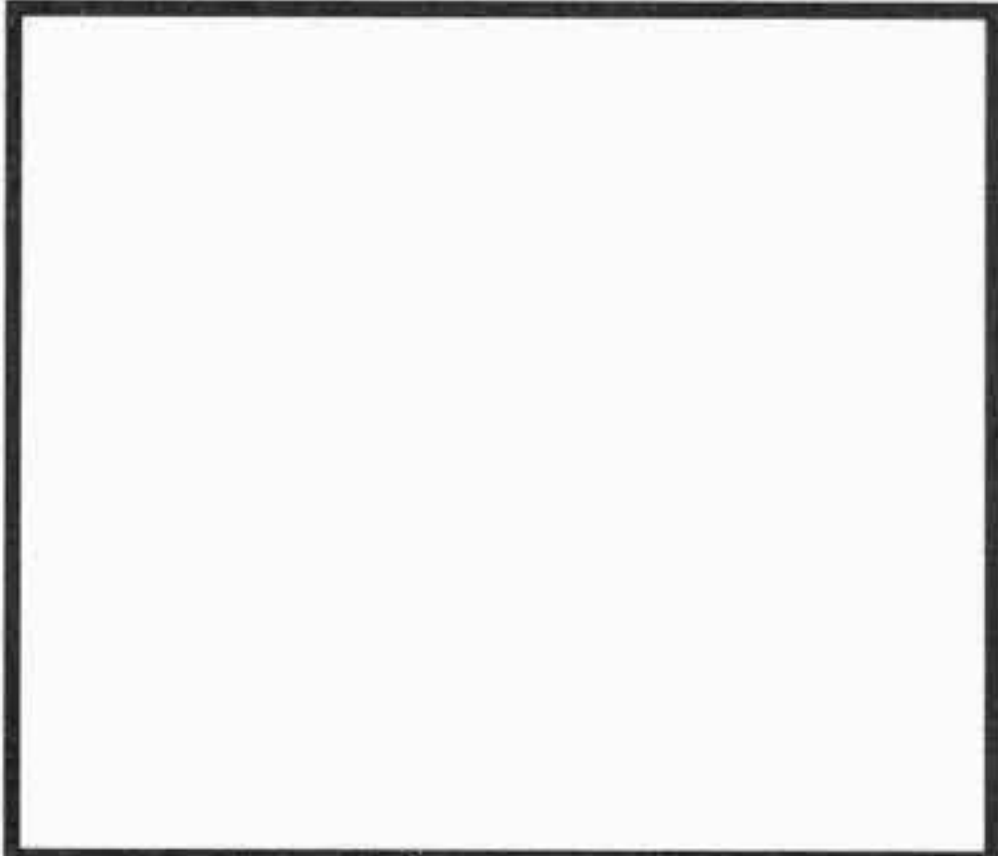
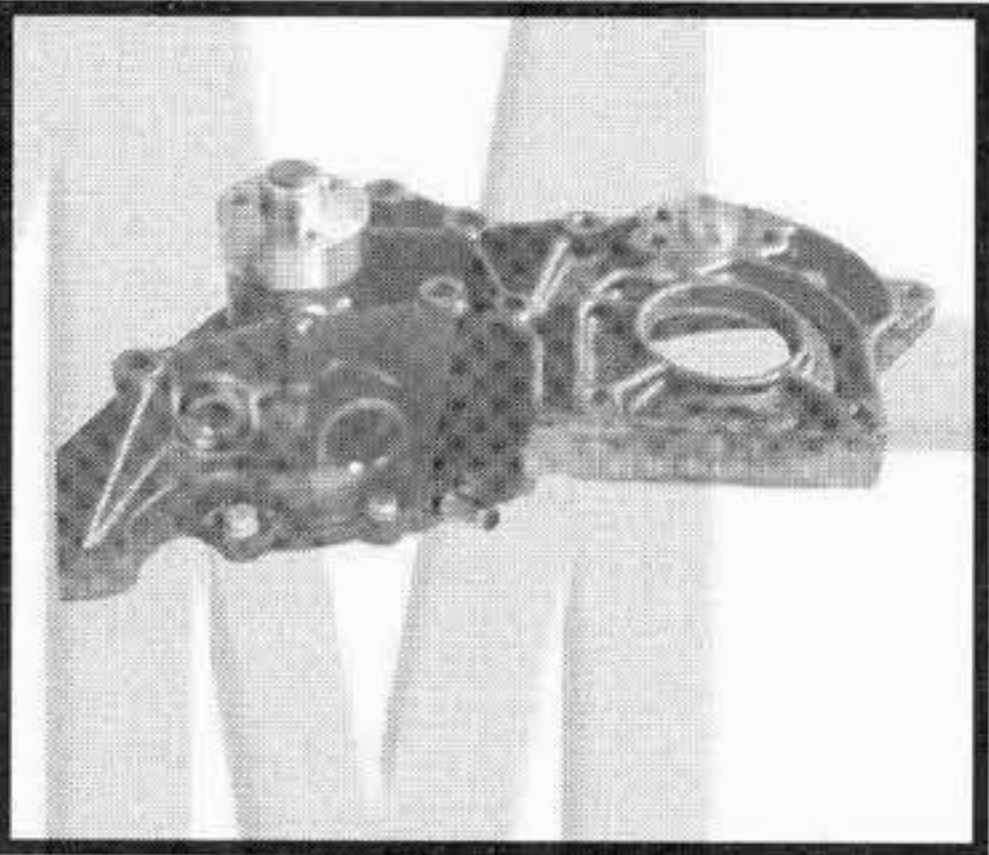
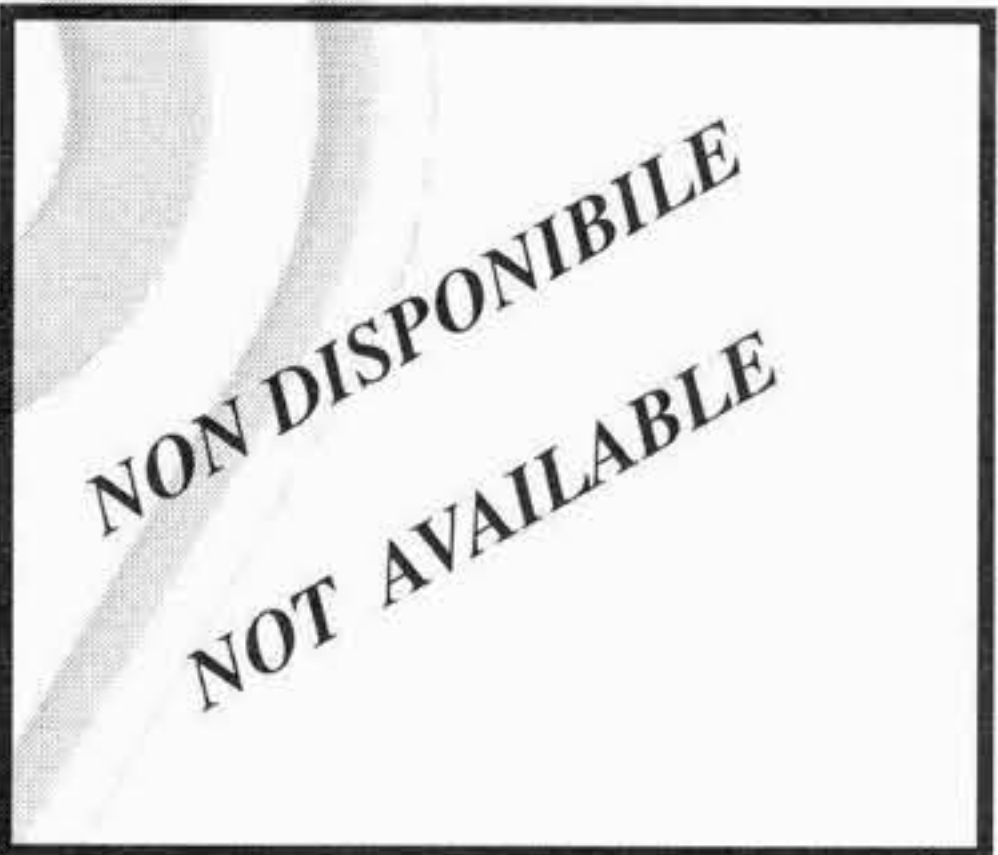

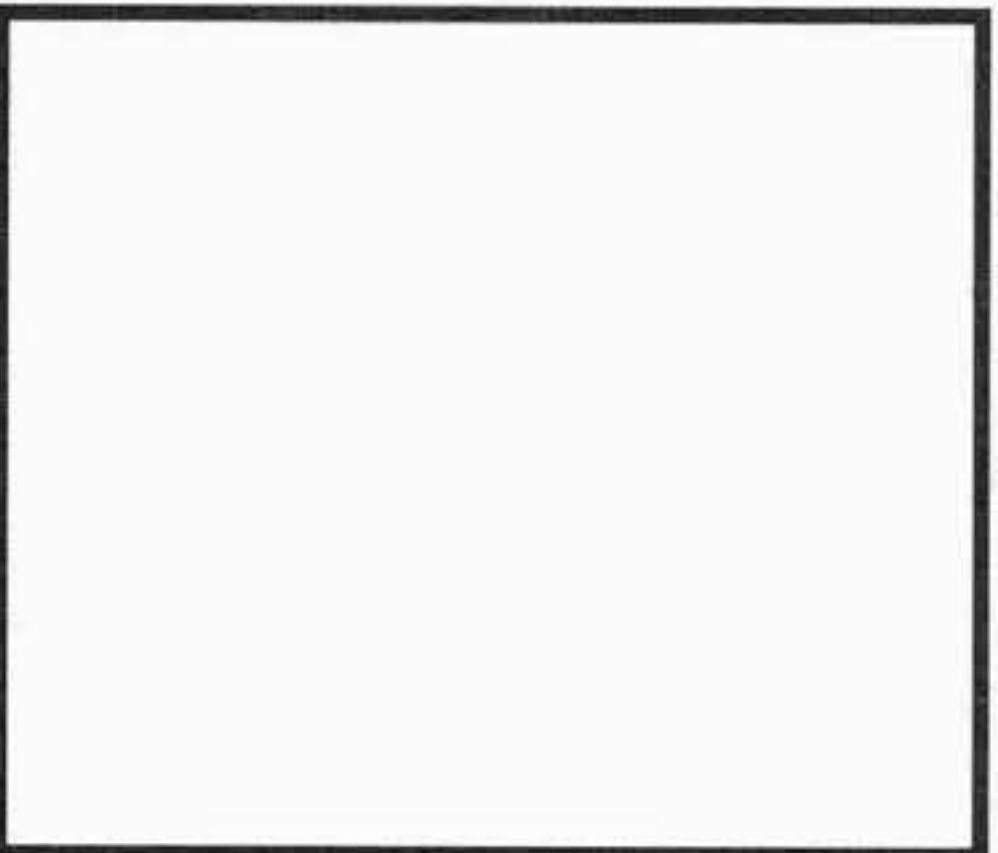
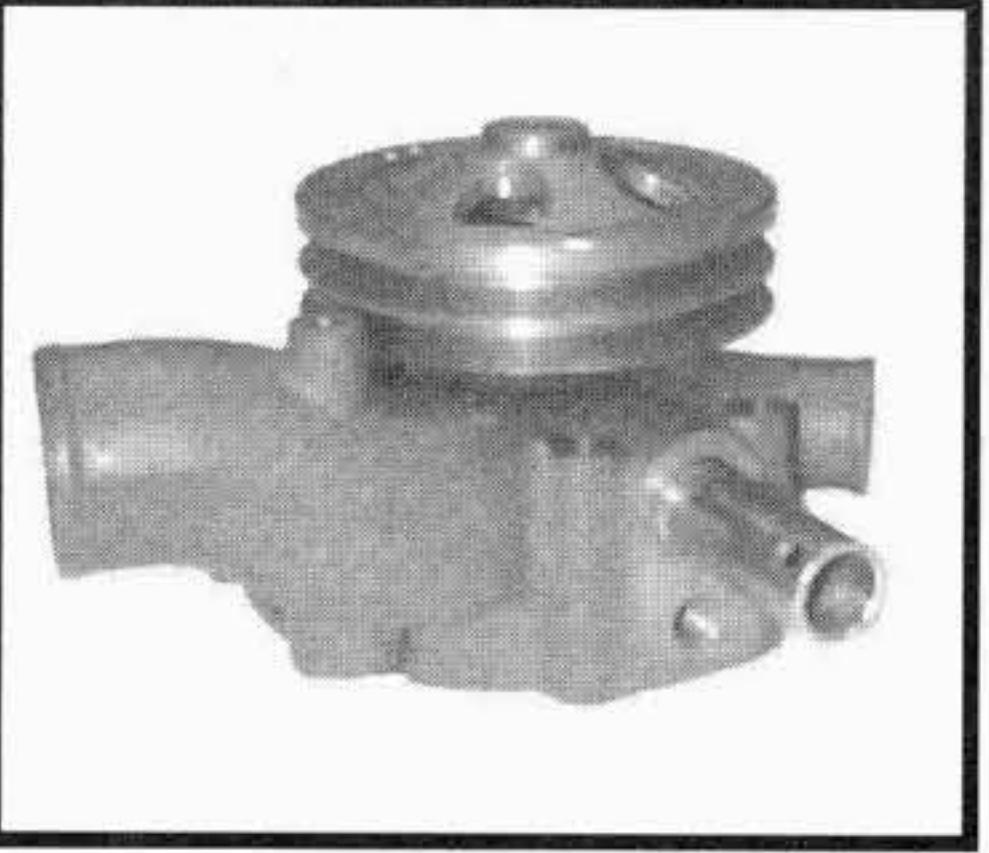
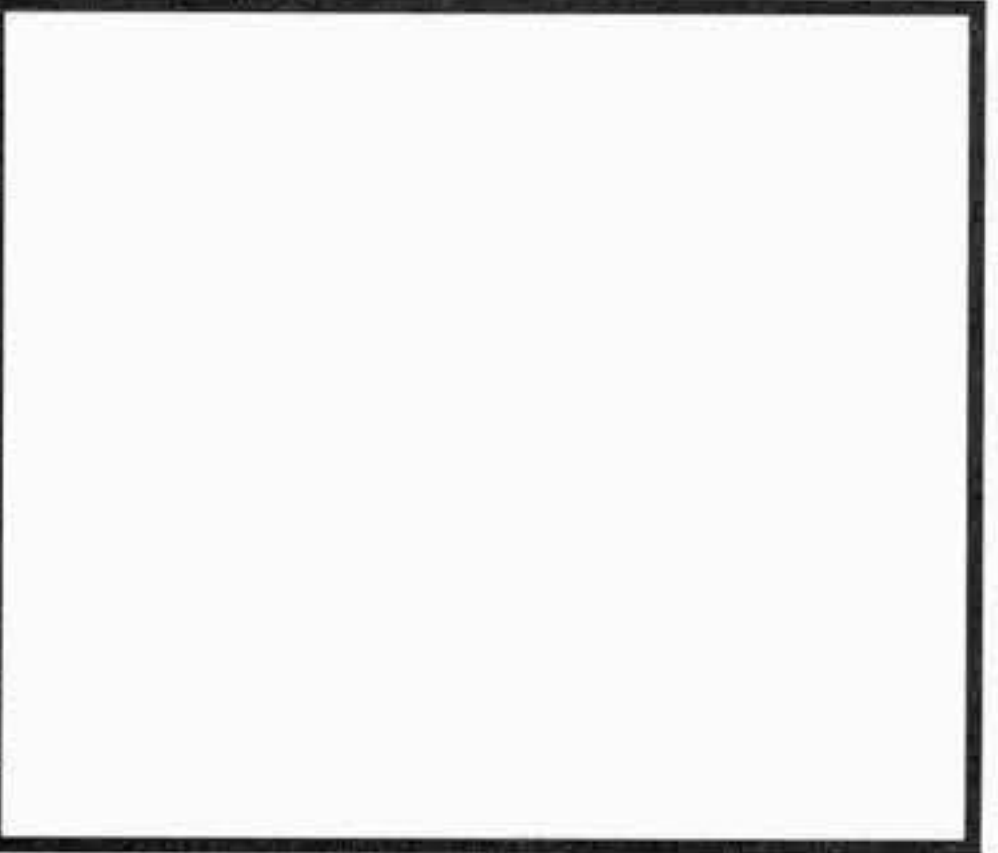
TIPO O MODELLO TYPE OU MODELE TYPE OR MODEL	MOTORE MOTEUR ENGINE	POMPA ACQUA POMPE A EAU WATER PUMP	KIT RIPARAZIONE NECESSAIRE DE REP. REPAIR KIT
60.11 - 65.12 - 79.12 79.14 - 95.14 - 109.14 <i>4 Serie</i> 95.14 109.14 110.14 P (4 X 4) 115.14 - 135.14 <i>1 e 2 Serie</i> 115.17 - 135.17 <i>1 e 2 Serie</i> 135.17 (VENEZUELA) 145.17 - 150.17 (CILE - ARGENTINA) 175.17	8040.25 8040.25 8060.04.669/.696 8060.04.689/.698 8060.04.676 8060.04.636/.637 8060.24.601/.607 8060.05.200 8060.25.600 8060.25	<p style="text-align: center;">196.342 98497115</p> 	<p style="text-align: center;">192.266 ---</p> 
<p>EUROCARGO</p> 65E12 - 65E14 - 75E12 75E14 - 75E15 - 80E15 80E18 - 80E21 - 85E15 85E18 - 85E21 - 100E15 100E18 - 100E21 120E15 - 120E18 130E15 - 130E18 - 130E21 92901167	8040.25 8040.45 4 cyl. 3908 cm ³ 116 - 136 cv 8060.25 8060.45 6 cyl. 5861 cm ³ 143 - 177 cv 207 cv	<p style="text-align: center;">196.650 98415831</p> 	<p style="text-align: center;">--- ---</p> 
120.14 140.14 150.14 150.17 159.17	8360.04 8360.04 8360.04 8360.05 8360.05	<p style="text-align: center;">196.170 4796527</p> 	<p style="text-align: center;">192.186 ---</p> 
130.20 140.20 159.20	8220.02.101	<p style="text-align: center;">196.330 61690371</p> 	<p style="text-align: center;">192.234 1902654</p> 

I ricambi non sono originali ma adattabili . Ogni riferimento originale é assolutamente indicativo .
 Spare parts are not original but perfectly suitable . Every original part number has to be considered for reference purpose only .

SUITABLE







IVECO

AUTOCARRI - CAMIONS - TRUCKS - LKW

Tel: +44(0)1925 850082 Fax: +(0)44 1925 850083

www.spwaterpumps.co.uk

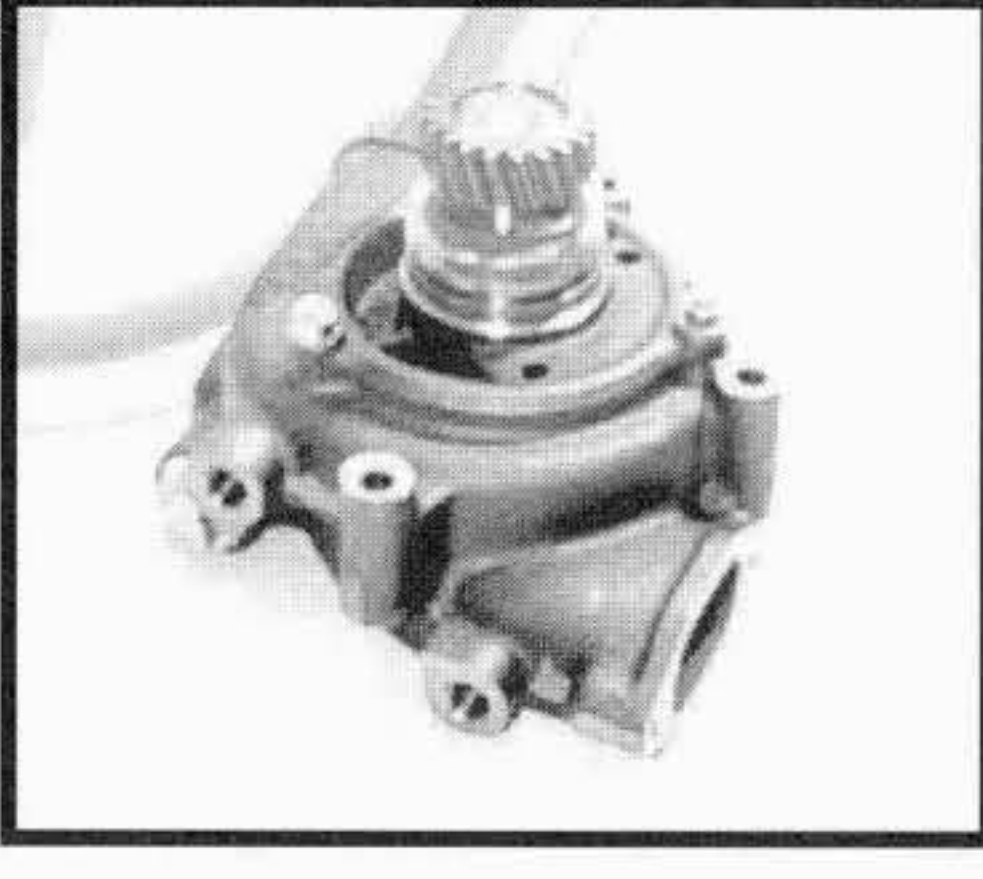

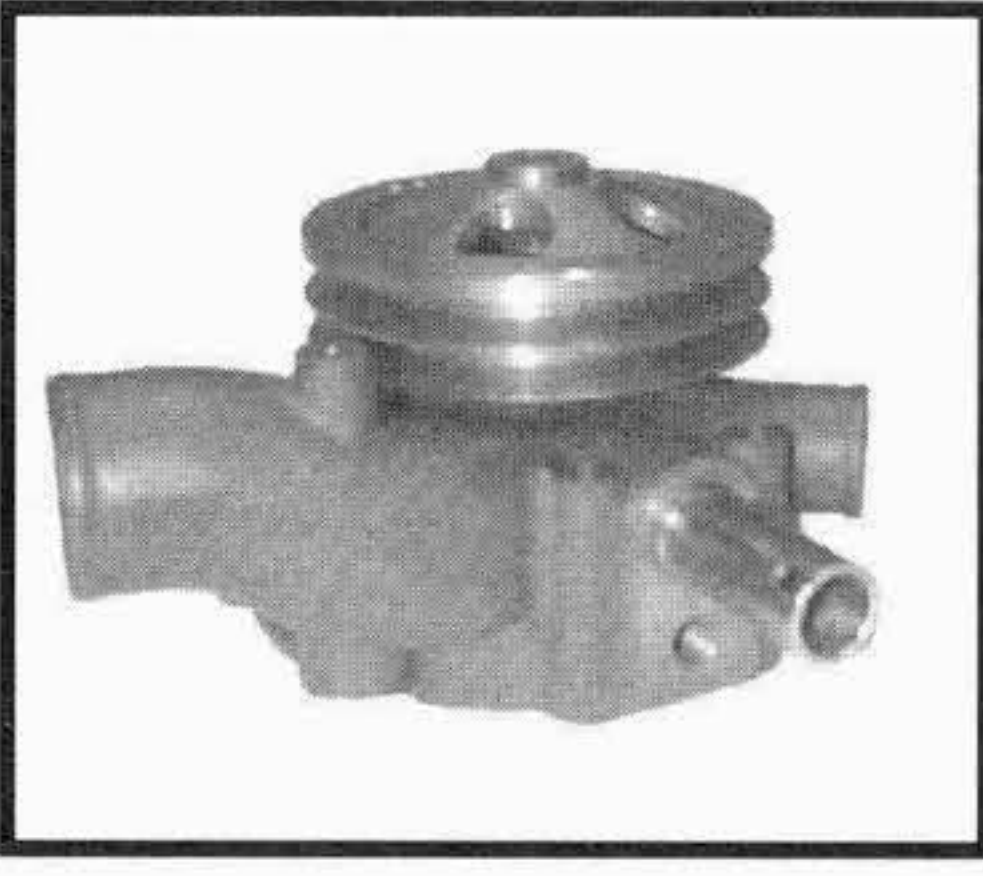
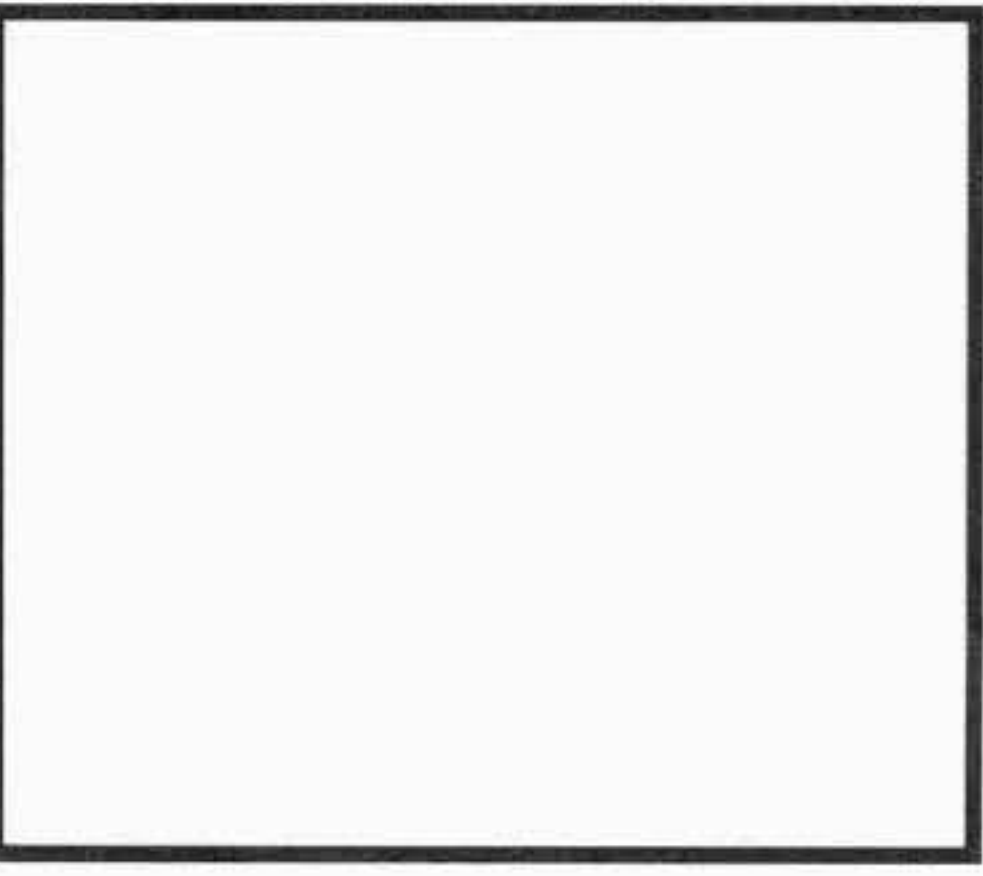
TIPO O MODELLO TYPE OU MODELE TYPE OR MODEL	MOTORE MOTEUR ENGINE	POMPA ACQUA POMPE A EAU WATER PUMP	KIT RIPARAZIONE NECESSAIRE DE REP. REPAIR KIT
		OMP REF. / O.EM. REF	OMP REF. / O.EM. REF
EUROCARGO 120E23 130E23 150E23 280E23 92901301	8060.45 6 cyl. 5891 cm ³ 227 CV	<p>196.445 4838676</p> 	<p>--- ---</p> 
EUROCARGO 120E27 150E27 R320E27 92901387	8360.46 6 cyl. 7685 cm ³ 266 CV	<p>216.278 98439476</p> 	<p>216.568 42532082</p> 
EUROTECH 180E27 190E27 With 14mm Water Filter Hole 92901154	8360.46 6 cyl. 7685 cm ³ 266 CV	<p>216.306 98479917</p> 	<p>216.568 42532082</p> 
165.24	8220.22.002/004 177/240	<p>196.300 61690377</p> 	<p>192.234 1902654</p> 

I ricambi non sono originali ma adattabili . Ogni riferimento originale é assolutamente indicativo .
 Spare parts are not original but perfectly suitable . Every original part number has to be considered for reference purpose only .

SUITABLE



IVECO

AUTOCARRI - CAMIONS - TRUCKS - LKW

Tel: +44(0)1925 850082 Fax: +(0)44 1925 850083

www.spwaterpumps.co.uk

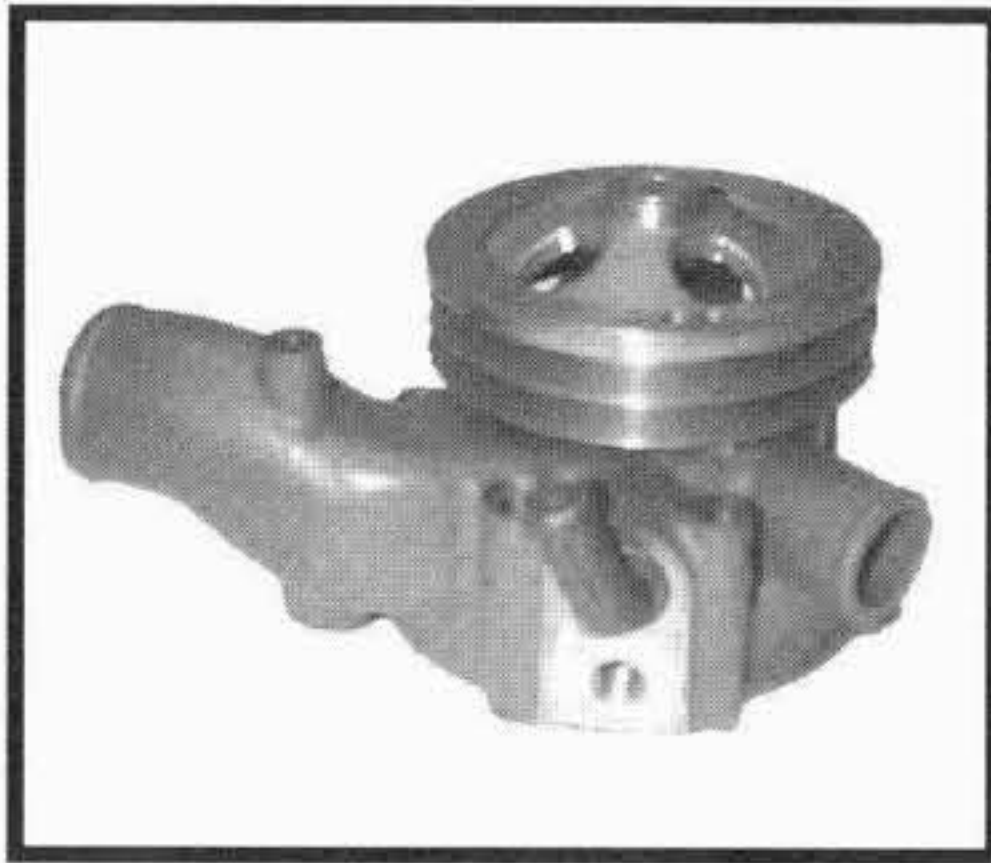
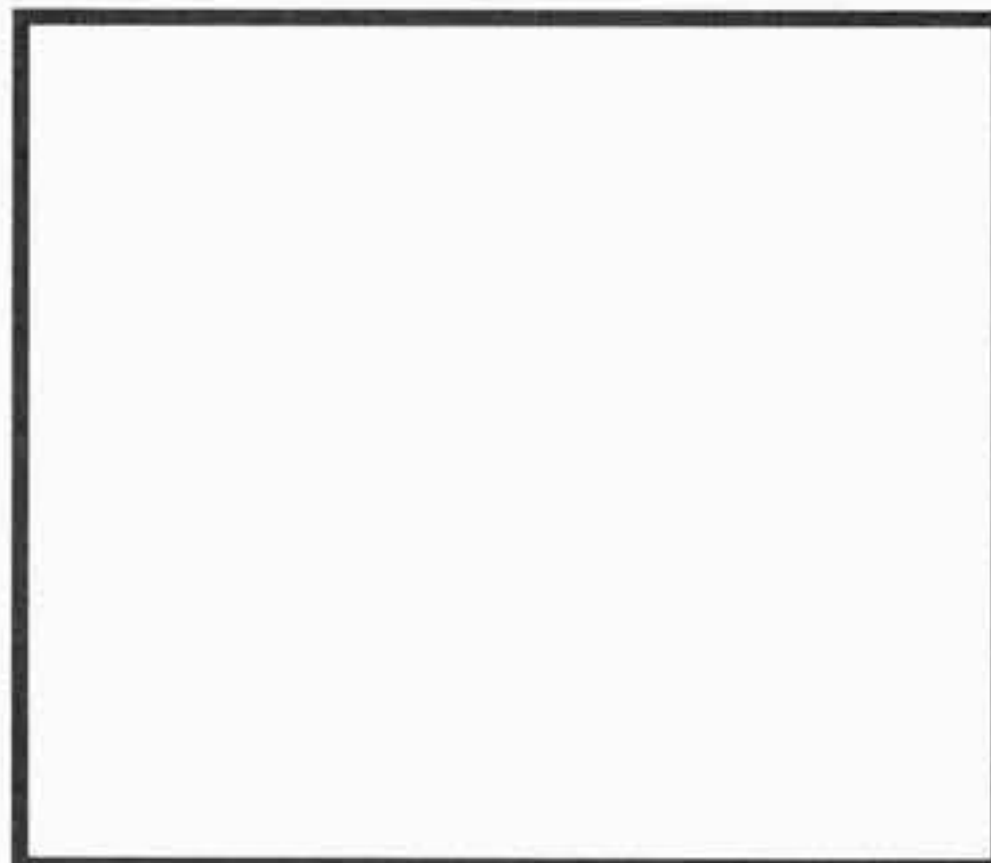
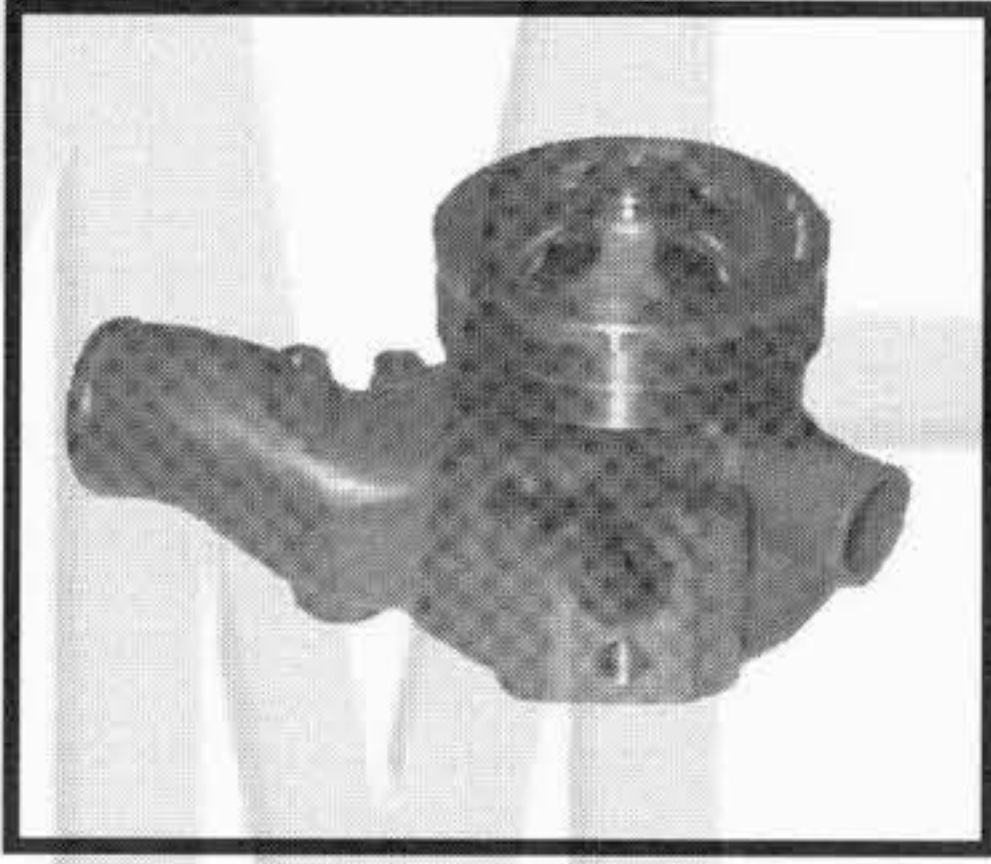
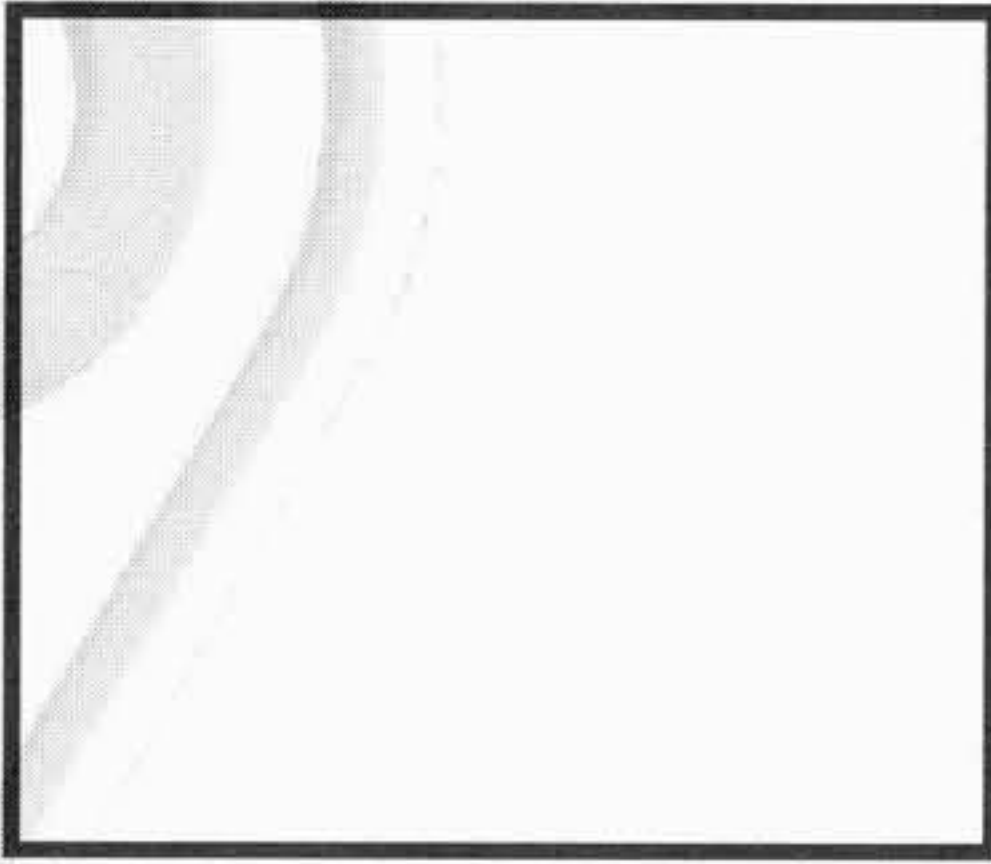

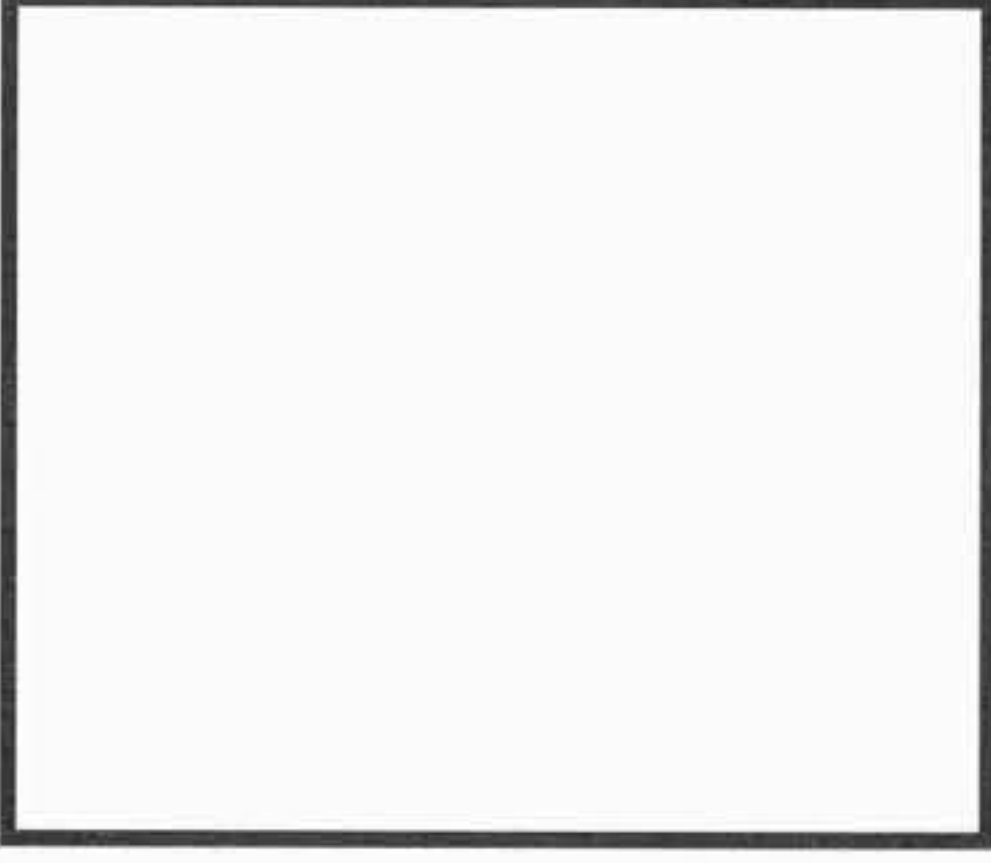
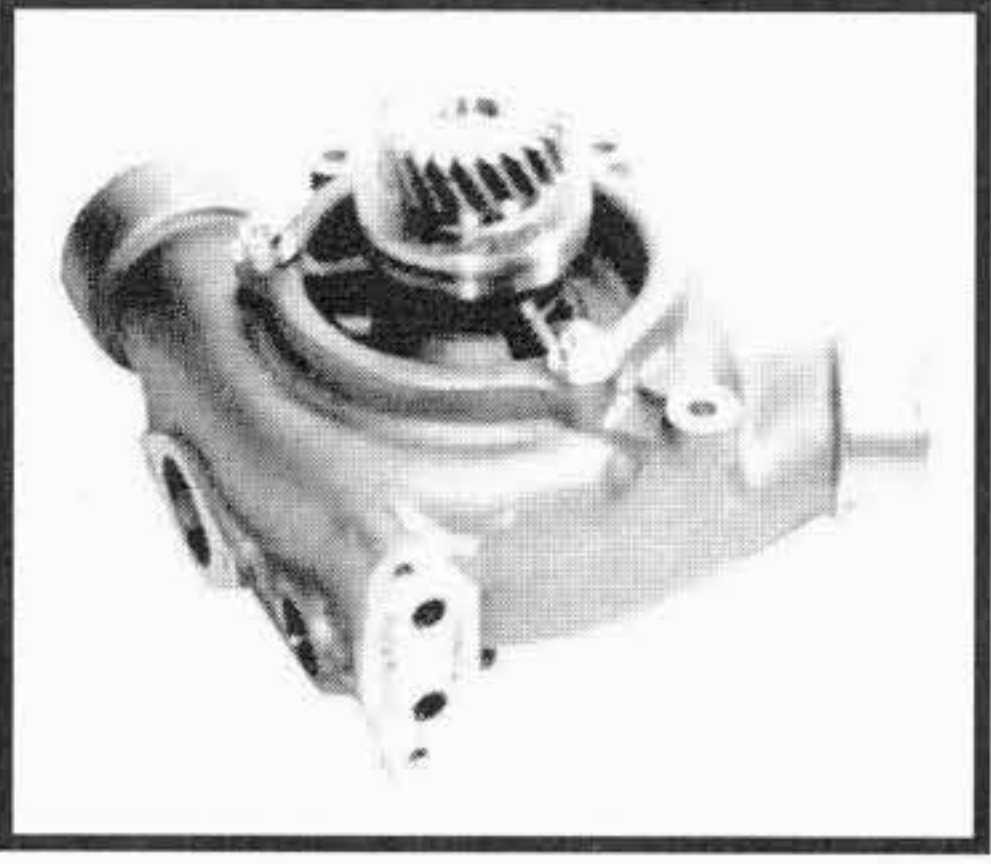
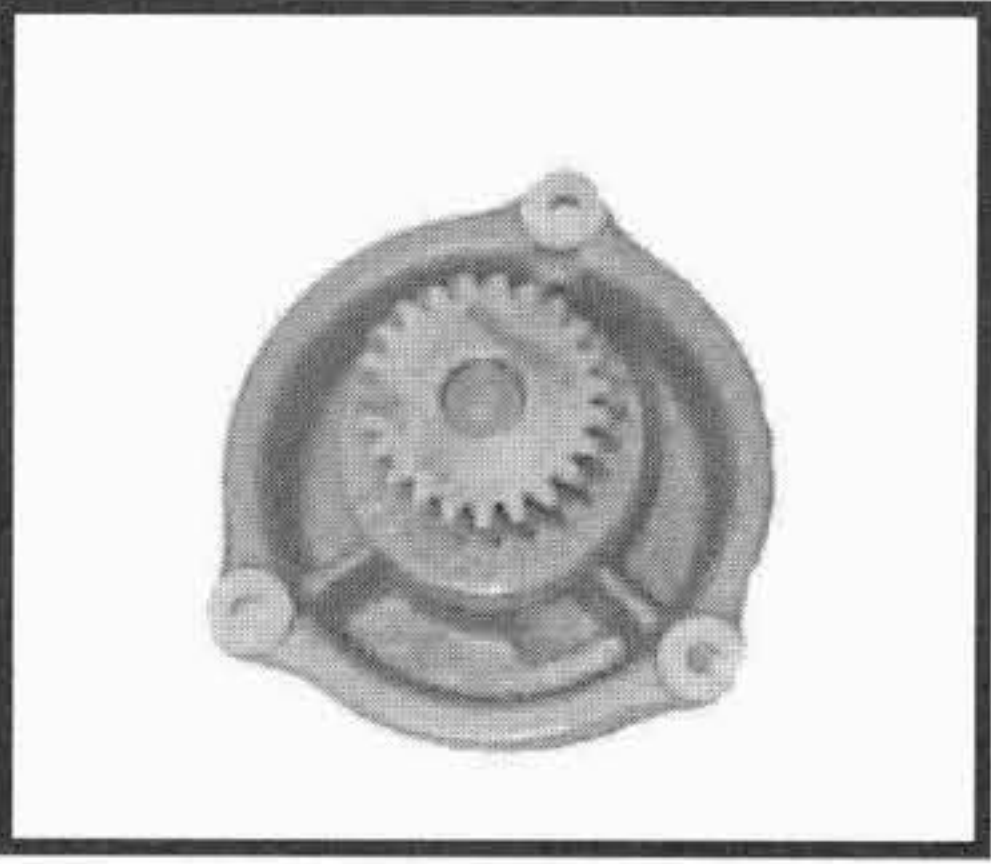
TIPO O MODELLO TYPE OU MODELE TYPE OR MODEL	MOTORE MOTEUR ENGINE	POMPA ACQUA POMPE A EAU WATER PUMP OMP REF. / O.EM. REF	KIT RIPARAZIONE NECESSAIRE DE REP. REPAIR KIT OMP REF. / O.EM. REF
170.20 190.20	8220.02.845/847 8220.02.845	196.340 61690374 	192.234 1902654 
180.24	8220.22.102/104	196.290 61690384 	192.234 1902654 
190 PAC 20 - 190.20 N	8220.02.815	196.350 61690369 	192.239 1902653 
175.24T./RSU/OTTIMIZZ. 190.24 TRU / TURBOTECH 190.26 TRU / TURBOTECH 190.32 TRU / TURBOTECH 220.32 TRU / TURBOTECH 240.26 TRU / TURBOTECH 240.32 TRU / TURBOTECH 260.32 TRU / TURBOTECH	8460.21 6 cyl. 9495 cm ³	196.450 61315464  INGRANAGGIO / GEAR	196.251 93190288  Ø = 62,5 mm N° denti = 23

I ricambi non sono originali ma adattabili . Ogni riferimento originale é assolutamente indicativo .
 Spare parts are not original but perfectly suitable . Every original part number has to be considered for reference purpose only .

SUITABLE







IVECO

AUTOCARRI - CAMIONS - TRUCKS - LKW

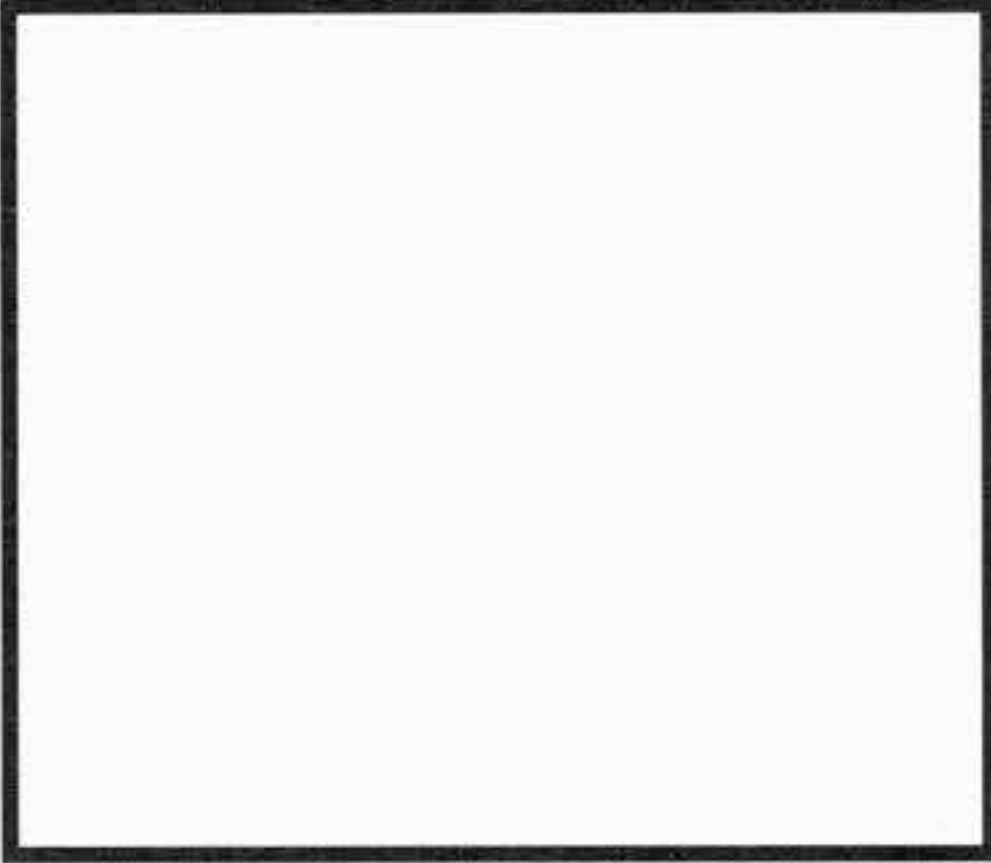
Tel: +44(0)1925 850082 Fax: +(0)44 1925 850083

www.spwaterpumps.co.uk

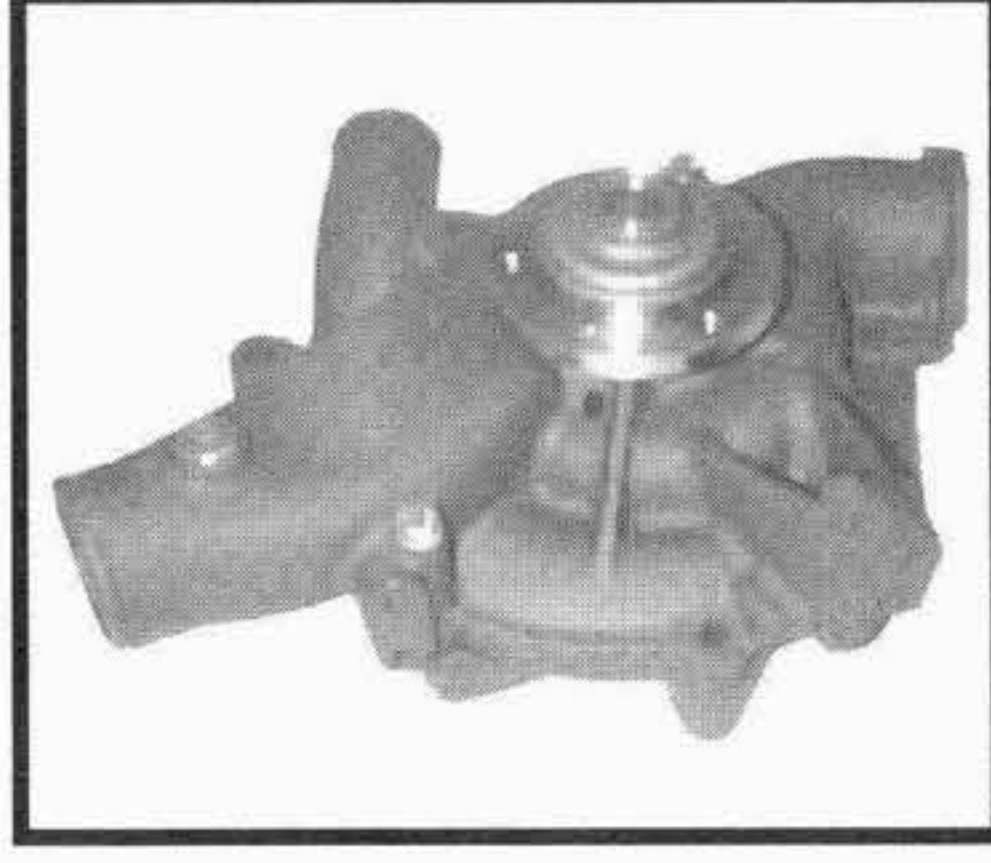

TIPO O MODELLO TYPE OU MODELE TYPE OR MODEL	MOTORE MOTEUR ENGINE	POMPA ACQUA POMPE A EAU WATER PUMP	OMP. REF. / O.EM. REF. KIT RIPARAZIONE NECESSAIRE DE REP. REPAIR KIT
160.26 170.26 180.26 190.26 190.30 190.33 - 190.33 TURBOSTAR 240.30	8210.02.673 8210.02.371/373 8210.02.373 6 cyl. 8210.02.317/373 8210.22.317/381 8210.22 243/330 8210.22.385/389	191.310 4710552 	192.019 1902655 
190 PC 26 - 190.26 H 190 PC 30 - 190.30 H 260 PC 26 - 260.26 H 330 PC 26 - 330.26 H 330.30 H	8210.02.269/731 8210.02.269 8210.22.235	196.070 4752137 	192.019 1902655 
190 PAC 26 - 190.26 N 260 PAC 26 - 260.26 N 260.26 NW 330 PAC 26 - 330.26 N	8210.02.269 8210.02.069 8210.02.069 8210.02.069	191.300 4606023 	192.013 1902659 
170.35 190.35 260 PC 35 - 260.35 H - 330.35 H 190.38 - 220.38 - 240.38 190.38 TURBOSTAR 190.42 - 190.42 TURBOSTAR	8280.02.109/121 8280.02.109/135 8280.02.269 8280.22.007/033 8280.22	196.015 4764156 	192.139 1902656 

I ricambi non sono originali ma adattabili . Ogni riferimento originale é assolutamente indicativo .



Spare parts are not original but perfectly suitable . Every original part number has to be considered for reference purpose only .

SUITABLE

IVECO

AUTOCARRI - CAMIONS - TRUCKS - LKW
Tel: +44(0)1925 850082 Fax: +(0)44 1925 850083
www.spwaterpumps.co.uk

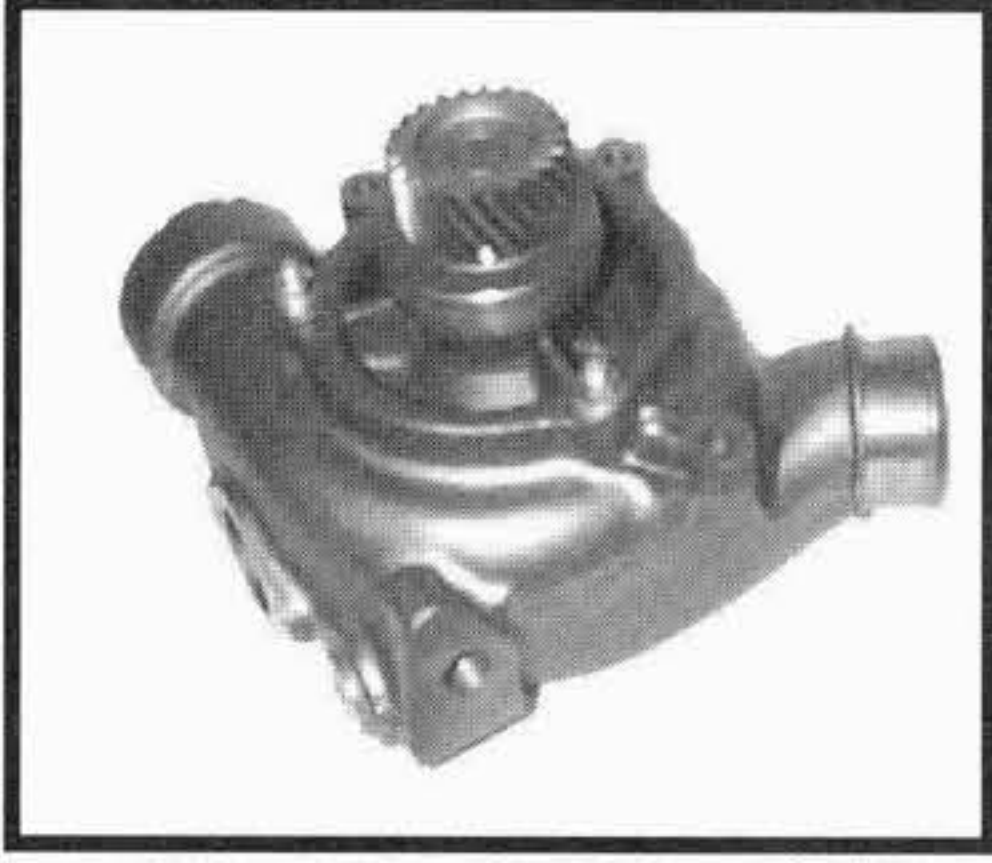
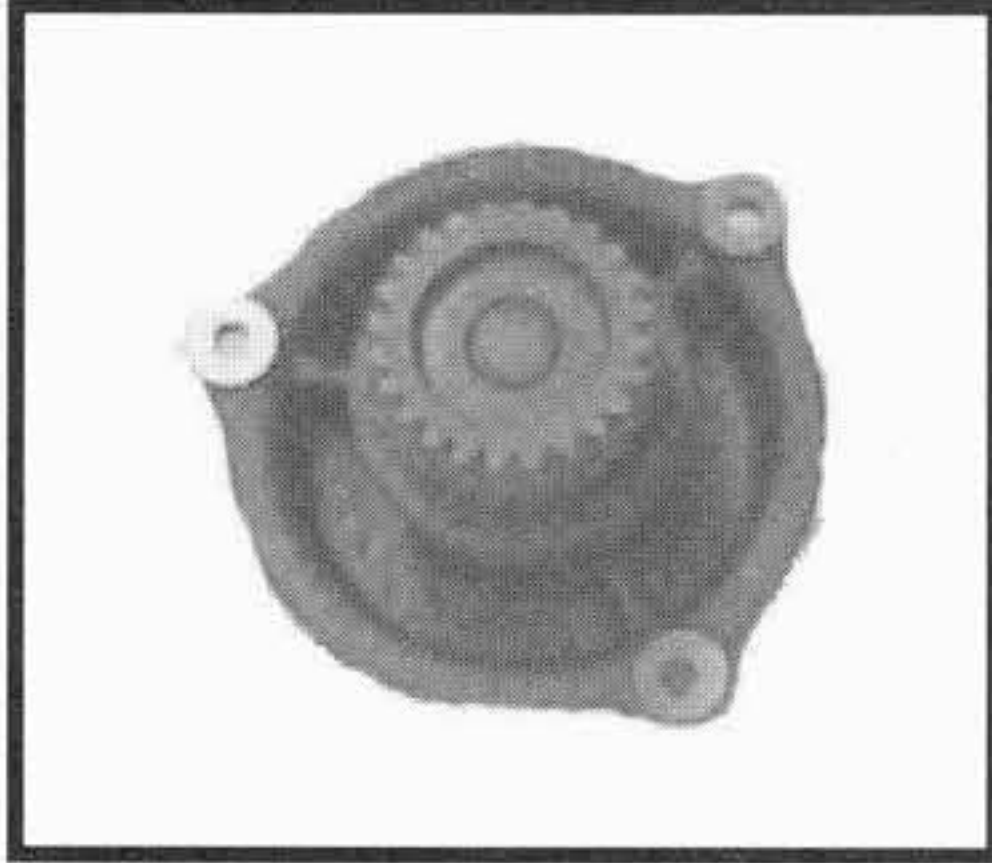
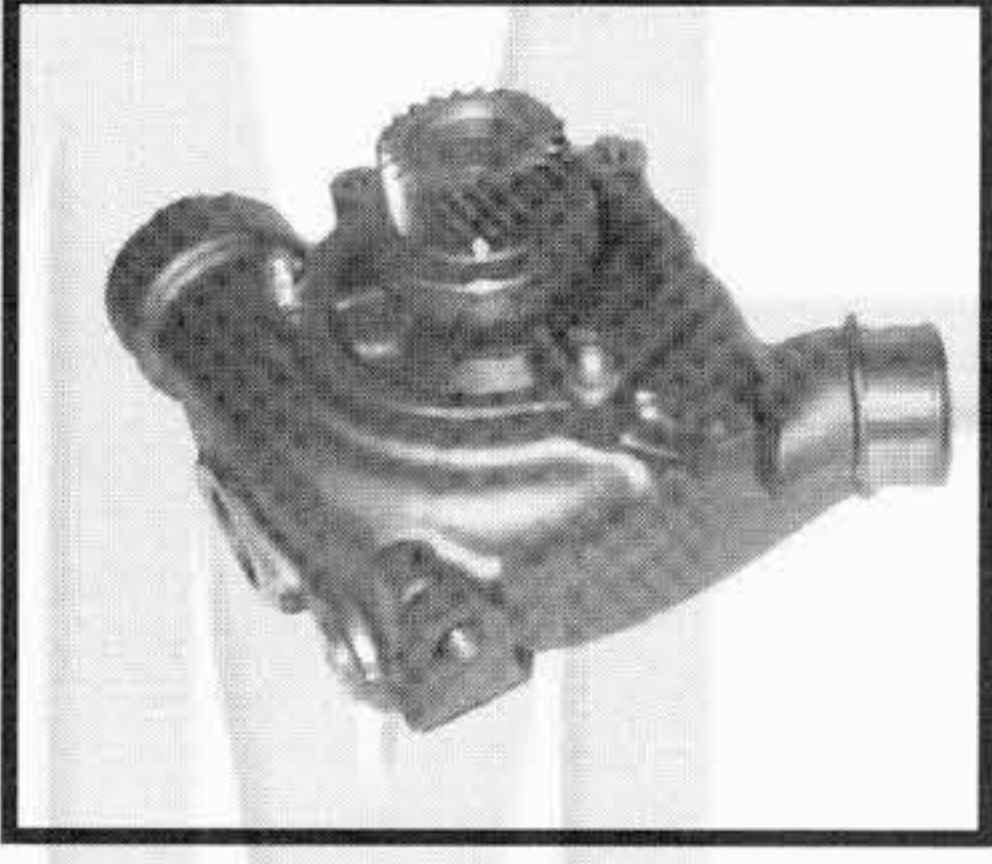
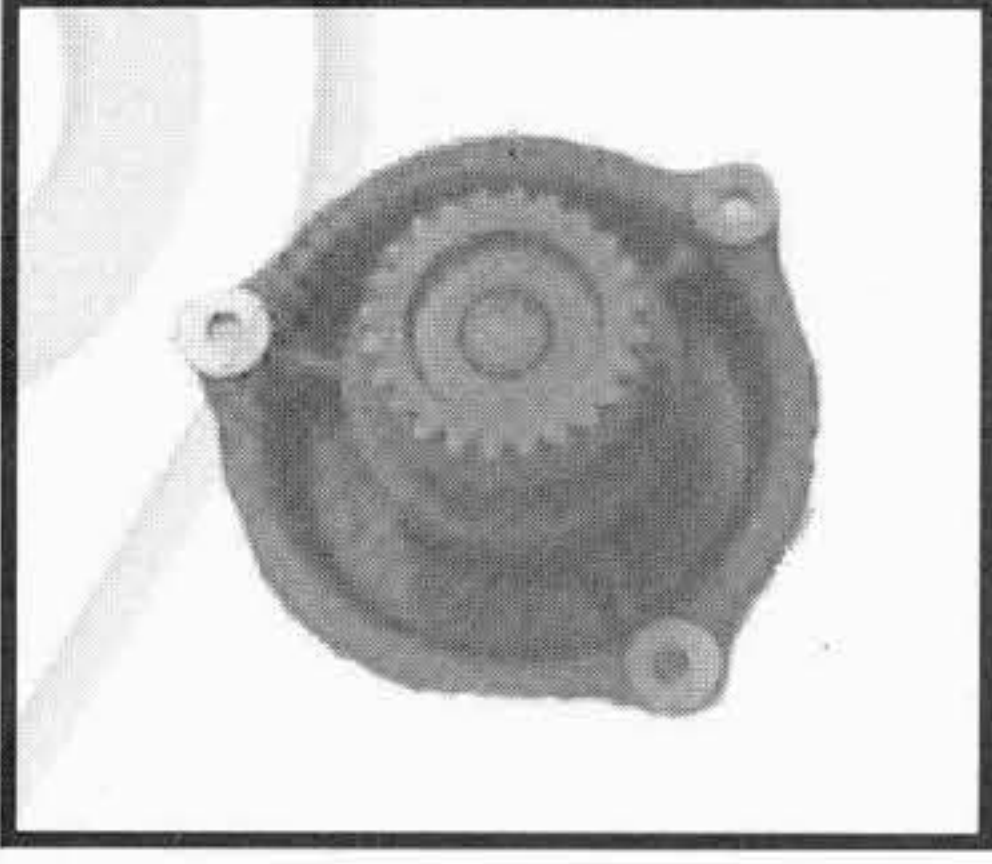

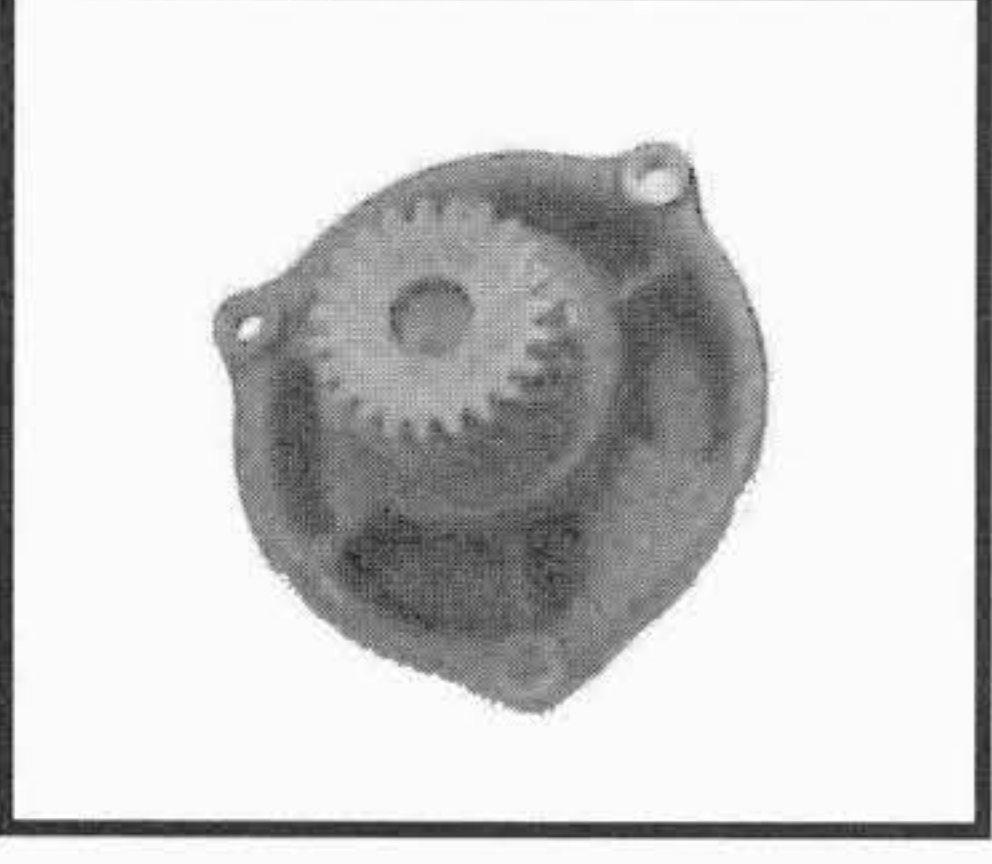
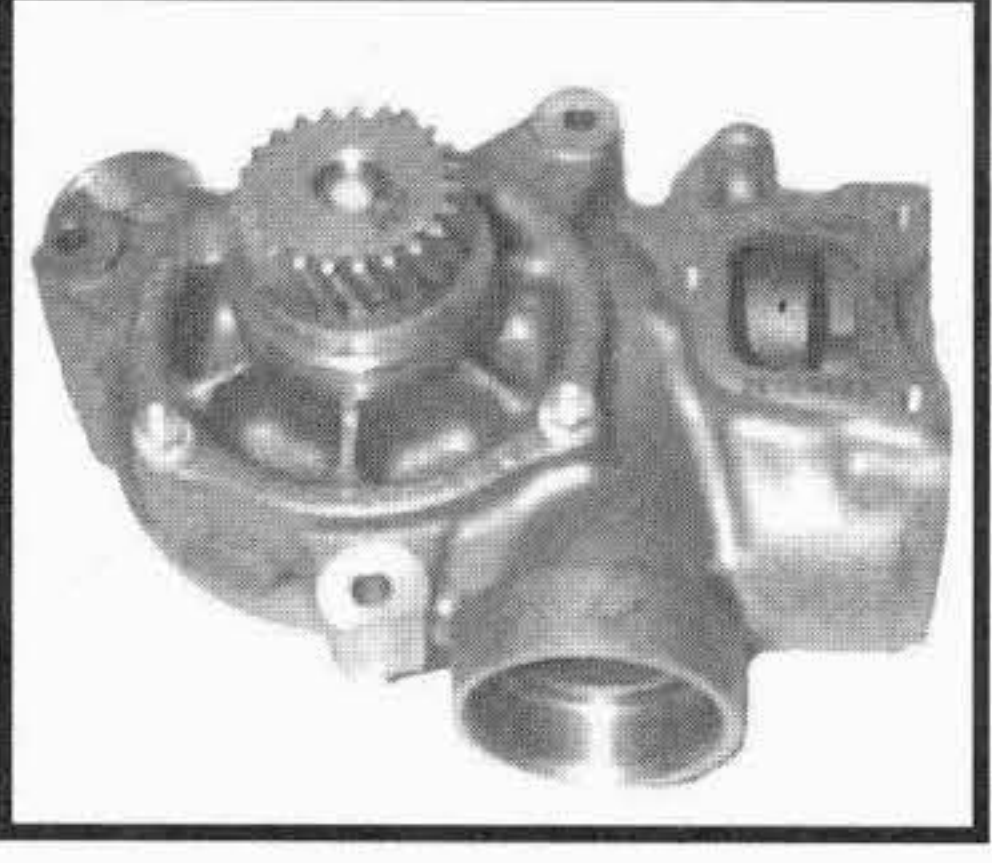
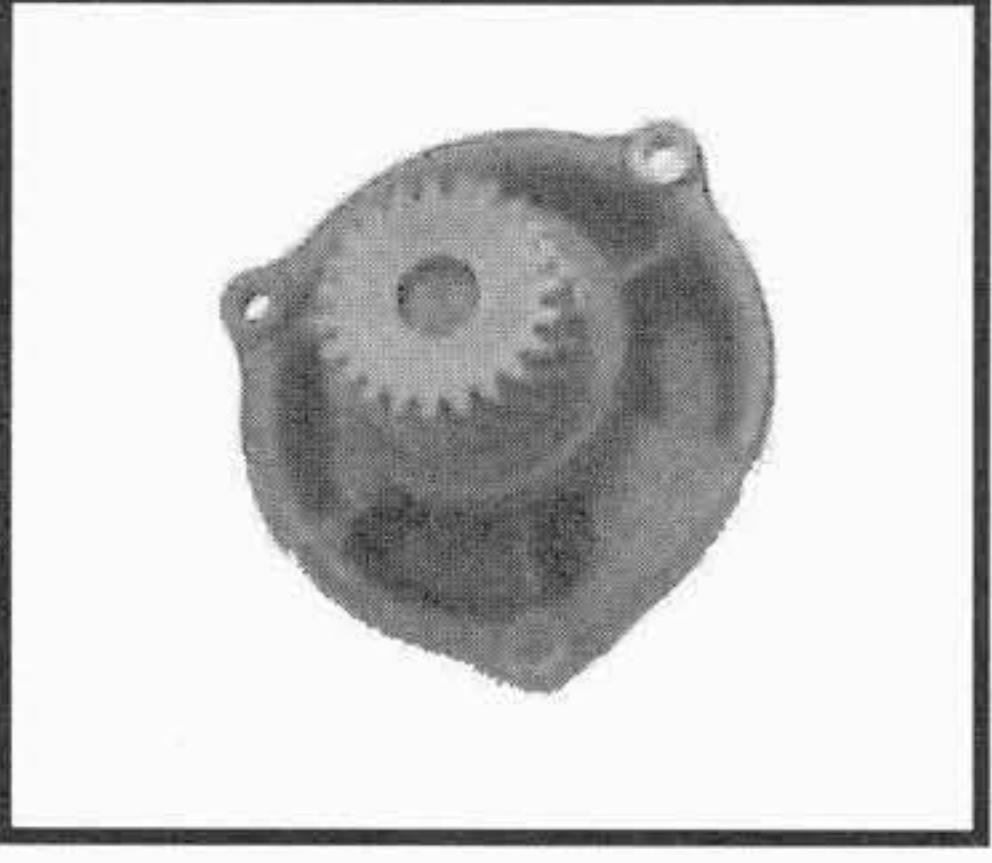
TIPO O MODELLO TYPE OU MODELE TYPE OR MODEL	MOTORE MOTEUR ENGINE	POMPA ACQUA POMPE A EAU WATER PUMP OMP REF. / O.EM. REF	KIT RIPARAZIONE NECESSAIRE DE REP. REPAIR KIT OMP REF. / O.EM. REF
190.36 TURBOTECH 190.36 TURBOSTAR 220.36 TRU 240.36 TRU 240.36 TURBOSTAR 260.36 TRU 260.36 TURBOSTAR 330.36 H / HT / HW	8210.42	196.436 99458098  INGRANAGGIO / GEAR	196.446 42530032  Ø = 63 mm N° denti = 24
190.36 TURBOTECH 190.36 TURBOSTAR E.S. 220.36 TRU TURBOTECH 240.36 TRU TURBOTECH 240.36 TURBOSTAR E.S. 260.36 TRU TURBOTECH 260.36 TURBOSTAR E.S.	8210.42 ECONOMY	196.438 99458099  INGRANAGGIO / GEAR	196.447 42530033  Ø = 65 mm N° denti = 19
EUROTECH 180E30 - 180E34 190E30 - 190E34 - 190E38 240E38 400E34 - 400E38 440E34 EUROTRAKKER 190E34 H 380E34 H	8460.SPR 6 cyl. 9500 cm ³ ----> ' 95	196.475 61318939  INGRANAGGIO / GEAR	196.293 93190284  Ø = 62,5 mm N° denti = 23
EUROTECH 180E30 - 180E34 190E30 - 190E34 - 190E38 240E38 400E34 - 400E38 440E34 EUROTRAKKER 190E34 H 380E34 H	8460.SPR 6 cyl. 9500 cm ³ ' 96 --->	196.434 61321400  INGRANAGGIO / GEAR	196.293 93190284  Ø = 62,5 mm N° denti = 23

I ricambi non sono originali ma adattabili . Ogni riferimento originale é assolutamente indicativo .
 Spare parts are not original but perfectly suitable . Every original part number has to be considered for reference purpose only .

SUITABLE



IVECO

AUTOCARRI - CAMIONS - TRUCKS - LKW

Tel: +44(0)1925 850082 Fax: +(0)44 1925 850083

www.spwaterpumps.co.uk

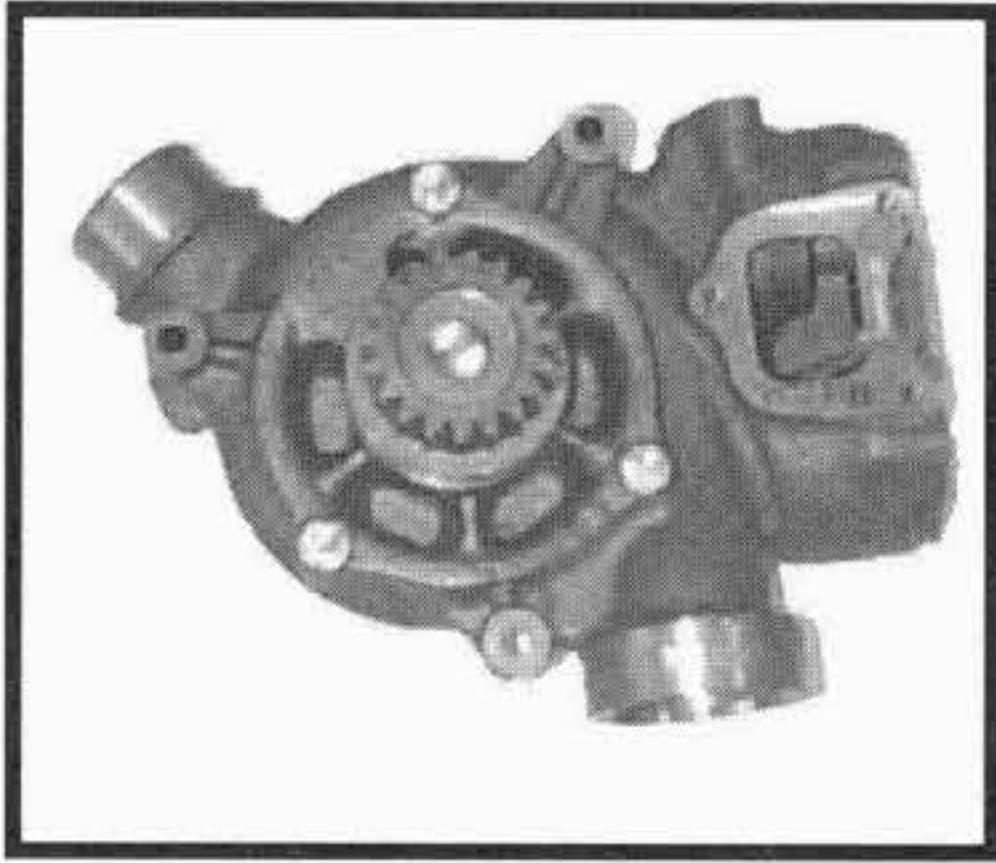
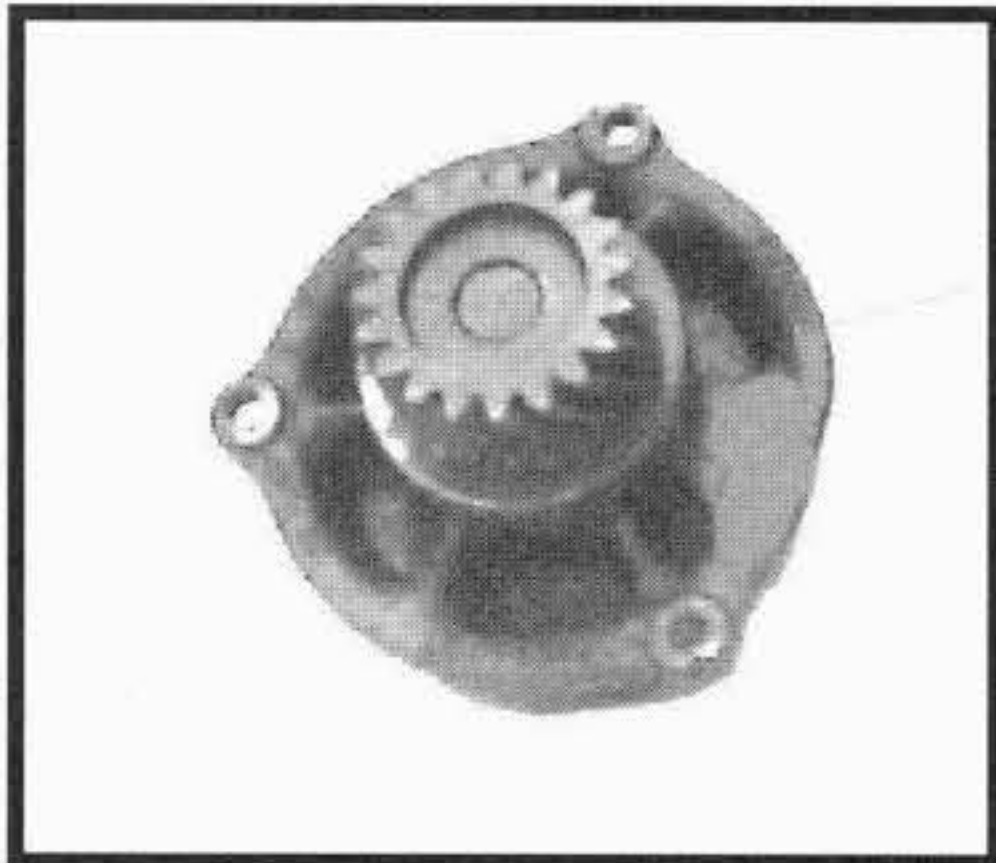
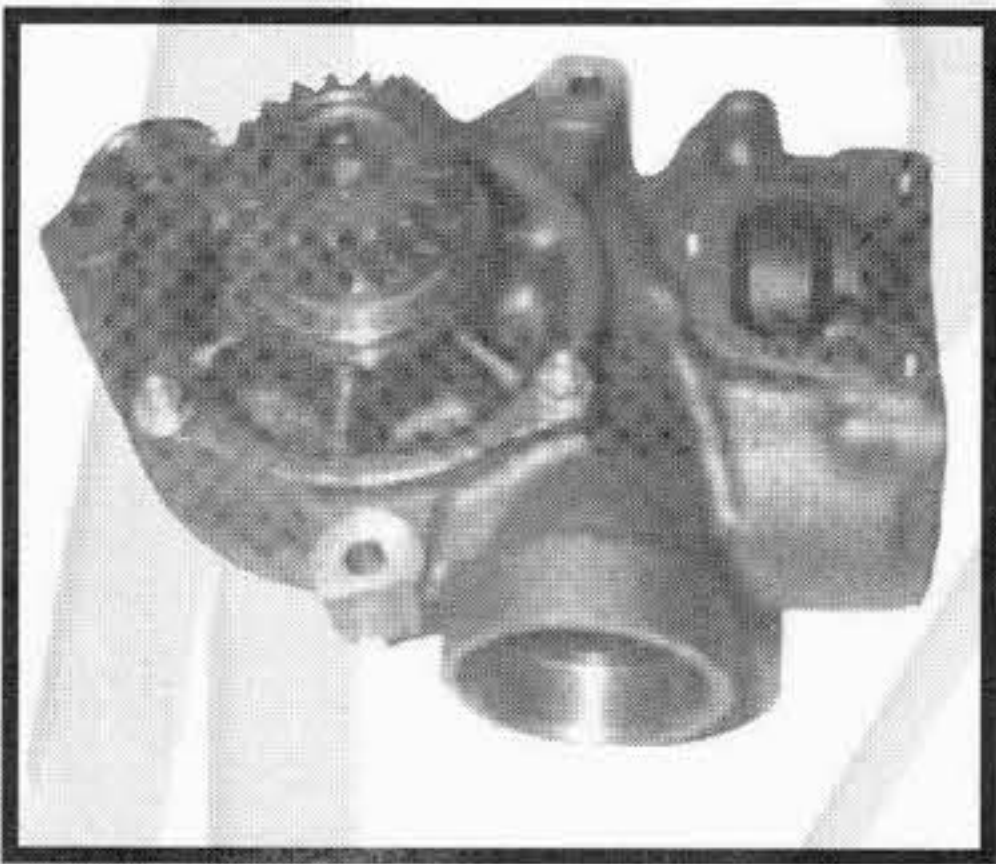
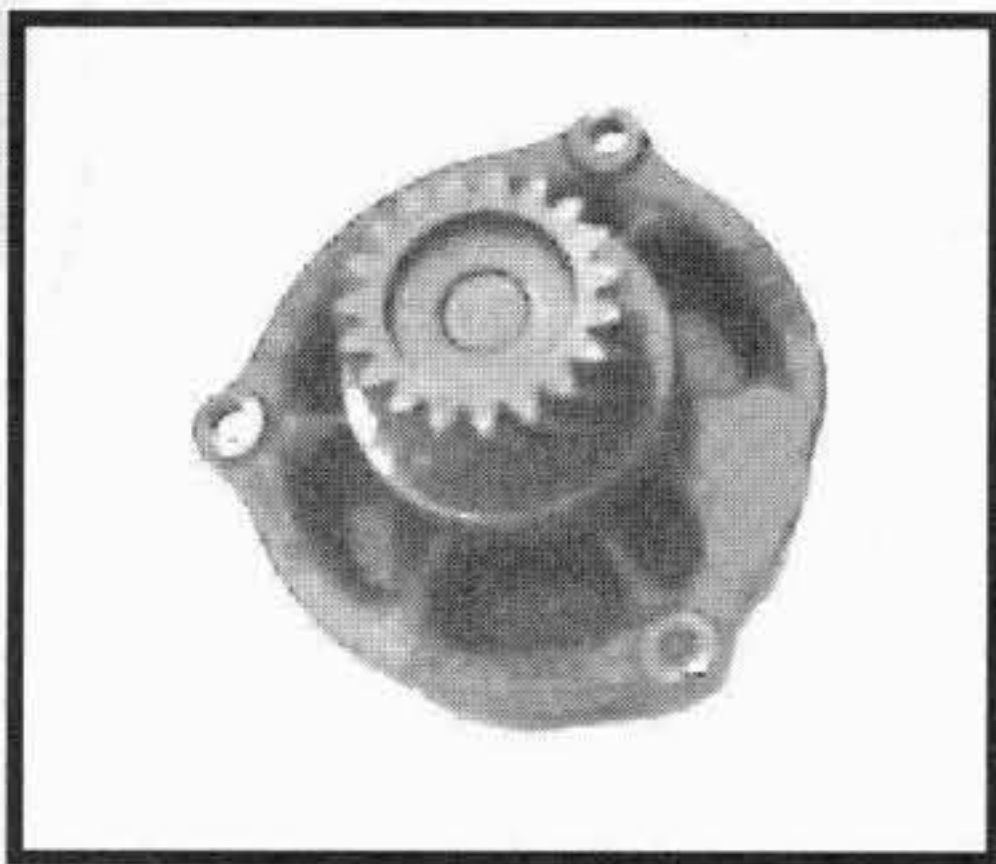
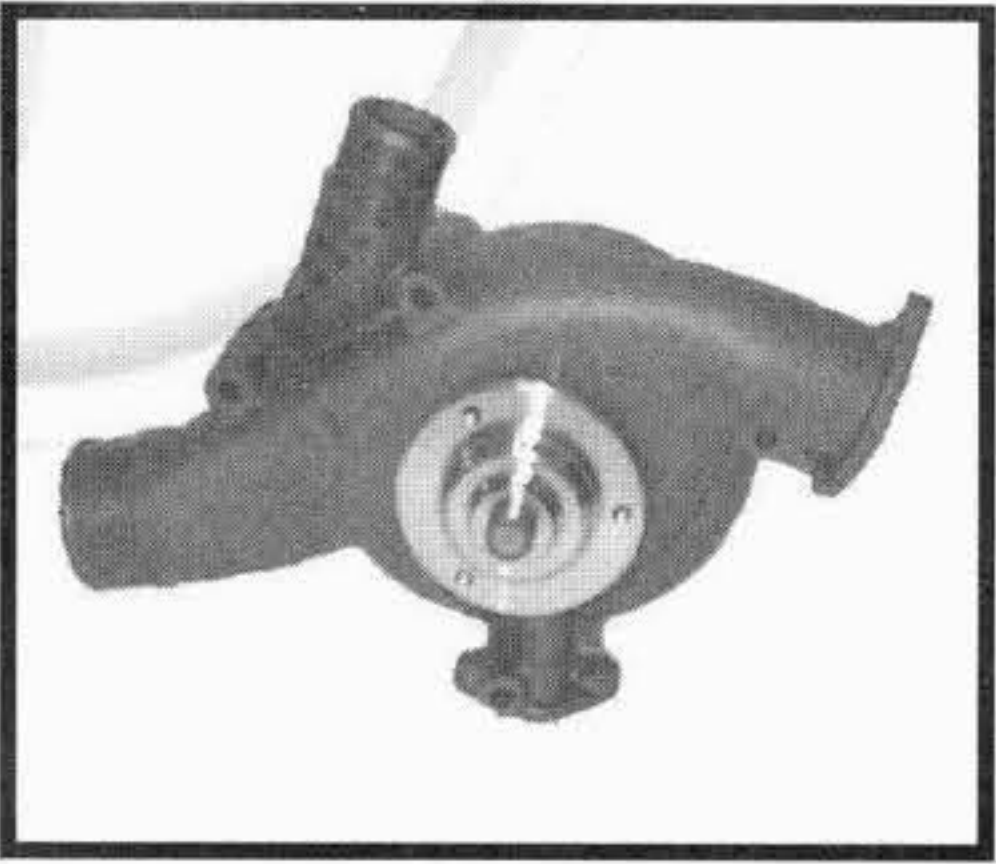
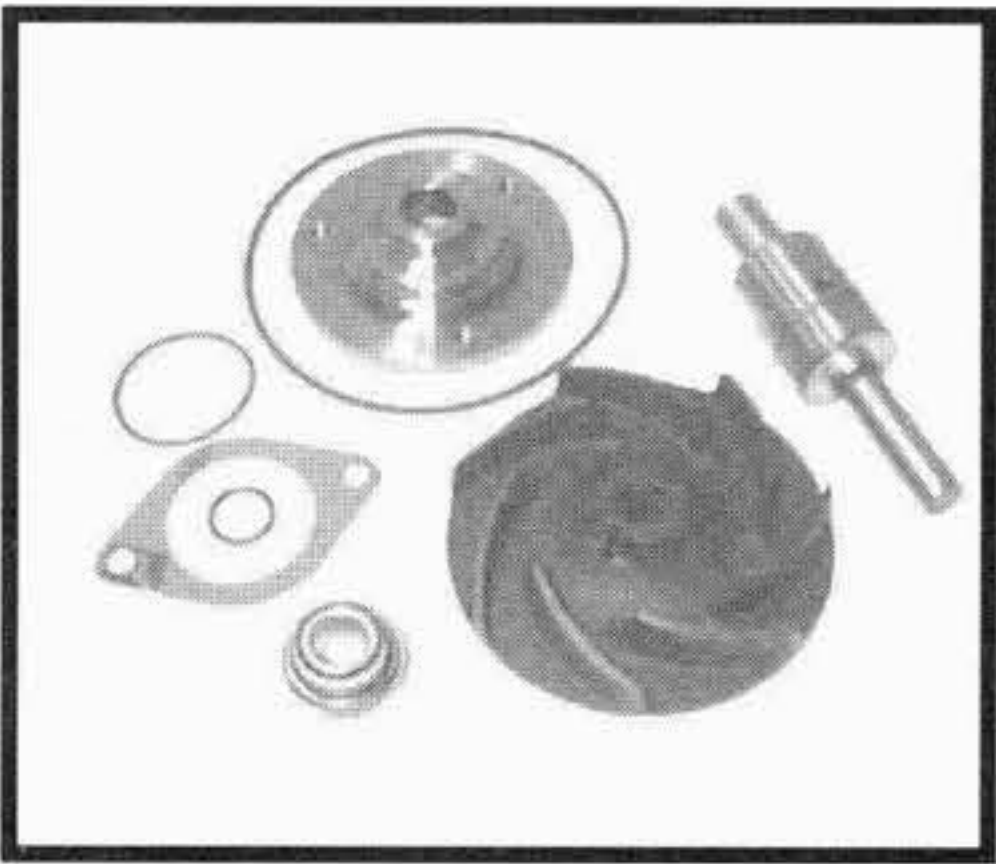
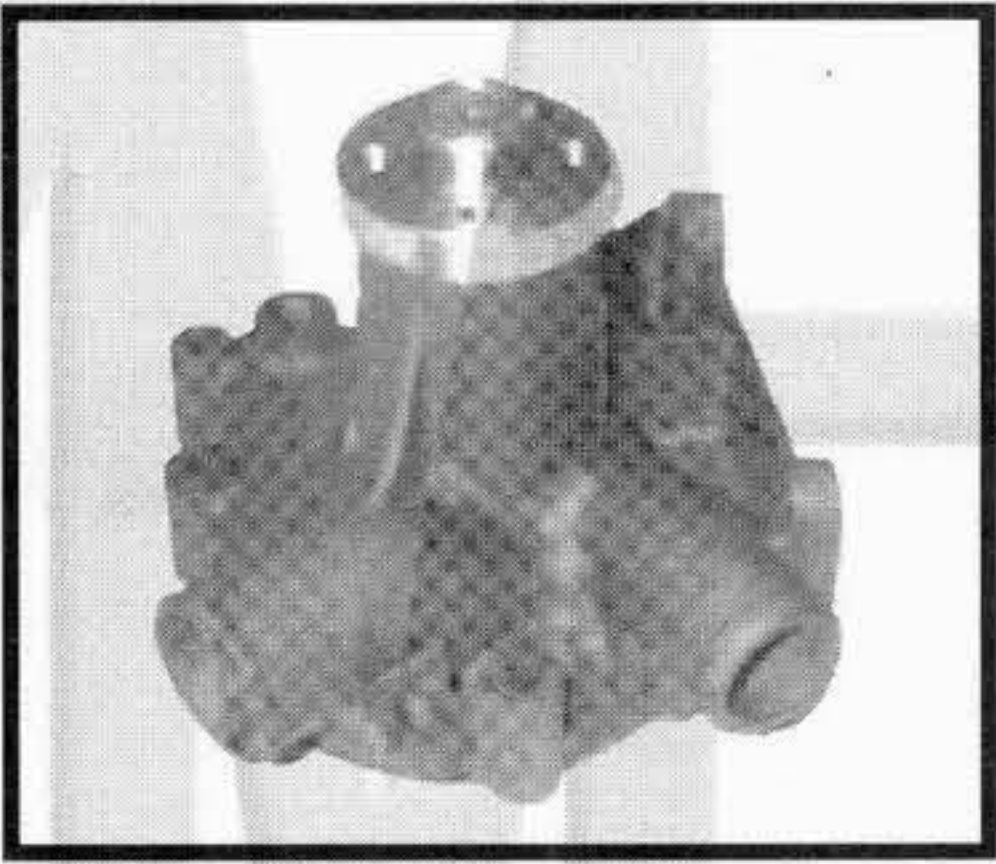

TIPO O MODELLO TYPE OU MODELE TYPE OR MODEL	MOTORE MOTEUR ENGINE	POMPA ACQUA POMPE A EAU WATER PUMP	KIT RIPARAZIONE NECESSAIRE DE REP. REPAIR KIT
<p>EUROTECH</p> <p>180E42 - 190E42 - 240E42 260E42 - 400E42 - 440E42</p> <p>EUROTRAKKER</p> <p>190E37 H - 380E37 H / W 410E37 H - 720E37 HT 380E42H/W - 410E42H - 720E42HT</p> <p>EUROSTAR</p> <p>190E42 - 240E42 - 440E42</p>	<p>8210.42L SPR</p> <p>----> '95</p> <p>8210.42K</p> <p>8210.42L</p> <p>8210.42L SPR</p> <p>----> '95</p>	<p>196.485 98447661</p>  <p>INGRANAGGIO / GEAR</p>	<p>216.419 99445447</p>  <p>Ø = 65 mm N° denti = 19</p>
<p>EUROTECH</p> <p>180E42 - 190E42 - 240E42 260E42 - 400E42 - 440E42 440E47</p> <p>EUROTRAKKER</p> <p>190E37 H - 380E37 H / W 410E37 H - 720E37 HT 380E42H/W - 410E42H - 720E42HT</p> <p>EUROSTAR</p> <p>190E42 - 190E47 240E42 - 240E47 440E42 - 440E47</p>	<p>8210.42L SPR</p> <p>'96 ----></p> <p>8210.42S.5000</p> <p>8210.42K</p> <p>8210.42L</p> <p>8210.42L SPR</p> <p>'96 ----></p> <p>8210.42S.5000</p>	<p>196.432 99453848</p>  <p>INGRANAGGIO / GEAR</p>	<p>216.419 99445447</p>  <p>Ø = 65 mm N° denti = 19</p>
<p>TURBOSTAR</p> <p>190.48 - 220.48</p> <p>240.48 - 260.48</p> <p>EUROSTAR</p> <p>190E52</p> <p>240E52</p> <p>440E52</p>	<p>8280.42</p> <p>8280.42S</p>	<p>196.347 500300470</p> 	<p>192.251 1904768</p> 
	<p>8361 i 000</p> <p>8361 i 001</p> <p>8361 si 10</p> <p>8361 si 10</p> <p>8361 si 11</p> <p>8361 sri 10</p> <p>8361 sri 15</p>	<p>206.200 4796537</p> 	<p>202.206 ---</p> 

I ricambi non sono originali ma adattabili . Ogni riferimento originale é assolutamente indicativo .
Spare parts are not original but perfectly suitable . Every original part number has to be considered for reference purpose only .

SUITABLE

IVECO





FIAT - OM - UNIC

AUTOBUS - AUTOCARS - BUSES

Tel: +44(0)1925 850082 Fax: +(0)44 1925 850083

www.spwaterpumps.co.uk

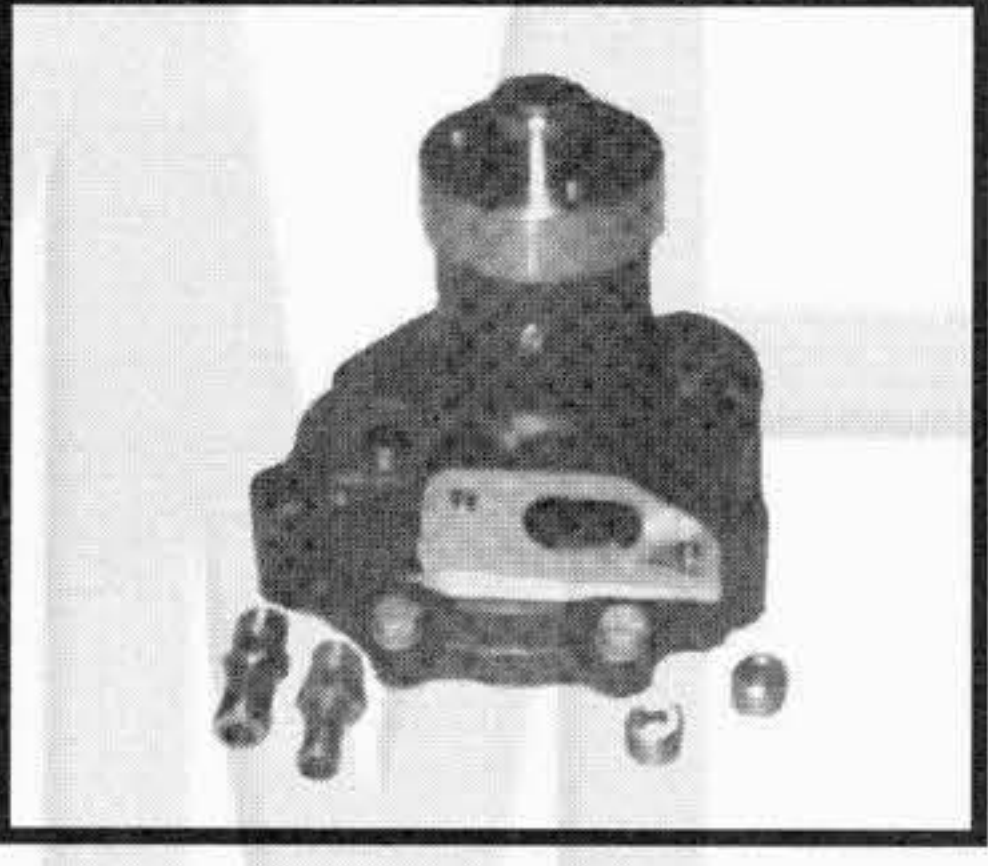
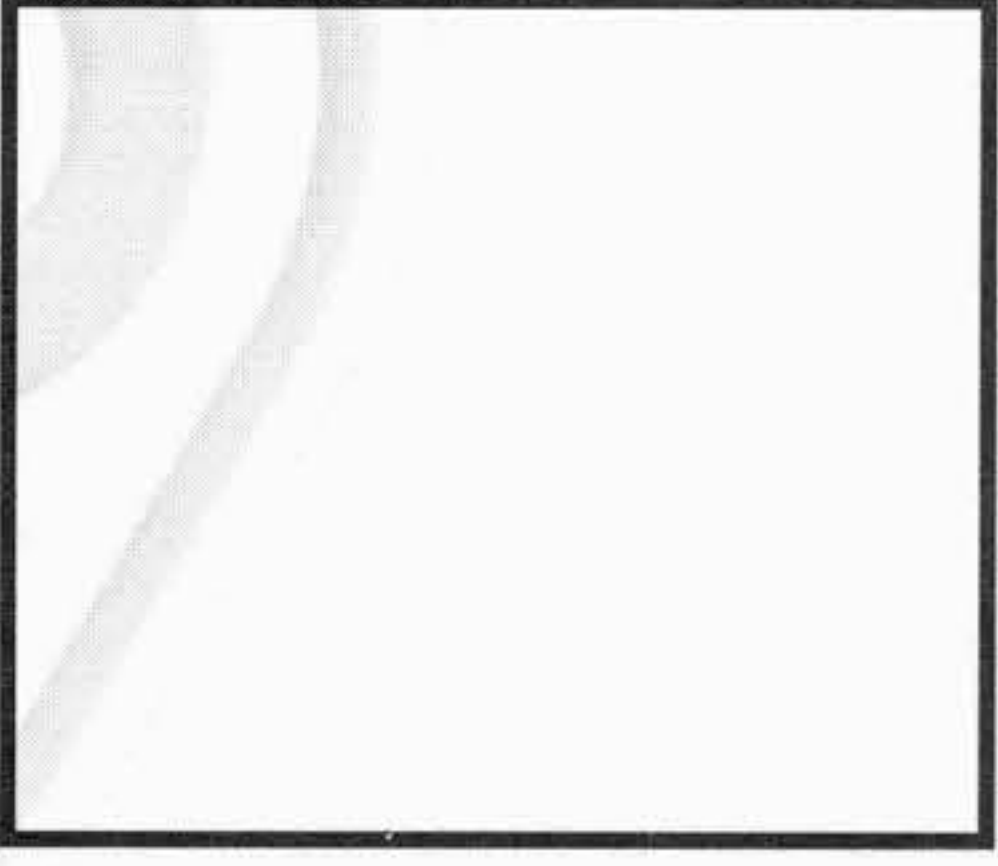

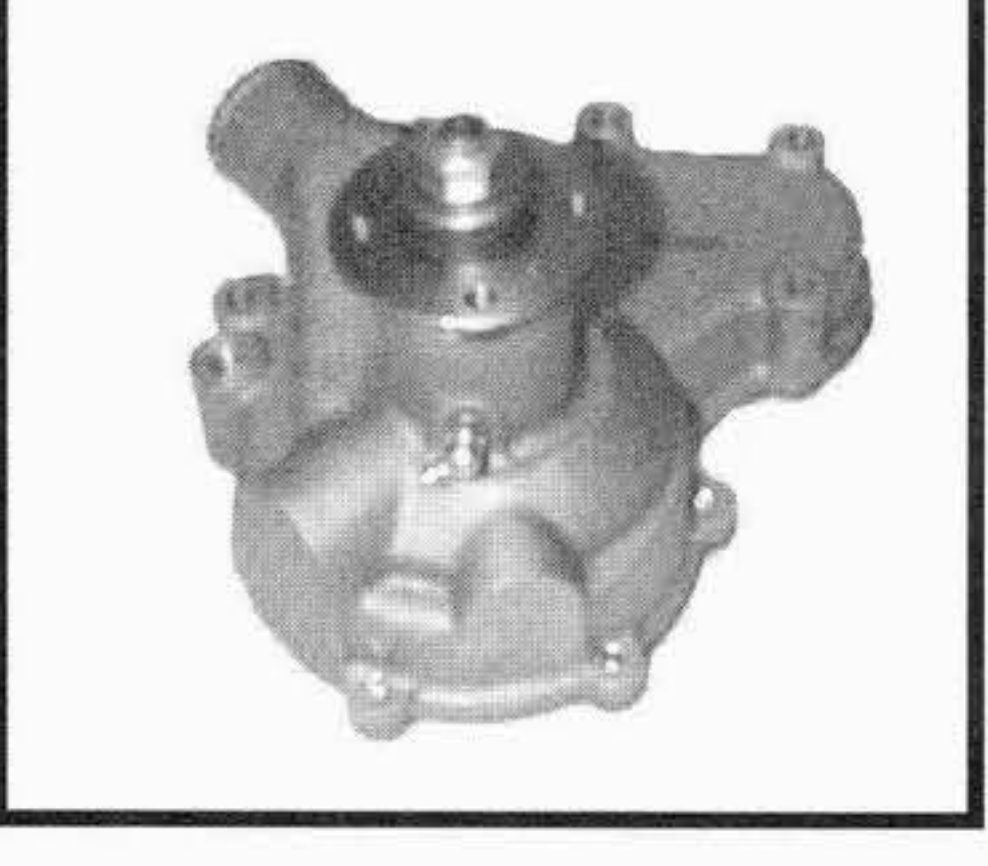
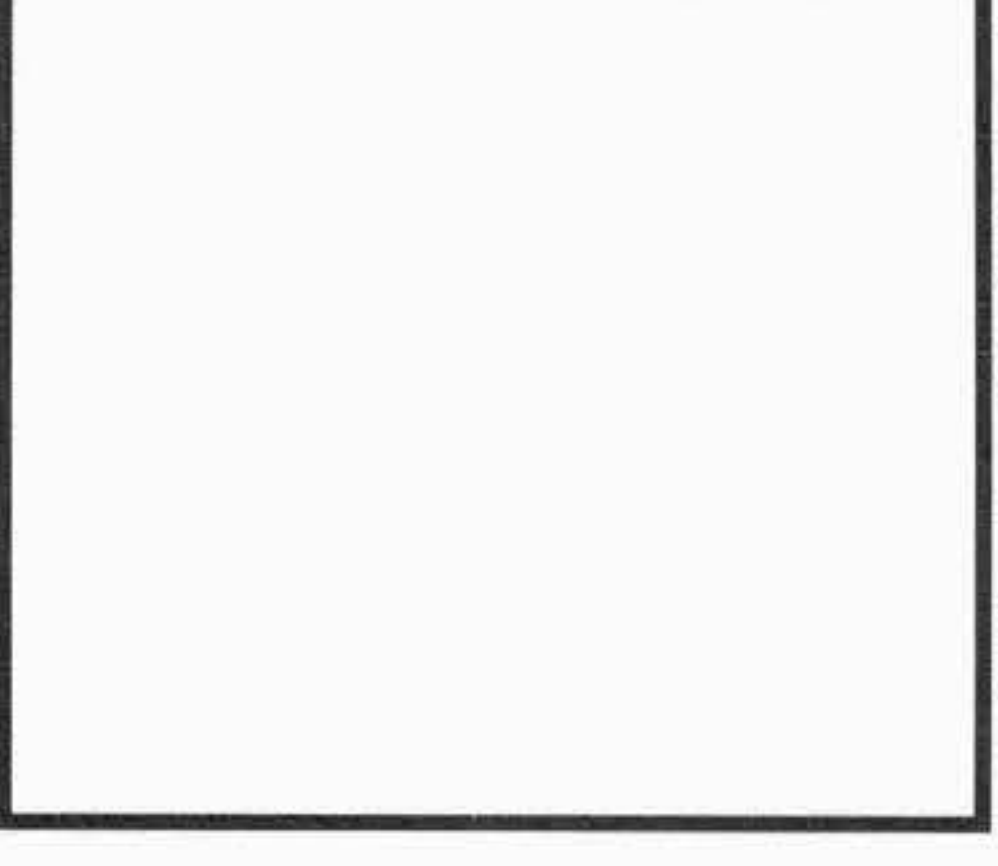
TIPO O MODELLO TYPE OU MODELE TYPE OR MODEL	MOTORE MOTEUR ENGINE	POMPA ACQUA POMPE A EAU WATER PUMP	KIT RIPARAZIONE NECESSAIRE DE REP. REPAIR KIT
FIAT - OM - UNIC 50 AI 329	CO 3 CO 3	191.995 8829770 	212.044 61142732 
FIAT - OM - UNIC 50 AI 110 AI 314/2 - 314/3 315 316 416 A	8040.02 8060.12 8060.12 8060.12 8060.12 8060.12	196.319 93191101 	222.260 76029352 
FIAT - OM - UNIC 130 AI	CP 3 var.32 / 48	191.410 8829777 	192.027 61142734 
OM LUPETTO AI 5 (—> n. 500808)	CO 3 var. 2	196.055 8829832 	212.046 --- 

I ricambi non sono originali ma adattabili . Ogni riferimento originale é assolutamente indicativo .
 Spare parts are not original but perfectly suitable . Every original part number has to be considered for reference purpose only .

SUITABLE

IVECO







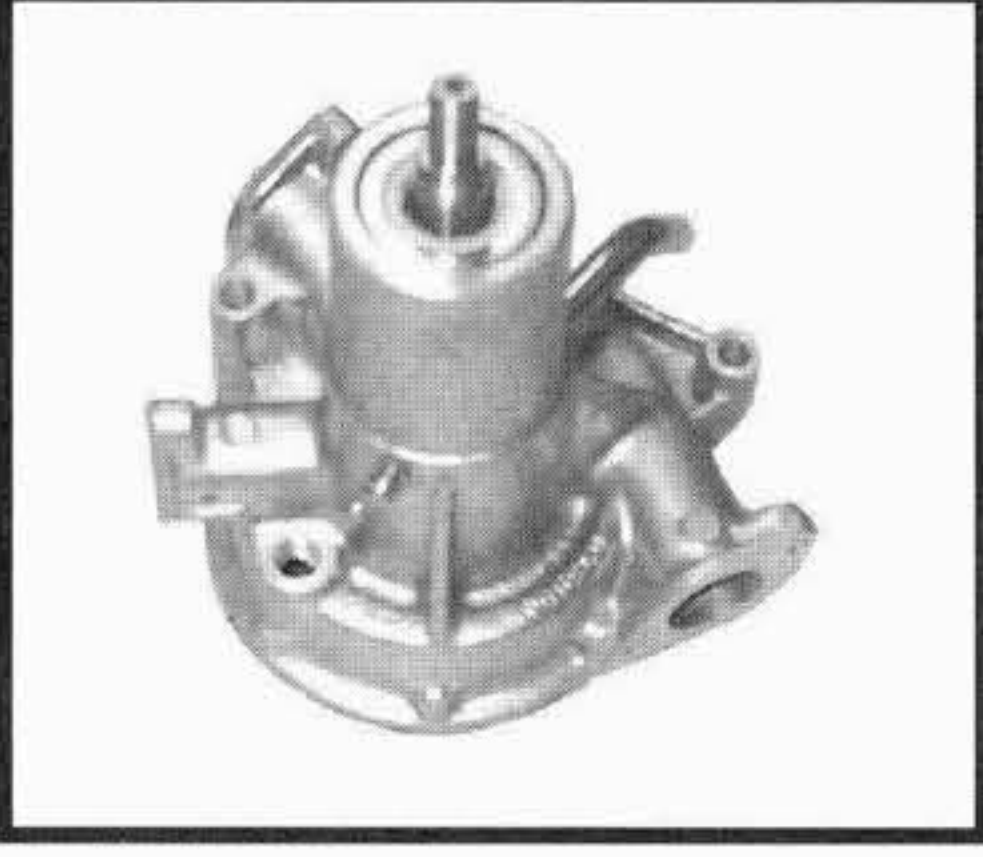

FIAT - OM - UNIC

AUTOBUS - AUTOCARS - BUSES

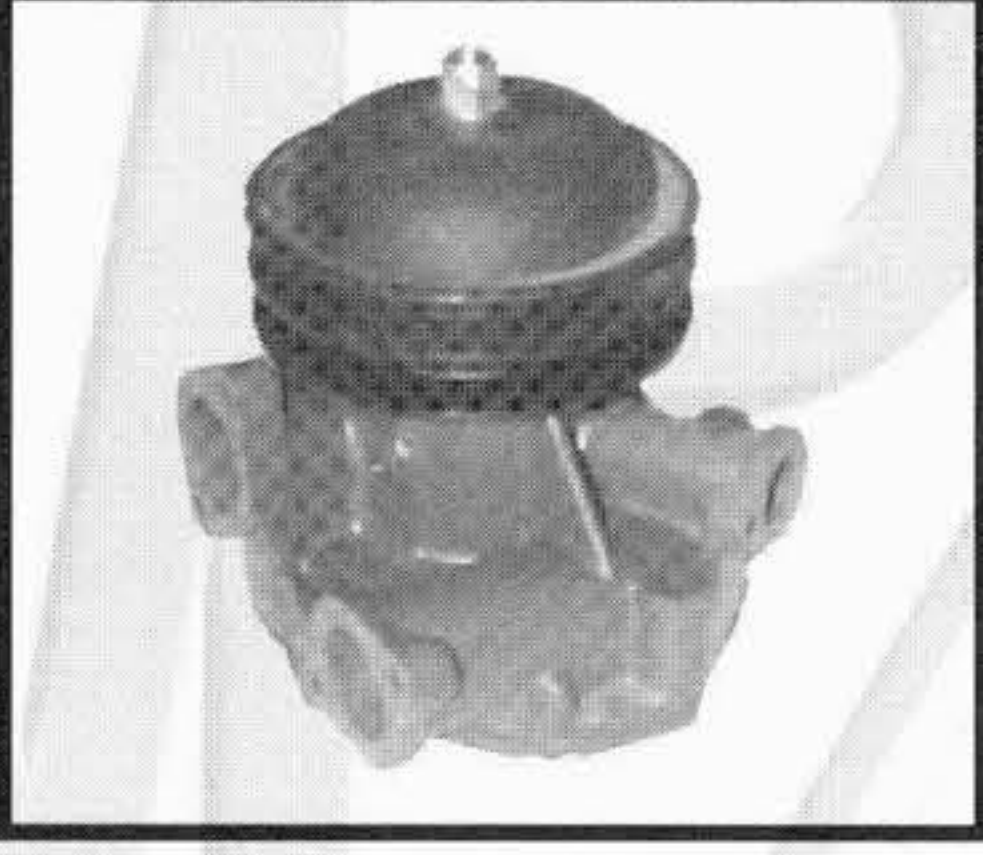
Tel: +44(0)1925 850082 Fax: +(0)44 1925 850083

www.spwaterpumps.co.uk



TIPO O MODELLO TYPE OU MODELE TYPE OR MODEL	MOTORE MOTEUR ENGINE	POMPA ACQUA POMPE A EAU WATER PUMP	KIT RIPARAZIONE NECESSAIRE DE REP. REPAIR KIT
		OMP REF. / O.EM. REF	OMP REF. / O.EM. REF
FIAT 401 UM 405 - 405/2 411	203 203 203	<p>191.618 996342</p> 	<p>192.023 ---</p> 
FIAT 410	309 - 310 H / 6	<p>261.360 4636994</p>  <p>Puleggia a 2 gole</p>	<p>262.066 ---</p> 
FIAT 421 A - 421 AL	8210.12.272	<p>261.650 4665576</p> 	<p>262.082 1902661</p> 
			

I ricambi non sono originali ma adattabili . Ogni riferimento originale é assolutamente indicativo .
 Spare parts are not original but perfectly suitable . Every original part number has to be considered for reference purpose only .

SUITABLE

IVECO

AUTOBUS - AUTOCARS - BUSES - OMNIBUSSE

Tel: +44(0)1925 850082 Fax: +(0)44 1925 850083

www.spwaterpumps.co.uk

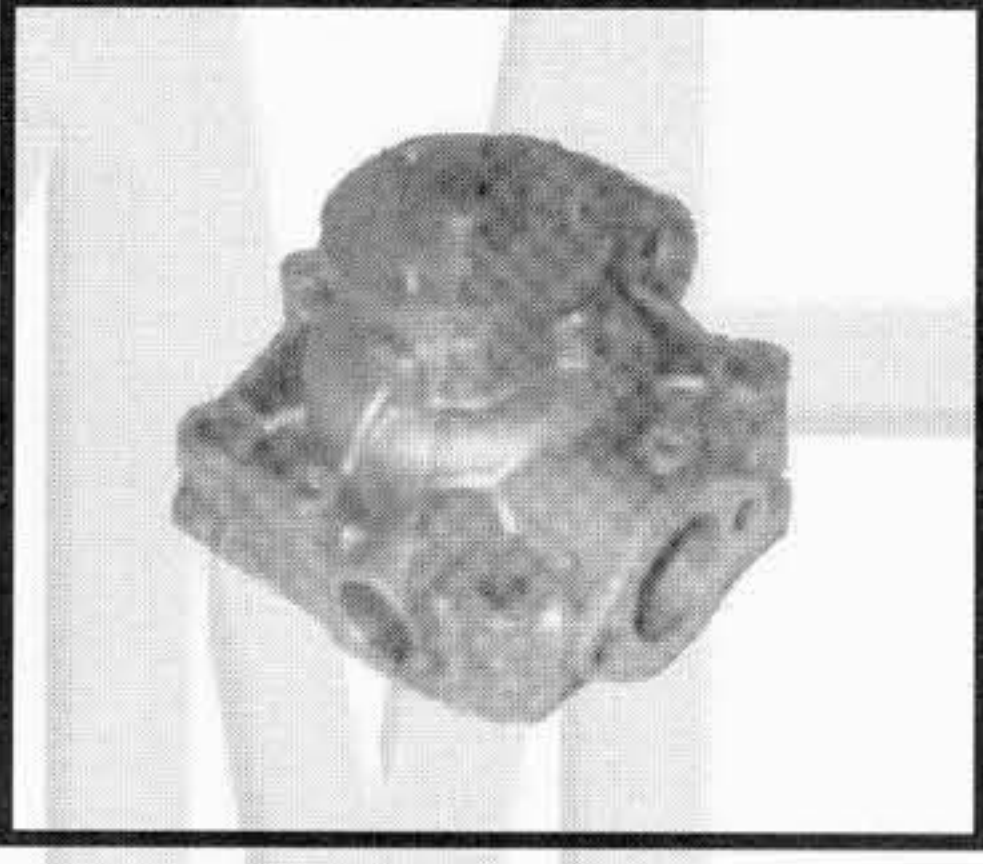
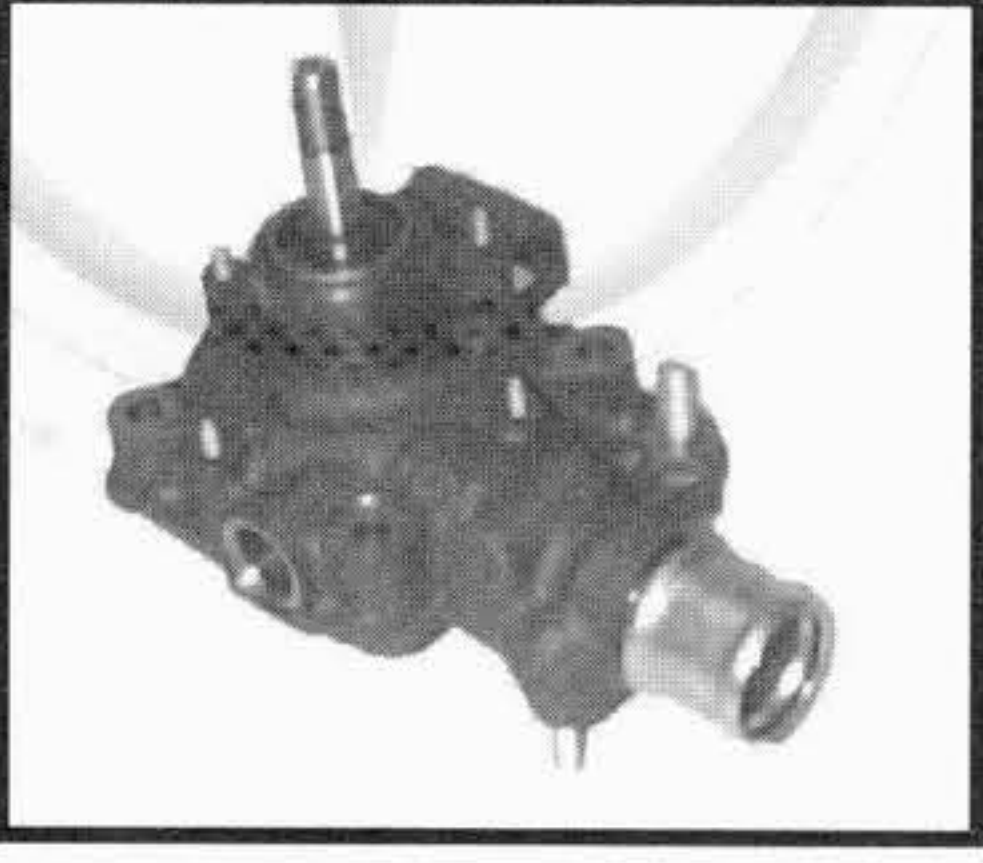
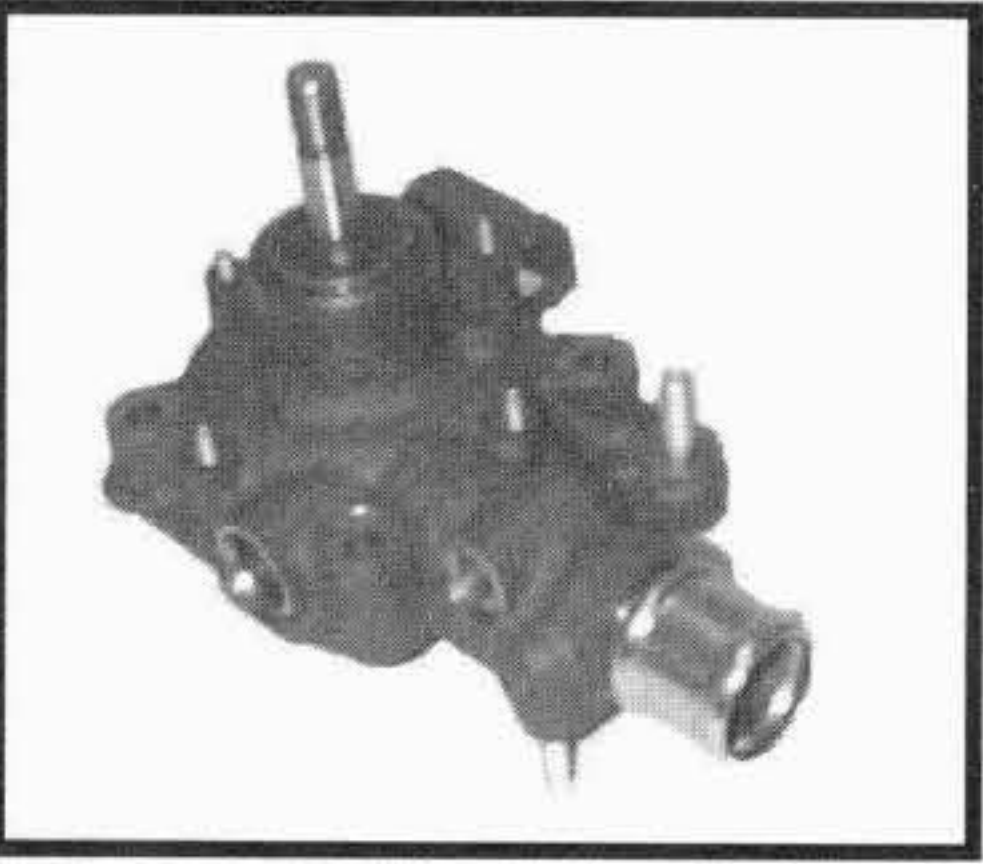

TIPO O MODELLO TYPE OU MODELE TYPE OR MODEL	MOTORE MOTEUR ENGINE	POMPA ACQUA POMPE A EAU WATER PUMP	KIT RIPARAZIONE NECESSAIRE DE REP. REPAIR KIT
<p>DAILY</p> <p>A28.8 - A30.8 - A32.8 A35.8 - A40.8</p> <p>NEW DAILY</p> <p>A30.8 - A35.8 - A40.8</p>	<p>8140.61.200 53 / 72</p> <p>4 cyl. 2500 cm³</p>	<p>196.549 99440728</p> 	<p>---</p> <p>---</p> <p>NON DISPONIBILE NOT AVAILABLE</p>
<p>A 45.10 - A 49.10</p> <p>A40.10 W (4 X 4)</p>	<p>8140.61.204 68 / 92</p> <p>8140.27.215 76 / 103</p>	<p>196.190 7303056</p> 	<p>---</p> <p>---</p> <p>NON DISPONIBILE NOT AVAILABLE</p>
<p>A35.10 TURBODAILY</p> <p>NEW DAILY</p> <p>A35.10 - A40.10 - A45.10 - A49.10</p> <p>DOWNTOWN</p> <p><i>con elettroventilatore avec ventilateur electric with electric fan</i></p>	<p>4 cyl. 2500 cm³ turbo</p> <p>4 cyl. 2800 cm³ turbo</p>	<p>196.465 99448068</p> 	<p>---</p> <p>---</p> <p>NON DISPONIBILE NOT AVAILABLE</p>
<p>A35.12 TURBODAILY</p> <p>NEW DAILY</p> <p>A35.12 - A45.12 A49.12 - A59.12</p> <p><i>con elettroventilatore avec ventilateur electric with electric fan</i></p>	<p>4 cyl. 2500 cm³ turbo intercooler</p> <p>4 cyl. 2800 cm³ turbo intercooler</p>	<p>196.460 99438900</p> 	<p>---</p> <p>---</p> <p>NON DISPONIBILE NOT AVAILABLE</p>

I ricambi non sono originali ma adattabili . Ogni riferimento originale é assolutamente indicativo .
Spare parts are not original but perfectly suitable . Every original part number has to be considered for reference purpose only .

SUITABLE



IVECO

AUTOBUS - AUTOCARS - BUSES - OMNIBUSSE

Tel: +44(0)1925 850082 Fax: +(0)44 1925 850083

www.spwaterpumps.co.uk

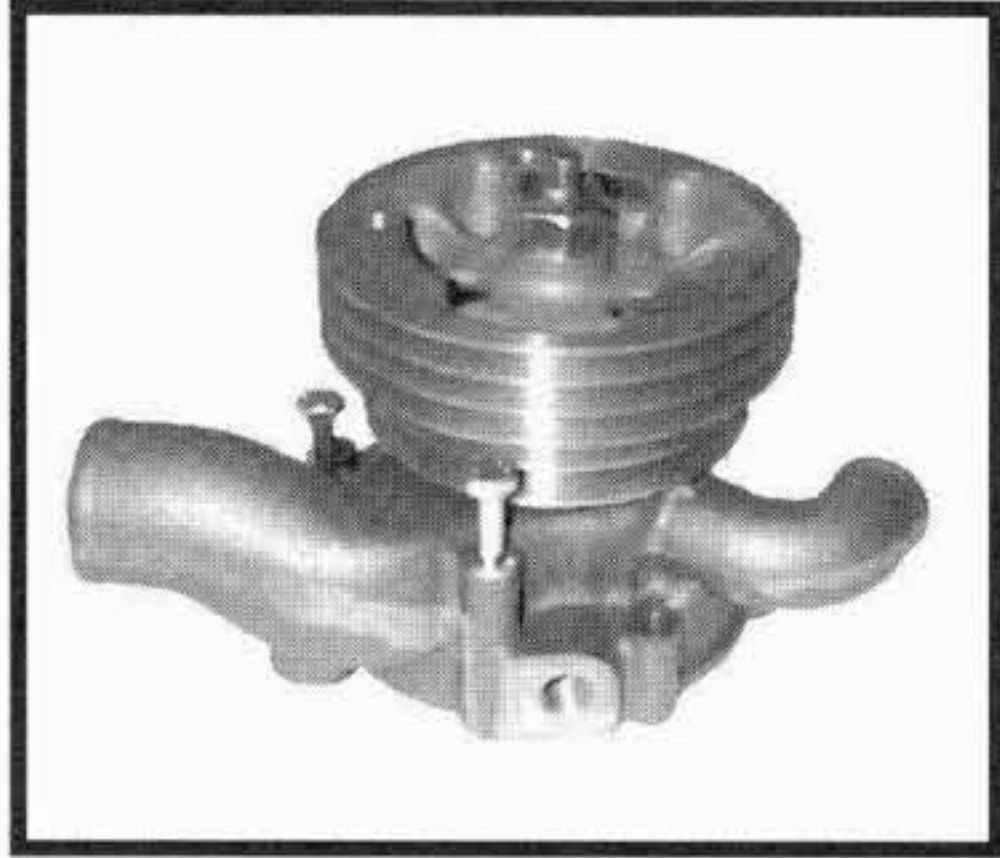
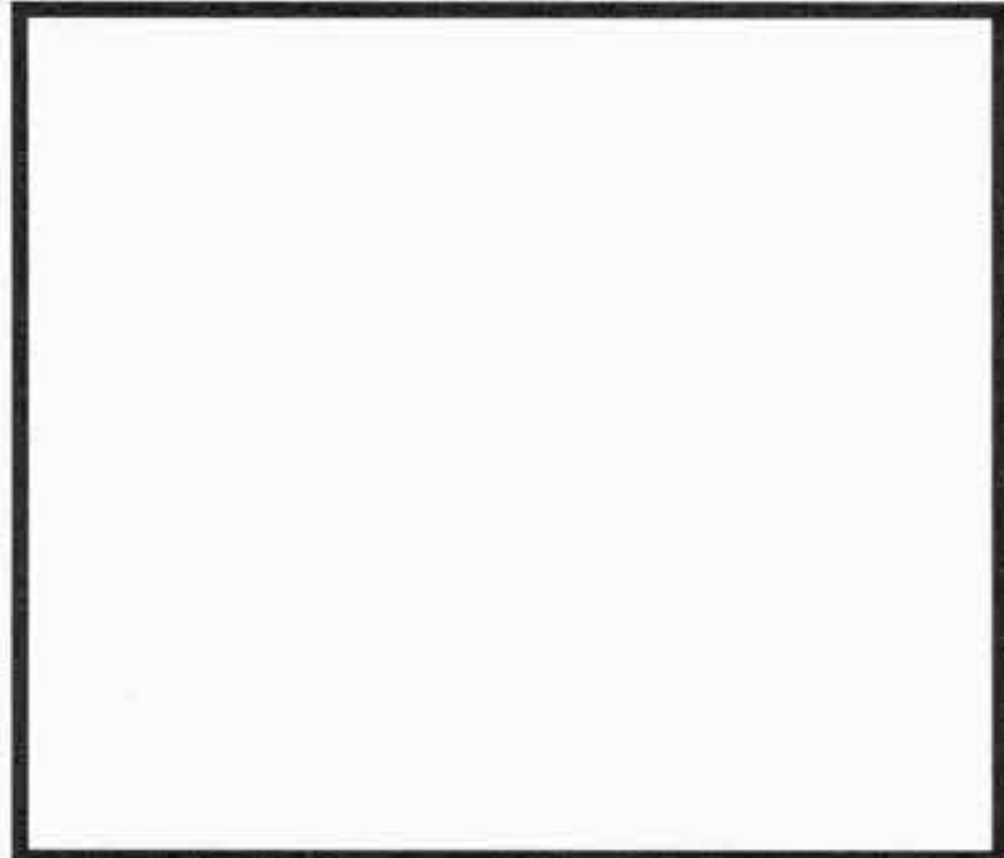
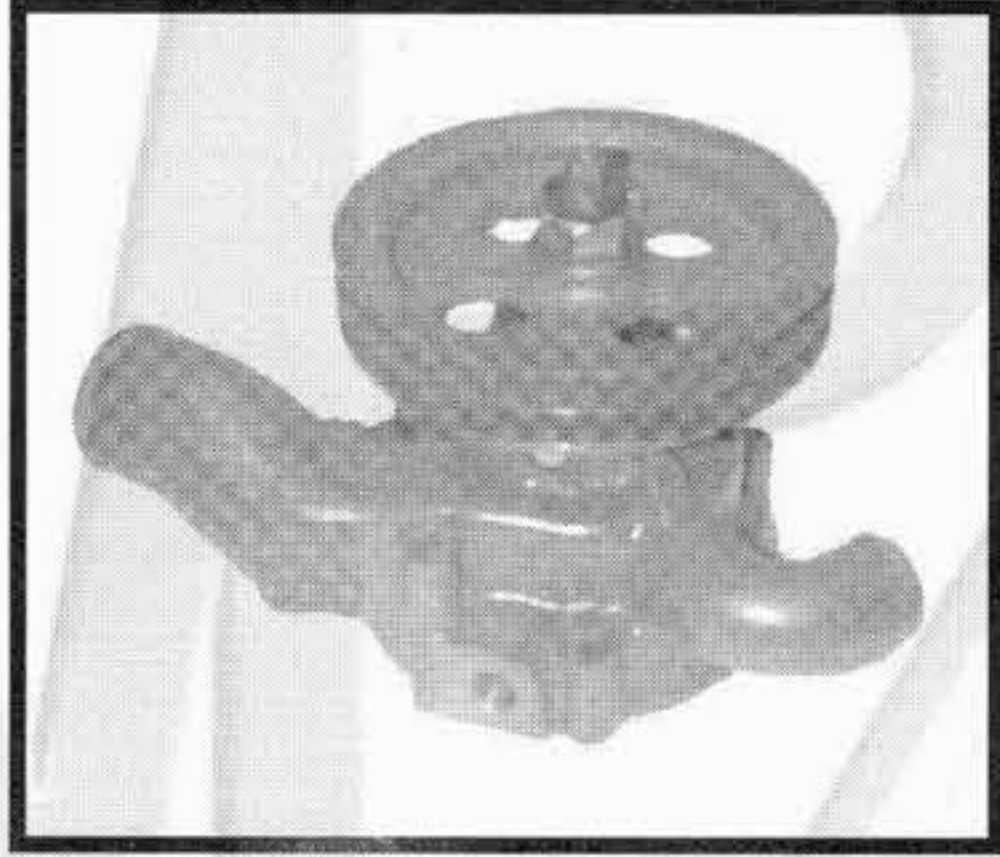
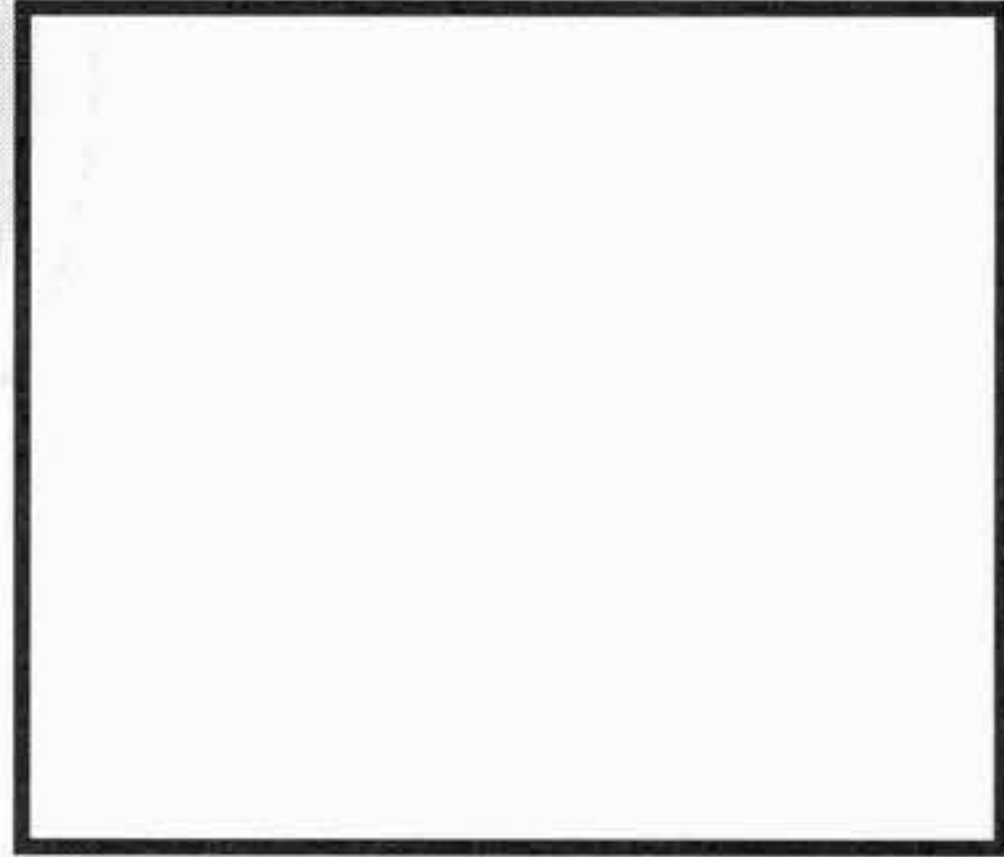
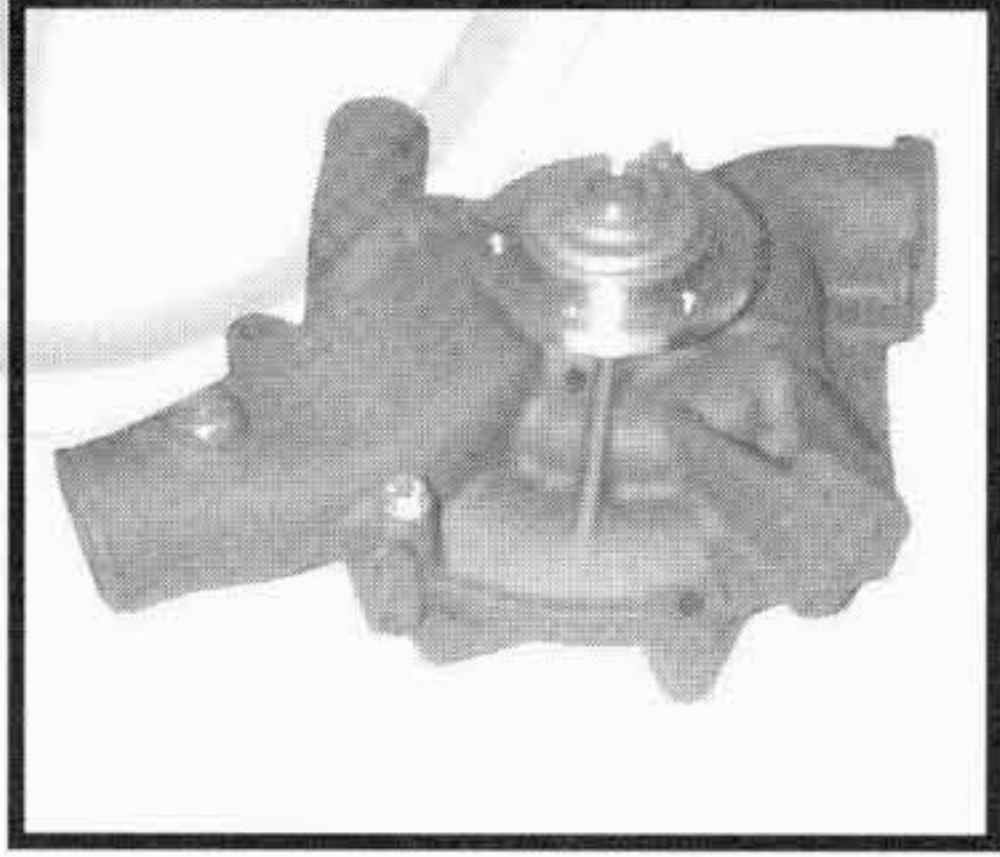
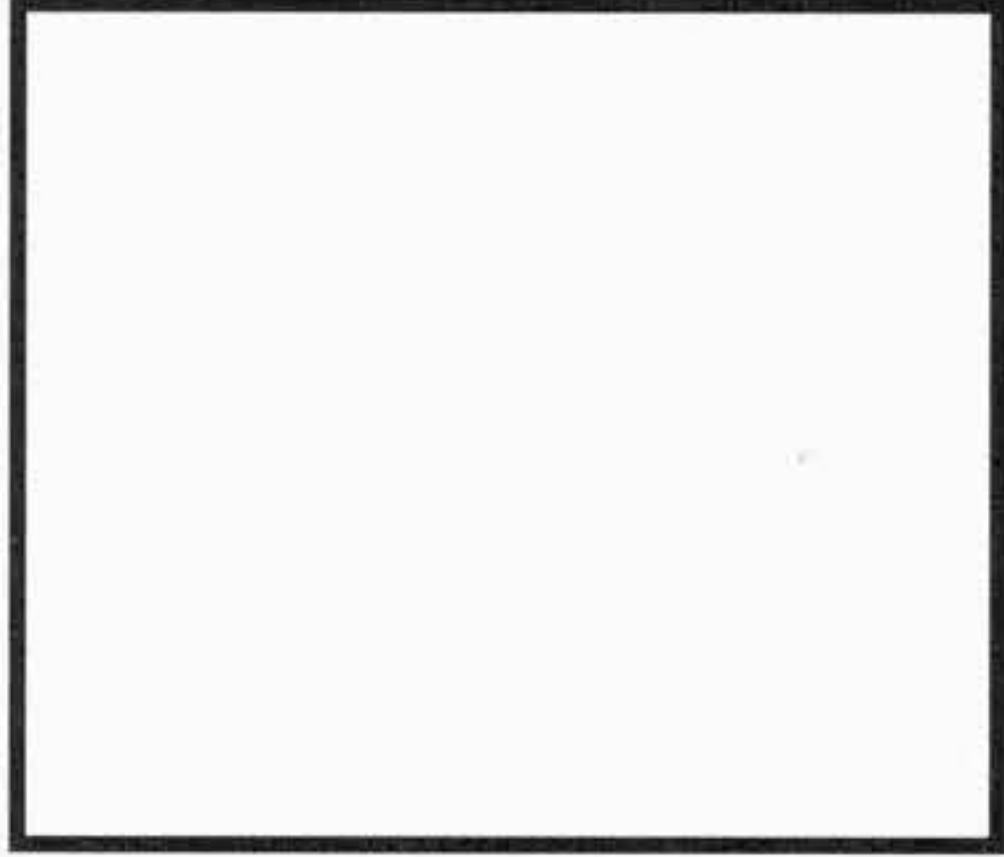

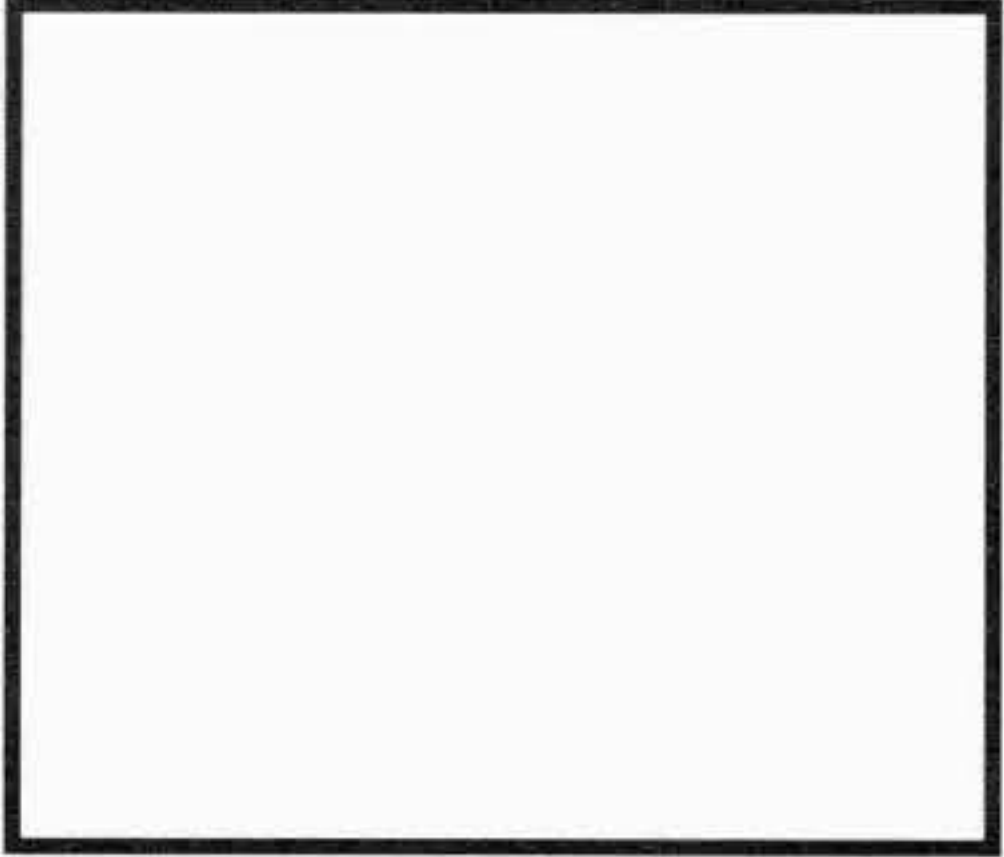
TIPO O MODELLO TYPE OU MODELE TYPE OR MODEL	MOTORE MOTEUR ENGINE	POMPA ACQUA POMPE A EAU WATER PUMP	KIT RIPARAZIONE NECESSAIRE DE REP. REPAIR KIT
		OMP REF. / O.EM. REF	OMP REF. / O.EM. REF
370.10.20	8220.02.701/.834	196.375 61690370 	192.239 1902653 
370.10.24 AP 160.11.24	8220.22	196.345 61690375 	192.239 1902653 
370.10.25 370.12.25 370.12.25 L 370.12.35	8260.02.405 8280.02.405	196.015 4764156 	192.139 1902656 
370.12.26	8210.02.405/.434	191.300 4606023 	192.013 1902659 

I ricambi non sono originali ma adattabili . Ogni riferimento originale é assolutamente indicativo .
Spare parts are not original but perfectly suitable . Every original part number has to be considered for reference purpose only .

SUITABLE





IVECO

AUTOBUS - AUTOCARS - BUSES - OMNIBUSSE

Tel: +44(0)1925 850082 Fax: +(0)44 1925 850083

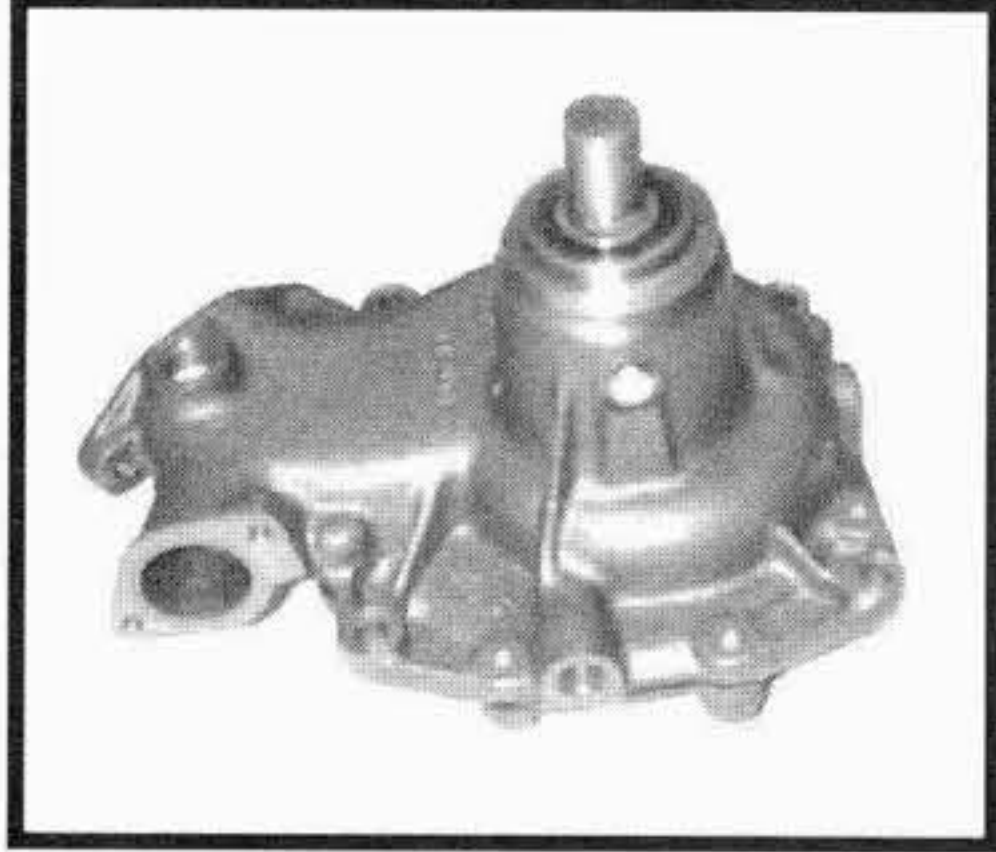
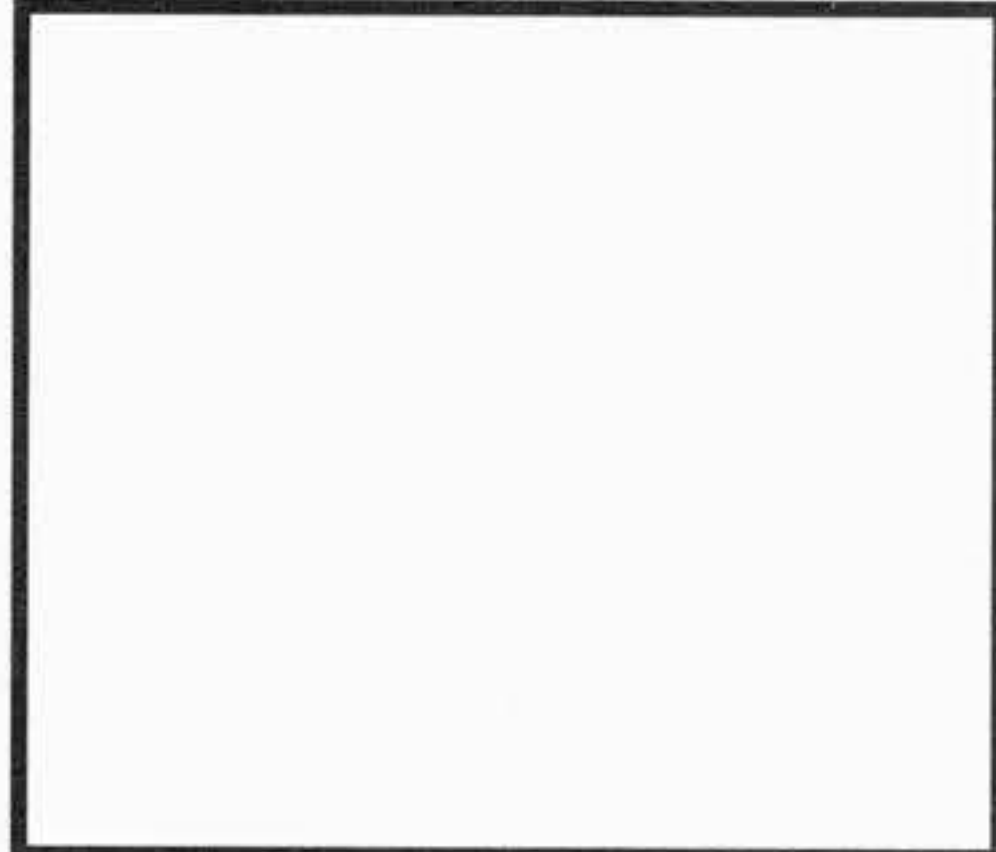
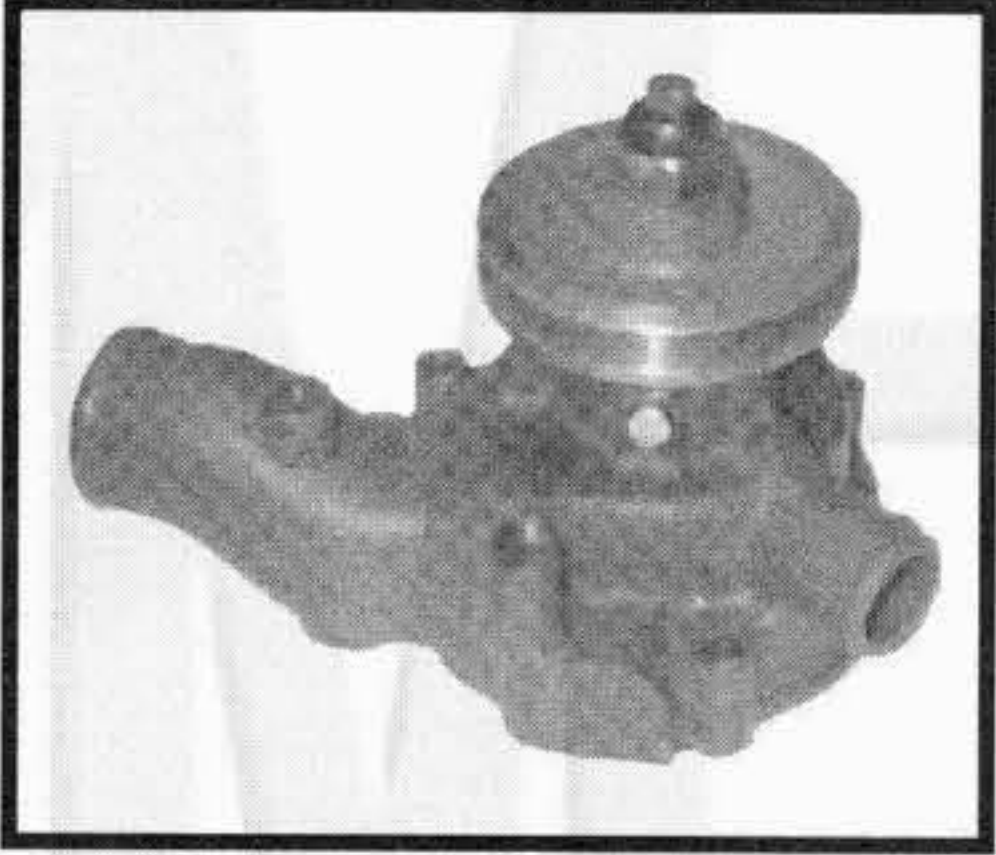
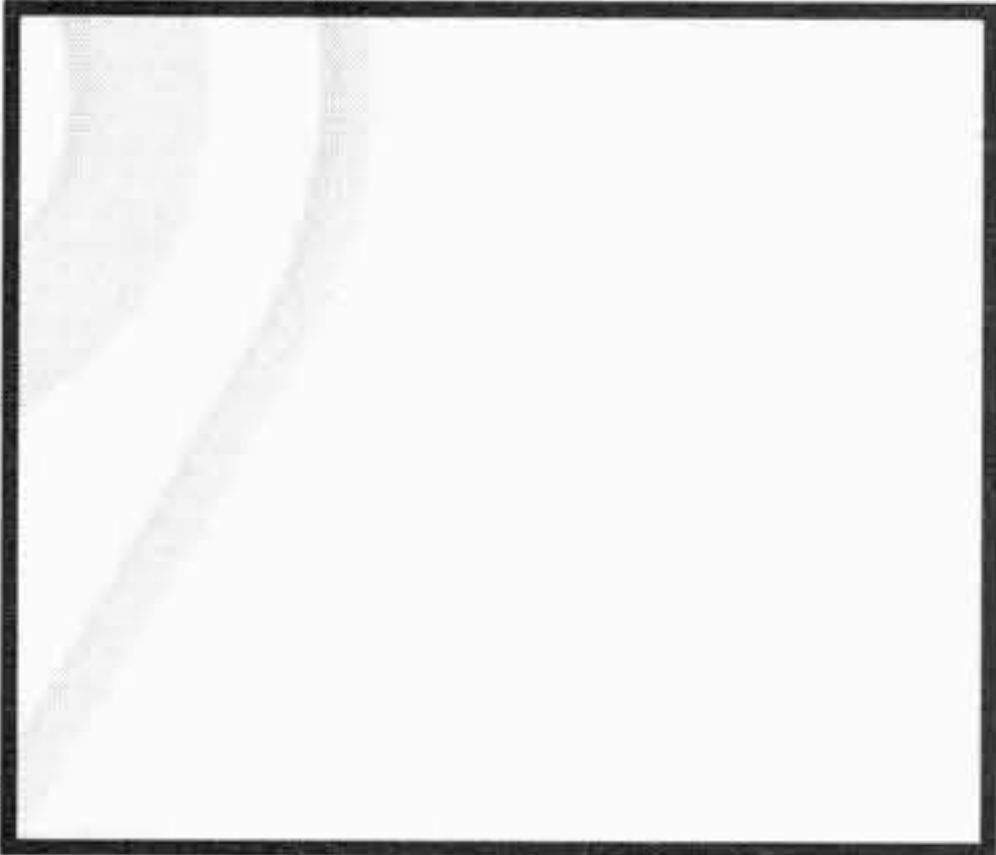
www.spwaterpumps.co.uk

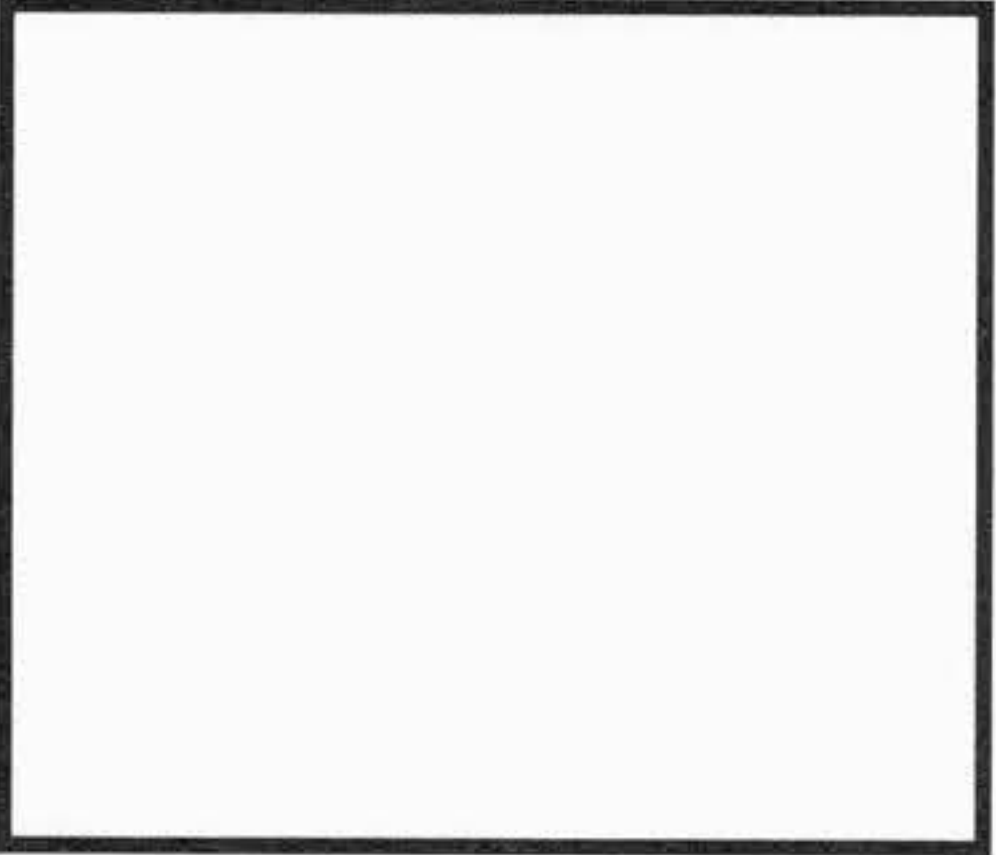
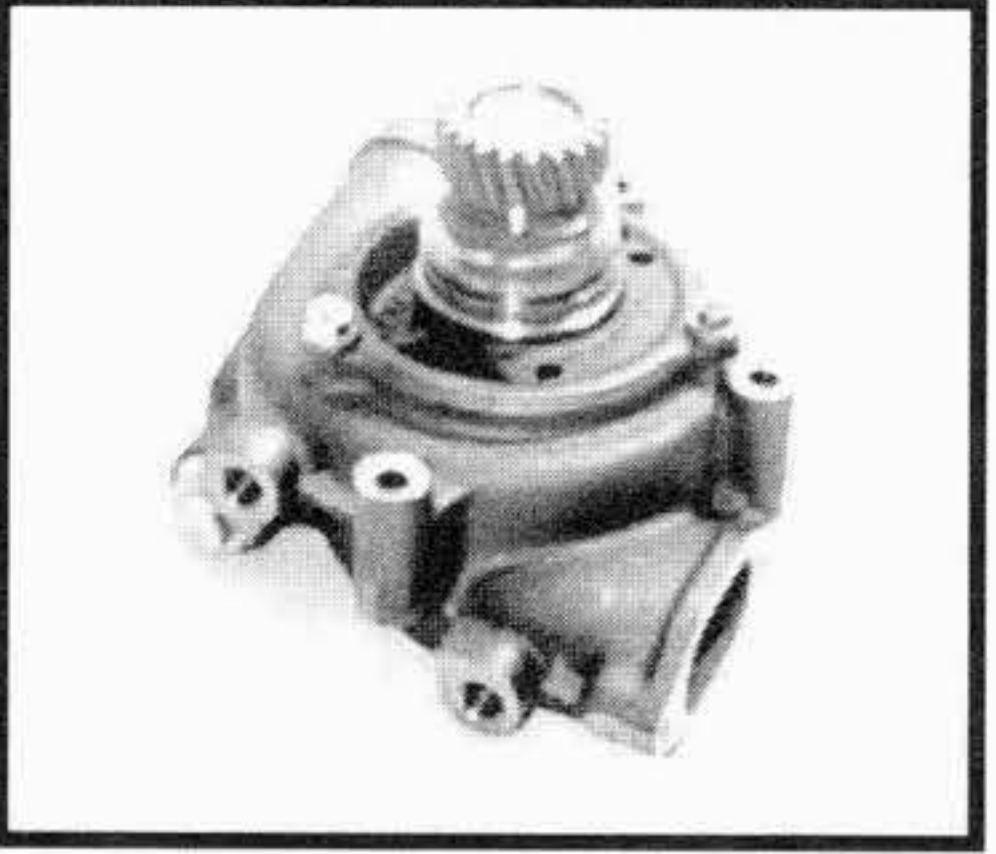

TIPO O MODELLO TYPE OU MODELE TYPE OR MODEL	MOTORE MOTEUR ENGINE	POMPA ACQUA POMPE A EAU WATER PUMP OMP REF. / O.EM. REF	KIT RIPARAZIONE NECESSAIRE DE REP. REPAIR KIT OMP REF. / O.EM. REF
370.12.30	8210.22	191.310 4710552 	192.019 1902655 
470.10.20 - 470.12.20 471.10.20 - 471.12.20 U EFFEUNO 570.10.20 - 570.12.20 571.10.20 - 571.12.20 S-EFFEUNO 670.12.20	8220.12.001/.705 8220.12.721/.723 8220.12.001 8220.12.721 8220.12.001	196.305 61690510 	192.239 1902653 
671.24	8220.32	196.410 61690511 	192.239 1902653 
CITYCLASS 491.10.22 - 491.12.22 491.10.27 - 491.12.27 591.10.22 - 591.12.22 591.10.27 - 591.12.27 370S-E9.27 By DALLA VIA 490.18.29 490E.12.22 590E.12.22	8360.46 6 cyl. 7685 cm ³	216.306 98479917 	216.568 42532082 

I ricambi non sono originali ma adattabili . Ogni riferimento originale é assolutamente indicativo .
 Spare parts are not original but perfectly suitable . Every original part number has to be considered for reference purpose only .

SUITABLE



IVECO

AUTOBUS - AUTOCARS - BUSES - OMNIBUSSE

Tel: +44(0)1925 850082 Fax: +(0)44 1925 850083

www.spwaterpumps.co.uk

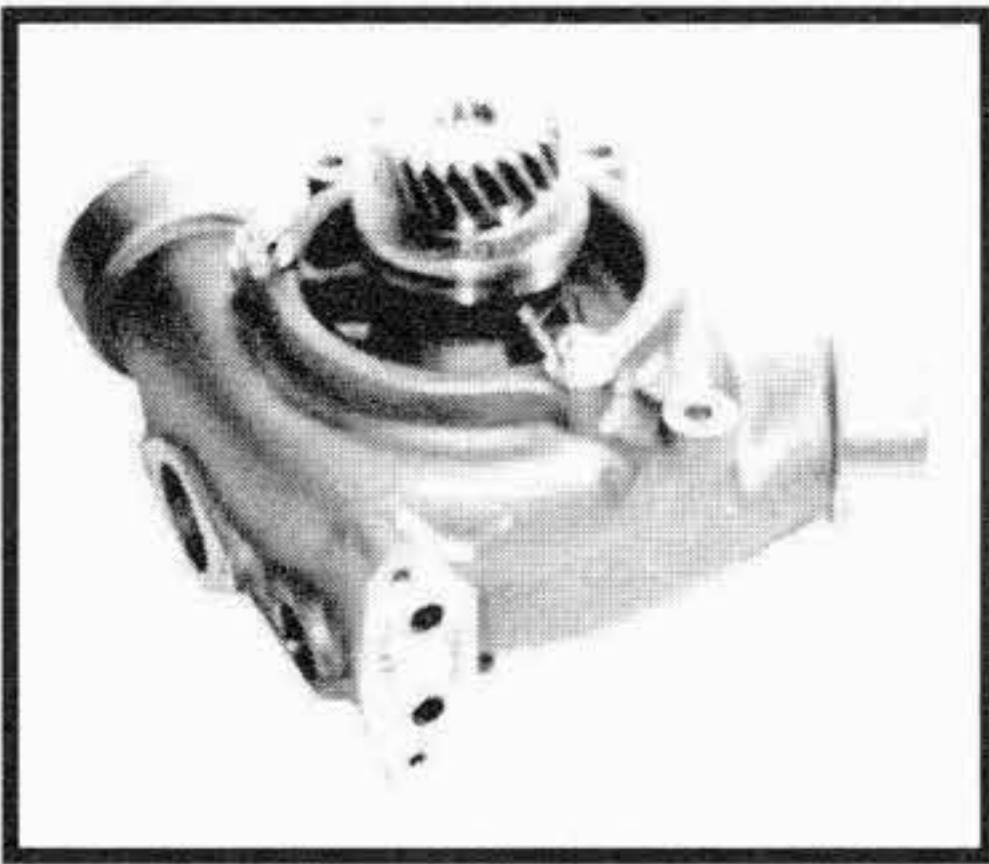
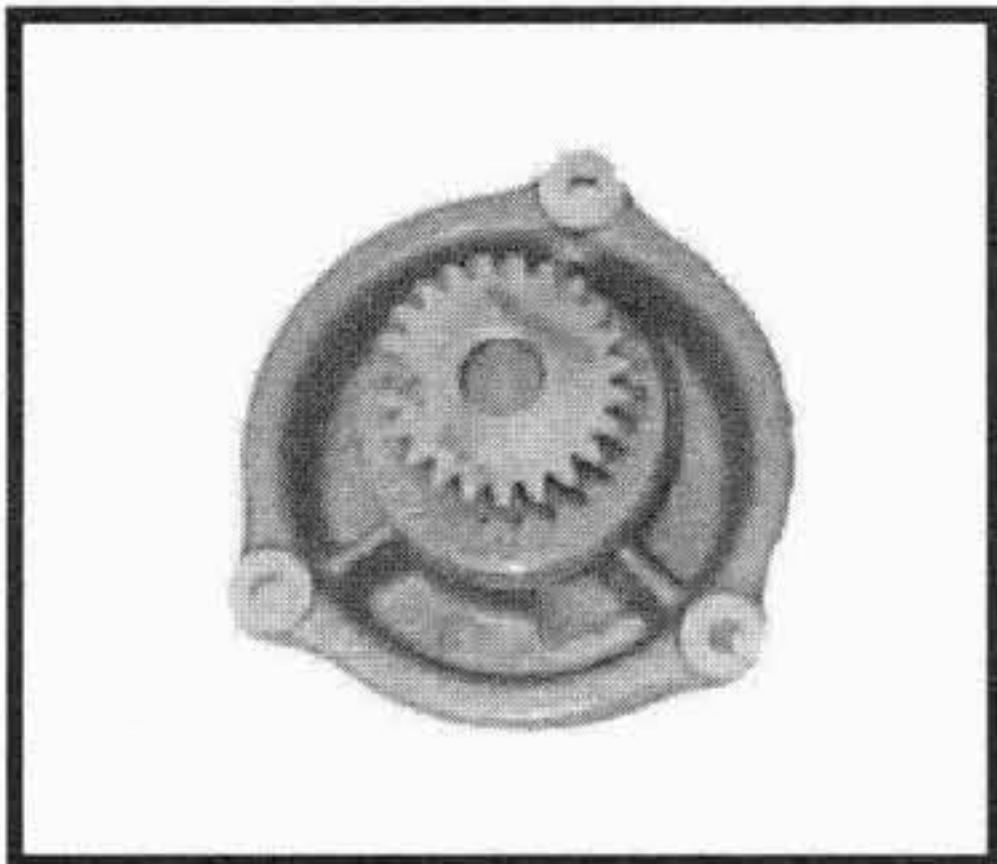
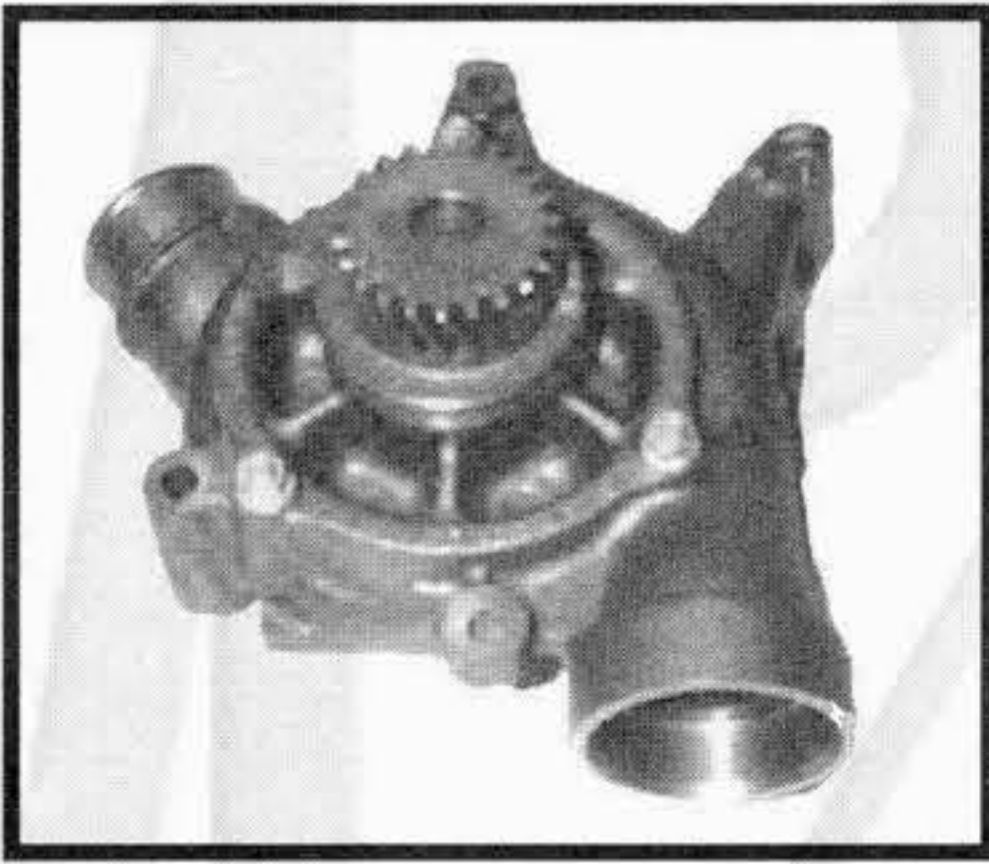
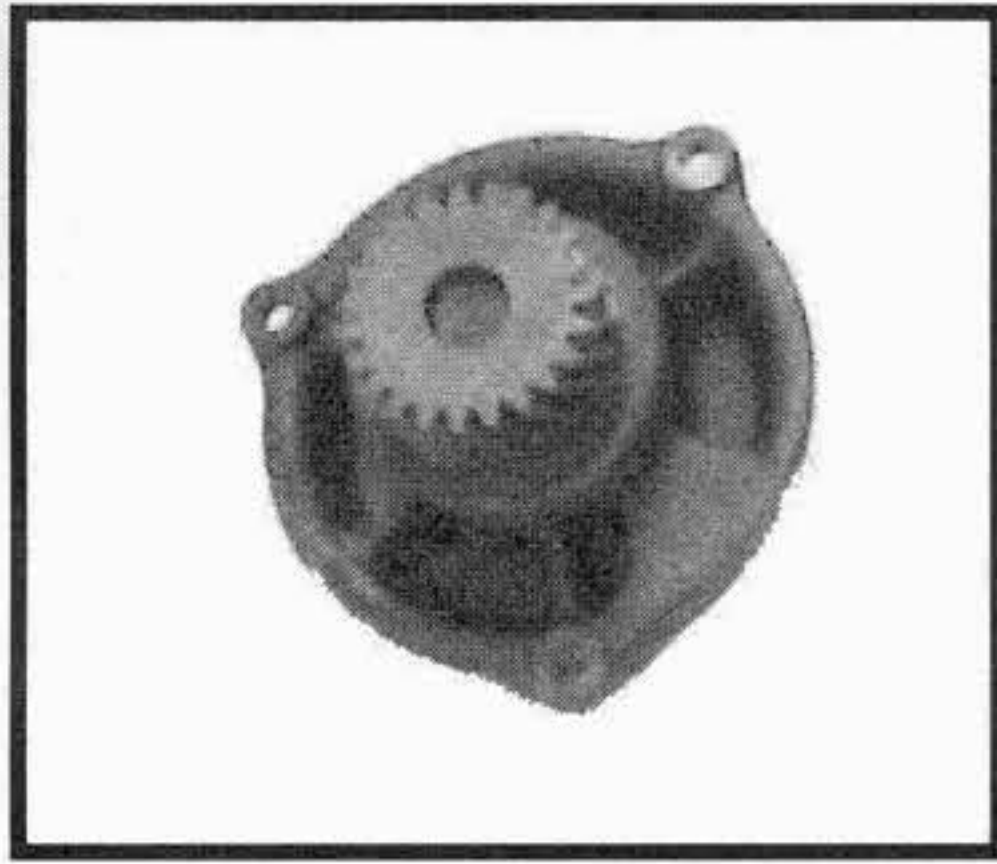

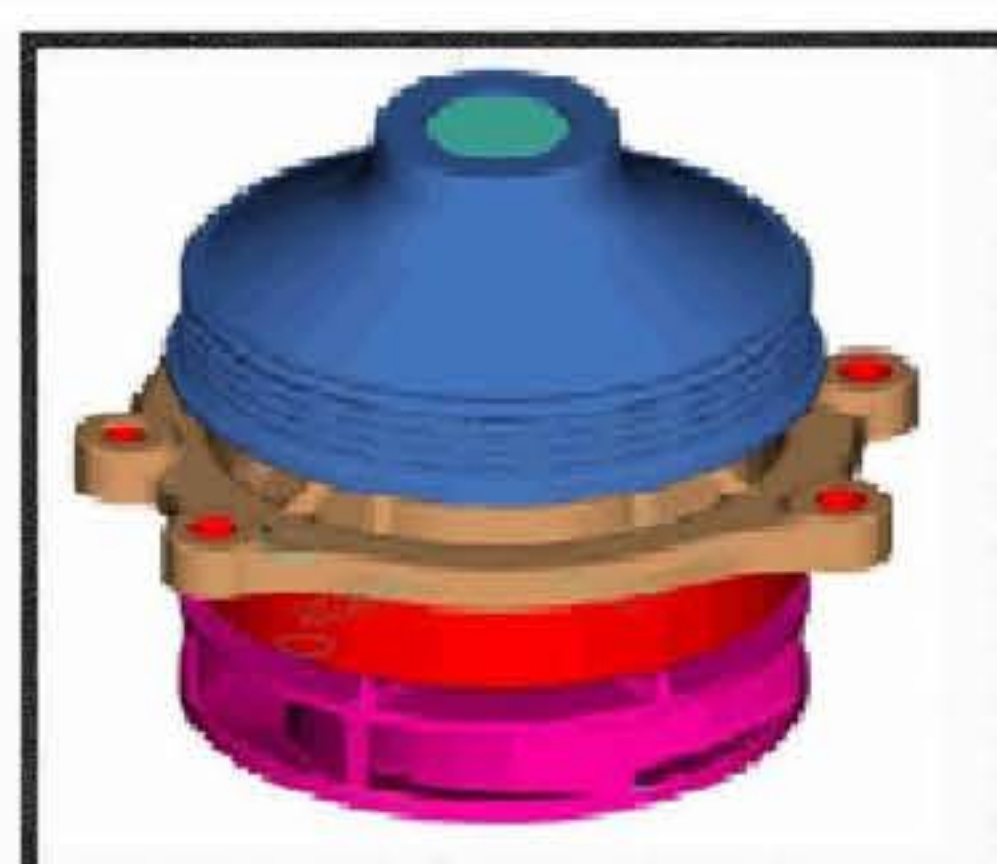
TIPO O MODELLO TYPE OU MODELE TYPE OR MODEL	MOTORE MOTEUR ENGINE	POMPA ACQUA POMPE A EAU WATER PUMP OMP REF. / O.EM. REF	KIT RIPARAZIONE NECESSAIRE DE REP. REPAIR KIT OMP REF. / O.EM. REF
370.S.24 - 480.10.21 480.12.21 - 580.12.21 680.12.26 490E.10.22 R 490E.10.22 R CNG 590E.10.22 R 590.E10.22 R CNG 590.E12.22 R CNG AP 160.24	8460.21 - 8460.41	<p>196.450 61315464</p>  <p>INGRANAGGIO / GEAR</p>	<p>196.251 93190288</p>  <p>Ø = 62,5 mm N° denti = 23</p>
<p>BUS EUROCLASS</p> 380.10.29 - 380.12.29 391.12.29 490.18.29 - 590.18.29 370.12.35 380.10.35 DOMINO 380.12.35 380.12.38 HD TOPCLASS ORLANDI	8460.41R 8460.41S	<p>196.615 61318938</p>  <p>INGRANAGGIO / GEAR</p>	<p>196.293 93190284</p>  <p>Ø = 62,5 mm N° denti = 23</p>
<p>EUROTECH 190E40 - 260E40 - 440E40 190E43 - 260E43 - 440E43</p> <p>EUROSTAR 190E40 - 260E40 - 440E40 190E43 - 260E43 - 440E43 260E48 - 440E48</p> <p>EUROTRAKKER 380E38 K - 410E38 K 380E44 K - 410E44 K 720E44 K 380E48 K - 410E48 K 720E48 K</p>	<p>STRALIS 190S40 - 260S40 440S40 190S43 - 260S43</p> <p>Cursor 10 6Cyl. 10303cc</p> <p>Cursor 13 6 Cyl 12876 cc</p> <p>NEW !!</p>	<p>196.606</p>  <p>OEM 500356553</p>	
<p>EUROTECH 190E27 - 260E27 190E31 - 260E31 190E35 - 260E35 - 440E35</p> <p>EUROMOVER 190E27 190E30</p> <p>EUROTRAKKER 190E31K - 190E35K 340E35 K - 380E35 K</p> <p>STRALIS 190S27 - 260S27 190S31 - 260S31 190S35 - 260S35</p> <p>NEW !!</p>	<p>Curser 8 Cyl 7990cc</p>	<p>196.373</p>  <p>OEM 99483937</p>	<p>196.737</p>  <p>CITYCLASS.35, EURORIDER.35 Cursor 6cyl 7790cc - F2B E0681A OEM 504029280</p>

I ricambi non sono originali ma adattabili . Ogni riferimento originale é assolutamente indicativo .
Spare parts are not original but perfectly suitable . Every original part number has to be considered for reference purpose only .

TYPE OR MODEL	ENGINE	WATER PUMP	REPAIR KIT
FIAT DUCATO MAXI 2.3 JTD IVECO DAILY 2.3 HPI 29L10V 35S10V 29L12V, 35S12V 35C12V, 29L14V 35S14V, 35C14V	2.286cc 4 Cylinder	<p style="text-align: center;">196.665</p>  <p style="text-align: center;">504033770</p>	



SECTION 31

APPLICATION

MAN

WATER PUMPS WASSERPUMPEN
POMPE A EAU BOMBA DE AGUA
POMPA ACQUA

S.P. WATER PUMPS LTD
18 Tatton Court, Kingsland Grange, Woolston,
Warrington, Cheshire. ENGLAND. WAI 4RR
TEL: +44(0) 1925 850082 Fax: +44(0) 1925 850083
Email:sales@spwaterpumps.co.uk Web Site:www.spwaterpumps.co.uk

TAVOLE DI CONVERSIONE
TABLE DE CONVERSION
CONVERSION TABLE

MAN





NUMERO ORIGINALE NUMERO ORIGINAL ORIGINAL NUMBER	NUMERO SOSTITUTIVO REPLACE PAR NUMERO REPLACED BY NUMBER	RIFERIMENTO OMP REFERENCE OMP OMP REFERENCE
06.08040.0607		341.821
06.16050.0112		343.002
06.29020.0125		349.124
06.29020.0128		341.184
06.29020.0131		341.284
06.29020.0132		341.787
06.29140.0110		341.191
06.37769.0051		343.011
06.56180.0709		343.095
06.56190.0713		343.002
06.56190.0718		341.822
06.56331.2164		343.017
06.56341.2122		341.798
51.06500.6095	51.06500.6236	
51.06500.6122	51.06500.6235	
51.06500.6128	VEDI 343.070	
51.06500.6130	51.06500.6200	
51.06500.6147	51.06500.6156	
51.06500.6156	VEDI 343.035	
51.06500.6162	51.06500.6165	
51.06500.6165		343.045
51.06500.6174	51.06500.6184	
51.06500.6184	VEDI 343.040	
51.06500.6200	VEDI 343.050	
51.06500.6222		343.140
51.06500.6235		
51.06500.6236		
51.06500.6228		343.230
51.06500.6282		343.260
51.06500.6302	51.06500.6430	
51.06500.6374	51.06500.6423	
51.06500.6387	51.06500.6282	
51.06500.6408		343.265
51.06500.6423		343.280
51.06500.6426		343.345
51.06500.6430		343.270
51.06500.6476		343.310
51.06500.6479		343.340
51.06500.6480	51.06500.6543	
51.06500.6492		343.350
51.06500.6495		343.320
51.06500.6543		343.330
51.06501.0095		343.072
51.06501.0121		343.039
51.06501.0129		343.065
51.06501.0148		341.826
51.06501.0160		341.836

NUMERO ORIGINALE NUMERO ORIGINAL ORIGINAL NUMBER	NUMERO SOSTITUTIVO REPLACE PAR NUMERO REPLACED BY NUMBER	RIFERIMENTO OMP REFERENCE OMP OMP REFERENCE
51.06501.0164	51.06501.0199	
51.06501.0166		343.287
51.06501.0199		343.271
51.06501.0214		341.971
51.06501.0216		
51.06501.0218		
51.06501.5010		
51.06503.0262		
51.06503.5014		343.275
51.06504.0014		341.786
51.06504.0024		343.279
51.06505.5011		343.099
51.06505.6008		343.075
51.06505.6010		343.249
51.06505.6034	51.06505.6045	
51.06505.6039		343.246
51.06505.6040	51.06505.6042	
51.06505.6042		343.021
51.06505.6044		343.062
51.06505.6045		343.003
51.06505.6047	51.06505.6049	
51.06505.6049		343.032
51.06506.0062		343.139
51.06506.0063		341.799
51.06506.0066		343.272
51.06506.0090		343.229
51.06506.0100		
51.06512.0019		343.027
51.06520.0018	VEDI 343.015	
51.06520.0023	51.06520.0026	
51.06520.0024	VEDI 341.858	341.805
51.06520.0026	51.06520.0032	
51.06520.0032	VEDI 341.858	341.815
51.06520.0037	51.06520.0060	
51.06520.0060	51.06520.0064	
51.06520.0064	51.06520.0068	
51.06520.0068	51.06520.0080	
51.06520.0080		341.858
51.06520.6004	51.06520.6012	
51.06520.6005	51.06520.6013	
51.06520.6012		343.012
51.06520.6013		343.013
51.06599.6002		342.109
51.06599.6005		342.110
51.06599.6007		342.211
51.06599.6008		342.101
51.06599.6012	51.06599.6033	

OGNI RIFERIMENTO ORIGINALE E' ASSOLUTAMENTE INDICATIVO. CHAQUE REFERENCE ORIGINAL EST ABSOLUMENT INDICATIVE. EVERY ORIGINAL PART NUMBER HAS TO BE CONSIDERED FOR REFERENCE PURPOSE ONLY.

SUITABLE

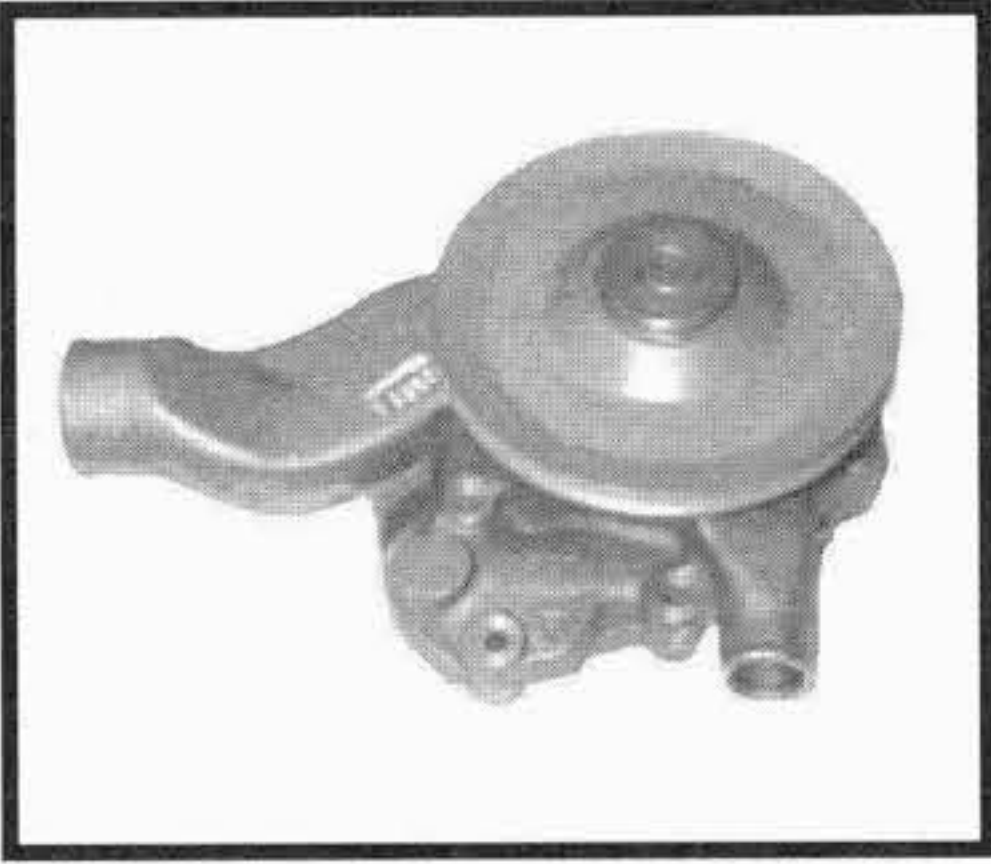
MAN**AUTOCARRI - CAMIONS - TRUCKS - LKW****Tel:+44(0)1925 850082 Fax: +(0)44 1925 850083****www.spwaterpumps.co.uk****SP**
WATER PUMPS

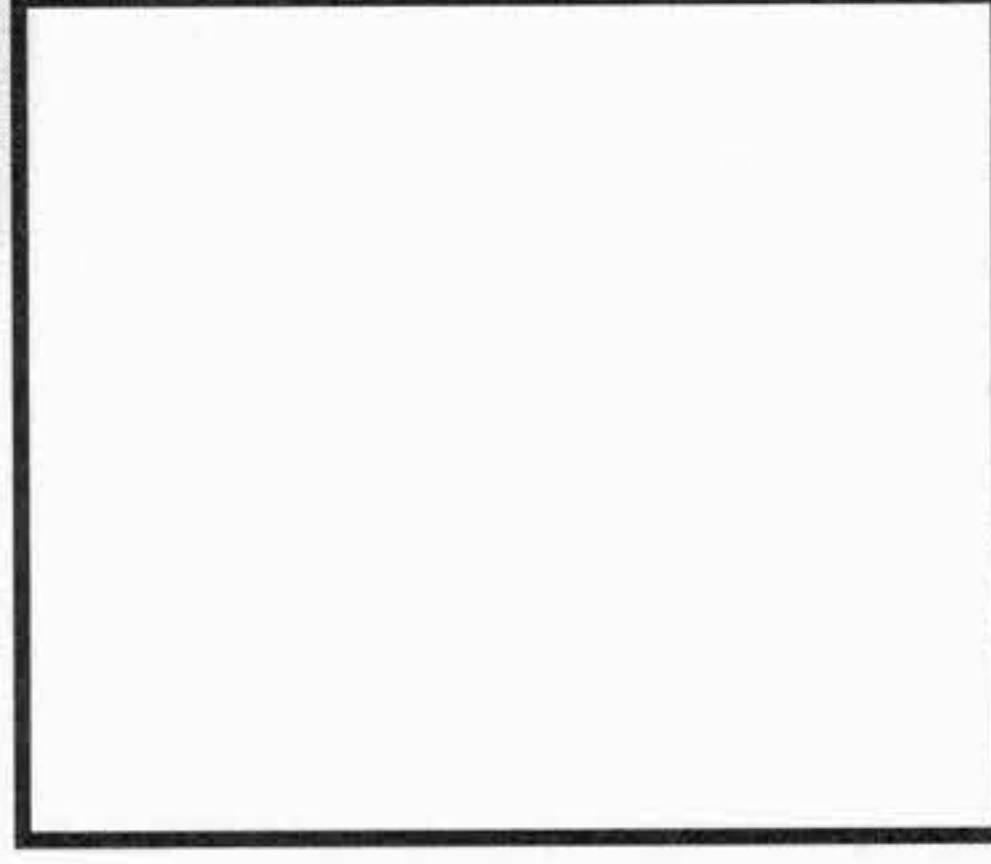
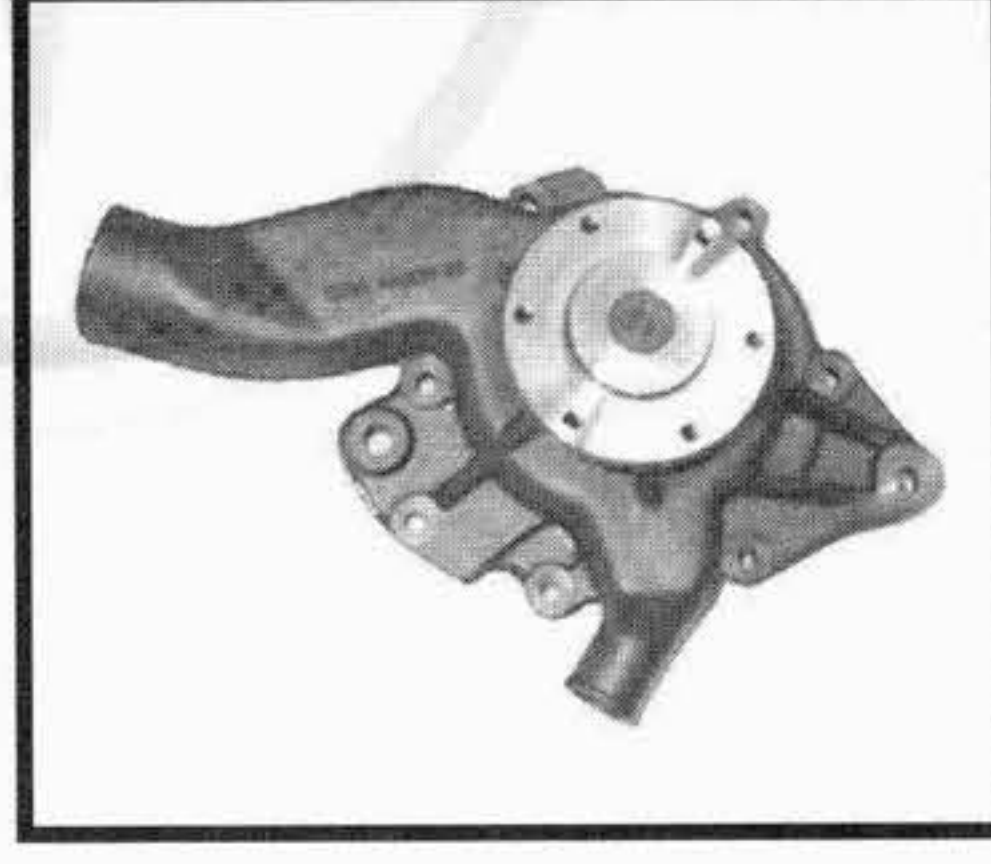
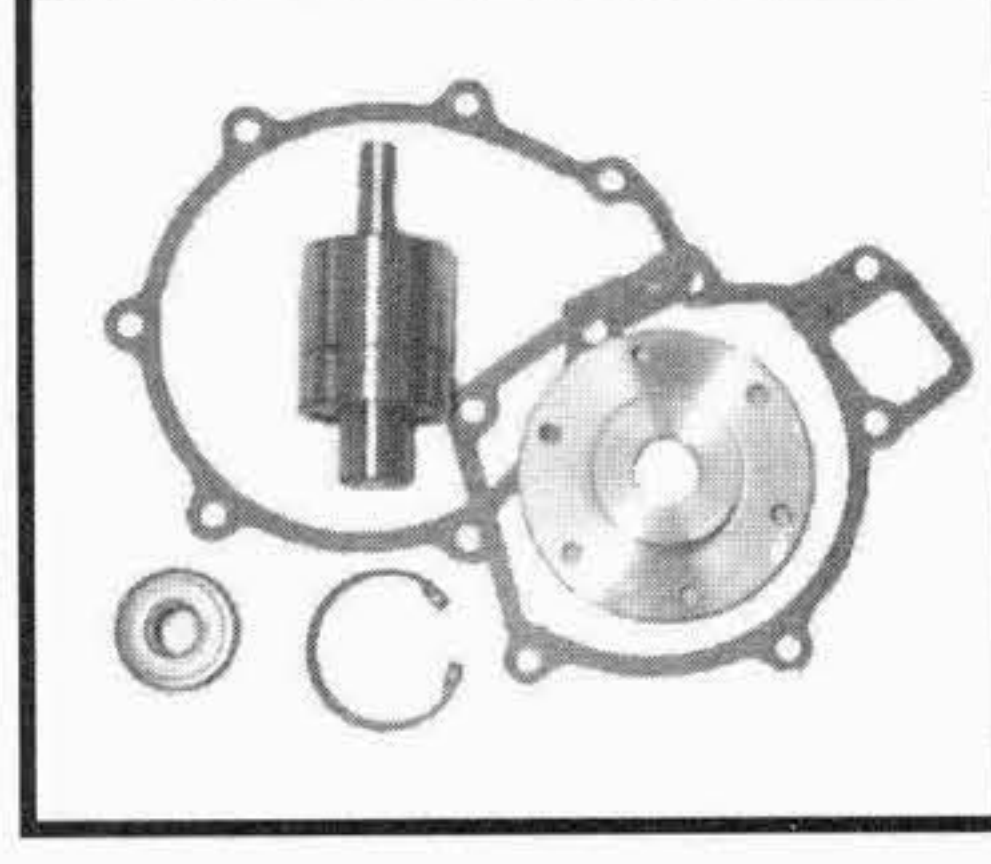
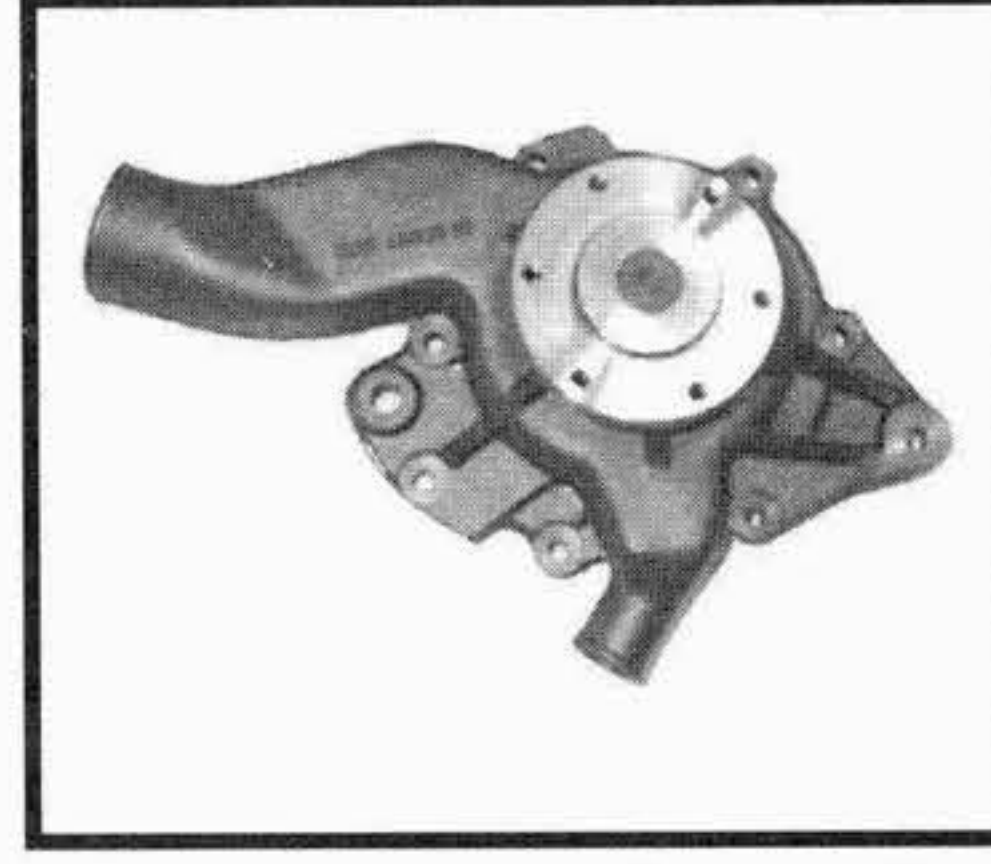
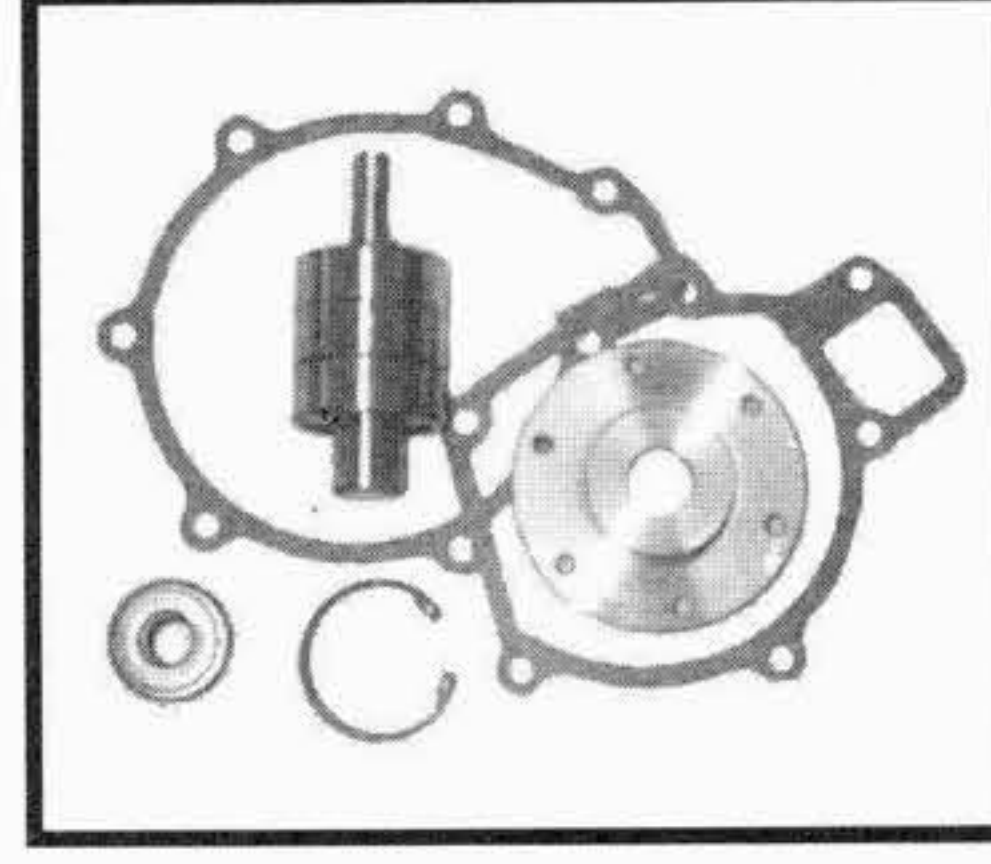

TIPO O MODELLO TYPE OU MODELE TYPE OR MODEL	MOTORE MOTEUR ENGINE	POMPA ACQUA POMPE A EAU WATER PUMP OMP REF. / O.EM. REF	KIT RIPARAZIONE NECESSAIRE DE REP. REPAIR KIT OMP REF. / O.EM. REF
6.90 F / FK 7.90 F / FK 8.90 F / FK 6.100 F / FK - 8.100 F / FK 8.136 F / FS / FK 9.136 F / FS / FK 10.136 F / FK 12.136 F / FL / FK 14.136 F / FL / FK 8.150 F / FL / FS / FK 9.150 F / FS / FK 10.150 F / FL / FK	D 0224 MF D 0824 GF D 0226 MF D 0826 GF	343.270 51.06500.6430 	342.199 51.06599.6023  342.198 51.06599.6022 senza girante / without impeller
12.170 F / FL / FS / FK 14.170 F / FL / FS / FK 16.170 F / FL / FK / FAK 17.170 F / FL / FK / FAK 12.192 F / FL / FS / FK 14.192 F / FL / FS / FK 16.192 F / FL / FS / FK 17.192 F / FL / FS / FK / FAK 14.220 F / FL / FS / FK 15.220 F / FL / FS / FK 16.220 F / FL / FS / FK 17.220 F / FL / FS / FK	D 0226 MKF / 170 D 0226 MKFA / MKH D 0826 LF	343.280 51.06500.6423 	342.238 51.06599.6040  342.240 51.06599.6039 senza girante e mozzo / without impeller & hub
L 90 series 6.100 - 8.150 9.150 - 10.150 M 90 series 12.192 - 14.232 - 17.232 L 2000 series 6.103 - 6.113 - 8.153 - 8.163 8.224 - 9.153 - 10.153 - 10.224 M 2000 series 12.192 - 12.232 - 14.232 11.224 - 13.224 - 15.224 18.224	D0824 LF D0826 LF D0826 LF 01/05 D0826 LF 02/06 D0826 LF 217 D0824 LFL D0826 LFL 03 S & T Reg	343.310 51.06500.6476  note : girante / impeller Ø 125 mm	342.241 - 
M 90 series 18.272 M 2000 series 13.264 - 15.264 - 18.264	D0826 LF04 D0826 LFL09	343.320 51.06500.6495  note : girante / impeller Ø 135 mm	342.241 - 

I ricambi non sono originali ma adattabili . Ogni riferimento originale é assolutamente indicativo .

Spare parts are not original but perfectly suitable . Every original part number has to be considered for reference purpose only .

SUITABLE

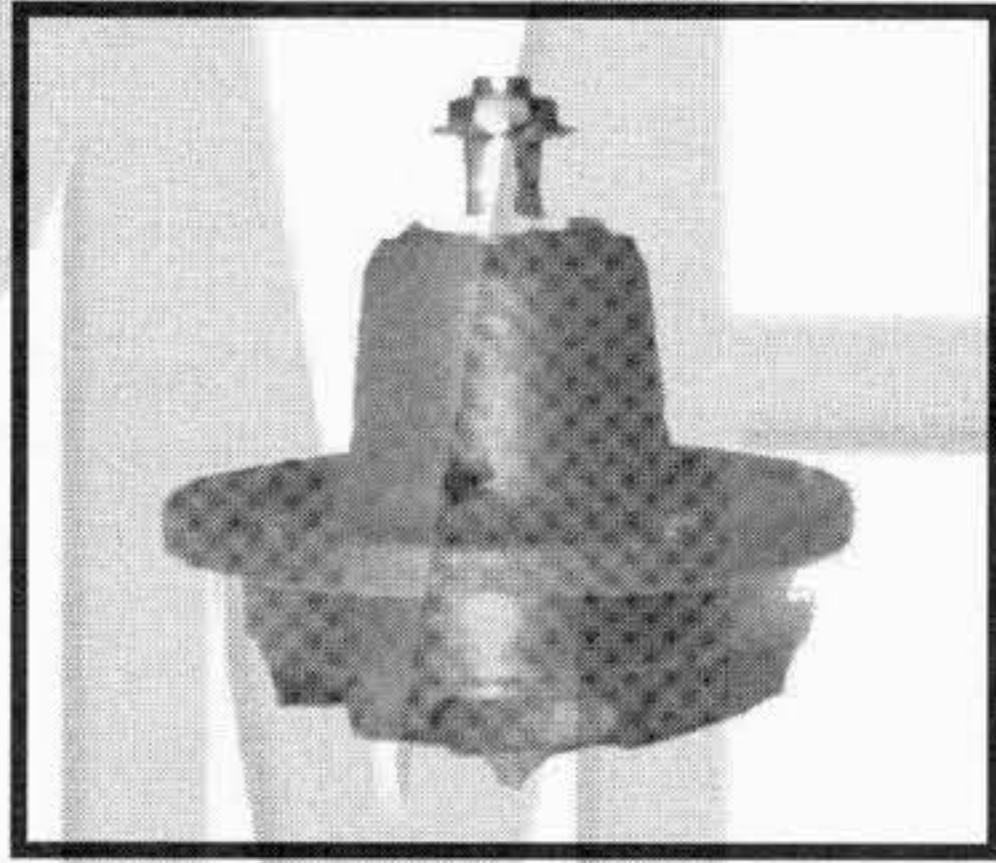
MAN**AUTOCARRI - CAMIONS - TRUCKS - LKW****Tel:+44(0)1925 850082 Fax: +(0)44 1925 850083****www.spwaterpumps.co.uk****SP**
WATER PUMPS







TIPO O MODELLO TYPE OU MODELE TYPE OR MODEL	MOTORE MOTEUR ENGINE	POMPA ACQUA POMPE A EAU WATER PUMP	OMP REF. / O.EM. REF	KIT RIPARAZIONE NECESSAIRE DE REP. REPAIR KIT	OMP REF. / O.EM. REF
8.156 F 8.156 F 9.156 F	D 0836 HMN 70 D 0846 HMN 1 D 0846 HMXN		343.045 51.06500.6495		342.111 51.06599.6007
				343.062 51.06505.6044 albero completo / complete shaft	
9.186 F 9.216 F - 12.215 F 13.215 F - 13.230 F 13.230 F / FS / FK 16.186 F / FN 16.215 FN - 19.215 DF 16.230 F - 19.230 DF 19.230 DH	D 2146 MN D 2156 HMN D 2156 HMN 1/6 D 2356 HMN D 2146 MN 3/11 D 2156 HMN D 2356 HMN D 2356 HM2/4/9		- 51.06500.6156 con basamento / with housing		342.101 51.06599.6008
			343.035 --- senza basamento / without housing		343.003 51.06505.6045 albero completo / complete shaft
9.192 H / HT / HAT / HAK 9.216 H 10.192 H 10.210 HA / HS / HK / HAK 10.230 F - 13.230 F - 16.230 FN 11.210 TL 12.192 H / HT / HAK 12.215 H / HA / HAT - 13.215 H 12.230 H / HT / HAT - 13.230 H 15.230 H - 21.230 DH - 22.230 DH 14.215 H - 15.216 H - 16.215 F 15.215 H - 16.215 H - 19.215 DH / DHA 16.256 H - 19.256 H / DHAK 22.256 H - 26.256 H - 30.256 19.215 F 19.230 F - 26.230 F 21.215 DH - 22.215 DH / DHA / DHAT 22.215 H	D 2156 MY / MX D 2156 HMX D 2156 MY D 2146 MT 1 D 2356 HMXN D 2146 MT 1 D 2156 MY / MX D 2156 HMX / HM3/9 D 2356 HM 2/4/9 D 2356 HM 2/4/9 D 2156 HMX D 2156 HM 3/9 D 2156 MTX D 2156 MTX D 2156 HMY D 2356 HMXN D 2156 HM 3 / 9 D 2156 HMX		- 51.06500.6128 con basamento / with housing		342.110 51.06599.6005
			343.070 --- senza basamento / without housing		343.075 51.06505.6008 albero completo / complete shaft
19.256 H 19.256 DHAK	D 2156 MTN D 2156 MTXN		- 51.06500.6184 con basamento / with housing		342.101 51.06599.6008
			343.040 --- senza basamento / without housing		343.032 51.06505.6049 albero completo / complete shaft

I ricambi non sono originali ma adattabili . Ogni riferimento originale é assolutamente indicativo .

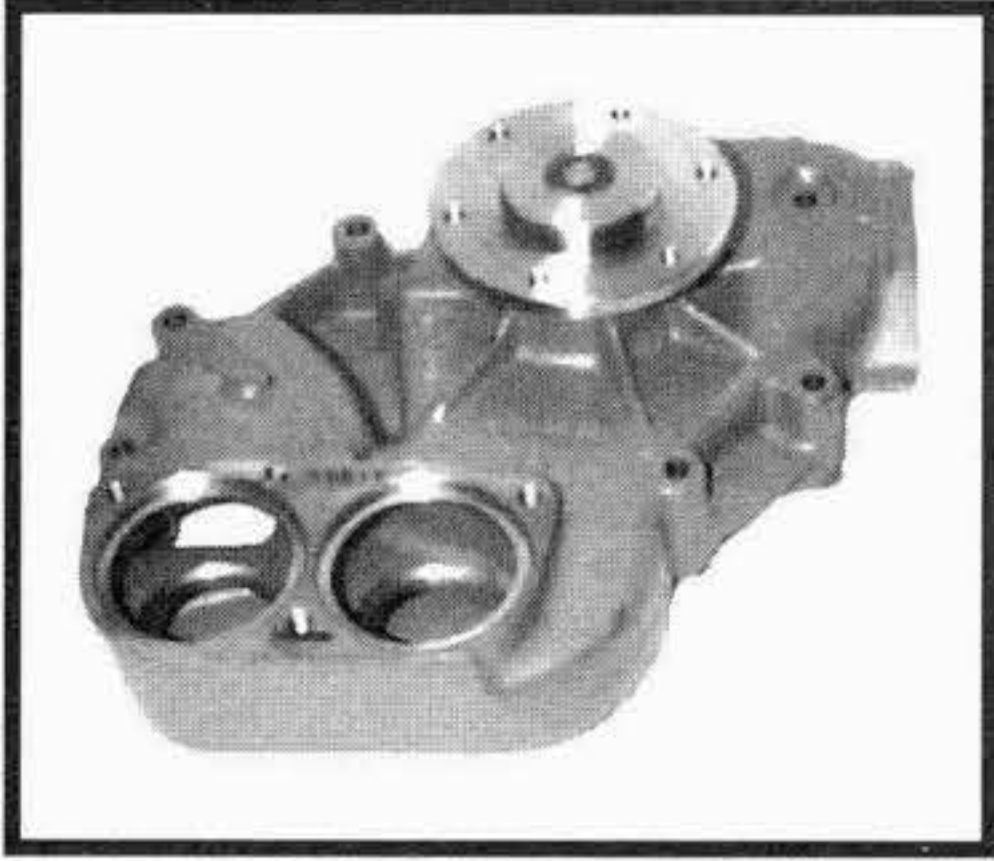
Spare parts are not original but perfectly suitable . Every original part has to be considered for reference purpose only .

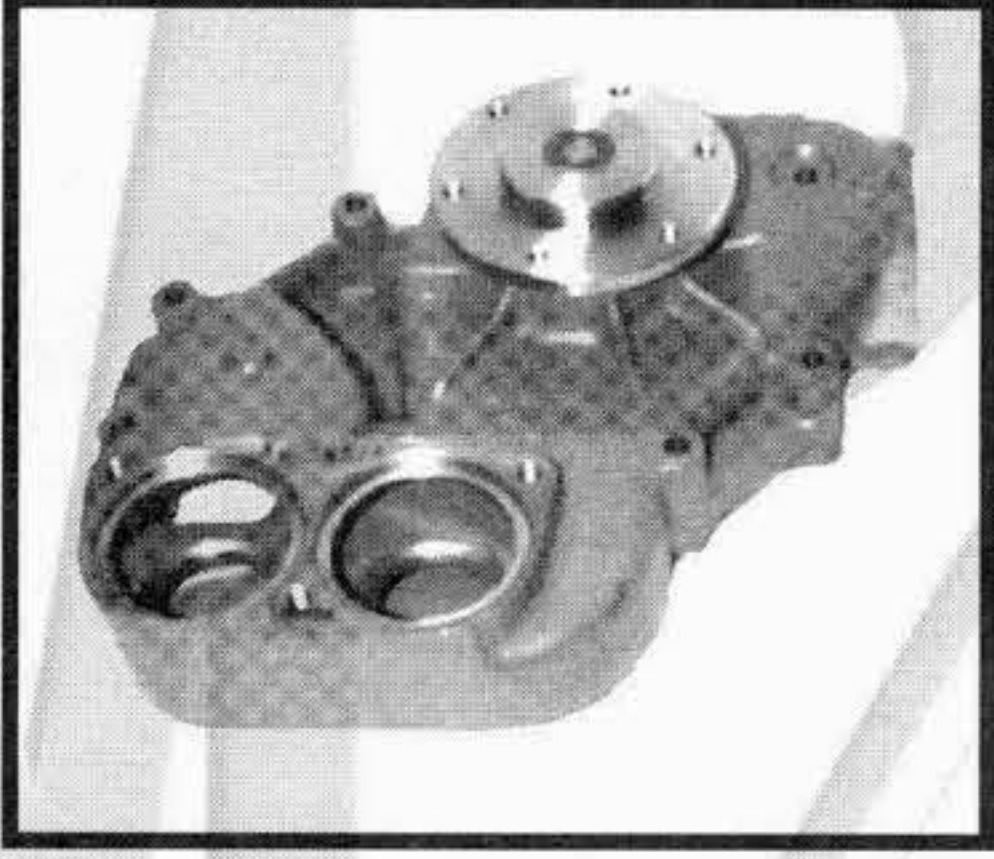
SUITABLE

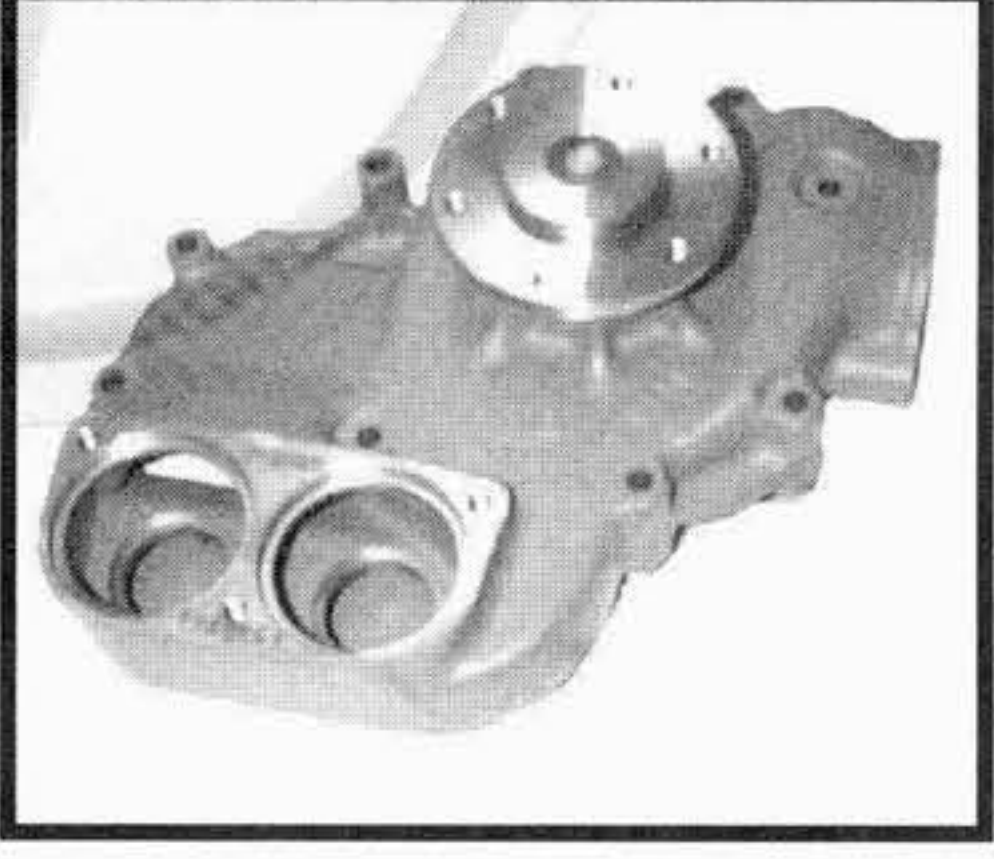
MAN**AUTOCARRI - CAMIONS - TRUCKS - LKW****Tel:+44(0)1925 850082 Fax: +(0)44 1925 850083****www.spwaterpumps.co.uk**

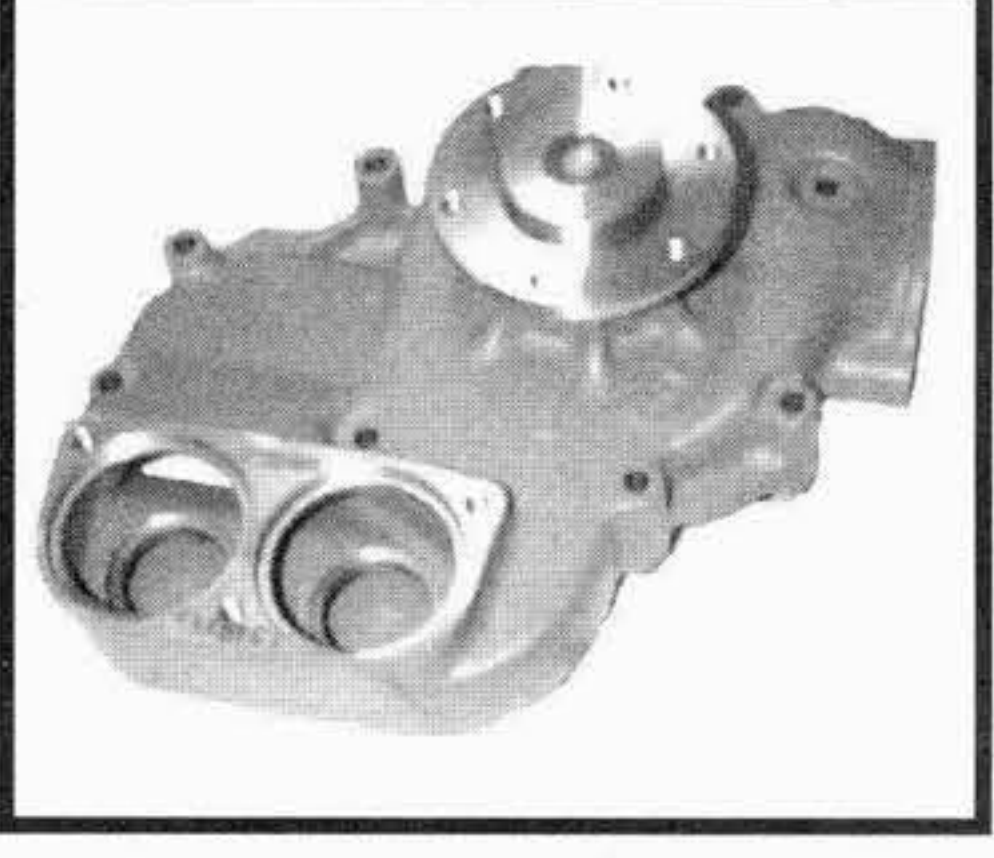
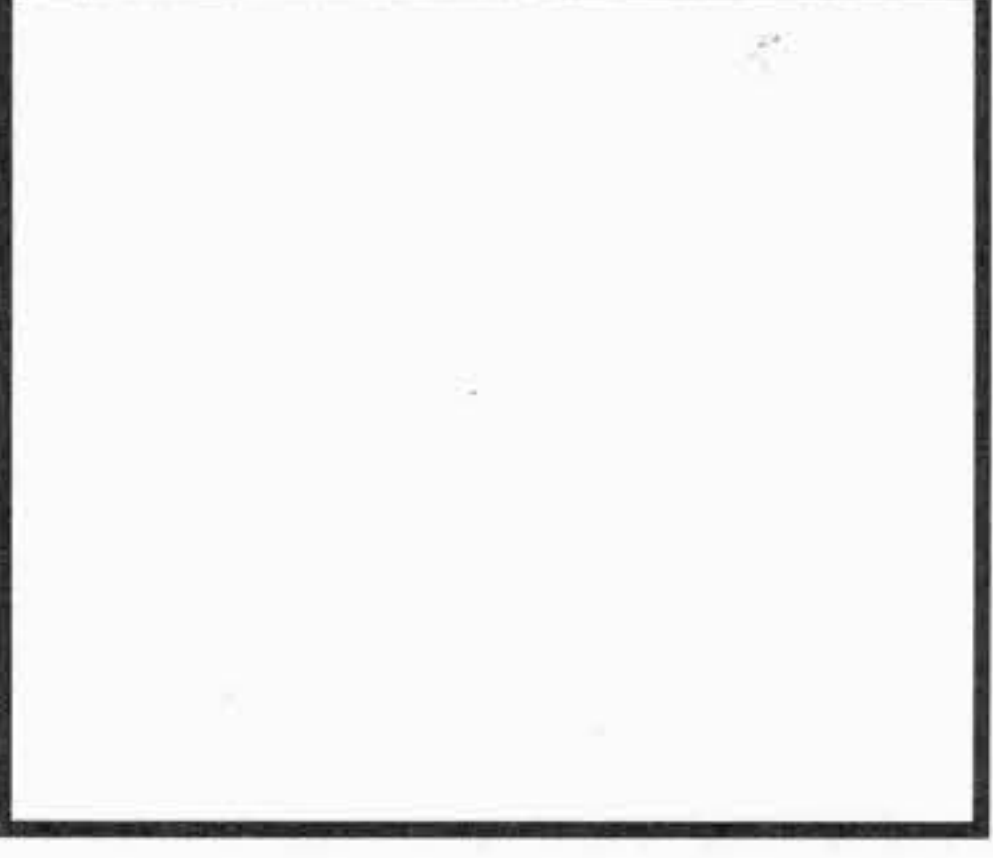
TIPO O MODELLO TYPE OU MODELE TYPE OR MODEL	MOTORE MOTEUR ENGINE	POMPA ACQUA POMPE A EAU WATER PUMP	OMP REF. / O.EM. REF	KIT RIPARAZIONE NECESSAIRE DE REP. REPAIR KIT	OMP REF. / O.EM. REF
8.192 - 13.168 F - 13.192 F 14.192 H - 20.192 D / DHR 12.168 - 14.168 - 15.168 16.168 - 19.168 15.192 - 16.192 - 22.192 13.168 HA / HAK / HK 13.240 - 15.200 - 15.240 16.240 F - 19.240 H / HA 22.192FNL/FNML - 32.232 DH / DHA 32.240 DH / DHA 16.240 H / HK / HT / HAK / HAT 16.240 FT 16.200 F - 19.200 - 22.240 24.240 FVL - 26.240 / DF - 30.240 24.192 FVL	D 2555 D 2555 M / MX D 2555 M / MX D 2555 M D 2556 M / MX D 2556 MF D 2556 MX D 2556 MXF D 2556 M / MF D2556	343.140 51.06500.6222  note : girante bassa low impeller Ø 125 mm		342.162 51.06599.6033 	
30.230 H 14.240 - 20.240 - 20.240 D 15.240 - 16.240 - 19.240 - 26.240 - 32.240 15.240 - 16.240 - 19.240 22.240 FNL - 26.240 - 30.240VF 16.256 - 19.256 - 26.256 - 30.256 - 32.256 16.280 - 20.280 FVLS - 22.280 FNL 26.280 - 30.280 VF 19.280 - 26.280 - 32.280 19.280 F / FL / FS / FT 16.320 - 19.320 - 20.320 - 26.320 - 30.320 - 32.320 16.320 - 19.320 - 30.320 - 32.320	D 2356 HMX D2566--> fino al mot. 491059 D 2566M--> fino al mot.491059 D 2566 MF --> fino al mot.491059 D2538M / MF--> fino al mot. 3581000 D 2566 MTF --> fino al mot. 3644048 D2566 MT --> fino al mot. 3644048 D2566MTL--> fino al mot.3644048 D2530 MF --> fino al mot.3358073 D2538 / MT --> fino al mot. 3581000	343.230 51.06500.6228  note : girante / impeller Ø 125 mm		342.162 51.06599.6033 	
20.320 FVLS - 22.320 FNL 14.240 - 15.240 - 16.240 - 19.240 - 20.240 - 26.240 - 32.240 15.240 - 16.240 - 19.240 - 22.240 FNL - 26.240 - 30.240VF 19.242 - 24.242 - 32.242 - 33.242 - 40.242 - 41.242 - 48.242 16.256 - 19.256 - 26.256 - 30.256 - 32.256 16.262 - 24.262 - 32.262 - 33.262 - 40.262 - 41.262 16.280 - 20.280 FVLS - 22.280 FNL - 26.280 - 30.280 VF 19.280 - 26.280 - 32.280 19.281 H - 26.281 DH 16.281 FTS - 19.281 F 20.281 FVLS - 22.281 FNL - 26.281 D - 30.281 V 16.320 - 26.320 - 30.320 - 32.320 16.320 - 30.320 - 32.320 16.321 FTS - 19.321 F - 20.321 FVLS 22.321 FNL - 26.321 D - 30.321 V - 32.321 D 19.322 - 33.322 F90 19.321 H - 26.321 - 32.321 DH 19.321 U / UL - 22.321 UNL 19.360 F - 30.360 V 19.361 F 19.362 F	D 2530 MF D 2566 / M dal mot.491060 --> D 2566 MF dal mot.491060 --> D 2866 F D2538M / MF dal mot. 3581001 --> D 2865 - D 2865 LF D2566 MTF dal mot. 3644048 --> D2566 MT dal mot. 3644049 --> D 2566 MK D 2566 MKF / 280 D 2566 MKF D2530 MF dal mot. 3358074 --> D2538 / MT dal mot. 3581001 --> D 2566 MKF D 2865 D 2566 MK D 2566 MKUL D 2530 MTXK D 2866 KFZ D 2866 KF	343.260 51.06500.6282  note : girante / impeller Ø 125 mm		342.162 51.06599.6033 	
24.292 - 32.292 - 33.292 40.292 - 41.292 - 48.292 24.332 - 32.332 - 33.332 40.332 - 41.332 - 48.332 19.343 - 33.343 F 2000 19.372 - 25.372 - 26.372 - 33.372 F90 24.362 - 32.362 - 33.362 33.362 - 40.362 - 41.362 - 48.362 33.365 19.403 - 26.403 - 33.403 - 41.403 F 2000 19.422 - 25.422 - 26.422 - 33.422 F90 32.462 - 33.462 - 40.462 - 48.462 19.463 - 26.463 - 33.463 - 41.463 F2000	D 2866 LFZ / 290 D 2866 LFZ D 2865 D 2866 D 2866 KFZ D 2866 KF D 2840 MF D 2866 D 2876 D 2540 D 2866	343.265 51.06500.6408  note : girante / impeller Ø 135 mm		342.162 51.06599.6033 	

I ricambi non sono originali ma adattabili . Ogni riferimento originale é assolutamente indicativo .

Spare parts are not original but perfectly suitable . Every original part number has to be considered for reference purpose only .

SUITABLE





MAN

AUTOCARRI - CAMIONS - TRUCKS - LKW

Tel:+44(0)1925 850082 Fax: +(0)44 1925 850083

www.spwaterpumps.co.uk

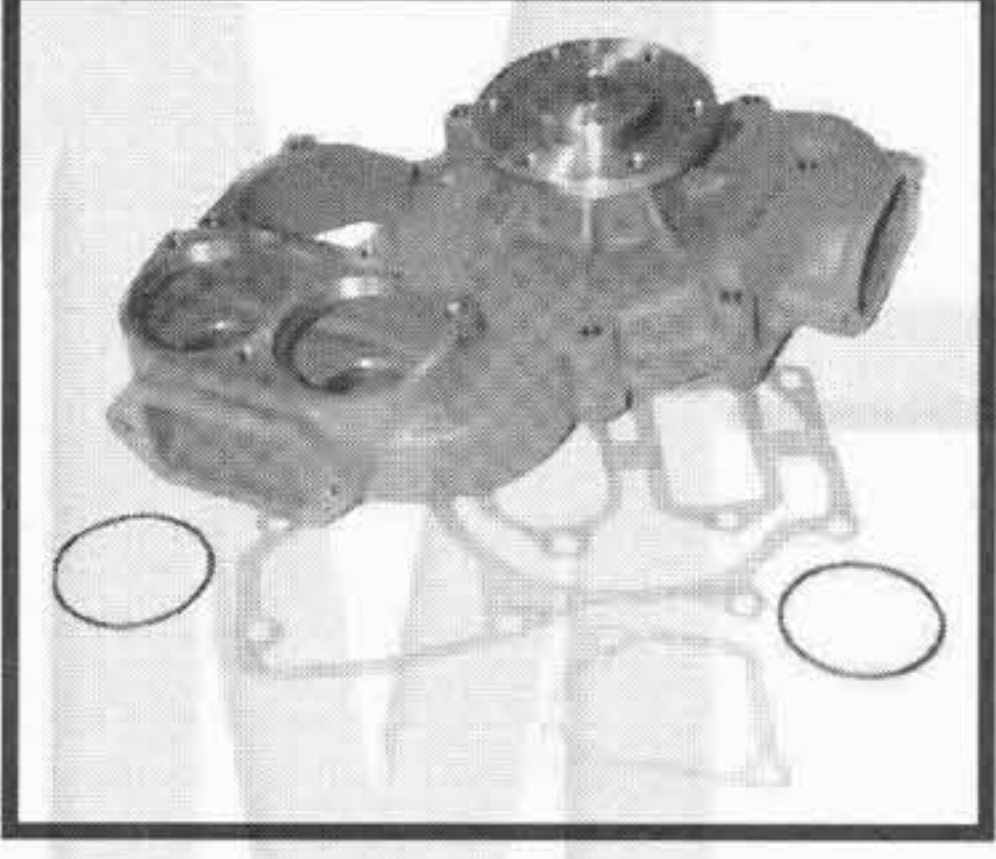
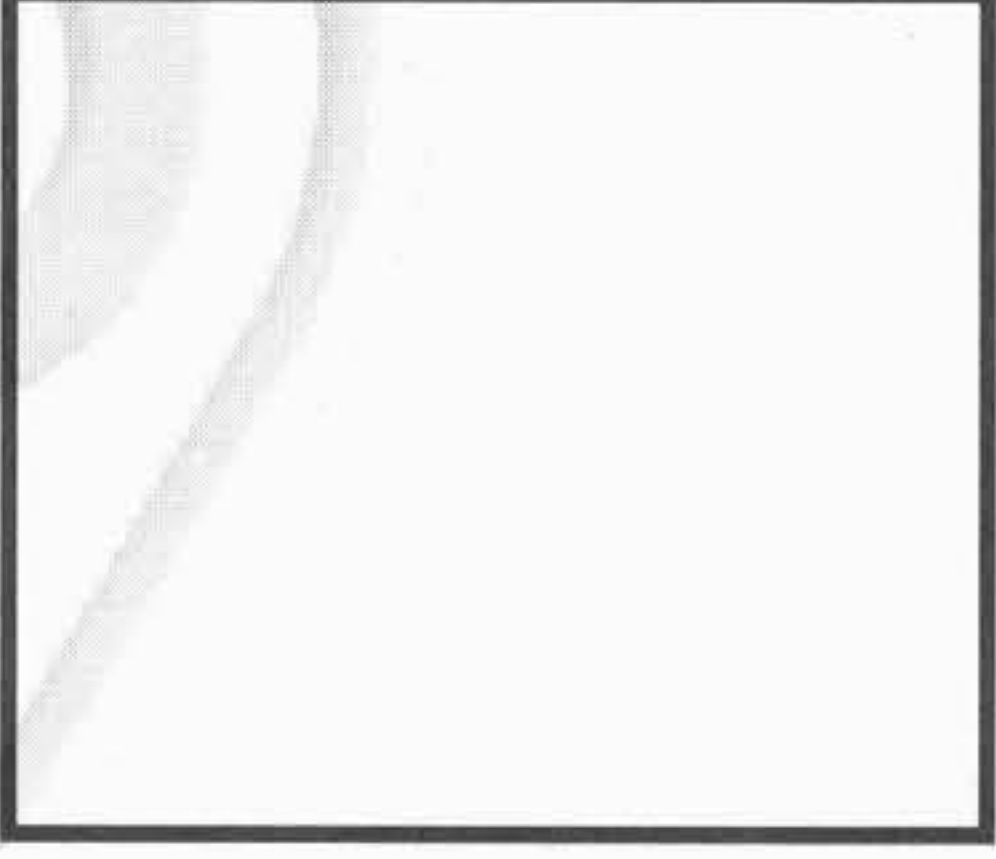
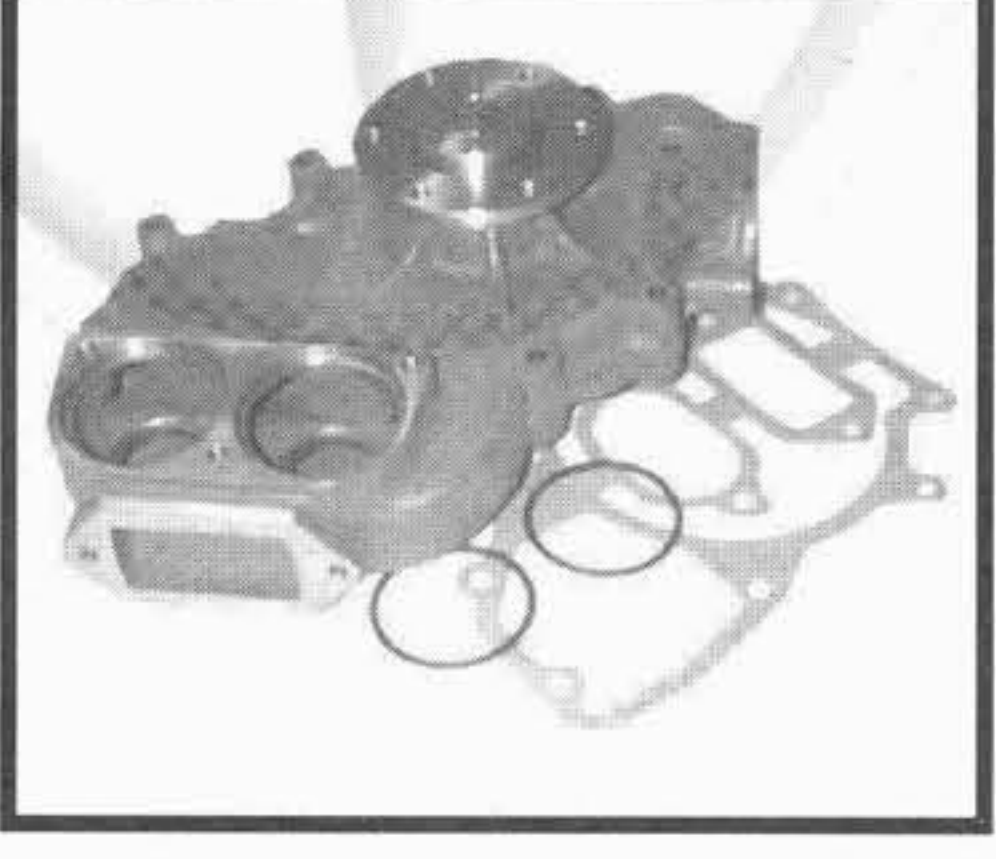

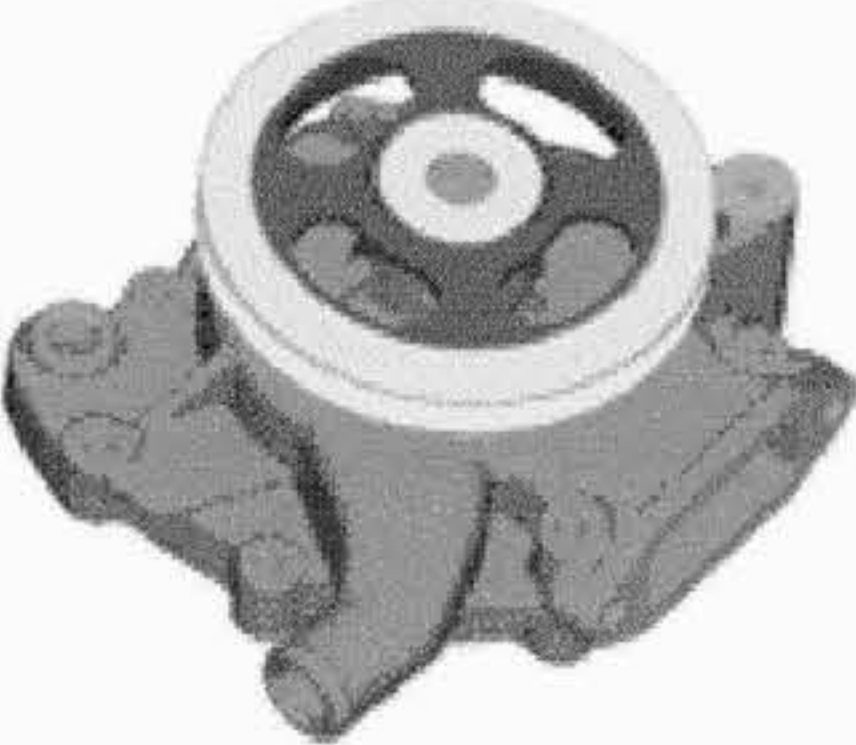
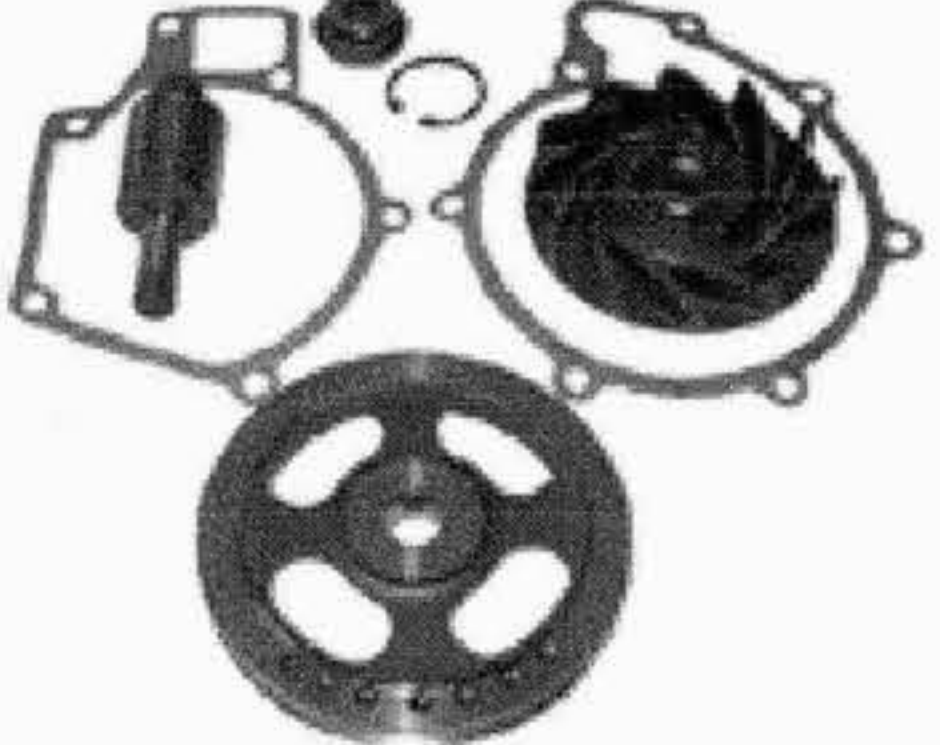
TIPO O MODELLO TYPE OU MODELE TYPE OR MODEL	MOTORE MOTEUR ENGINE	POMPA ACQUA POMPE A EAU WATER PUMP OMP REF. / O.EM. REF	KIT RIPARAZIONE NECESSAIRE DE REP. REPAIR KIT OMP REF. / O.EM. REF
<p>F 90 series</p> <p>F 2000 series</p> <p><i>tutte le versioni con pompa iniezione a comando elettronico</i></p> <p><i>all version with electronic drive injection pump</i></p>	<p>D 2865 LF 5 cyl.</p> <p>D2866LF - LXF 6 cyl.</p> <p>D2876 LF 6 cyl.</p>	<p>343.350 51.06500.6492</p> 	<p>342.162 51.06599.6033</p> 
<p>F 90 series</p> <p>F 2000 series</p> <p><i>tutte le versioni con pompa iniezione a comando elettronico + RITARDATORE</i></p> <p><i>all version with electronic drive injection pump + RETARDER</i></p>	<p>D 2865 LF 5 cyl.</p> <p>D2866LF - LXF 6 cyl.</p> <p>D2876 LF 6 cyl.</p>	<p>343.340 51.06500.6479</p> 	<p>342.162 51.06599.6033</p> 
<p>F90 Series</p> <p>19.502 - 26.502 - 33.502</p> <p>F 2000</p> <p>19.503</p> <p>19.603</p>	<p>D 2840 L</p> <p>D 2840 LF</p> <p>D2840 LF 20</p>	<p>343.345 51.06500.6426</p> 	<p>342.162 51.06599.6033</p> 
<p>11.190</p> <p>NL202F-NL222F NL252F-NL262F NL310F</p>	<p>D 0826 LUH213</p> <p>D0826LUH</p> <p>D0826LUH01- 06/08/10/12/13</p>	<p>343.360</p>  <p>O.E.M.:51.06500.6480</p>	<p>342.247</p>  <p>O.E.M.:51.06599.6055</p>

I ricambi non sono originali ma adattabili . Ogni riferimento originale é assolutamente indicativo .
Spare parts are not original but perfectly suitable . Every original part number has to be considered for reference purpose only .

SUITABLE



MAN

AUTOBUS - AUTOCARS - BUSES - OMNIBUSSE



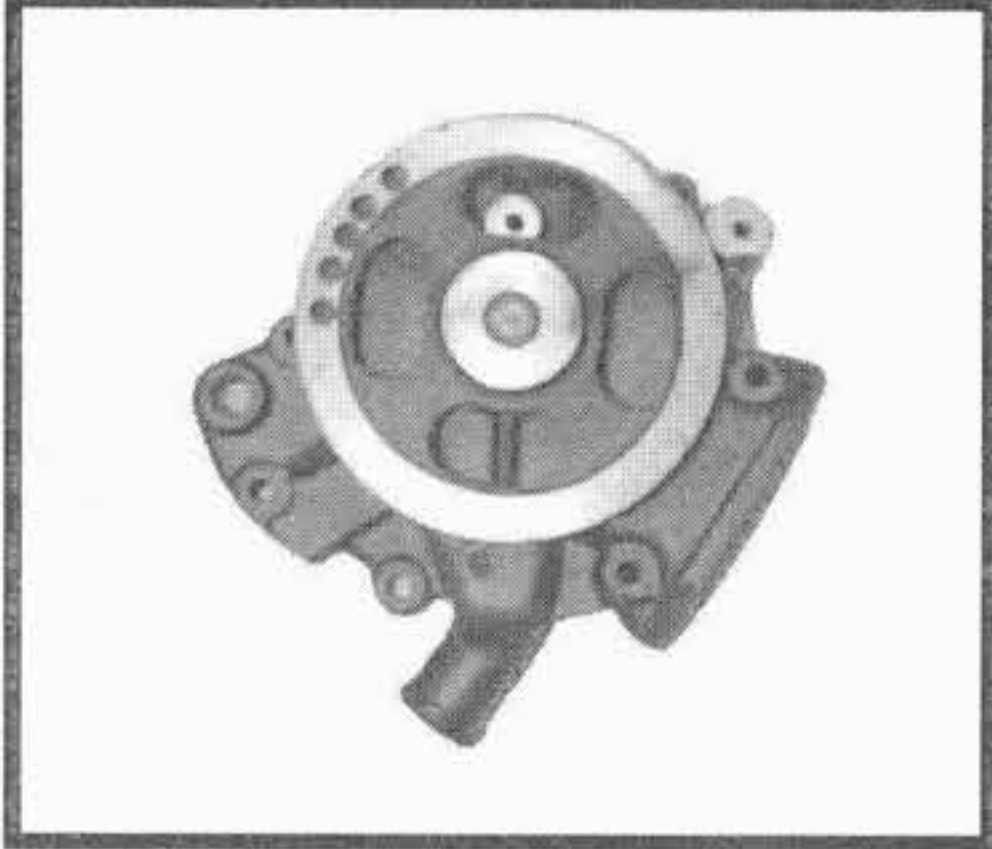
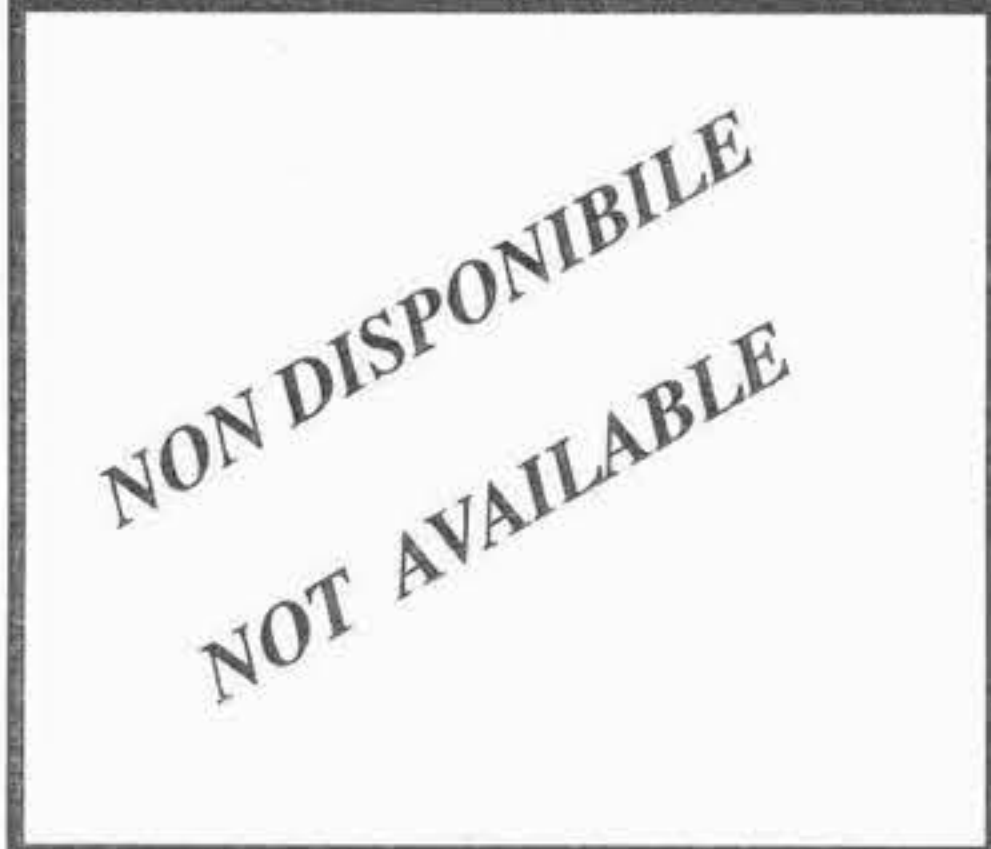

Tel:+44(0)1925 850082 Fax: +(0)44 1925 850083

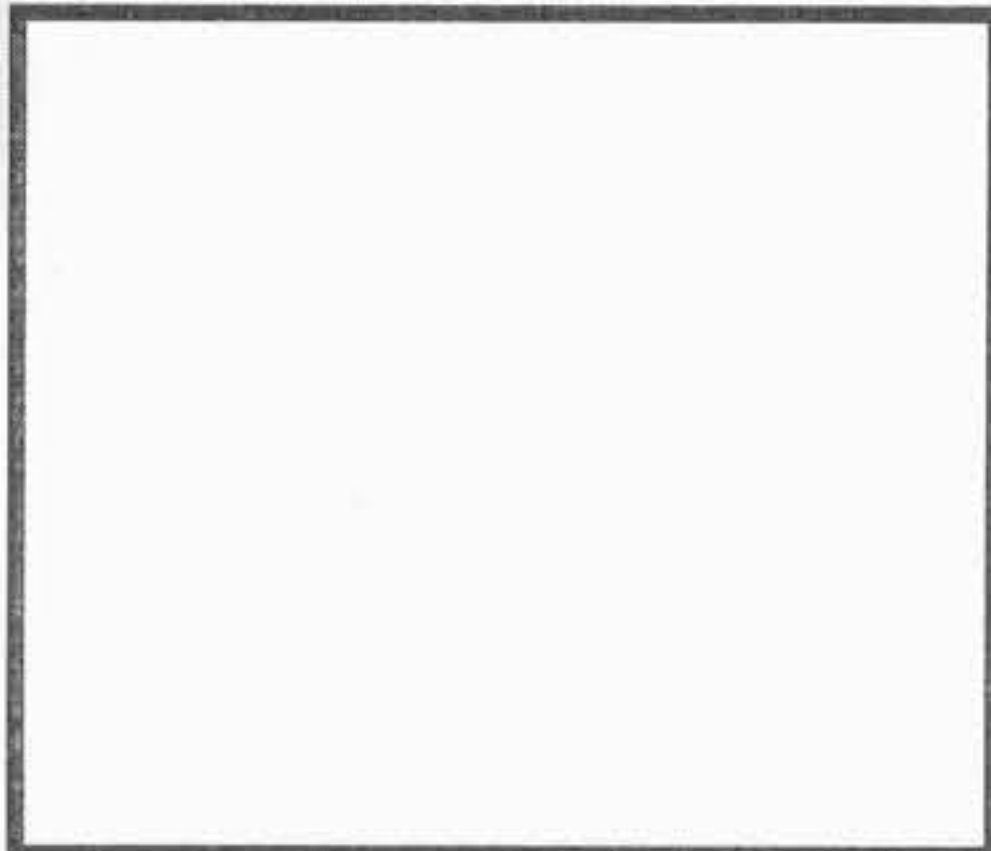
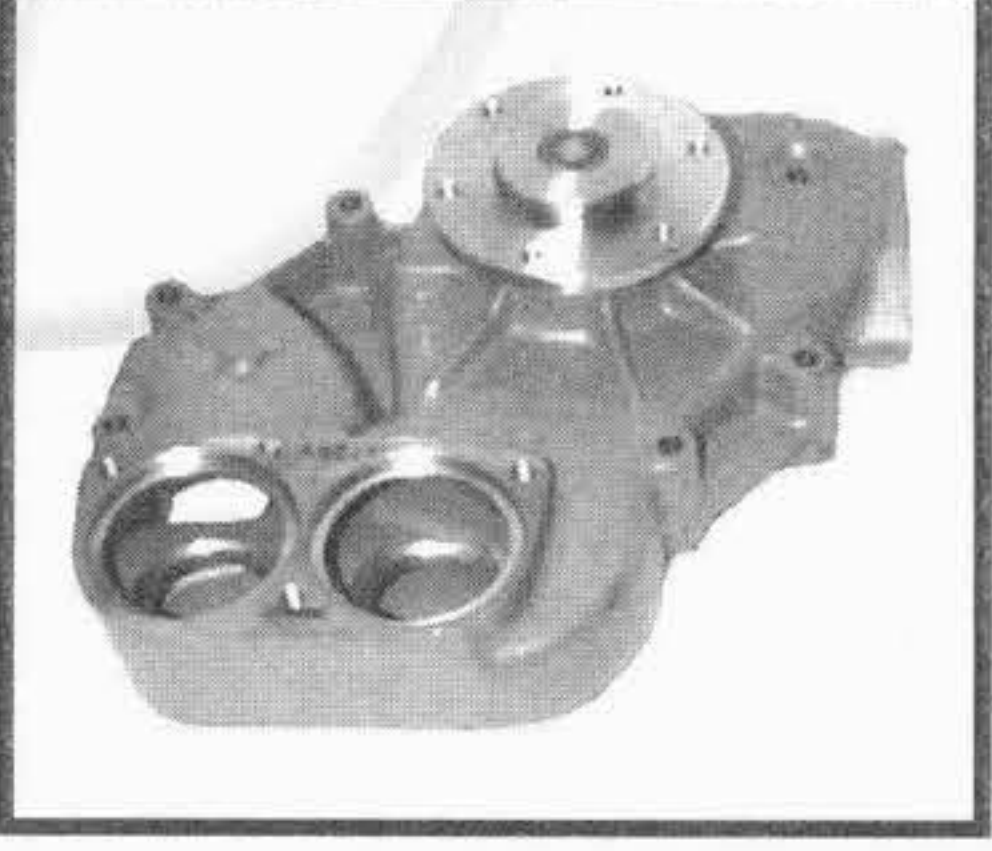
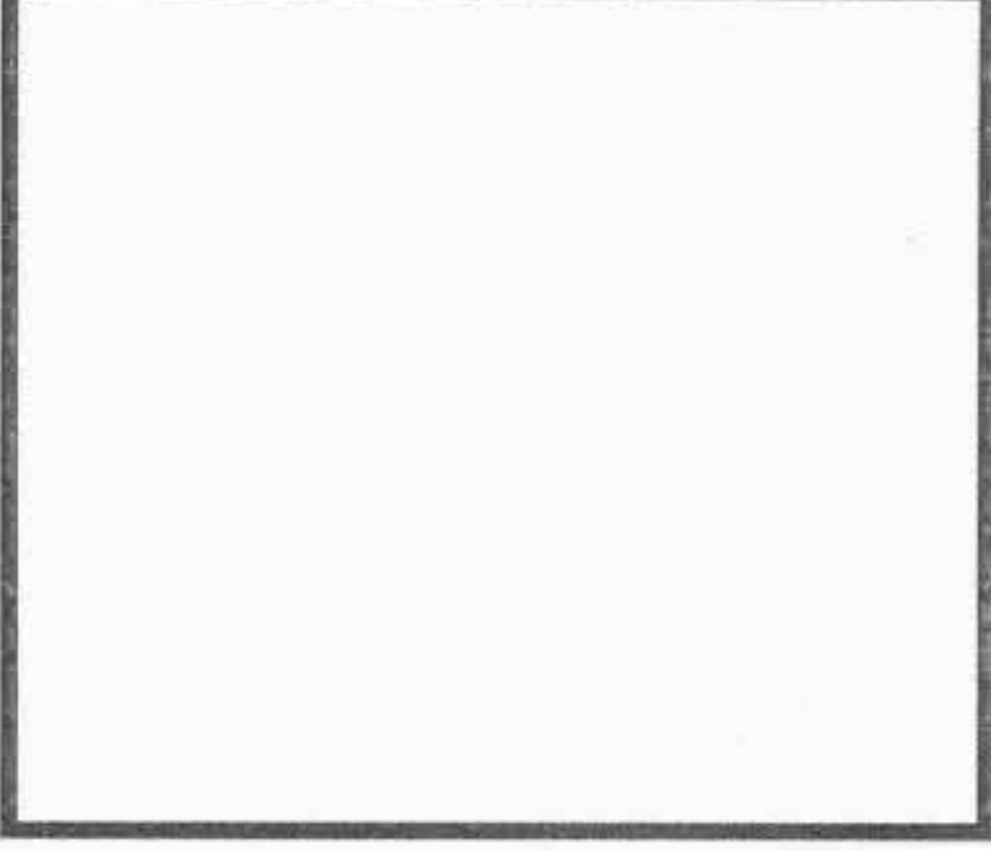
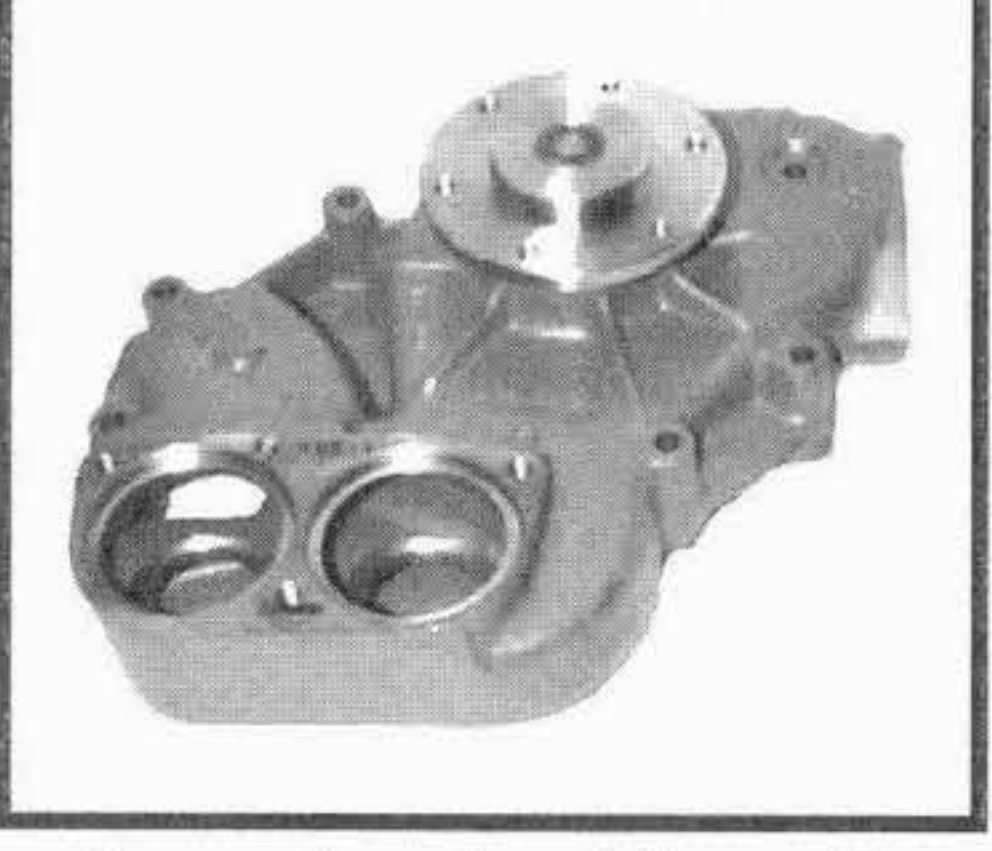
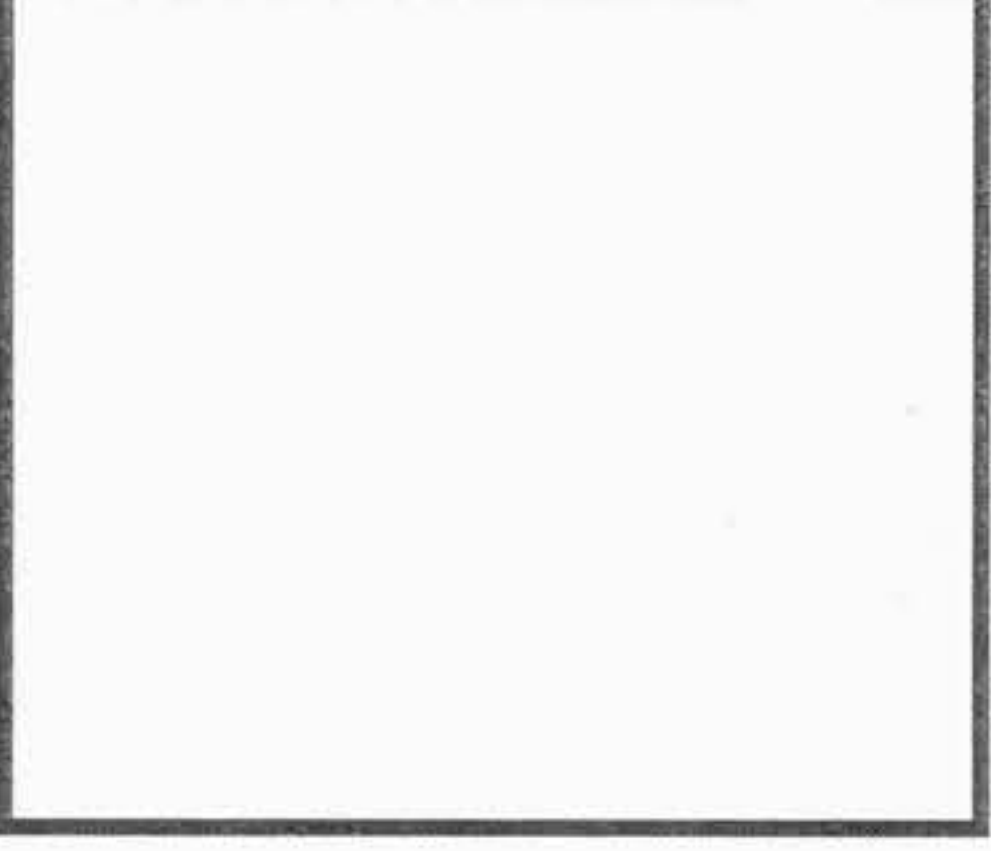
www.spwaterpumps.co.uk



TIPO O MODELLO TYPE OU MODELE TYPE OR MODEL	MOTORE MOTEUR ENGINE	POMPA ACQUA POMPE A EAU WATER PUMP OMP REF. / O.EM. REF	KIT RIPARAZIONE NECESSAIRE DE REP. REPAIR KIT OMP REF. / O.EM. REF
11.190 NL 202 F	D 0826 LUH 213	343.330 51.06500.6543 	
750 HO	D 0836 HMU	- 51.06500.6200 con basamento / with housing  343.050 --- senza basamento / without housing	342.109 51.06599.6002  343.021 51.06505.6042 albero completo / complete shaft
SG 192 SD 200 SL 200 SL 200 SG 220 - SUE 224 SUE 240 - SR 240	D 2556 HMXU D 2556 D 2556 MX D 2556 HXUH D2556	343.140 51.06500.6222  note : girante bassa low impeller Ø 125 mm	342.162 51.06599.6033 
SG 192 - SL 200 - SUE 240 SR 240 - SR 280 SR 240 - SR 280 SR 280 FRH - SG 280	D 2566MUH ---> fino al motore 4091102 D 2566MTUH ---> fino al motore 4077098	343.230 51.06500.6228  note : girante / impeller Ø 125 mm	342.162 51.06599.6033 

I ricambi non sono originali ma adattabili . Ogni riferimento originale é assolutamente indicativo .
 Spare parts are not original but perfectly suitable . Every original part number has to be considered for reference purpose only .

TYPE OR MODEL	ENGINE	WATER PUMP	REPAIR KIT
<p>L 2000 Series 6.103, 6.1123, 8.153 9.153, 10.153</p> <p>M 2000 Series 11.153</p> <p>8.125 STAR 8.155 STAR NM152 Midi Bus BREDA MENARINI BUS 230</p>	<p>DO824 FL DO824 LFL DO824 LFL 01/04/05/08-10</p> <p>DO824LFL 09/10 STAR DO824 LOH 01/02/05 DO826 LFL 03/06/10 DO826 LFL 10</p>	<p>343.355</p>  <p>IMPELLER SET BEHIND GASKET FACE</p> <p>51.06500.6515</p>	<p>342.244</p>  <p>51.06599.6060</p>
<p>L 2000 Series 8.163, 9.163, 10.163 M 2000 Series 11.163</p>	<p>D0824 LFL 02/06/07 DO824 LFL 06 135 mm Impeller</p>	<p>343.365</p>  <p>51.06500.6537</p>	<p>342.246</p>  <p>51.06599.6067</p>
<p>F 2000 Series Fixed Pulley All Versions with Electric Drive Injection Pump EDC MANUAL GEARBOX WITHOUT RETARDER</p>	<p>D 2865 LF 5 CYL D 2866 LF, LXF 6 CYL D 2976 LF 6 CYL</p>	<p>343.370</p>  <p>51.06500.6437</p>	
<p>F 2000 Series Fixed Pulley All Versions with Electric Drive Injection Pump EDC MANUAL GEARBOX WITH RETARDER</p>	<p>D 2865 LF 5 CYL D 2866 LF - LXF 6 CYL D 2876 LF 6 CYL Retarder Flange →</p>	<p>343.375</p>  <p>51.06500.6546</p>	

TYPE OR MODEL	ENGINE	WATER PUMP	REPAIR KIT
<p>5106 500 3235 5106 500 6612 5106 500 6606 5106 500 6575 5106 500 3235</p> <p>LOH 15/17/18 LF 15/17/18 LFL 01/02/03/05</p> <p>18.220</p>	<p>D0826 D0834 D0836</p> <p>Raised Lug Additional Mounting Hole</p> <p>125mm Impeller</p>	<p>SP1683</p>  <p>5106 500 3235</p>	
<p>MAN TGA 18 480 18 510, 18 530, 24,480, 26 510, 26 530, 32 480 33 480, 33 510, 33 530,</p> <p>51 06500 7045 51 06500 7047 51 06500 7048 51 06599 7065 51 06500 7066 51 06500 9048 51 06500 9052</p>	<p>MAN TGA 18 363 ECT</p> <p>D2876 LF05 D2876 LF13 D2876 LF12</p>	<p>SP1682</p>  <p>5106 500 9066</p>	
<p>MAN TGA D20 COMMON—RAIL</p>	<p>D 2066 D 2076</p> <p>235/320 235/360 235/400 324/440 353/480 397/540</p>	<p>SP1684</p>  <p>5106 500 7049</p>	



Tel: +(0)44 1925 850082 Fax: +(0)44 1925 850083
www.spwaterpumps.co.uk

TYPE OR MODEL	ENGINE	WATER PUMP	REPAIR KIT



SECTION 33

APPLICATION

MERCEDES

BENZ

**WATER PUMPS WASSERPUMPEN
POMPE A EAU BOMBA DE AGUA
POMPA ACQUA**

S.P. WATER PUMPS LTD
18 Tatton Court, Kingsland Grange, Woolston,
Warrington, Cheshire. ENGLAND. WAI 4RR
TEL: +44(0) 1925 850082 Fax: +44(0) 1925 850083
Email:sales@spwaterpumps.co.uk Web Site:www.spwaterpumps.co.uk

TAVOLE DI CONVERSIONE
TABLE DE CONVERSION
CONVERSION TABLE

MERCEDES BENZ



NUMERO ORIGINALE NUMERO ORIGINAL ORIGINAL NUMBER	NUMERO SOSTITUTIVO REPLACE PAR NUMERO REPLACED BY NUMBER	RIFERIMENTO OMP REFERENCE OMP OMP REFERENCE
000.201.00.63		241.805
000.201.01.97	VEDI 241.805	241.853
000.201.04.63	VEDI 241.805	244.004
000.201.27.19		241.784
000.201.32.19	000.201.37.19	
000.201.37.19	000.201.61.19	
000.201.57.19	000.201.67.19	
000.201.61.19	000.201.66.19	
000.201.65.19	000.201.68.19	
000.201.66.19	000.201.72.19	
000.201.67.19	000.201.72.19	
000.201.68.19	000.201.69.19	
000.201.69.19	000.201.71.19	
000.201.71.19	000.201.73.19	
000.201.72.19		241.815
000.201.73.19	000.201.80.19	
000.201.80.19		241.857
000.997.19.88		241.774
000.997.75.47		241.770
000.997.77.47		241.769
001.981.96.01		241.810
002.997.84.46	=005.997.01.47	241.812
003.997.51.46	=005.997.00.47	241.811
003.997.57.48		241.798
005.997.00.47	=003.997.51.46	241.811
005.997.01.47	=002.997.84.46	241.812
005.997.11.45		241.813
011.997.70.48		241.912
304.357.01.21		241.838
314.200.00.60	314.200.40.01	
314.200.01.04	314.200.06.04	
314.200.01.60		242.222
314.200.03.04	314.200.04.04	
314.200.04.04	314.200.07.04	
314.200.05.04	314.200.08.04	
314.200.06.01	314.200.08.01	
314.200.06.04	314.200.09.04	
314.200.07.04	314.200.10.04	
314.200.08.01	314.200.19.01	
314.200.08.04	314.200.11.04	
314.200.09.04		242.223
314.200.10.04		242.224
314.200.11.04		242.225
314.200.19.01	314.200.21.01	
314.200.21.01	314.200.24.01	
314.200.24.01	314.200.29.01	
314.200.29.01	314.200.37.01	

NUMERO ORIGINALE NUMERO ORIGINAL ORIGINAL NUMBER	NUMERO SOSTITUTIVO REPLACE PAR NUMERO REPLACED BY NUMBER	RIFERIMENTO OMP REFERENCE OMP OMP REFERENCE
314.200.35.01	314.200.41.01	
314.200.37.01	314.200.39.01	
314.200.39.01	314.200.42.01	
314.200.40.01		242.202
314.200.41.01	314.200.47.01	
314.200.42.01		241.900
314.200.47.01		241.930
314.201.00.07	364.200.06.04	241.934
314.201.05.01		241.931
314.586.00.20	314.200.00.60	
314.586.01.20	314.200.01.04	
315.201.01.02		241.762
315.201.01.51		241.766
315.201.01.80		241.775
315.201.02.05		241.764
315.201.03.03		241.782
315.202.00.08		241.763
321.200.04.01	352.200.23.01	
322.200.02.03	352.200.15.01	
322.200.08.01	352.200.23.01	
326.200.02.01	326.200.09.01	
326.200.07.01	346.200.04.01	
326.200.09.01	346.200.04.01	
326.200.13.01	346.200.04.01	
327.200.00.60	360.200.44.01	
327.201.01.05		241.737
327.201.07.80		241.899
327.203.01.80		241.742
327.203.03.80	352.203.04.80	
329.200.00.20		241.915
345.200.71.01		241.955
346.200.00.01	355.200.00.01	
346.200.00.04		242.074
346.200.01.04		242.195
346.200.02.01	355.200.00.01	
346.200.04.01	346.200.11.01	
346.200.10.01		241.845
346.200.11.01		241.780
346.200.12.01		242.064
346.201.00.07		241.785
346.201.02.01		241.781
346.201.05.07		241.863
346.586.00.20	346.200.12.01	
346.586.02.20	346.200.00.04	
346.586.03.20	346.200.01.04	
352.200.02.60	352.200.05.60	
352.200.04.60	353.200.30.01	

OGNI RIFERIMENTO ORIGINALE E' ASSOLUTAMENTE INDICATIVO. CHAQUE REFERENCE ORIGINAL EST ABSOLUMENT INDICATIVE. EVERY ORIGINAL PART NUMBER HAS TO BE CONSIDERED FOR REFERENCE PURPOSE ONLY.

TAVOLE DI CONVERSIONE
TABLE DE CONVERSION
CONVERSION TABLE

MERCEDES BENZ



NUMERO ORIGINALE NUMERO ORIGINAL ORIGINAL NUMBER	NUMERO SOSTITUTIVO REPLACE PAR NUMERO REPLACED BY NUMBER	RIFERIMENTO OMP REFERENCE OMP OMP REFERENCE
352.200.05.60	353.200.31.01	
352.200.06.04	352.200.08.04	
352.200.06.60	353.200.25.01	
352.200.07.04	352.200.08.04	
352.200.08.04	352.200.09.04	
352.200.08.60	353.200.24.01	
352.200.09.04	352.200.10.04	
352.200.09.60		242.227
352.200.10.04	352.200.19.04	
352.200.10.60	353.200.26.01	
352.200.13.04	352.200.28.04	
352.200.14.04	352.200.29.04	
352.200.15.01	352.200.20.01	
352.200.15.04	352.200.30.04	
352.200.16.04	352.200.31.04	
352.200.17.04	352.200.32.04	
352.200.19.04	352.200.33.04	
352.200.20.01	352.200.23.01	
352.200.23.01	352.200.93.01	
352.200.23.04	352.200.34.04	
352.200.24.04	352.200.35.04	
352.200.25.04	352.200.36.04	
352.200.28.04	352.200.38.04	
352.200.29.04	352.200.39.04	
352.200.30.04	352.200.40.04	
352.200.31.04	352.200.41.04	
352.200.32.04	352.200.42.04	
352.200.33.04	352.200.43.04	
352.200.34.01	352.200.54.01	
352.200.34.04	352.200.44.04	
352.200.35.04	352.200.45.04	
352.200.36.04	352.200.46.04	
352.200.38.01	352.200.94.01	
352.200.38.04		242.191
352.200.39.01	352.200.94.01	
352.200.39.04		242.205
352.200.40.04		242.164
352.200.41.04		242.215
352.200.42.04		242.146
352.200.43.04		242.228
352.200.44.04		242.229
352.200.45.04		242.230
352.200.46.04		
352.200.49.01	352.200.84.01	
352.200.54.01	352.200.95.01	
352.200.72.01	352.200.85.01	
352.200.74.01	352.200.84.01	

NUMERO ORIGINALE NUMERO ORIGINAL ORIGINAL NUMBER	NUMERO SOSTITUTIVO REPLACE PAR NUMERO REPLACED BY NUMBER	RIFERIMENTO OMP REFERENCE OMP OMP REFERENCE
352.200.75.01	352.200.85.01	
352.200.81.01	352.200.95.01	
352.200.84.01	353.200.04.01	
352.200.85.01	352.200.92.01	
352.200.86.01	353.200.19.01	
352.200.87.01	353.200.15.01	
352.200.89.01	352.200.96.01	
352.200.92.01	352.200.97.01	
352.200.93.01	353.200.40.01	
352.200.94.01	353.200.03.01	
352.200.95.01	352.200.96.01	
352.200.96.01	353.200.16.01	
352.200.97.01	353.200.17.01	
352.201.00.12		241.797
352.201.00.39		241.792
352.201.00.58	352.201.02.58	
352.201.01.05		241.802
352.201.01.07		241.793
352.201.02.01		241.777
352.201.02.58	352.201.05.58	
352.201.03.01		241.747
352.201.04.80		241.778
352.201.05.07	366.200.02.04	241.847
352.201.05.58		241.848
352.201.05.80		241.789
352.201.06.01		241.744
352.201.06.05		241.746
352.201.06.80		241.897
352.201.08.03	352.201.09.03	
352.201.08.80		241.854
352.201.09.03		241.779
352.201.10.01		241.843
352.201.10.80		241.898
352.201.11.80	352.201.12.80	
352.201.12.80		241.851
352.201.13.03	352.201.18.03	
352.201.14.03		
352.201.15.03		241.748
352.201.16.03		241.844
352.201.17.01		241.756
352.201.17.03		241.757
352.201.18.03		241.937
352.201.19.01		241.936
352.201.19.03		241.942
352.201.20.03		241.939
352.201.21.01		241.941
352.201.22.01		241.938

OGNI RIFERIMENTO ORIGINALE E' ASSOLUTAMENTE INDICATIVO. CHAQUE REFERENCE ORIGINAL EST ABSOLUMENT INDICATIVE. EVERY ORIGINAL PART NUMBER HAS TO BE CONSIDERED FOR REFERENCE PURPOSE ONLY.

TAVOLE DI CONVERSIONE
TABLE DE CONVERSION
CONVERSION TABLE

MERCEDES BENZ



NUMERO ORIGINALE NUMERO ORIGINAL ORIGINAL NUMBER	NUMERO SOSTITUTIVO REPLACE PAR NUMERO REPLACED BY NUMBER	RIFERIMENTO OMP REFERENCE OMP OMP REFERENCE
352.203.04.80		241.796
352.203.07.80	352.203.16.80	
352.203.16.80		241.909
352.586.00.20	353.200.42.01	
352.586.02.20	352.200.04.60	
352.586.03.20	352.200.02.60	
352.586.04.20	352.586.05.20	
352.586.05.20	352.200.02.60	
352.586.06.20	352.200.13.04	
352.586.07.20	352.200.14.04	
352.586.08.20	353.200.00.04	
352.586.10.20	352.200.06.60	
352.586.11.20	352.200.15.04	
352.586.12.20	352.200.16.04	
352.586.15.20	352.200.17.04	
353.200.02.01	353.200.05.01	
353.200.03.01	353.200.21.01	
353.200.04.01	353.200.36.01	
353.200.05.01	353.200.20.01	
353.200.15.01	314.200.37.01	
353.200.16.01	353.200.17.01	
353.200.17.01	353.200.38.01	
353.200.19.01	353.200.39.01	
353.200.20.01		241.990
353.200.21.01	353.200.37.01	
353.200.24.01		242.226
353.200.25.01		242.188
353.200.30.01		242.204
353.200.31.01		242.196
353.200.36.01	353.200.37.01	
353.200.37.01		241.935
353.200.38.01	353.200.56.01	
353.200.39.01		241.945
353.200.40.01		241.790
353.200.42.01		
353.200.56.01		241.940
355.200.00.01		241.760
355.200.00.60		242.067
355.200.01.01	355.200.08.01	
355.200.01.60	355.200.13.01	
355.200.02.01	345.200.71.01	
355.200.02.60	355.200.14.01	
355.200.04.04	355.200.09.04	
355.200.05.01	355.200.09.01	
355.200.06.01	355.200.08.01	
355.200.05.04		242.075
355.200.07.04	355.200.10.04	

NUMERO ORIGINALE NUMERO ORIGINAL ORIGINAL NUMBER	NUMERO SOSTITUTIVO REPLACE PAR NUMERO REPLACED BY NUMBER	RIFERIMENTO OMP REFERENCE OMP OMP REFERENCE
355.200.08.01	355.200.09.01	241.800
355.200.08.04	355.200.12.04	
355.200.09.01	355.200.11.01	241.890
355.200.09.04	355.200.13.04	
355.200.10.04	355.200.14.04	
355.200.11.01	355.200.15.01	
355.200.12.04		242.212
355.200.13.01		242.065
355.200.13.04		242.076
355.200.14.01		242.211
355.200.14.04		242.161
355.200.15.01		241.905
355.201.00.01		241.761
355.201.00.07		241.765
355.201.00.39		241.907
355.201.00.72		241.808
255.201.00.80		241.864
355.201.01.01		241.801
355.201.01.07		241.892
355.201.02.07		241.903
355.201.03.01		241.891
355.201.04.01		241.904
355.586.00.20	355.200.00.60	
355.586.01.20	355.200.01.60	
355.586.02.20	355.200.04.04	
355.586.03.20	355.200.05.04	
355.586.06.20	355.200.07.04	
356.201.00.07		241.803
356.201.00.39		241.807
356.201.01.80		241.864
360.200.00.60	360.200.43.01	
360.200.01.01	360.200.16.01	
360.200.01.04	360.200.05.04	
360.200.01.60	360.200.41.01	
360.200.02.60	360.200.42.01	
360.200.03.01	360.200.09.01	
360.200.03.04	360.200.06.04	
360.200.04.04	360.200.05.04	
360.200.05.04	360.200.07.04	
360.200.06.04		242.071
360.200.07.04		242.058
360.200.09.01	360.200.37.01	
360.200.11.01	360.200.17.01	
360.200.16.01	360.200.32.01	
360.200.17.01	360.200.38.01	
360.200.23.01	360.200.38.01	
360.200.32.01	360.200.38.01	

OGNI RIFERIMENTO ORIGINALE E' ASSOLUTAMENTE INDICATIVO. CHAQUE REFERENCE ORIGINAL EST ABSOLUMENT INDICATIVE. EVERY ORIGINAL PART NUMBER HAS TO BE CONSIDERED FOR REFERENCE PURPOSE ONLY.

TAVOLE DI CONVERSIONE
TABLE DE CONVERSION
CONVERSION TABLE

MERCEDES BENZ



NUMERO ORIGINALE NUMERO ORIGINAL ORIGINAL NUMBER	NUMERO SOSTITUTIVO REPLACE PAR NUMERO REPLACED BY NUMBER	RIFERIMENTO OMP REFERENCE OMP OMP REFERENCE
360.200.37.01	360.200.45.01	
360.200.38.01	360.200.46.01	
360.200.41.01	360.200.42.01	
360.200.42.01		242.057
360.200.44.01		
360.200.45.01		241.735
360.200.46.01		241.740
360.201.00.05		241.738
360.201.01.07		241.739
360.201.01.80		241.743
360.201.04.01		241.741
360.201.05.01		241.736
360.586.01.20	360.586.02.20	
360.586.02.20	360.200.01.60	
360.586.03.20	360.200.01.04	
360.586.05.20	360.200.03.04	
360.586.06.20	360.200.04.04	
364.200.00.60	364.200.18.01	
364.200.01.01	364.200.09.01	
364.200.02.04	364.200.03.04	
364.200.03.04	364.200.05.04	
364.200.05.04	364.200.08.04	
364.200.06.04		241.948
364.200.08.04		242.248
364.200.09.01	364.200.20.01	
364.200.18.01		242.231
364.200.20.01		241.965
364.201.00.01		241.921
366.200.00.04	366.200.03.04	
366.200.00.60	366.200.40.01	
366.200.02.04		241.949
366.200.03.04	366.200.06.04	
366.200.04.01	366.200.09.01	
366.200.04.04	366.200.07.04	
366.200.05.01	366.200.15.01	
366.200.05.04	366.200.09.04	
366.200.06.04	366.200.08.04	
366.200.07.04	366.200.09.04	
366.200.08.04		242.249
366.200.09.01	366.200.59.01	
366.200.09.04		
366.200.15.01	366.200.60.01	
366.200.19.01	366.200.61.01	
366.200.22.01	366.200.15.01	
366.200.25.01	366.200.62.01	
366.200.26.01	366.200.41.01	
366.200.40.01		

NUMERO ORIGINALE NUMERO ORIGINAL ORIGINAL NUMBER	NUMERO SOSTITUTIVO REPLACE PAR NUMERO REPLACED BY NUMBER	RIFERIMENTO OMP REFERENCE OMP OMP REFERENCE
366.200.59.01		241.975
366.200.60.01		241.985
366.200.61.01		
366.200.62.01		
366.201.02.01		241.911
366.202.00.80		241.913
390.200.00.01		
403.200.02.60	403.200.69.01	
403.200.04.02	403.200.07.02	
403.200.06.01	403.200.36.01	
403.200.07.02	403.200.09.02	
403.200.09.02	403.200.10.02	
403.200.10.01	403.200.36.01	
403.200.10.02	403.200.15.02	
403.200.15.02		241.837
403.200.17.02	403.200.18.02	
403.200.18.02	403.200.19.02	
403.200.19.02		241.906
403.200.22.01	403.200.39.01	
403.200.24.01	403.200.49.01	
403.200.25.01	403.200.49.01	
403.200.27.01	403.200.35.01	
403.200.32.01	403.200.35.01	
403.200.34.01	403.200.35.01	
403.200.35.01	403.200.49.01	
403.200.36.01	403.200.39.01	
403.200.37.01	403.200.52.01	
403.200.39.01	403.200.50.01	
403.200.44.01	403.200.51.01	
403.200.46.01	403.200.58.01	
403.200.47.01	403.200.53.01	
403.200.49.01	403.200.70.01	
403.200.50.01		241.830
403.200.51.01	403.200.71.01	
403.200.52.01	403.200.72.01	
403.200.53.01	403.200.73.01	
403.200.58.01	403.200.74.01	
403.200.59.01	403.200.53.01	
403.200.64.01	403.200.75.01	
403.200.69.01	422.200.09.01	
403.200.70.01		241.825
403.200.71.01		241.835
403.200.72.01		241.840
403.200.73.01		241.895
403.200.74.01		241.950
403.200.75.01		
403.200.76.01		

OGNI RIFERIMENTO ORIGINALE E' ASSOLUTAMENTE INDICATIVO. CHAQUE REFERENCE ORIGINAL EST ABSOLUMENT INDICATIVE. EVERY ORIGINAL PART NUMBER HAS TO BE CONSIDERED FOR REFERENCE PURPOSE ONLY.

SUITABLE

MERCEDES BENZ AUTOCARRI - CAMIONS - TRUCKS

Tel: +44(0)1925 850082 Fax: +(0)44 1925 850083

www.spwaterpumps.co.uk

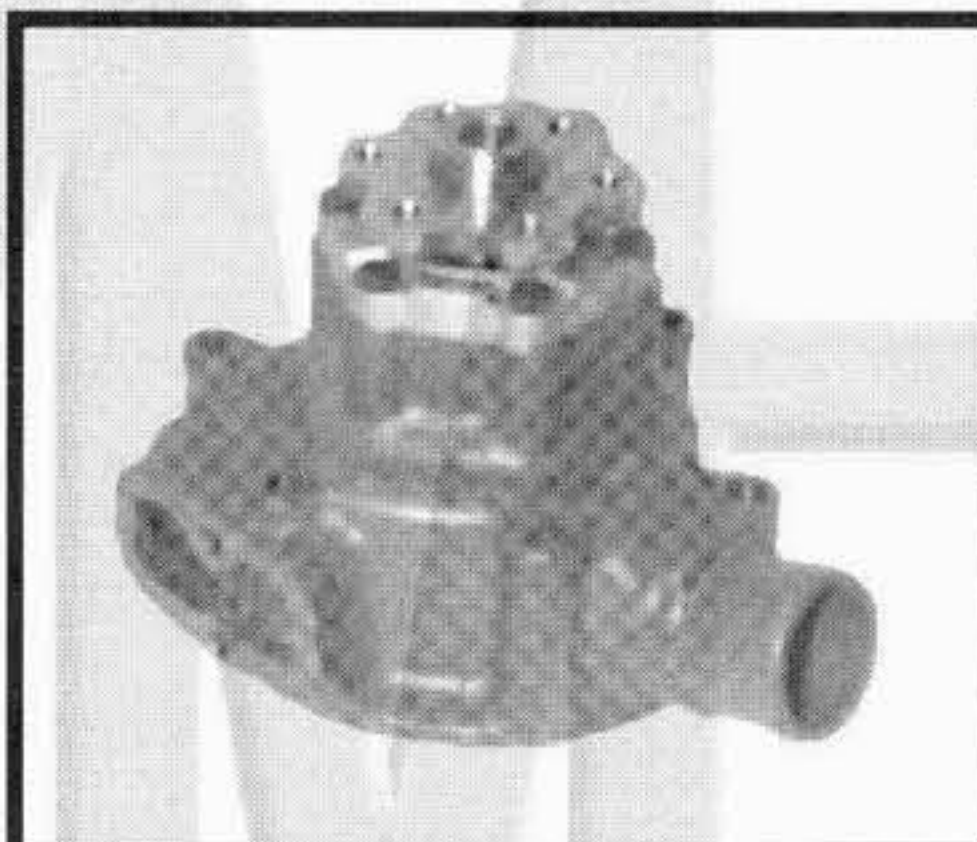
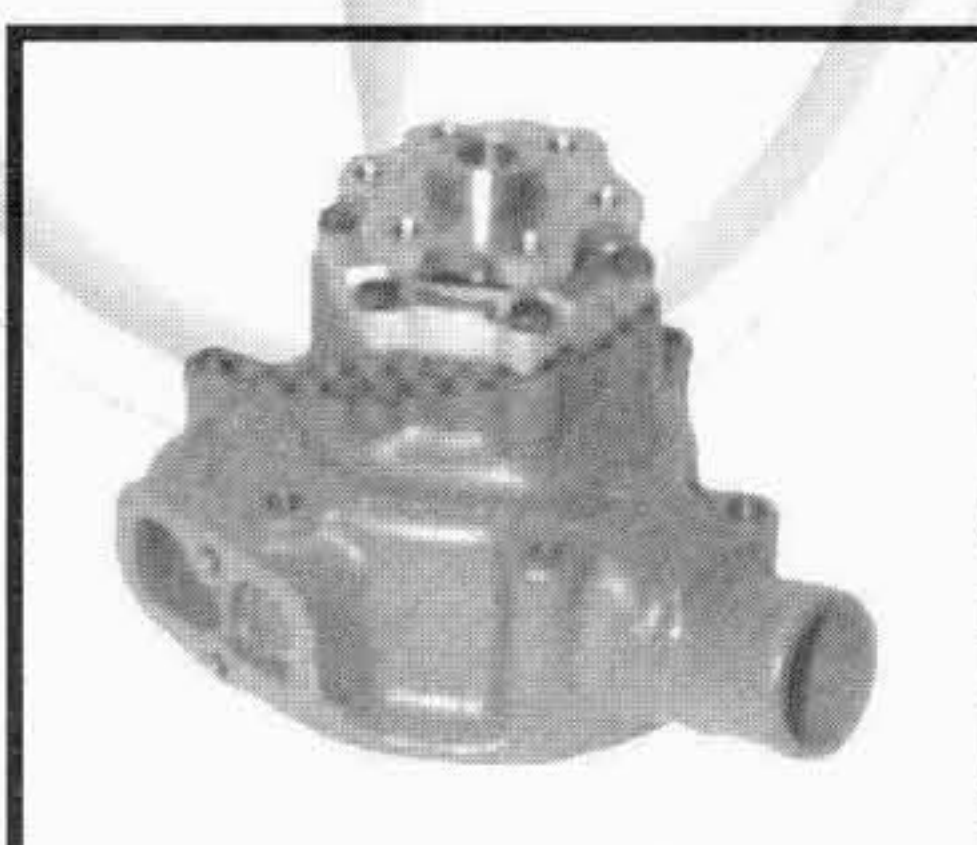
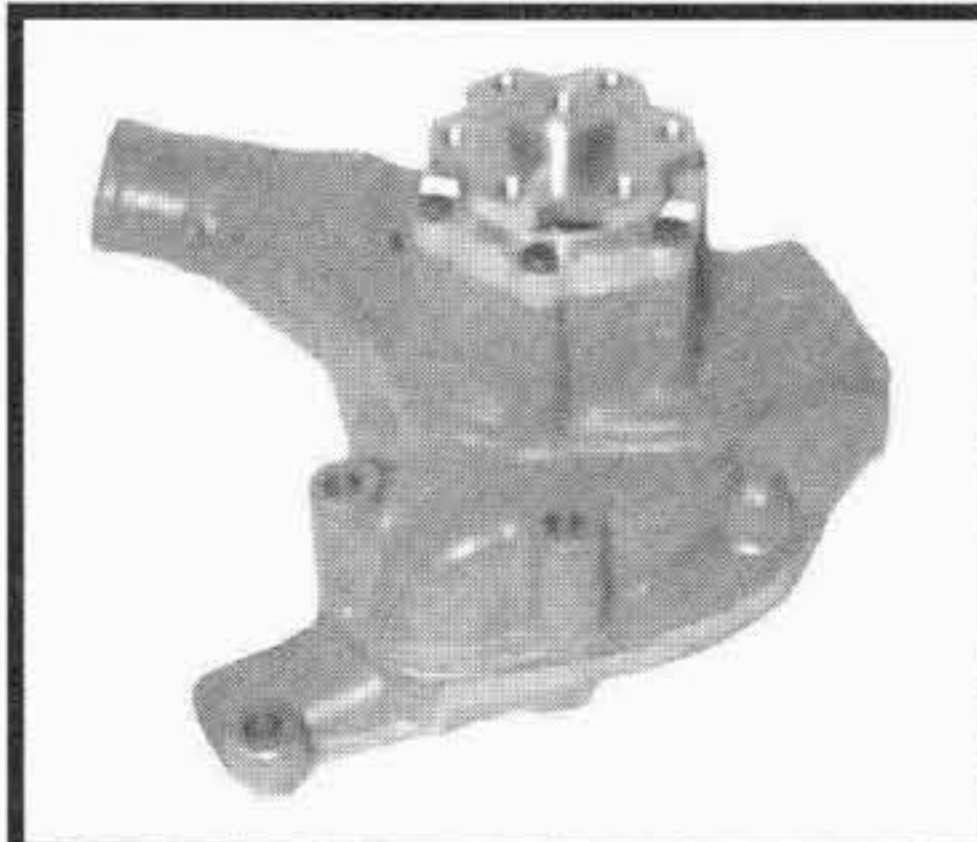

TIPO O MODELLO TYPE OU MODELE TYPE OR MODEL	MOTORE MOTEUR ENGINE	POMPA ACQUA POMPE A EAU WATER PUMP OMP REF. / O.EM. REF	KIT RIPARAZIONE NECESSAIRE DE REP. REPAIR KIT OMP REF. / O.EM. REF
408 508 - LF 508 608 709 808 809	OM 314 --> mot. 430644	--- 314.200.24.01 <div style="border: 1px solid black; padding: 5px; text-align: center;">SOST. DA : / REPLACE BY : 241.900 314.200.42.01</div> albero con foro filettato / shaft with threaded bore girante / impeller Ø 87 mm	242.223 314.200.09.04 <div style="border: 1px solid black; width: 100%; height: 100%;"></div>
408 508 - LF 508 608 709 808 809	OM 314 mot. 430345 --> --> mot. 456936	241.900 314.200.42.01 <div style="border: 1px solid black; padding: 5px; text-align: center;"></div> albero con foro filettato / shaft with threaded bore girante / impeller Ø 95 mm	242.224 314.200.10.04 <div style="border: 1px solid black; width: 100%; height: 100%;"></div>
408 508 - LF 508 608 709 808 809	OM 314 mot. 459637 -->	241.930 314.200.47.01 <div style="border: 1px solid black; padding: 5px; text-align: center;"></div>	242.225 314.200.11.04 <div style="border: 1px solid black; width: 100%; height: 100%;"></div>
L / LA / LP / LAP 311 L / LA / LP / LAP 312 L / LA / LP / LAP 328 710 L / LA / LP / LAP 911 - L / LA 911B L / LA 322 L / LA / LP / LAP 327 L / LA 1113 - LA 1313 - 1317 LA 1513 - 1517 - 1813 LF / LAF 323 328 - LF / LAF 710 L / LA 911	OM 352 --> mot. 018151 OM 352 --> mot. 034435 OM 352 --> mot. 011957	241.790 353.200.40.01 <div style="border: 1px solid black; padding: 5px; text-align: center;"></div> albero senza foro filettato / shaft without threaded bore girante / impeller Ø 87 mm	242.191 352.200.38.04 <div style="border: 1px solid black; width: 100%; height: 100%;"></div>

I ricambi non sono originali ma adattabili . Ogni riferimento originale é assolutamente indicativo .
Spare parts are not original but perfectly suitable . Every original part number has to be considered for reference purpose only .

SUITABLE

MERCEDES BENZ

AUTOCARRI - CAMIONS - TRUCKS

Tel:+44(0)1925 850082 Fax: +(0)44 1925 850083

www.spwaterpumps.co.uk

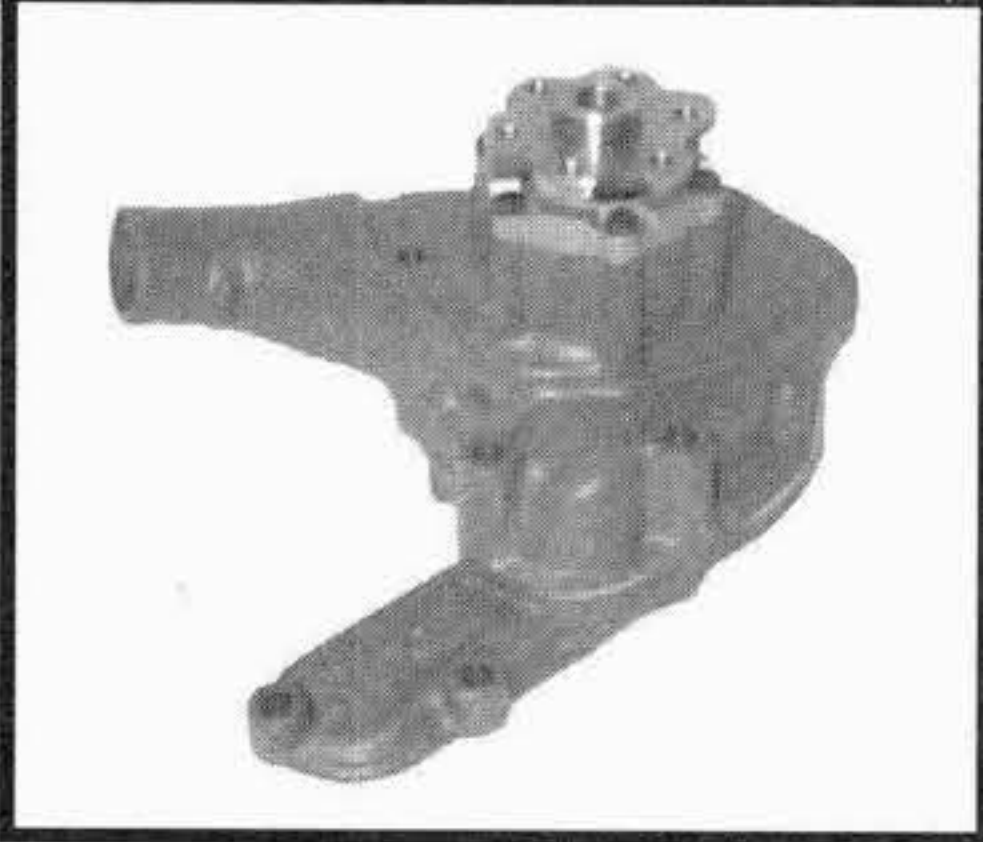

TIPO O MODELLO TYPE OU MODELE TYPE OR MODEL	MOTORE MOTEUR ENGINE	POMPA ACQUA POMPE A EAU WATER PUMP	KIT RIPARAZIONE NECESSAIRE DE REP. REPAIR KIT
LF / LAF 323 328 LF / LAF 710 L / LA 911	OM 352 mot. 011958 -->	--- 352.200.94.01 <div style="border: 1px solid black; padding: 5px; text-align: center;"> SOST. DA : / </div> <div style="border: 1px solid black; padding: 5px; text-align: center;"> REPLACE BY : 241.935 353.200.37.01 </div> albero senza foro filettato / shaft without threaded bore girante / impeller Ø 87 mm	242.191 352.200.38.04 <div style="border: 1px solid black; width: 100%; height: 100%;"></div>
L / LA / LP / LAP 311 L / LA / LP / LAP 312 L / LA / LP / LAP 328 710 L / LA / LP / LAP 911 - L / LA 911B L / LA 322 L / LA / LP / LAP 327 L / LA 1113 - LA 1313 - 1317 LA 1513 - 1517 - 1813 LF / LAF 323 328 - LF / LAF 710 L / LA 911	OM 352 OM 352 OM 352	--- 353.200.03.01 <div style="border: 1px solid black; padding: 5px; text-align: center;"> SOST. DA : / </div> <div style="border: 1px solid black; padding: 5px; text-align: center;"> REPLACE BY : 241.935 353.200.37.01 </div> albero senza foro filettato / shaft without threaded bore girante / impeller Ø 95 mm	242.228 352.200.43.04 <div style="border: 1px solid black; width: 100%; height: 100%;"></div>
L / LA / LP / LAP 311 L / LA / LP / LAP 312 L / LA / LP / LAP 328 710 L / LA / LP / LAP 911 - L / LA 911B L / LA 322 L / LA / LP / LAP 327 L / LA 1113 - LA 1313 - 1317 LA 1513 - 1517 - 1813	OM 352 mot. 018152 --> OM 352 mot. 034436 -->	--- 353.200.36.01 <div style="border: 1px solid black; padding: 5px; text-align: center;"> SOST. DA : / </div> <div style="border: 1px solid black; padding: 5px; text-align: center;"> REPLACE BY : 241.935 353.200.37.01 </div> albero con foro filettato / shaft with threaded bore girante / impeller Ø 95 mm	242.229 352.200.44.04 <div style="border: 1px solid black; width: 100%; height: 100%;"></div>
L / LA / LP / LAP 311 L / LA / LP / LAP 312 L / LA 322 - LF / LAF 323 L / LA / LP / LAP 327 L / LA / LP / LAP 328 - 328 710 - LF / LAF 710 L / LA / LP / LAP 911 - L / LA 911B L / LA 1113 - LA 1313 1317 - LA 1513 1517 - 1813	OM 352	241.935 353.200.37.01 <div style="border: 1px solid black; padding: 5px; text-align: center;">  </div> albero con foro filettato / shaft with threaded bore girante / impeller Ø 95 mm	242.229 352.200.44.04 <div style="border: 1px solid black; width: 100%; height: 100%;"></div>

I ricambi non sono originali ma adattabili . Ogni riferimento originale é assolutamente indicativo .
 Spare parts are not original but perfectly suitable . Every original part number has to be considered for reference purpose only .

SUITABLE

MERCEDES BENZ**AUTOCARRI - CAMIONS - TRUCKS****Tel:+44(0)1925 850082 Fax: +(0)44 1925 850083****www.spwaterpumps.co.uk**

TIPO O MODELLO TYPE OU MODELE TYPE OR MODEL	MOTORE MOTEUR ENGINE	POMPA ACQUA POMPE A EAU WATER PUMP	KIT RIPARAZIONE NECESSAIRE DE REP. REPAIR KIT
LP 811 LP 911 - LP 913 613 - 813 - 913 - 1013 LP / LPK 1113 1213 - LP 1213 - 1413 OF 1413 - 1613 1013 - LP / LPK 1113 1213 - LP 1213 LP 1313 1413 - OF 1413 1017 - 1217 1417 - 1617	OM 352 --> mot. 017729 OM 352 --> mot. 441885 OM 352 --> mot. 049763 OM 352 --> mot. 473680	--- 352.200.95.01 <div style="border: 1px solid black; padding: 10px; text-align: center;"> <p>SOST. DA : / REPLACE BY :</p> <p>241.940</p> <p>353.200.56.01</p> </div> albero senza foro filettato / shaft without threaded bore girante / impeller Ø 87 mm	242.205 352.200.39.04 <div style="border: 1px solid black; width: 100%; height: 100%;"></div>
810 - 811 - LP 811 LP 911 - LP 913 613 - 813 - 913 - 1013 LP / LPK 1113 - 1213 - LP 1213 1413 - OF 1413 - 1613 1013 - LP / LPK 1113 - 1213 LP 1213 - LP 1313 - 1413 - OF 1413 1413 - OF 1413 1017 - 1217 1417 - 1617 1513 LP	OM 352 mot. 017730 --> OM 352 mot. 441886 --> OM 352 mot. 049764 --> OM 352 mot. 473681 --> OM 352	--- 352.200.96.01 <div style="border: 1px solid black; padding: 10px; text-align: center;"> <p>SOST. DA : / REPLACE BY :</p> <p>241.940</p> <p>353.200.56.01</p> </div> albero senza foro filettato / shaft without threaded bore girante / impeller Ø 95 mm	242.164 352.200.41.04 <div style="border: 1px solid black; width: 100%; height: 100%;"></div>
LP 810 LP 813 911 B	OM 352.985	--- 352.200.97.01 <div style="border: 1px solid black; padding: 10px; text-align: center;"> <p>SOST. DA : / REPLACE BY :</p> <p>241.940</p> <p>353.200.56.01</p> </div> albero con foro filettato / shaft with threaded bore girante / impeller Ø 87 mm	242.164 352.200.41.04 <div style="border: 1px solid black; width: 100%; height: 100%;"></div>
810 - 811 - LP 811 LP 911 - LP 913 613 - 813 - 913 - 1013 LP / LPK 1113 - 1213 - LP 1213 1413 - OF 1413 - 1613 1013 - LP / LPK 1113 - 1213 LP 1213 - LP 1313 - 1413 - OF 1413 1413 - OF 1413 1017 - 1217 1417 - 1617 1513 LP	OM 352 OM 352 OM 352 OM 352 OM 352	--- 353.200.16.01 <div style="border: 1px solid black; padding: 10px; text-align: center;"> <p>SOST. DA : / REPLACE BY :</p> <p>241.940</p> <p>353.200.56.01</p> </div> albero senza foro filettato / shaft without threaded bore girante / impeller Ø 95 mm	242.164 352.200.40.04 <div style="border: 1px solid black; width: 100%; height: 100%;"></div>

I ricambi non sono originali ma adattabili . Ogni riferimento originale é assolutamente indicativo .
 Spare parts are not original but perfectly suitable . Every original part number has to be considered for reference purpose only .



SUITABLE

MERCEDES BENZ AUTOCARRI - CAMIONS - TRUCKS

Tel:+44(0)1925 850082 Fax: +(0)44 1925 850083

www.spwaterpumps.co.uk

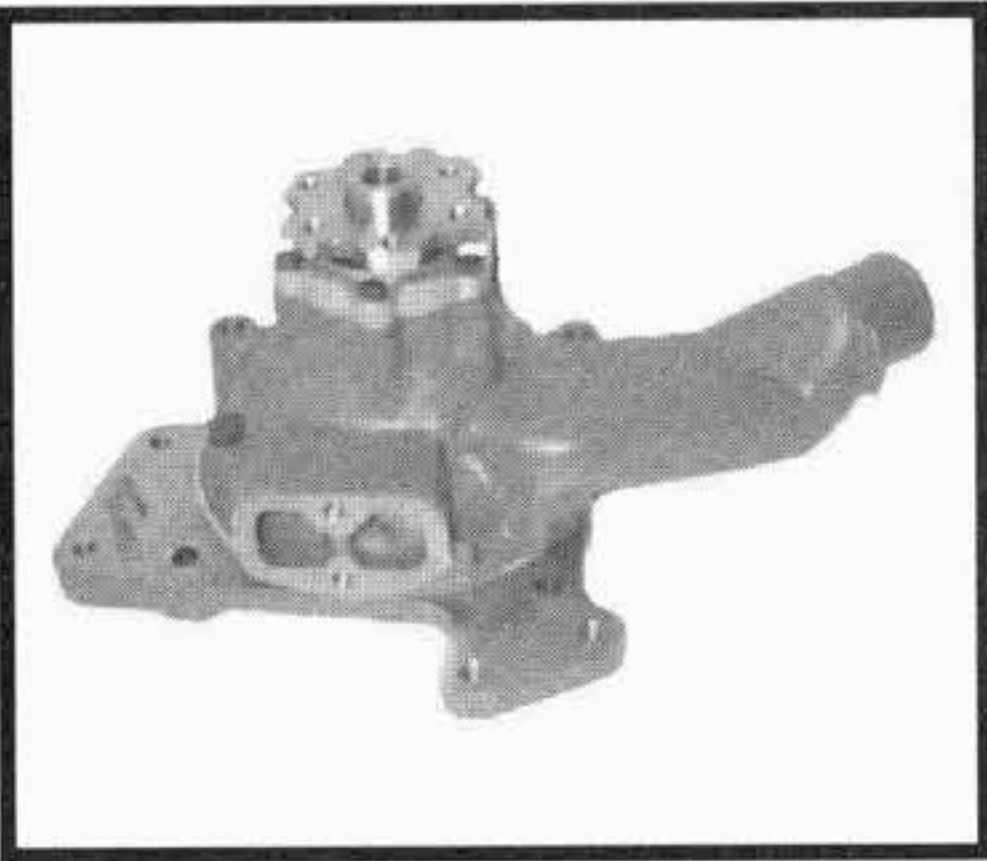
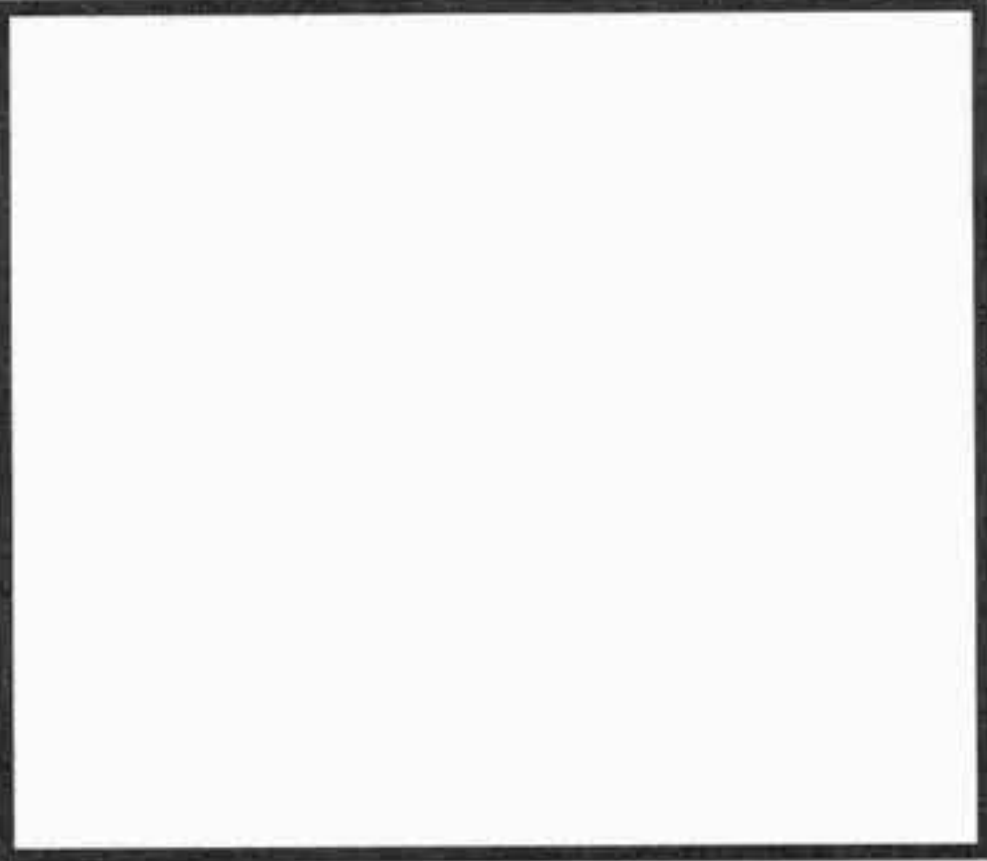

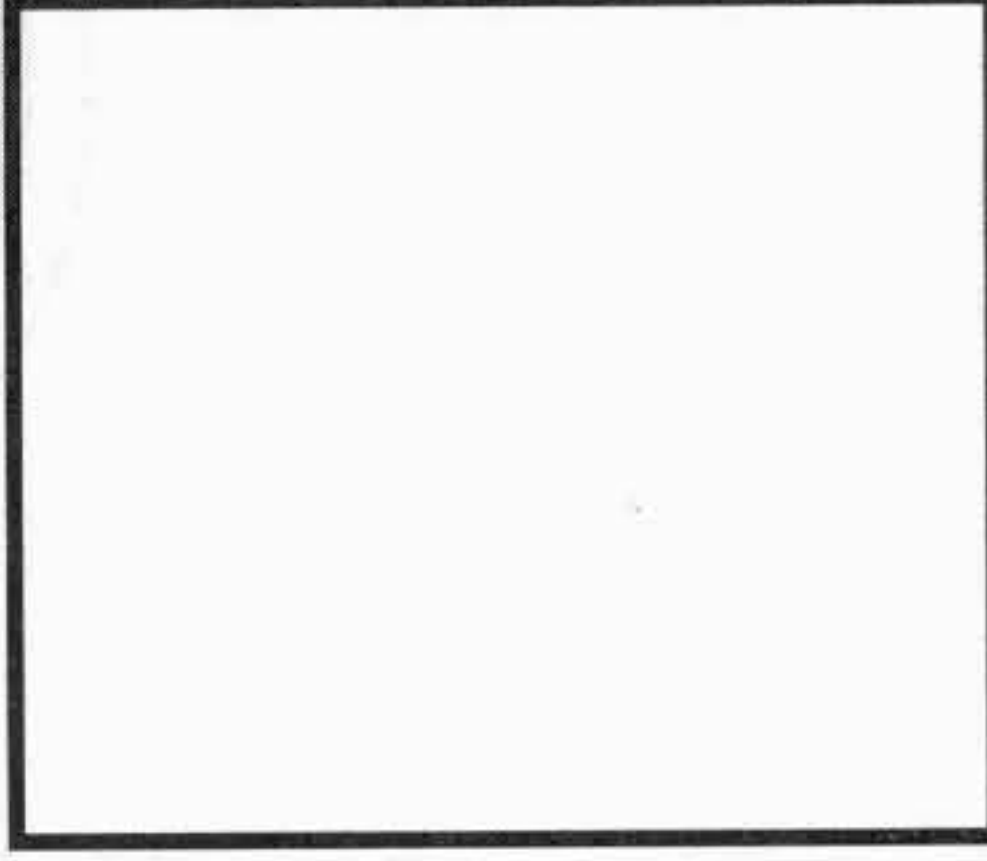
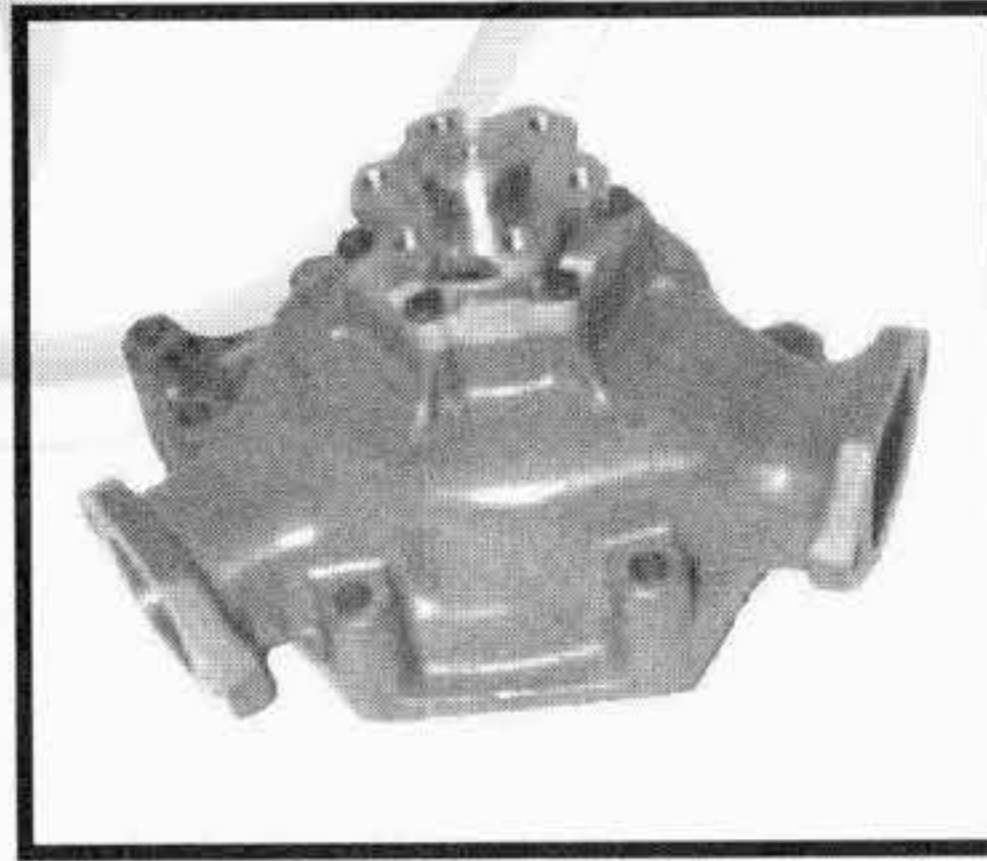
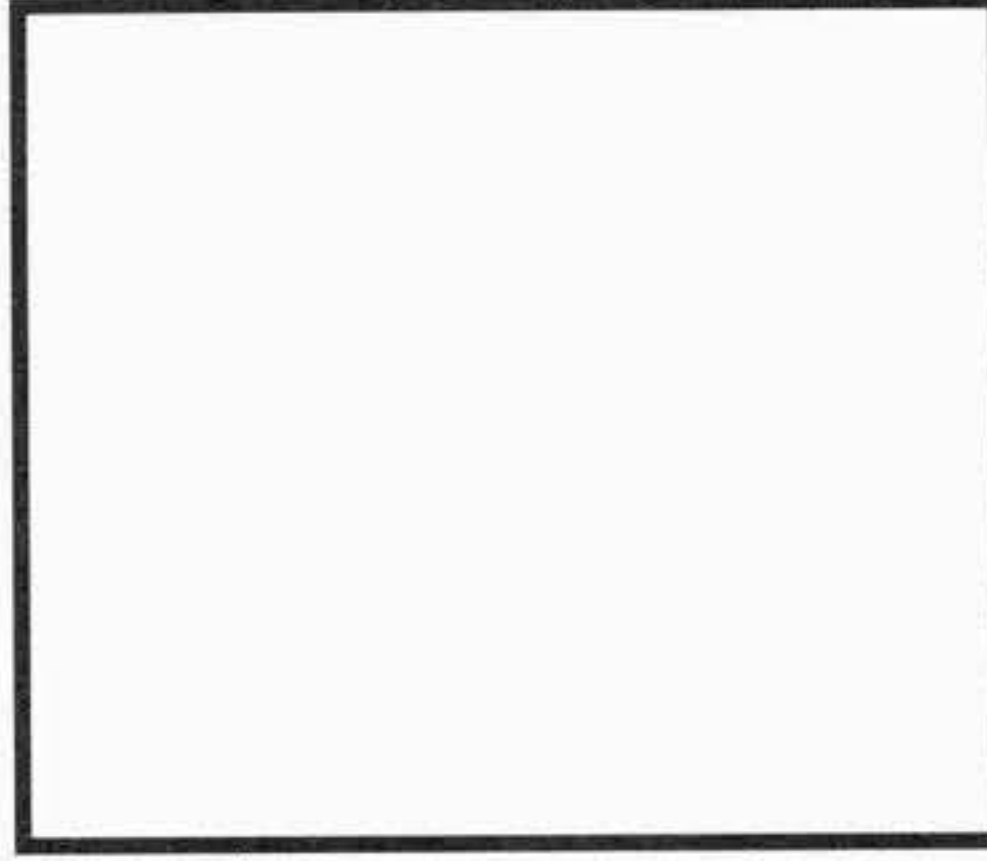
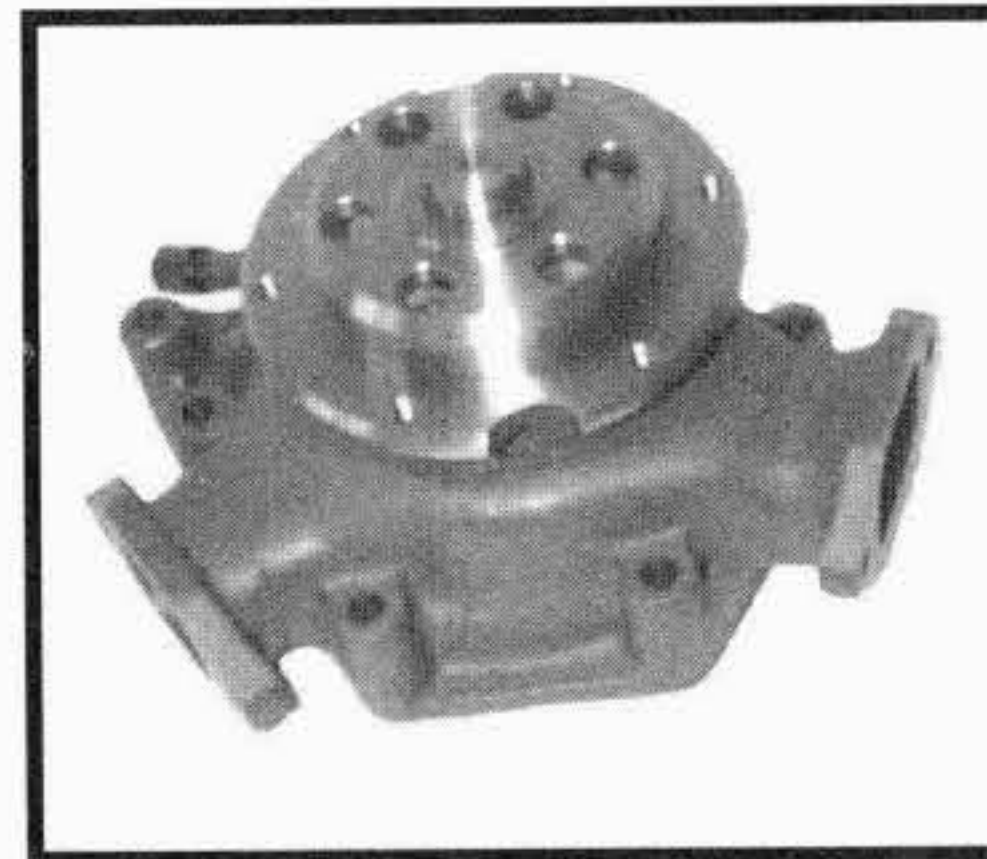
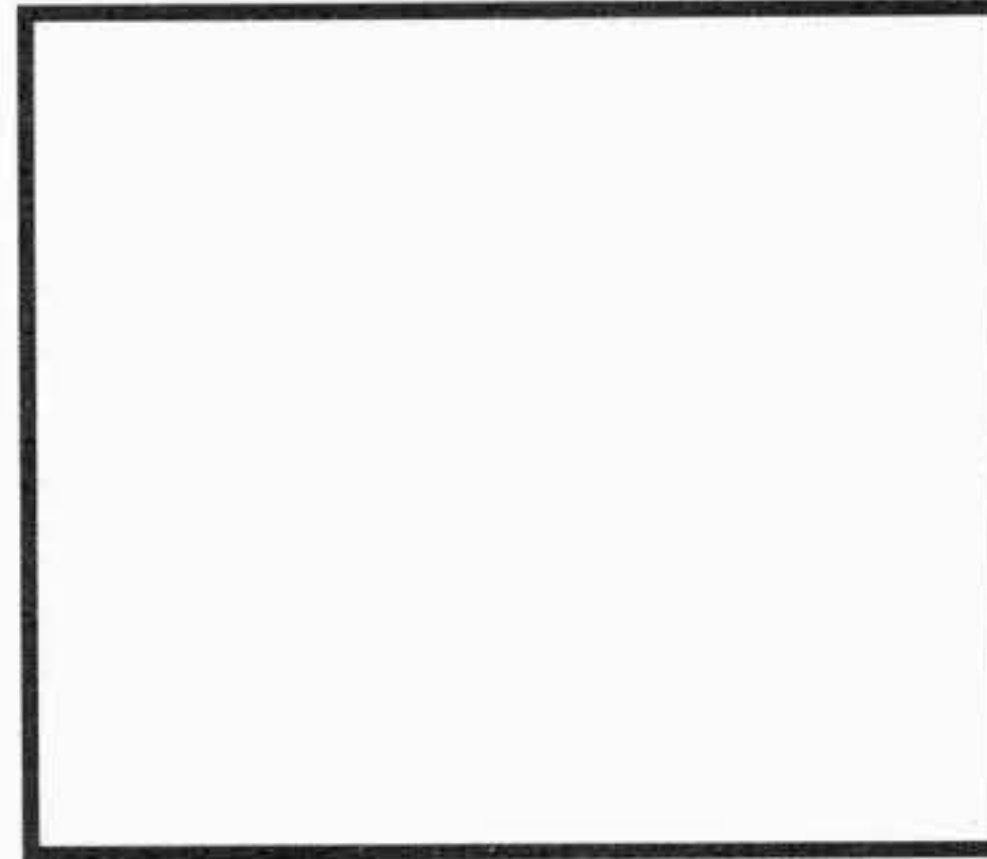
TIPO O MODELLO TYPE OU MODELE TYPE OR MODEL	MOTORE MOTEUR ENGINE	POMPA ACQUA POMPE A EAU WATER PUMP OMP REF. / O.EM. REF	KIT RIPARAZIONE NECESSAIRE DE REP. REPAIR KIT OMP REF. / O.EM. REF
LP 810 LP 813 911 B 1217 S 1419 C / CL / L / LS 1420 - 1420 L 1617 1619 C 1620 2219 - 2219 CL 2220 2222	OM 352.985 OM 362 OM 362 LA	241.940 353.200.56.01  albero con foro filettato / shaft with threaded bore girante / impeller Ø 95 mm	242.230 352.200.45.04 
L / LA 329 - L / LA / LP 331 L / LA 332 - LP 333 - L / LP 334 LP / LPS 1418 - LAK 1518 - 1618 1620 - 1623 - 1920 - 2023 2024 - 2220 - 2620 1620 - 1624 - 2223 2224 - 2624 1920 1924 - 2023 - 2024 2220 - 2224 - 2624	OM 346.910 OM 346.912 - 917 OM 346.919 OM 355.912 OM 355.914 OM 355.913 OM 355.910	241.760 355.200.00.01  	242.075 355.200.05.04 
OH 1419 OH 1517 OH 1519 1924 1929 2219	OM 355 BRAZIL 5 cyl. - 6 cyl.	241.955 345.200.71.01  girante / impeller Ø 120 mm	242.161 355.200.14.04 
1424 1621 L / LA / LAP 1624 1921 L / LA / LAP 1924 1928 LPS 2024 LP 2223 2224 - LP 2224 L / LA / LK 2624 2628	OM 355 - 6 cyl.	241.800 355.200.08.01  girante / impeller Ø 115 mm	242.076 355.200.13.04 

I ricambi non sono originali ma adattabili . Ogni riferimento originale é assolutamente indicativo .

Spare parts are not original but perfectly suitable . Every original part number has to be considered for reference purpose only .

SUITABLE

MERCEDES BENZ**AUTOCARRI - CAMIONS - TRUCKS****Tel:+44(0)1925 850082 Fax: +(0)44 1925 850083****www.spwaterpumps.co.uk**

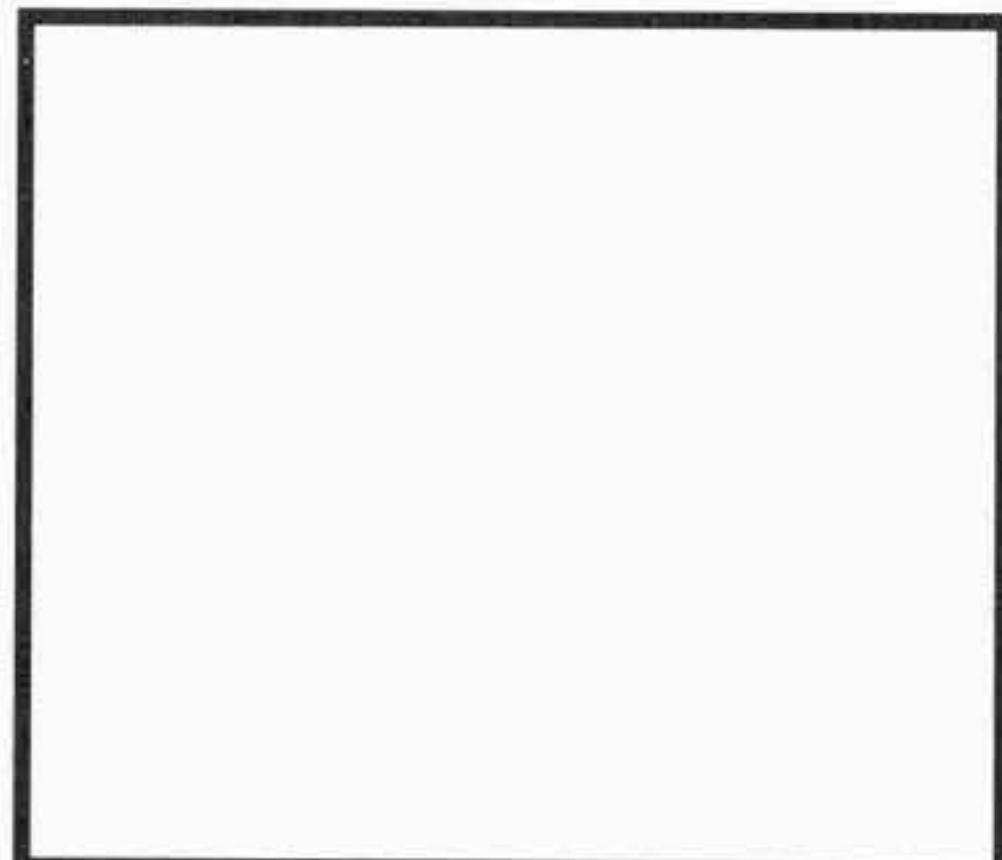
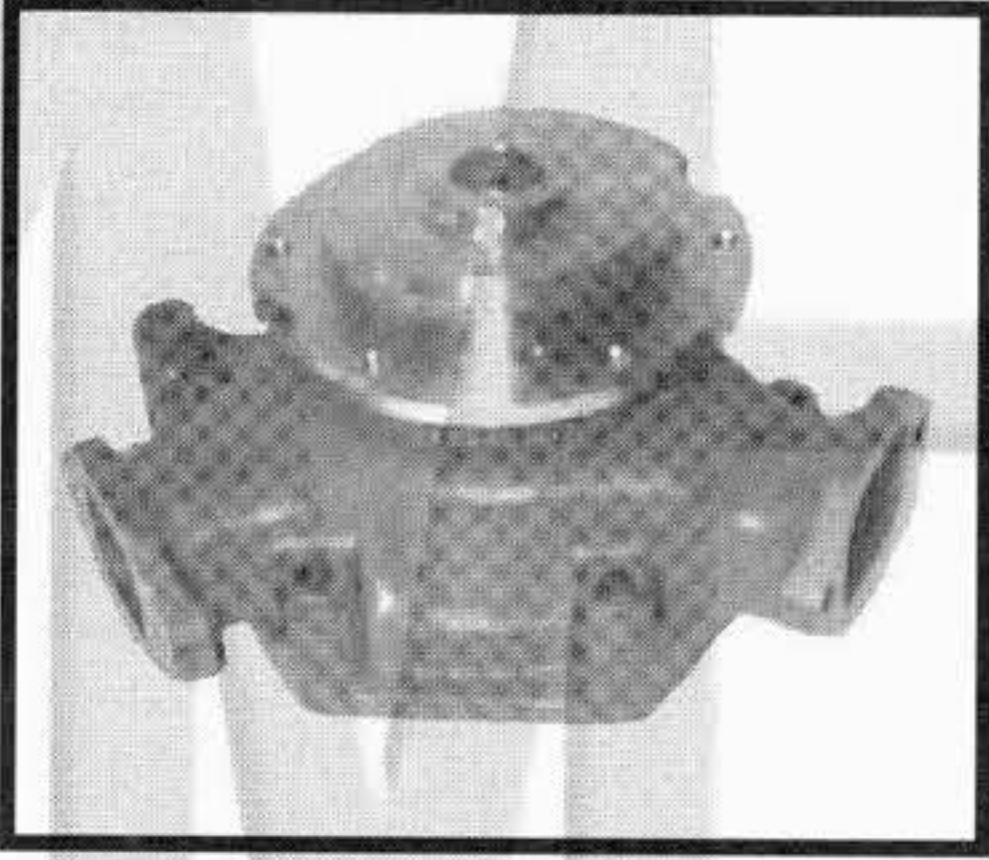
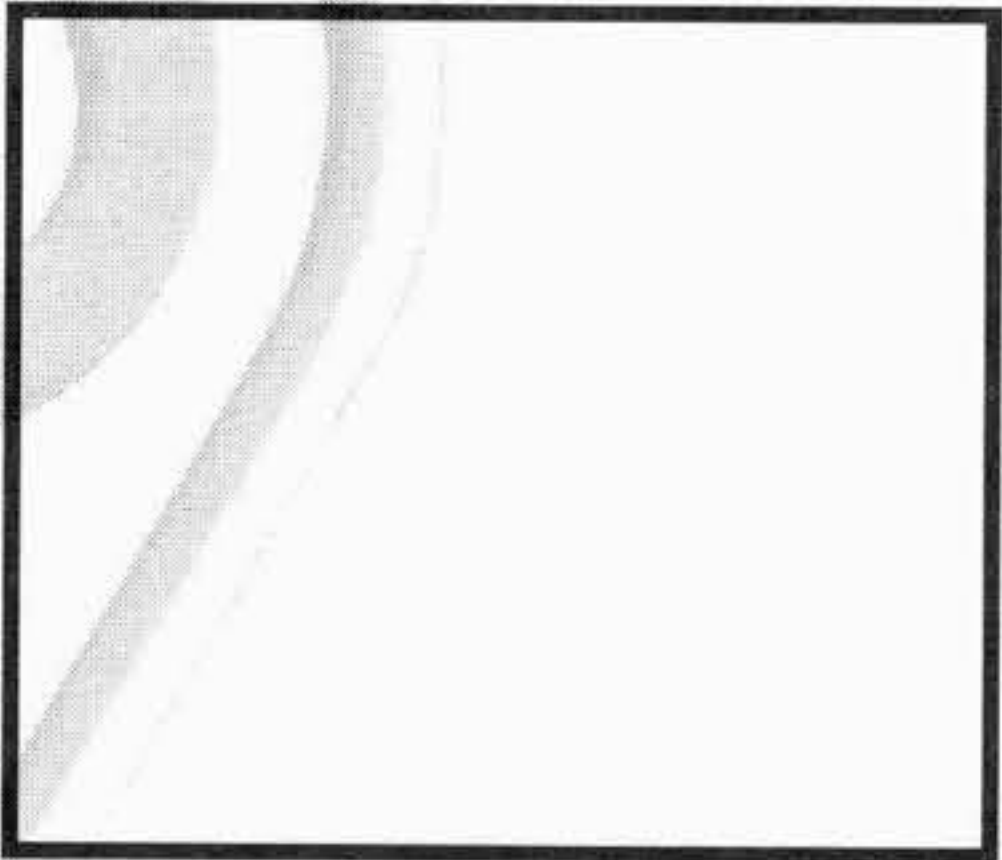
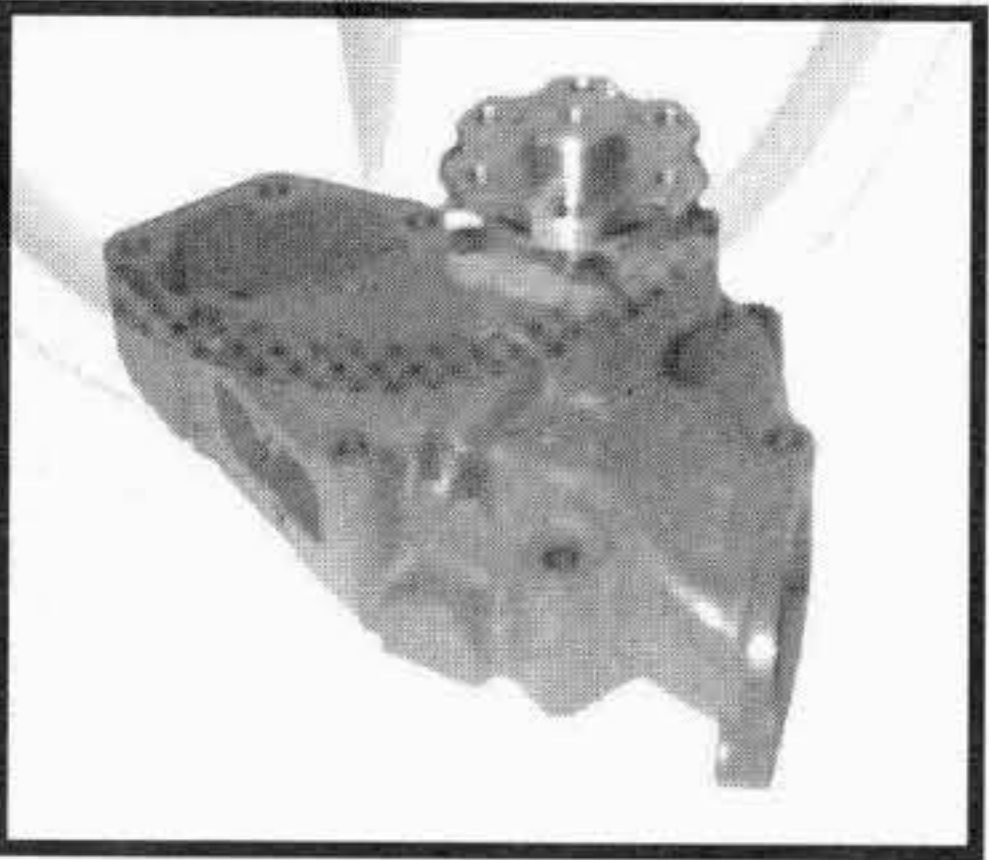
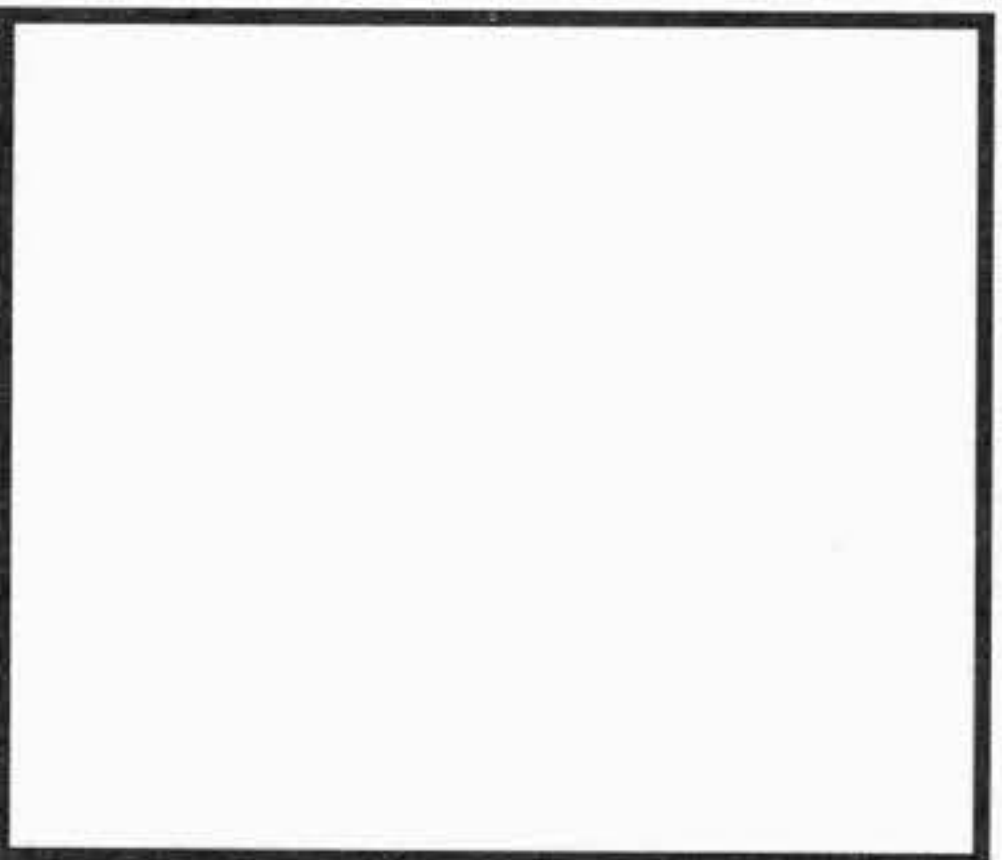
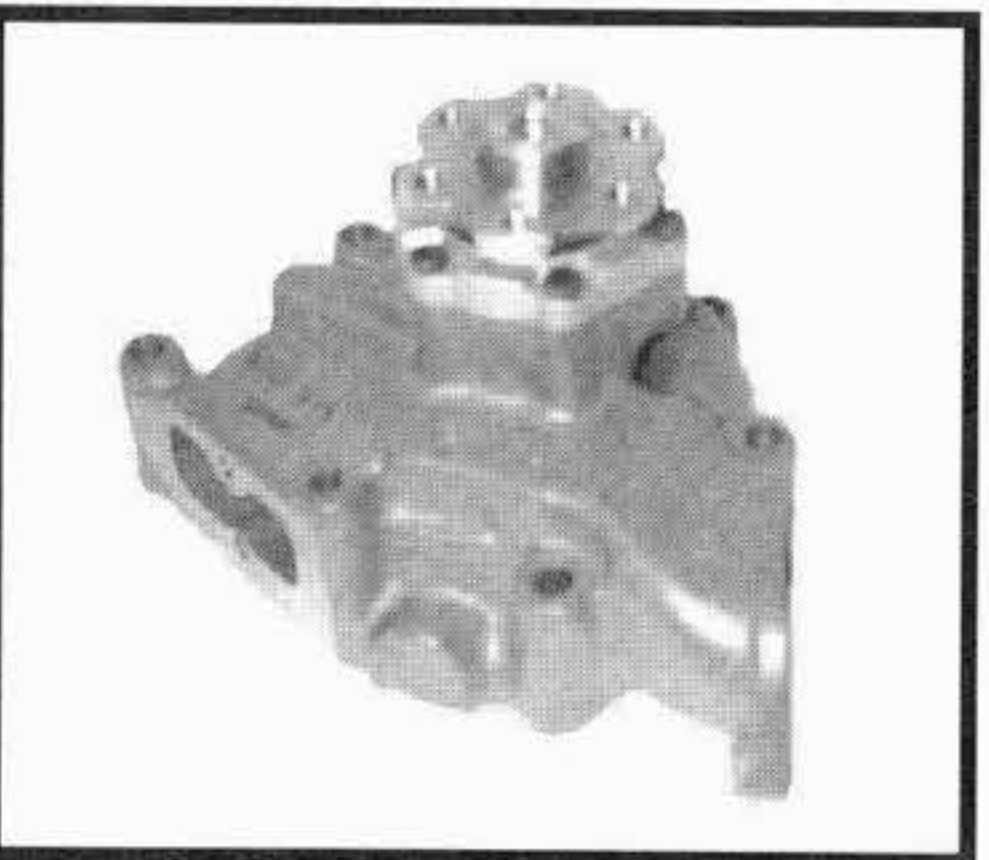
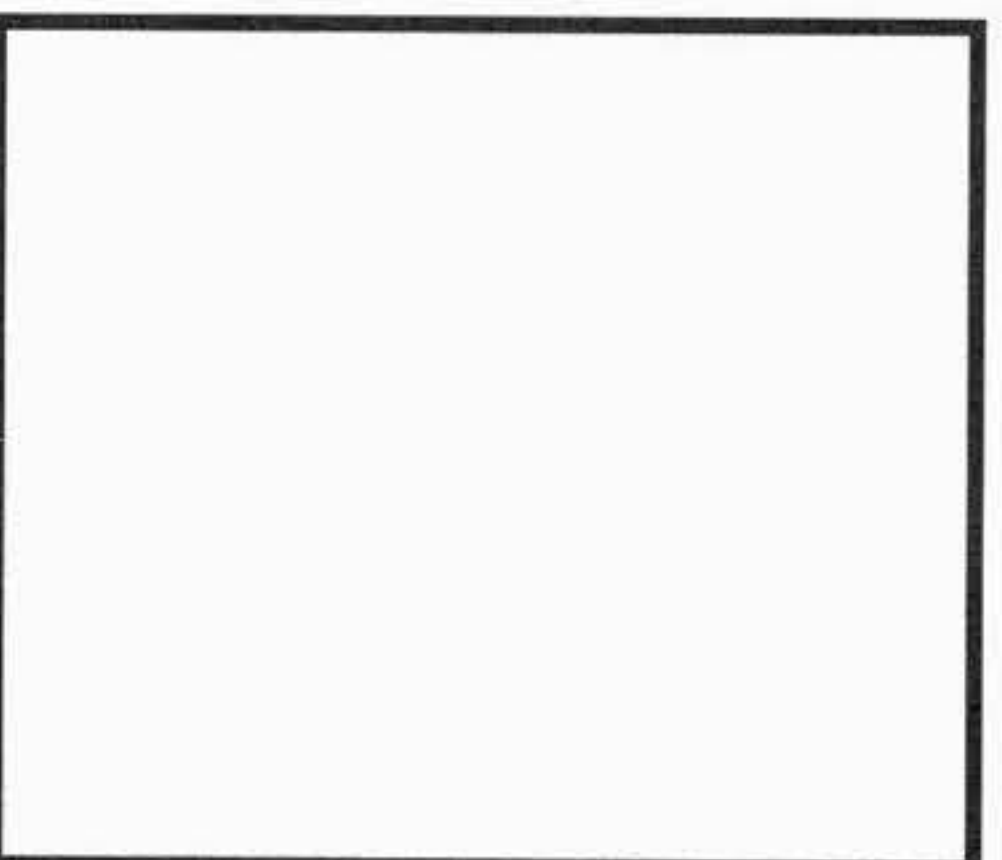
TIPO O MODELLO TYPE OU MODELE TYPE OR MODEL	MOTORE MOTEUR ENGINE	POMPA ACQUA POMPE A EAU WATER PUMP OMP REF. / O.EM. REF	KIT RIPARAZIONE NECESSAIRE DE REP. REPAIR KIT OMP REF. / O.EM. REF
1424 1621 L / LA / LAP 1624 1921 L / LA / LAP 1924 1928 LPS 2024 LP 2223 2224 - LP 2224 L / LA / LK 2624 2628	OM 355 - 6 cyl.	241.890 355.200.09.01  girante / impeller Ø 120 mm	242.161 355.200.14.04 
1424 1621 L / LA / LAP 1624 1921 L / LA / LAP 1924 1928 LPS 2024 LP 2223 2224 - LP 2224 L / LA / LK 2624 2628	OM 355 - 6 cyl.	241.905 355.200.15.01  con albero cuscinetto / with shaft bearing girante / impeller Ø 120 mm	242.212 355.200.12.04 
LP 1317 - OF 1317 OF 1417 LP 1517 LP 1519 LP 1617 1619 OF 1621 2219 <i>autocarri con guida a sinistra camions avec conduite a gauche trucks with left-hand drive</i>	OM 360	241.735 360.200.45.01  albero senza foro filettato / shaft without threaded bore	242.071 360.200.06.04 
LP 1317 - OF 1317 1319 OF 1417 LA 1517 - LP 1517 LA 1519 - LP 1519 LP 1617 1619 OF 1621 1817 - 1819 - 2219	OM 360	241.740 360.200.46.01  albero con foro filettato / shaft with threaded bore	242.058 360.200.07.04 

I ricambi non sono originali ma adattabili . Ogni riferimento originale é assolutamente indicativo .
 Spare parts are not original but perfectly suitable . Every original part number has to be considered for reference purpose only .

SUITABLE





MERCEDES BENZ

AUTOCARRI - CAMIONS - TRUCK

Tel:+44(0)1925 850082 Fax: +(0)44 1925 850083

www.spwaterpumps.co.uk

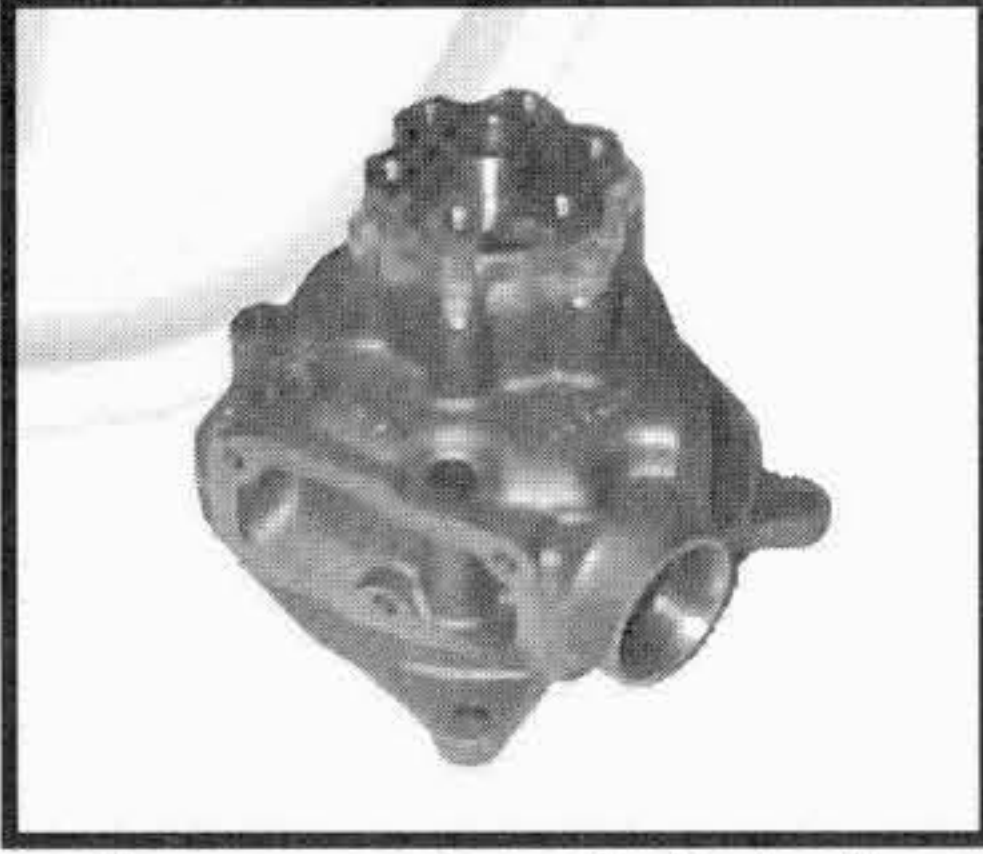
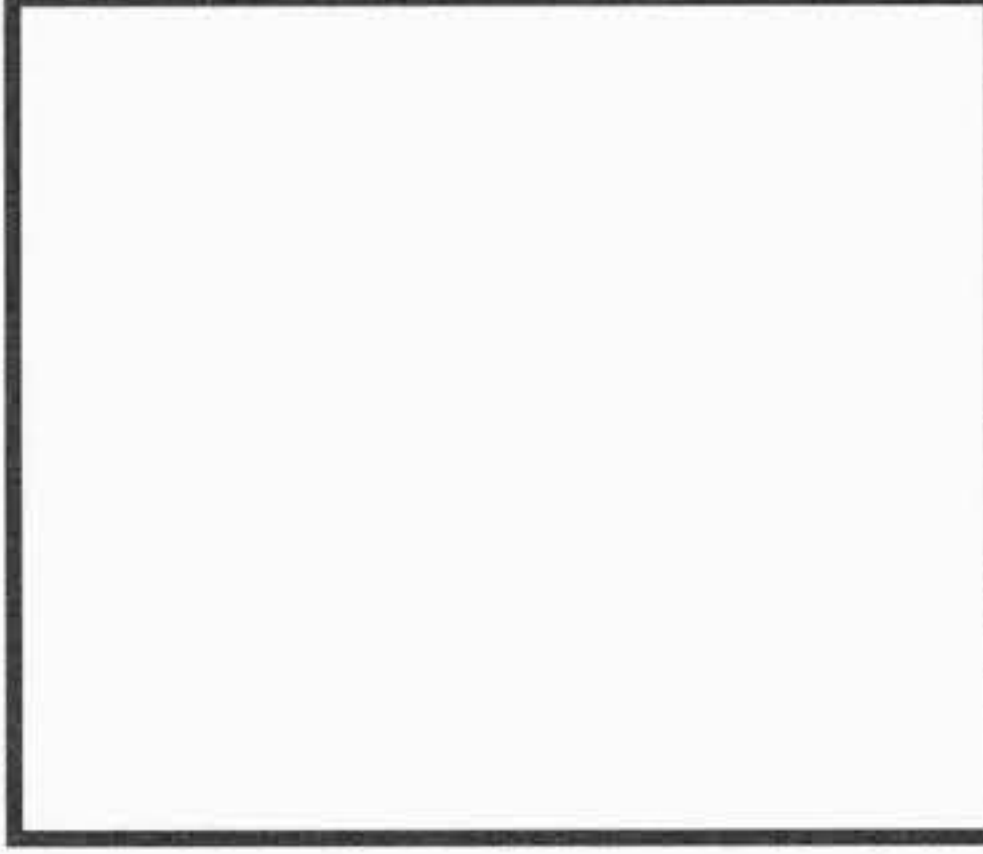
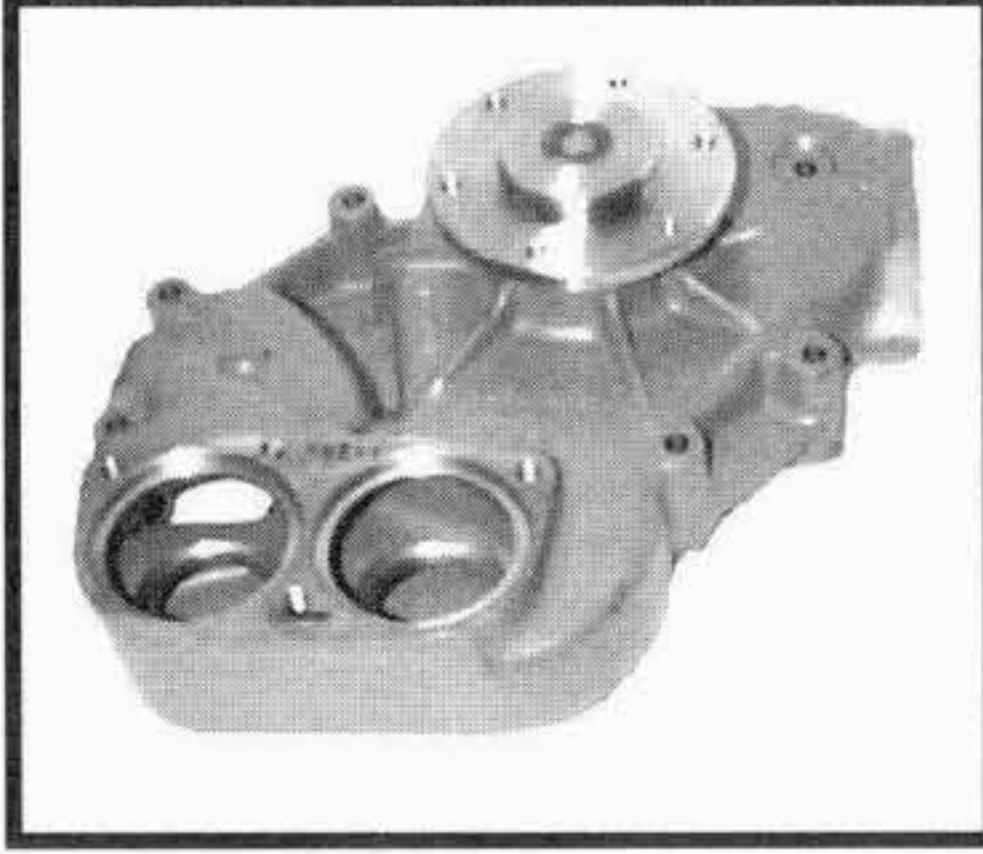
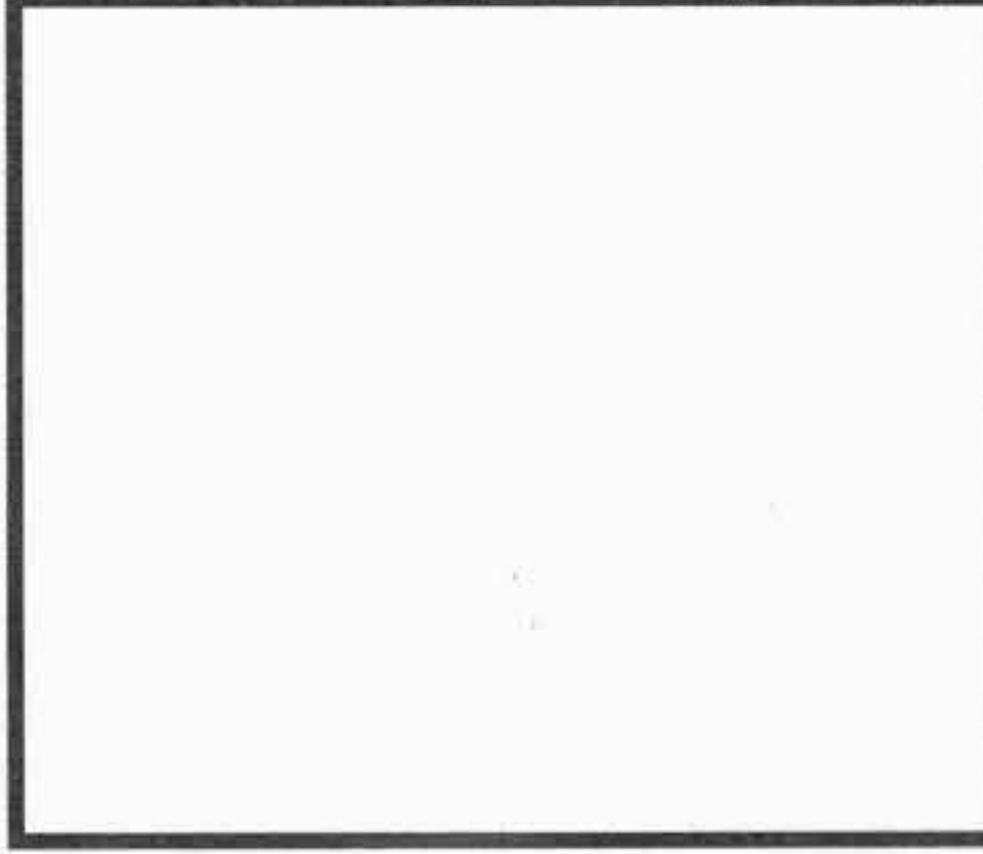

TIPO O MODELLO TYPE OU MODELE TYPE OR MODEL	MOTORE MOTEUR ENGINE	POMPA ACQUA POMPE A EAU WATER PUMP OMP REF. / O.EM. REF	KIT RIPARAZIONE NECESSAIRE DE REP. REPAIR KIT OMP REF. / O.EM. REF
609 - 609 DS 709 D 809 711 811 814 D	OM 364 OM 364 A	241.965 364.200.20.01  albero con foro filettato / shaft with threaded bore girante / impeller Ø 95 mm	242.248 364.200.08.04 
814 - 914 - 1114 1314 - 1414 - 1614 817 - 917 - 1117 - 1317 1417 - OH 1417 - 1517 - 1617 1017 - 1120 - 1320 - 1320 S 1324 - 1419 C / CL / L / LS 1520 - 1524 - 1617 - 1619 1620 - 1720 NAW - 2219 2220 - 2222	OM 366 OM 366 A OM 366 LA	241.975 366.200.59.01  albero con foro filettato / shaft with threaded bore girante / impeller Ø 95 mm	242.249 366.200.08.04 
817 - 917 - 1117 - 1317 1417 - 1517 1120 - 1320 - 1320 1520 - 1720 - 1820	OM 366 LA EURO II 357.900 ÷ 919 125 kW ÷ 170 CV OM 366 LA EURO II 357.920 ÷ 927 155 kW ÷ 211 CV	241.985 366.200.60.01  albero con foro filettato / shaft with threaded bore girante / impeller Ø 95 mm	242.249 366.200.08.04 
1019 - 1219 - 1419 F / L / LS / S 1424 / F - 1619 L - 1619 S 1719 - 1819 - 1919 2219 / L / K - 2419 1624 - 1626 K / L / LP - 1924 L 1926 K / AK - 2026 - 2224 B / K 2226 - 2626 AB / AK 1626 K / L / LP - 1632 K / L / LP 1926 - 1932 - 2032 6x2 - 2226 2232 - 2626 AB / AK 2632 AK / AS - 3032 8x4 2421	OM 401 --> mot. 129660 OM 402 --> mot. 129660 OM 403 --> mot. 129660 OM 421	241.825 403.200.70.01  note : girante / impeller Ø 125 mm	242.181 422.200.03.04 

I ricambi non sono originali ma adattabili . Ogni riferimento originale é assolutamente indicativo .

Spare parts are not original but perfectly suitable . Every original part number has to be considered for reference purpose only .

SUITABLE

MERCEDES BENZ

AUTOCARRI - CAMIONS - TRUCKS

Tel:+44(0)1925 850082 Fax: +(0)44 1925 850083

www.spwaterpumps.co.uk

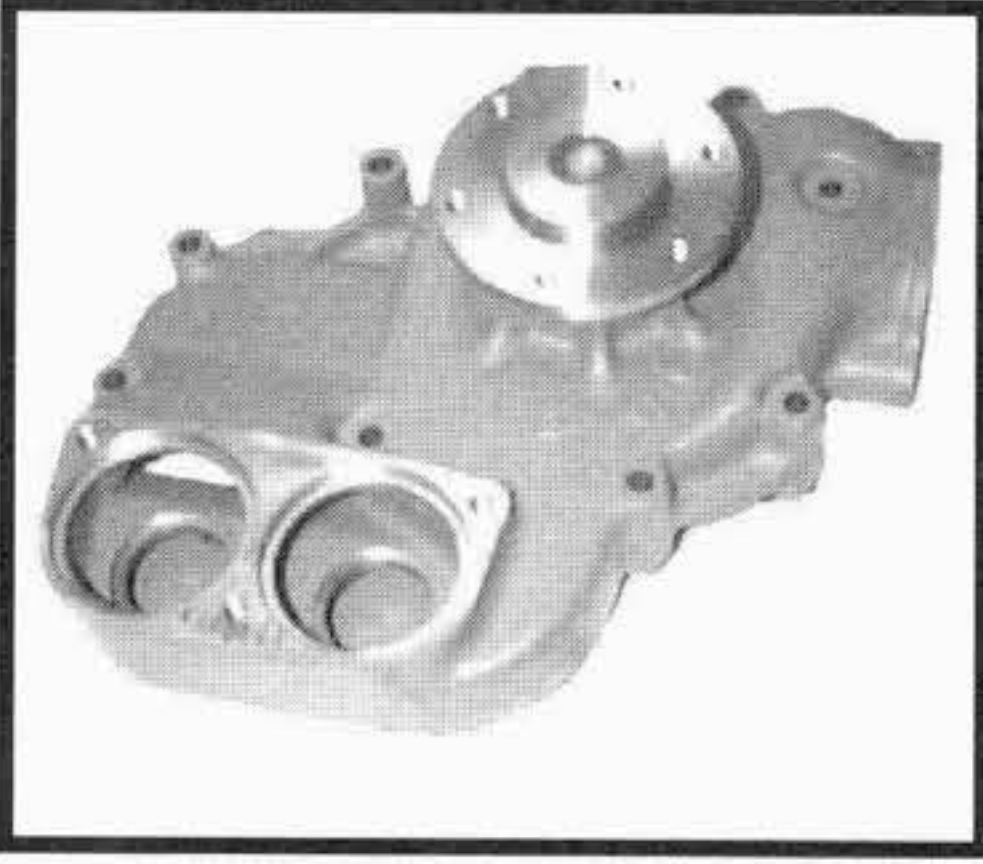
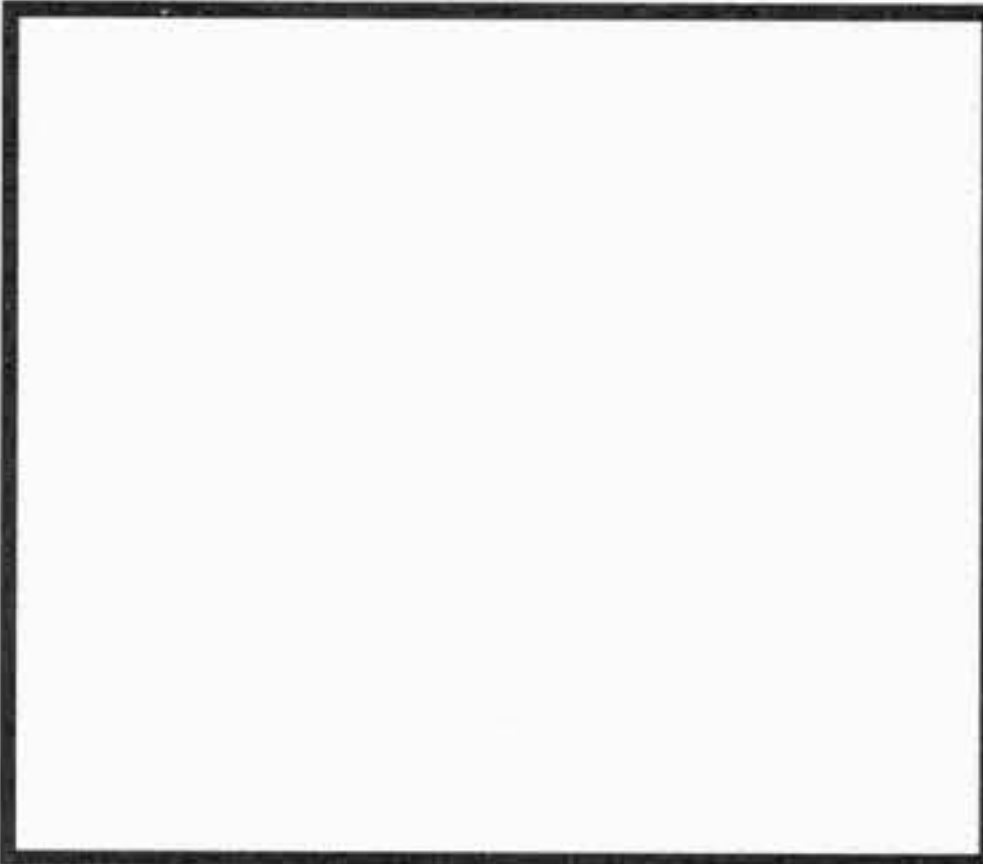
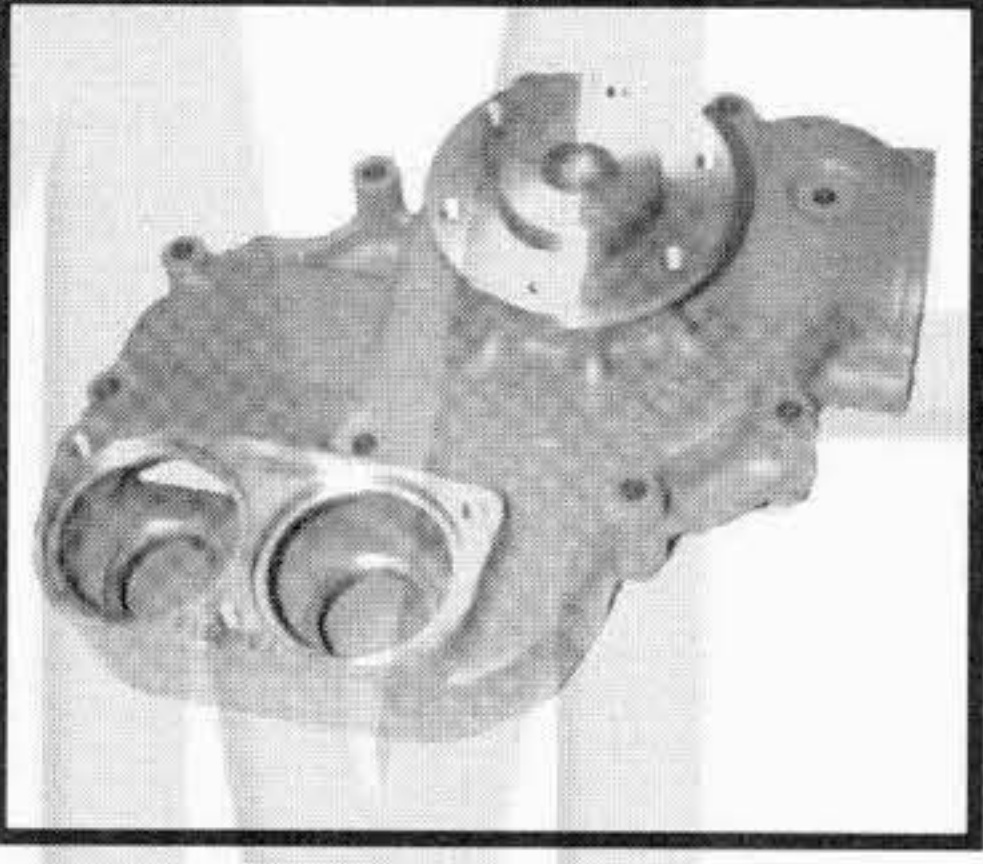
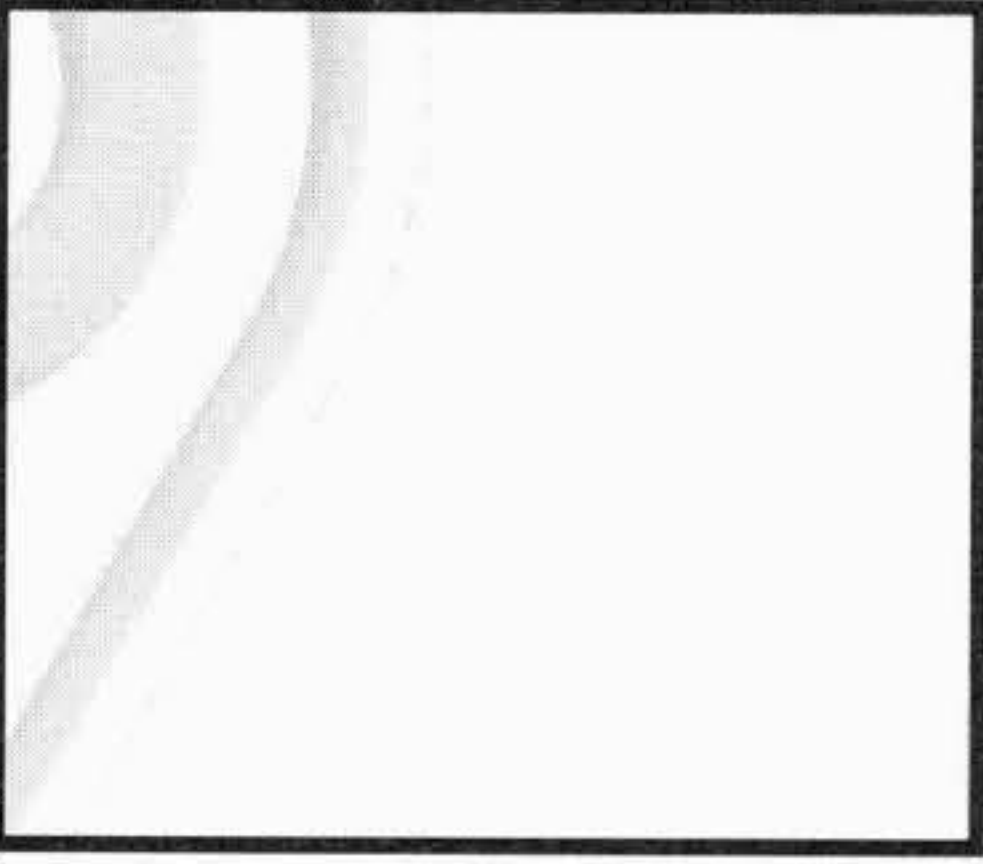
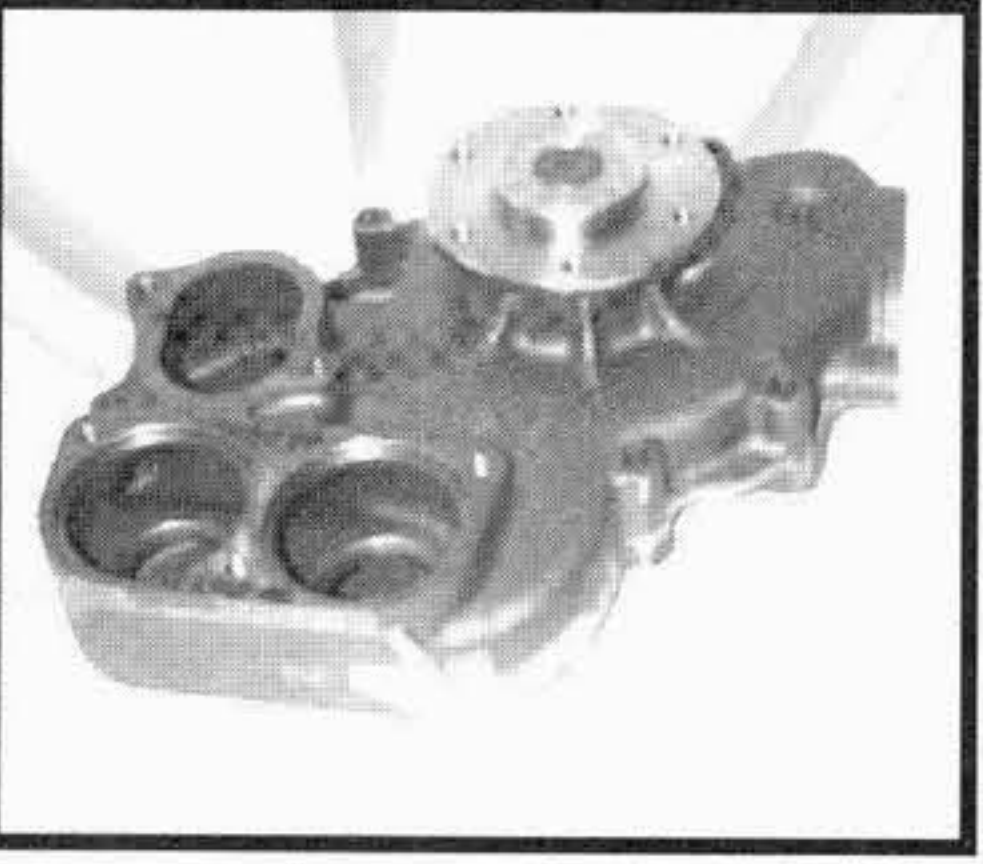
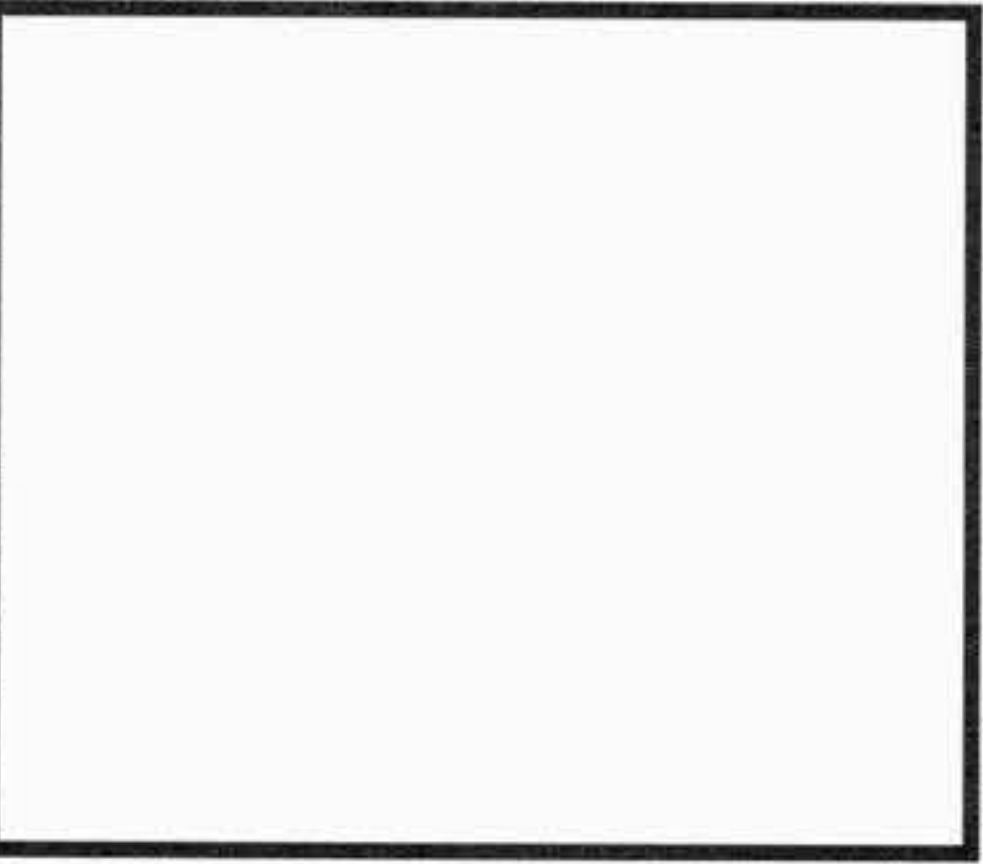
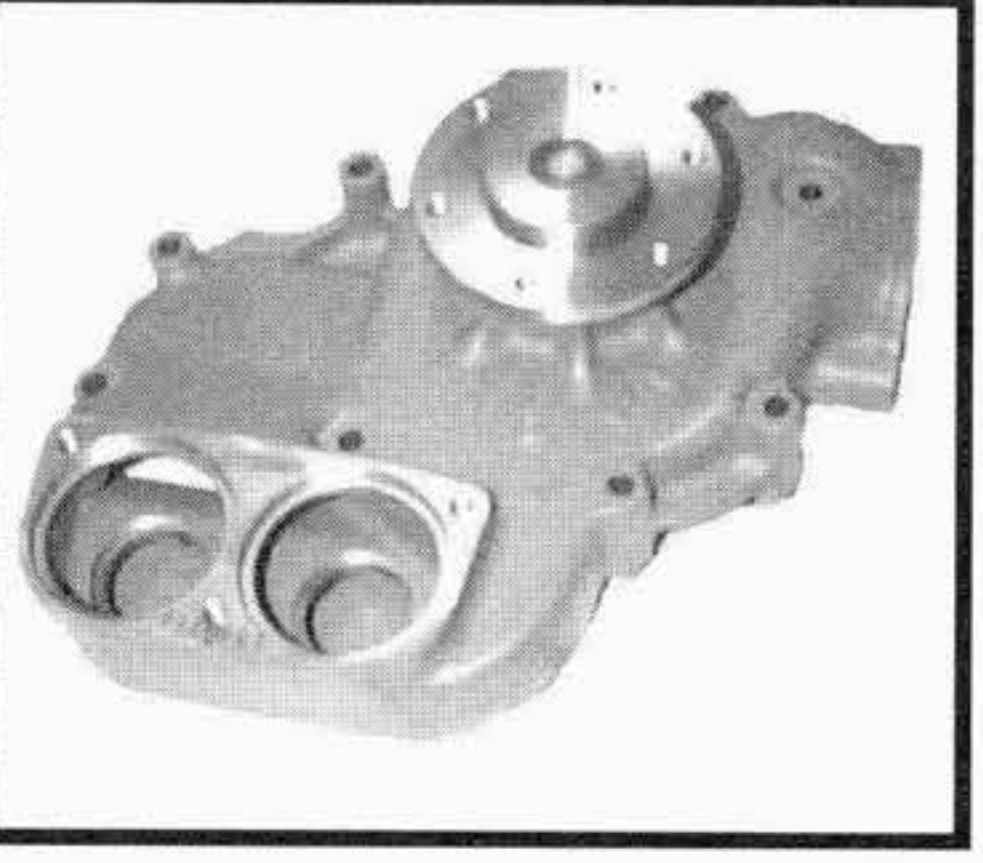
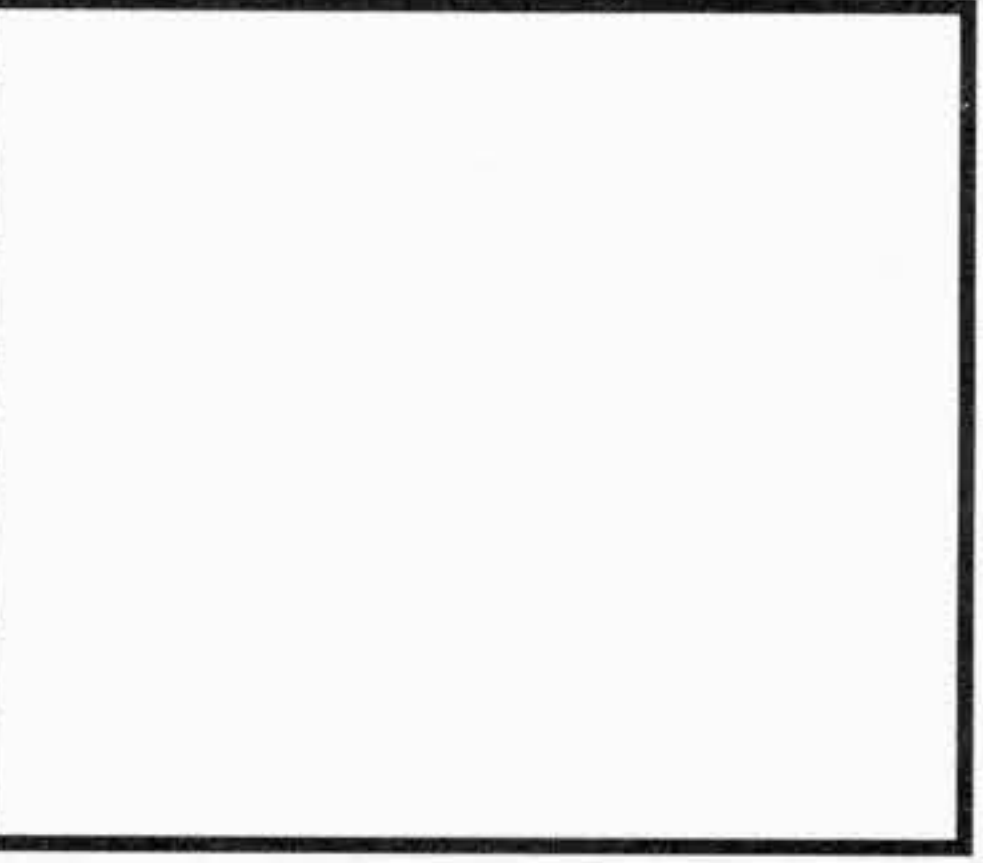

TIPO O MODELLO TYPE OU MODELE TYPE OR MODEL	MOTORE MOTEUR ENGINE	POMPA ACQUA POMPE A EAU WATER PUMP OMP REF. / O.EM. REF	KIT RIPARAZIONE NECESSAIRE DE REP. REPAIR KIT OMP REF. / O.EM. REF
1019 - 1219 - 1419 F/L/LS/S - 1424 / F 1619 L - 1619 S - 1719 - 1819 - 1919 2219 / L / K - 2419 1624 - 1626 K / L / LP - 1924 L - 1926 K / AK 2026 - 2224 B / K - 2226 - 2626 AB / AK 1626 K / L / LP - 1632 K / L / LP - 1926 - 1932 2032 6 x 2 - 2226 - 2232 - 2626 AB / AK 2632 AK / AS - 3032 8 x 4 1222 - 1422 - 1621 S - 1622 OH 1622 - 1922 - 2221 1425 - 1625 - 1628 - 1928 - 2025 - 2028 - 2225 2228 - 2628 - 3025 - 3028 - 3228 - 3328 1633 - 1933 - 2033 - 2233 - 2633 - 3333 8 X 4 1638 - 1938 - 2238 - 2638 1636 - 1936 - 2036 - 2236 - 2636 - 3333 8 X 4 1222 - 1422 - 1622 - 1722 - 1922 2222 - 2225 - 2422 - 2426 - 2429 1628 - 1733 - 2228 - 2433 1426 - 1625 - 1726 - 1729 - 1928 - 1929 2225 - 2422 - 2426 - 2429 - 2629 - 3529 1635 - 1635 L - 1735 - 1935 - 2035 S / LS 2235 - 2435 - 2635 - 3235 - 3535 1644 - 1748 - 1944 - 1944 S 1948 - 2244 - 2448 - 2644 - 2648	OM 401 mot. 129661 --> OM 402 mot. 129661 --> OM 403 mot. 129661 --> OM 421 OM 422 OM 422 A OM 422 LA OM 423 OM 441 --> mot. 504397 OM 441 LA --> mot. 504397 OM 442 --> mot. 504397 OM 442 A --> mot. 504397 OM 442 LA --> mot. 504397	<p>241.835 403.200.71.01</p>  <p>note : girante / impeller Ø 125 mm</p>	<p>242.181 422.200.03.04</p> 
1222 - 1422 - 1622 - 1722 - 1922 - 2222 2225 - 2422 - 2426 - 2429 1628 - 1733 - 2228 - 2433 1426 - 1625 - 1726 - 1729 - 1928 - 1929 2225 - 2422 - 2426 - 2429 - 2629 - 3529 1635 - 1635 L - 1735 - 1935 - 2035 S/LS 2235 - 2435 - 2635 - 3235 - 3535 1644 - 1748 - 1944 - 1944 S 1948 - 2244 - 2448 - 2644 - 2648 1827 - 1831 - 1834 - 2531 - 2534 ECOLINER 1838 - 2038 - 2538 - 1844 - 2044	OM 441 mot. 504398 --> OM 441 LA mot. 504398 --> OM 442 mot. 504398 --> OM 442 A mot. 504398 --> OM 442 LA mot. 504398 --> OM 441 LA OM 442 LA	<p>241.995 441.200.02.01</p> 	<p>242.265 441.200.01.04</p> 
3236	OM 423.909	<p>241.950 403.200.74.01</p>  <p>note : girante / impeller Ø 125 mm</p>	<p>242.181 422.200.03.04</p> 
3250 3850 4050 ECOLINER 1850 - 2050	OM 423 LA	<p>241.960 422.200.10.01</p>  <p>note : girante / impeller Ø 135 mm</p>	<p>242.237 422.200.04.04</p> 

I ricambi non sono originali ma adattabili . Ogni riferimento originale é assolutamente indicativo .
 Spare parts are not original but perfectly suitable . Every original part number has to be considered for reference purpose only .

SUITABLE





MERCEDES BENZ

AUTOCARRI - CAMIONS - TRUCKS

Tel:+44(0)1925 850082 Fax: +(0)44 1925 850083

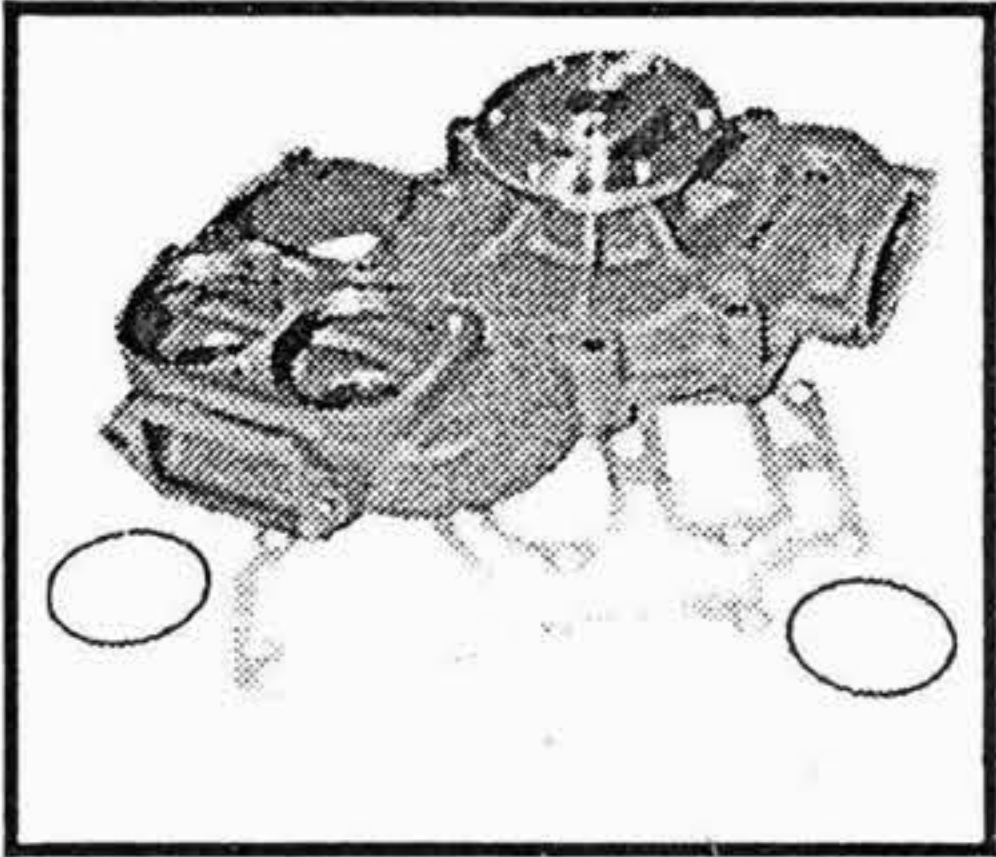
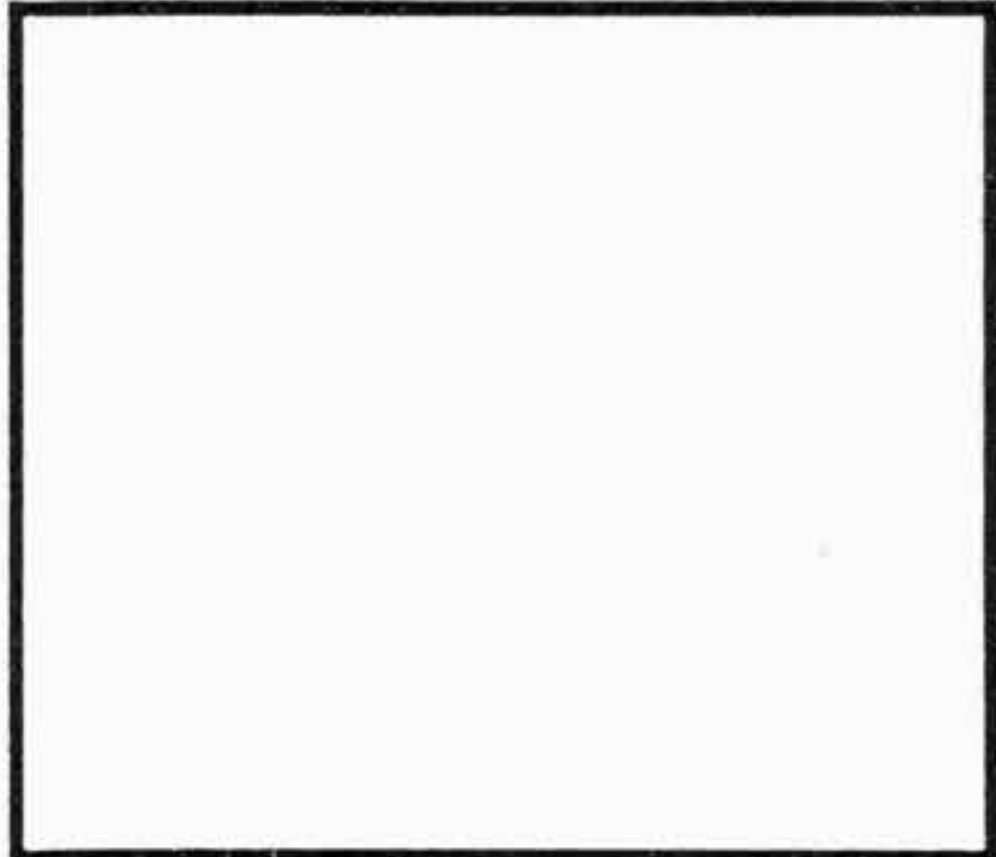
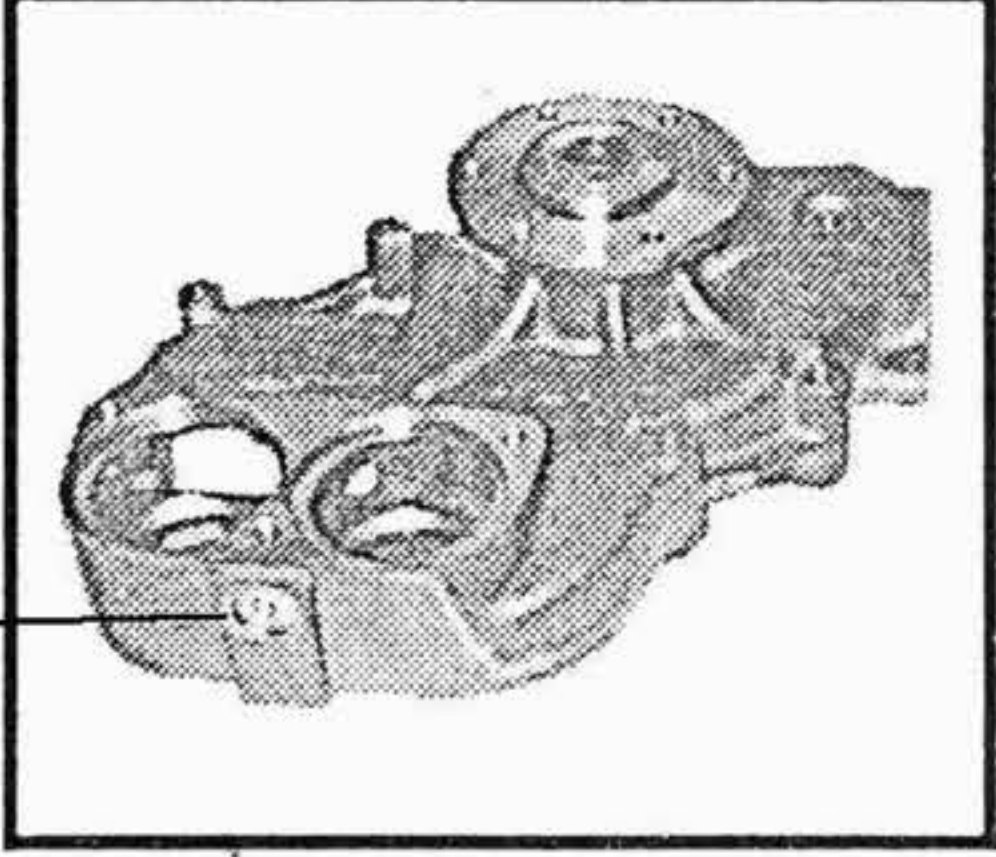
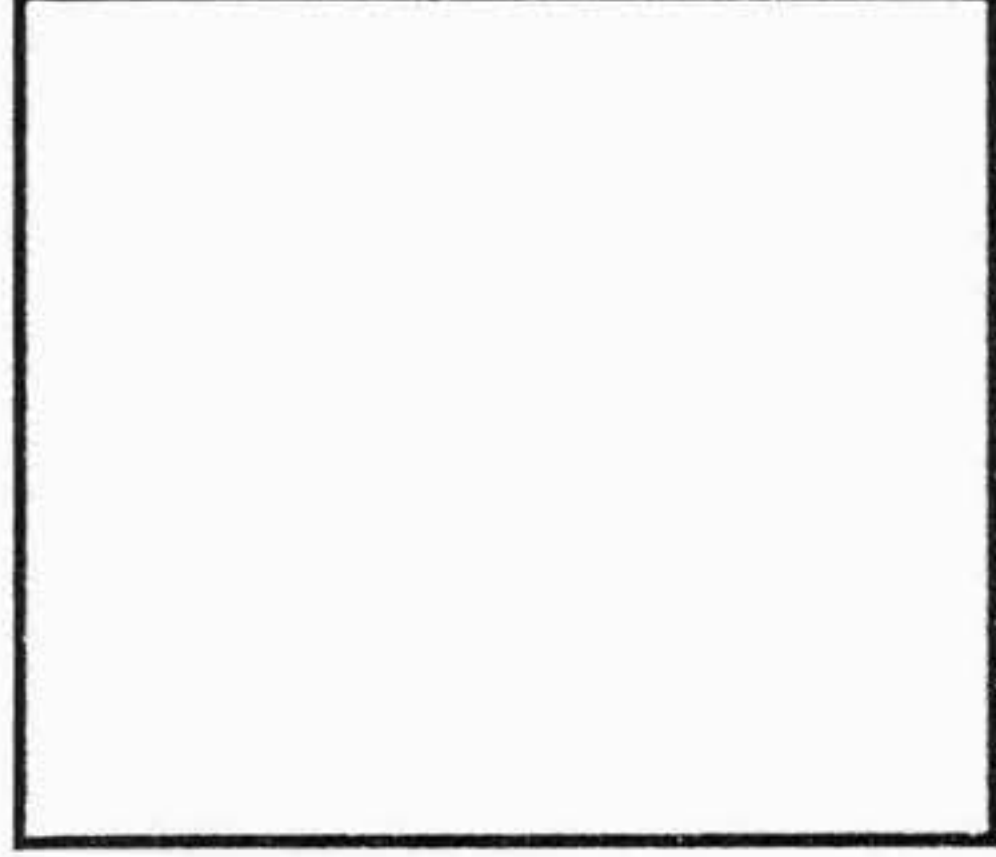
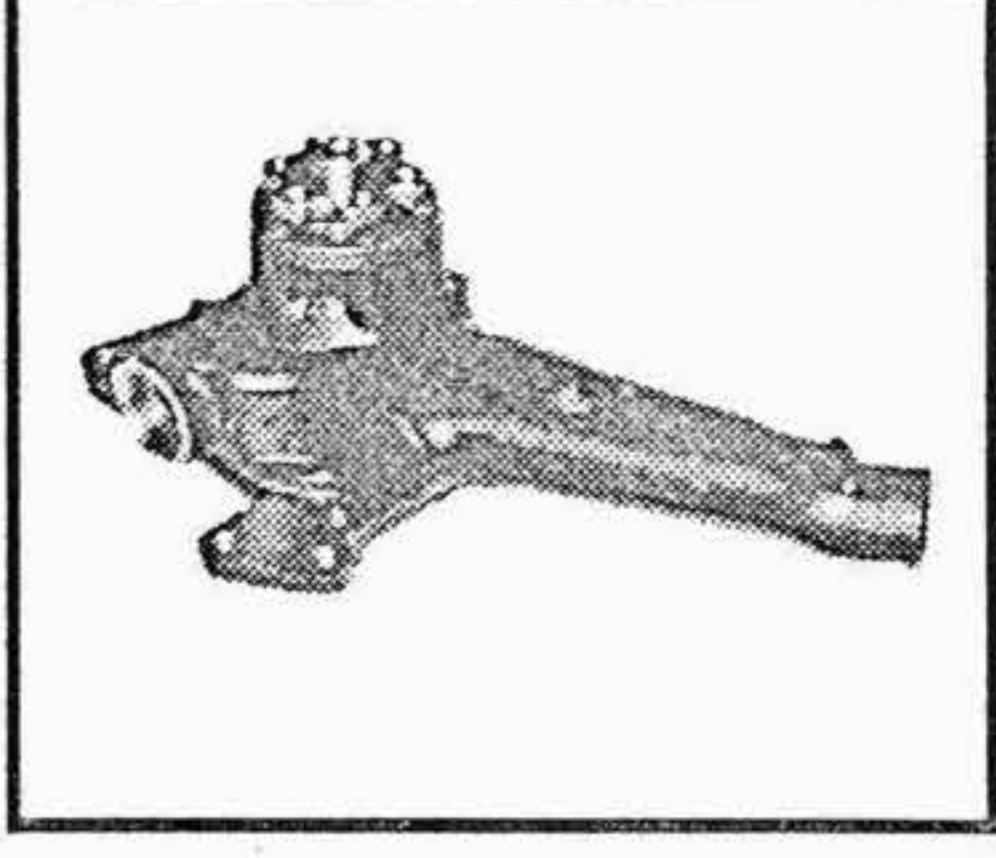
www.spwaterpumps.co.uk

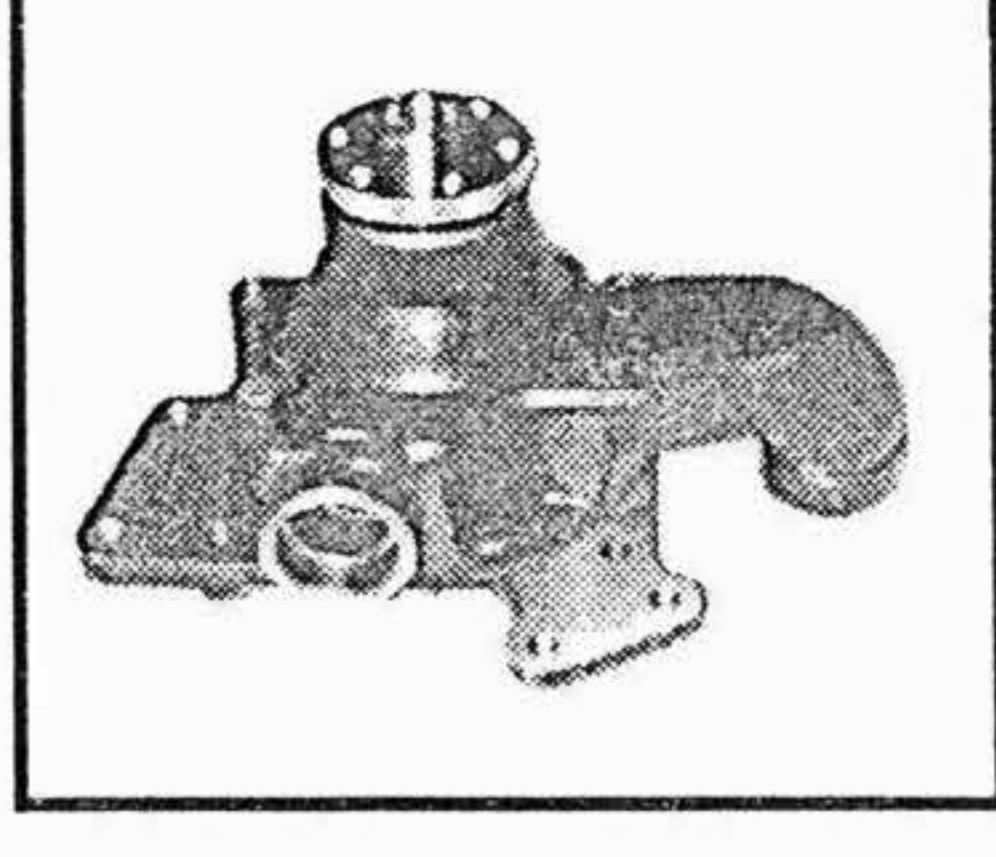

TIPO O MODELLO TYPE OU MODELE TYPE OR MODEL	MOTORE MOTEUR ENGINE	POMPA ACQUA POMPE A EAU WATER PUMP	KIT RIPARAZIONE NECESSAIRE DE REP. REPAIR KIT
<p>tutte le versioni con pompa iniezione a comando elettronico + RITARDATORE</p> <p>all version with electronic drive injection pump + RETARDER</p>	<p>OM 441 LA OM 442 LA</p>	<p>241.980 422.200.12.01</p>  <p>note : girante / impeller Ø 135 mm</p>	<p>242.237 422.200.04.04</p> 
<p>tutte le versioni con motore all version with engine</p> <p>NEW !!</p>	<p>OM 441 LA OM 442 LA</p> <p>Threaded Hole for Temperature Sensor</p>	<p>241.875 403.200.76.01</p>  <p>note : girante / impeller Ø 125 mm</p>	<p>242.181 422.200.03.04</p> 
<p>tutte le versioni con motore all version with engine</p> <p>NEW !!</p>	<p>OM366 / LA BRAZIL 1820</p>	<p>241.820 366.200.68.01</p> 	<p>242.249 366.200.08.04</p> 
<p>tutte le versioni con motore all version with engine</p> <p>NEW !!</p>	<p>OM366 / LA ECOLOGICO EPA 91 BRAZIL</p>	<p>241.880 376.200.05.01</p> 	<p>242.251 376.200.01.04</p> 

I ricambi non sono originali ma adattabili . Ogni riferimento originale é assolutamente indicativo .
Spare parts are not original but perfectly suitable . Every original part number has to be considered for reference purpose only .

SUITABLE

MERCEDES BENZ ENGINES

Tel:+44(0)1925 850082 Fax: +(0)44 1925 850083

www.spwaterpumps.co.uk



TIPO O MODELLO
TYPE OU MODELE
TYPE OR MODEL

MOTORE
MOTEUR
ENGINE

OMP REF. / O.E.M. REF

GUARNIZIONE IN METALLO PER METALLIC GASKET FOR

Pompa acqua / Water Pump

241.935 353.200.37.01

Kit di riparazione / Repair Kit

242.229 352.200.44.04

L / LA / LP / LAP 311 - 312

L / LA 322 - LF / LAF 323

L / LA / LP / LAP 327 - 328

710 - LF / LAF 710

L / LA / LP / LAP 911 - L / LA 911B

L / LA 1113 - LA 1313

1317 - LA 1513 - 1517 - 1813

OM 352

241.879

362.201.01.80

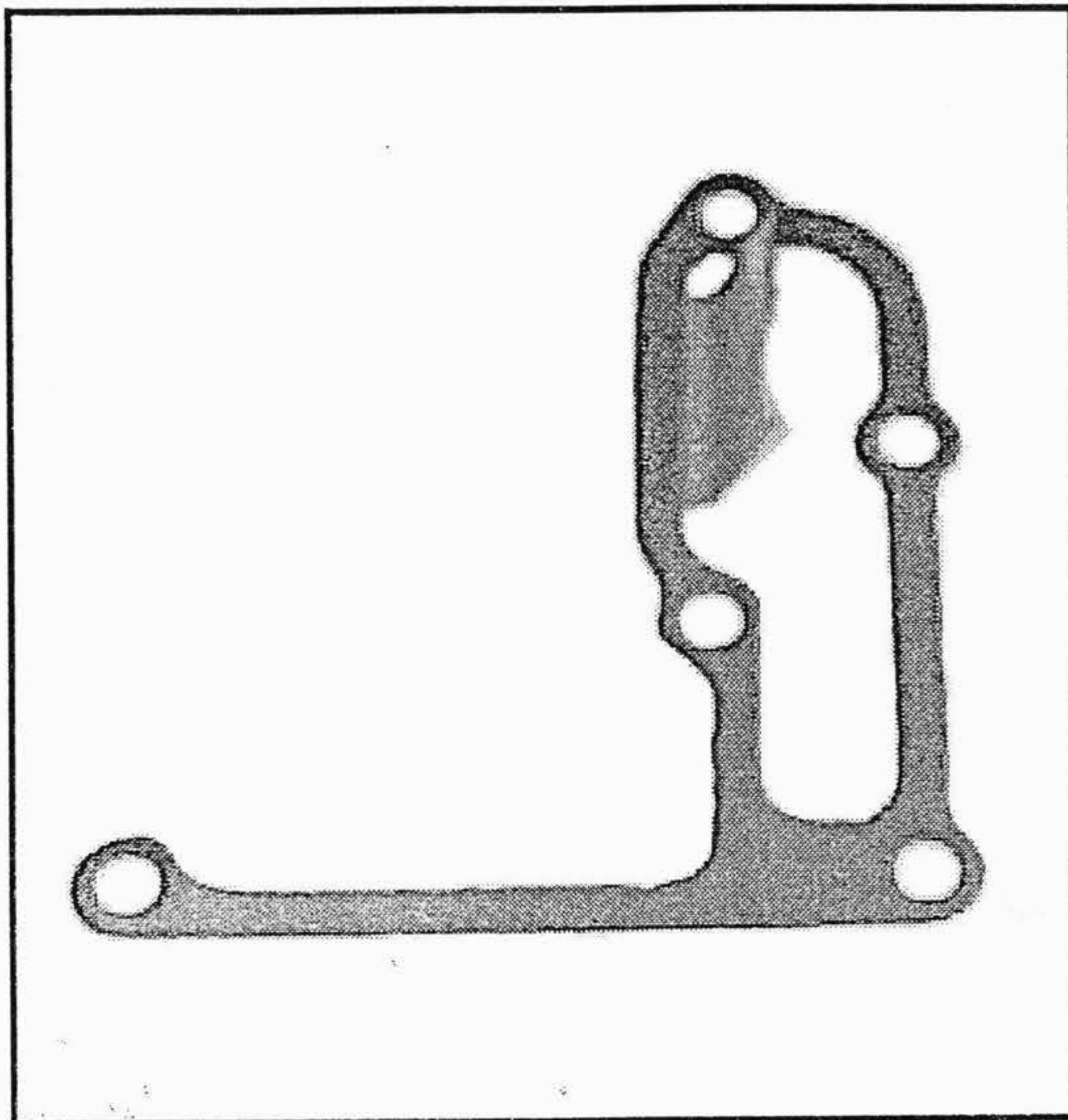

GUARNIZIONE IN METALLO PER METALLIC GASKET FOR

Pompa acqua / Water Pump

241.940 353.200.56.01

Kit di riparazione / Repair Kit

242.230 352.200.45.04

LP 810 - LP 813 - 911 B

1217 S - 1419 C / CL / L / LS

1420 - 1420 L - 1617 - 1619 C

1620 - 2219 - 2219 CL - 2220 - 2222

OM 352.985

OM 362

OM 362 LA

Pompa acqua / Water Pump

241.975 366.200.59.01

Kit di riparazione / Repair Kit

242.249 366.200.08.04

814 - 914 - 1114 - 1314 - 1414 - 1614

817 - 917 - 1117 - 1317

1417 - OH 1417 - 1517 - 1617

1017 - 1120 - 1320 - 1320 S - 1324

1419 C / CL / L / LS - 1520 - 1524

1617 - 1619 - 1620 - 1720 NAW

2219 - 2220 - 2222

OM 366

OM 366 A

OM 366 LA

Pompa acqua / Water Pump

241.985 366.200.60.01

Kit di riparazione / Repair Kit

242.249 366.200.08.04

817 - 917 - 1117 - 1317

1120 - 1320 - 1320 - 1520 - 1720 - 1820

OM 366 LA EURO II

241.878

366.201.01.80

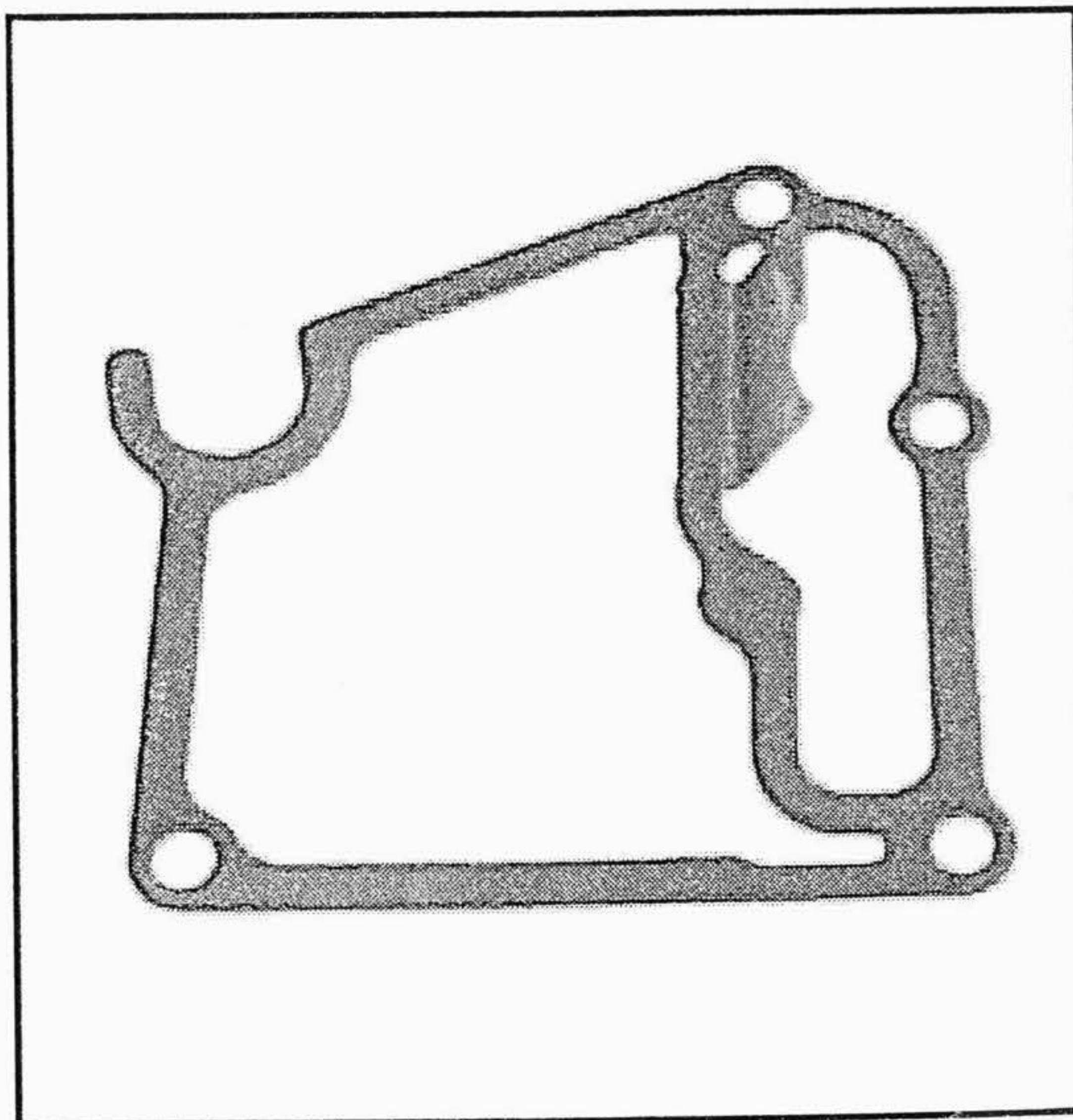

I ricambi non sono originali ma adattabili . Ogni riferimento originale é assolutamente indicativo .
Spare parts are not original but perfectly suitable . Every original part number has to be considered for reference purpose only .



SUITABLE

MERCEDES BENZ AUTOBUS - AUTOCARS - BUSES

Tel: +44(0)1925 850082 Fax: +(0)44 1925 850083

www.spwaterpumps.co.uk

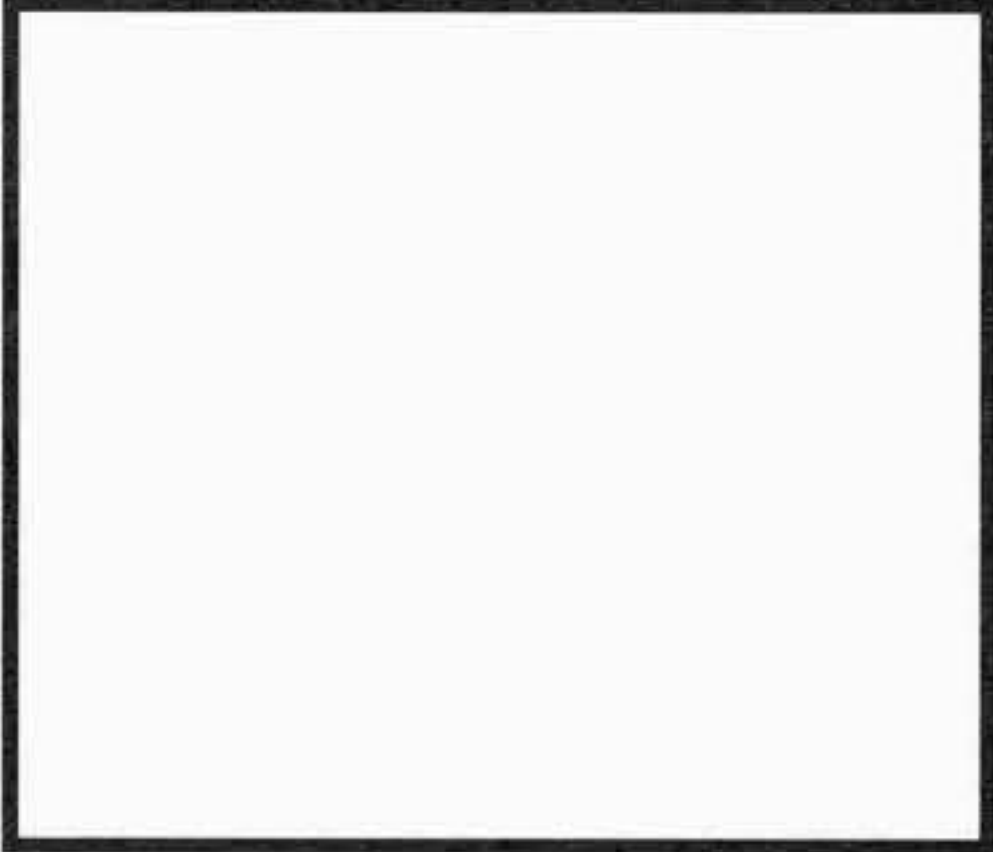
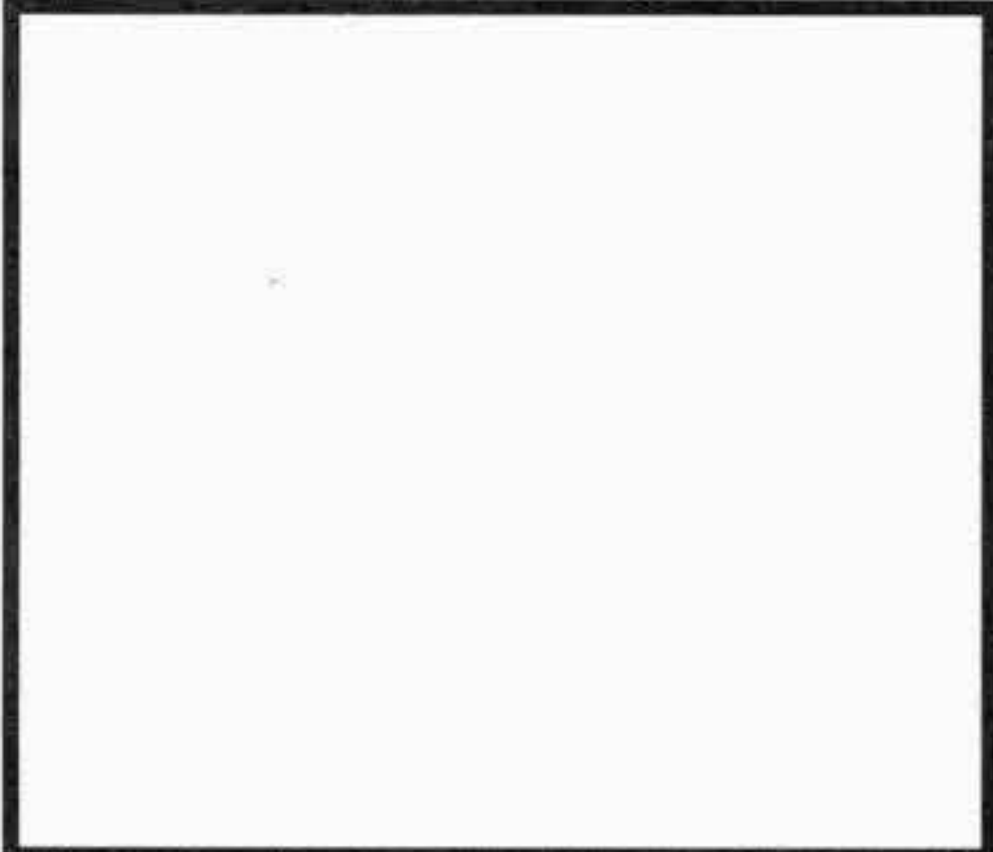
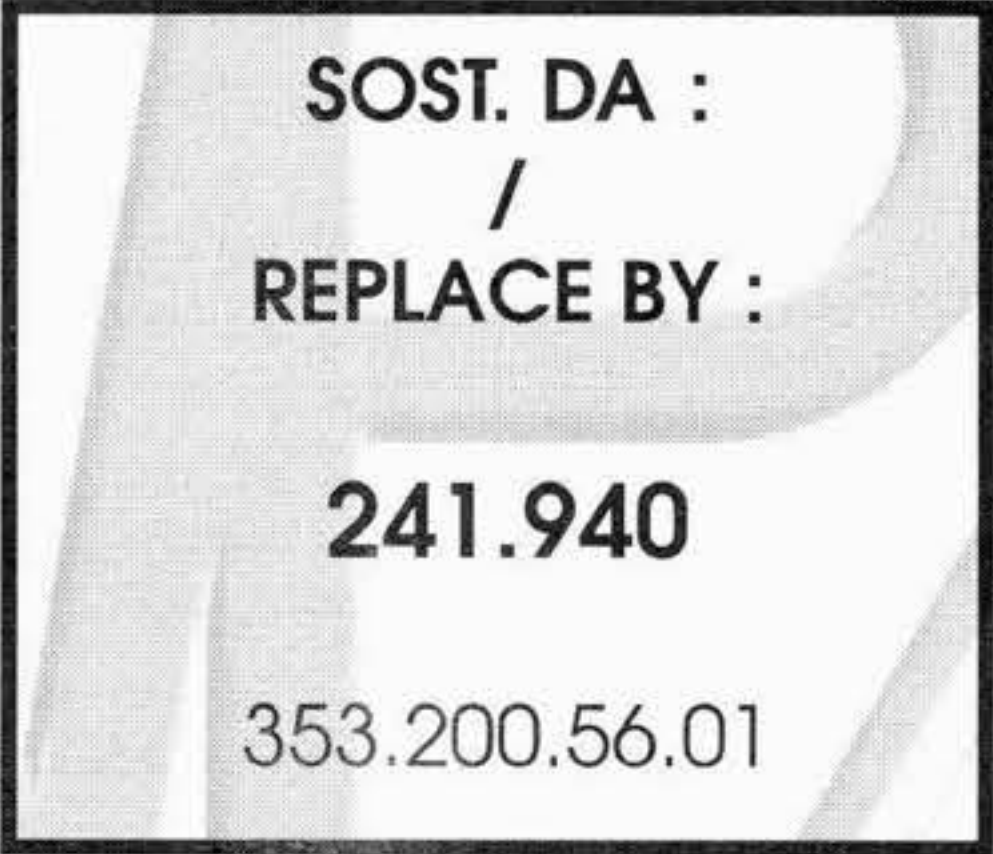
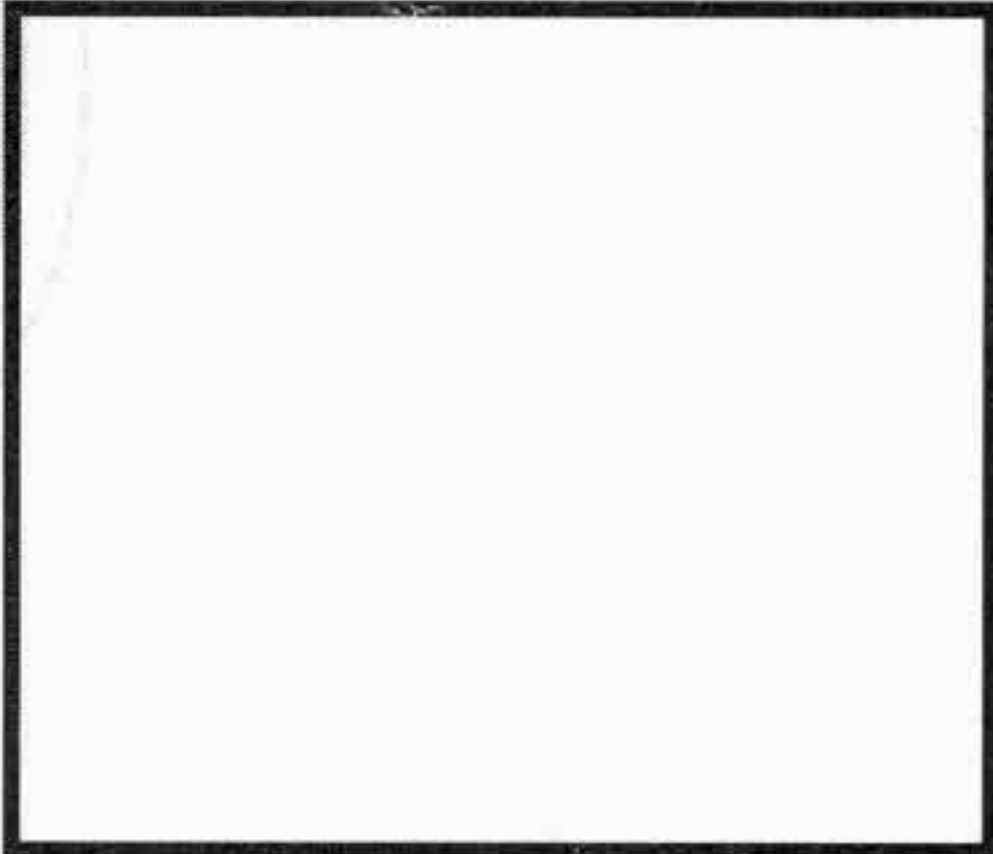
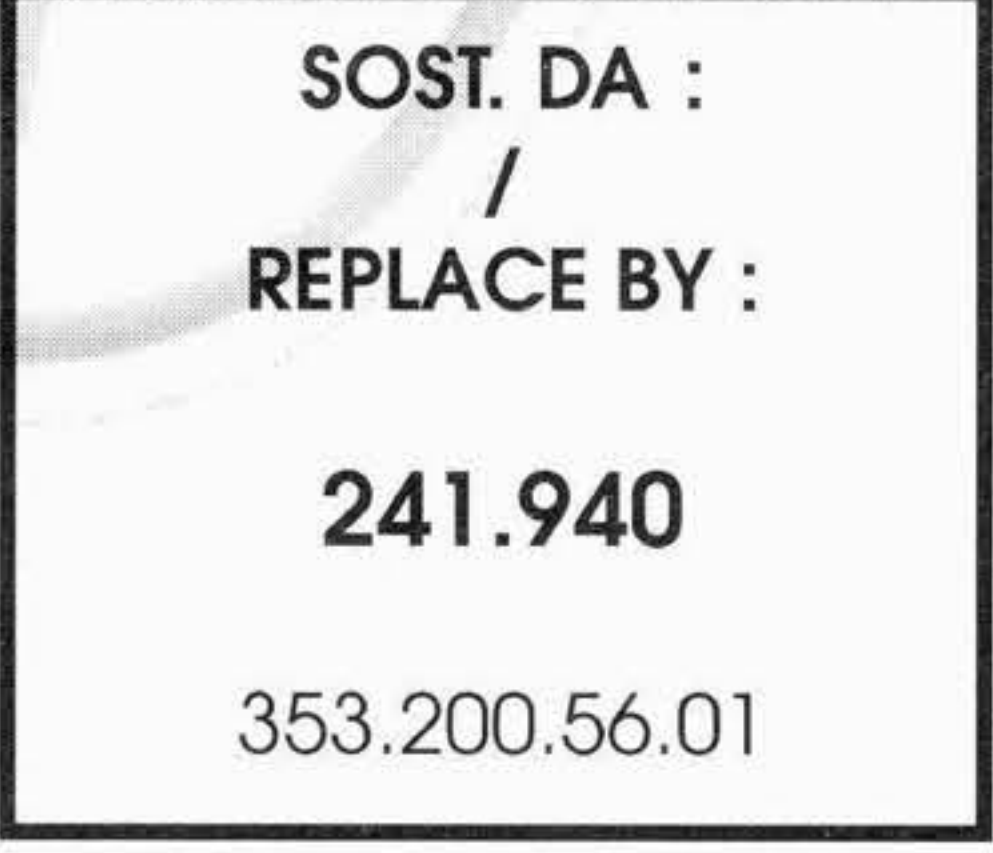
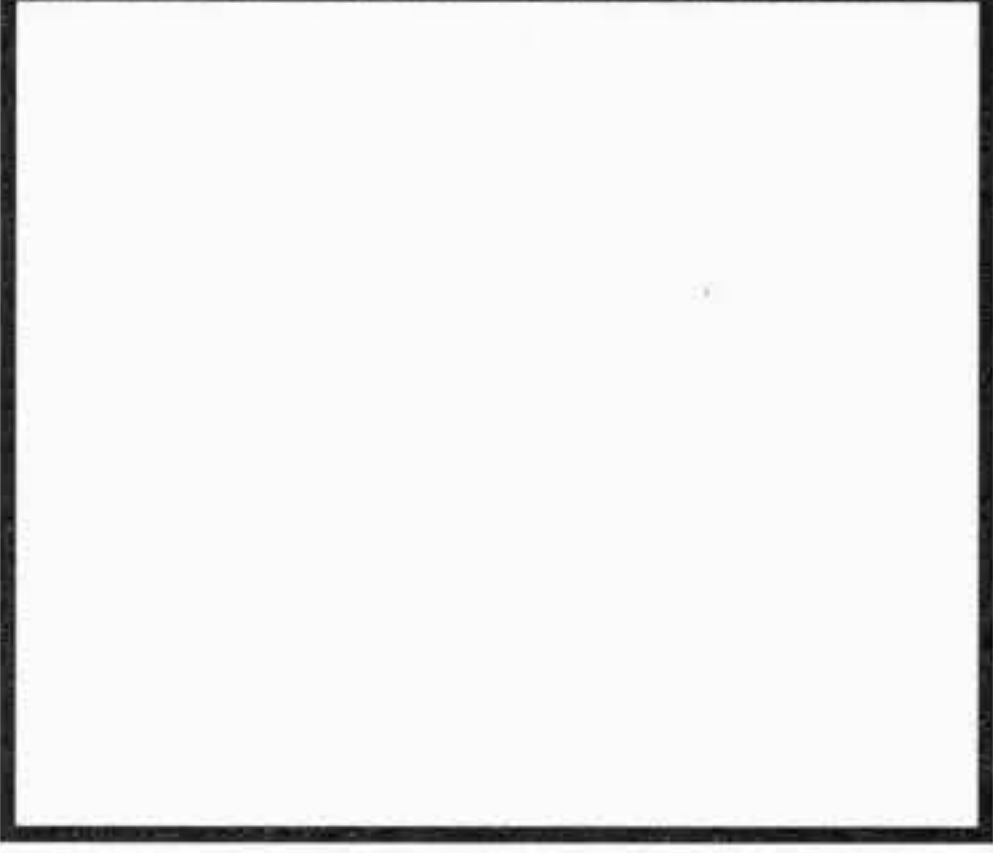
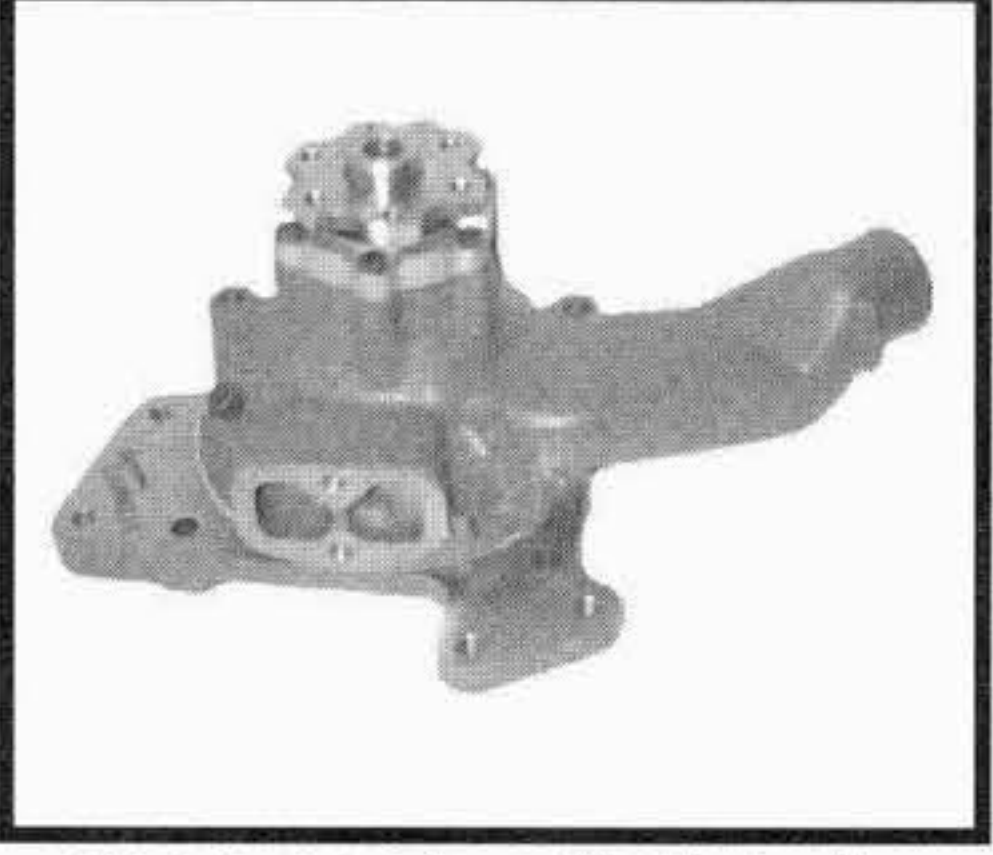

TIPO O MODELLO TYPE OU MODELE TYPE OR MODEL	MOTORE MOTEUR ENGINE	POMPA ACQUA POMPE A EAU WATER PUMP OMP REF. / O.EM. REF	KIT RIPARAZIONE NECESSAIRE DE REP. REPAIR KIT OMP REF. / O.EM. REF
O 317	OM 326 OM 346 H	<p>241.845 346.200.10.01</p>  <p>girante / impeller Ø 90 mm</p>	<p>242.074 346.200.00.04</p> 
O 302 O 309 D	OM 352 BM 352 --> mot. 049763 BM 353 --> mot. 441885 OM 352 --> mot. 441885	<p>--- 352.200.95.01</p>  <p>SOST. DA : / REPLACE BY : 241.940 353.200.56.01</p> <p>albero senza foro filettato / shaft without threaded bore girante / impeller Ø 87 mm</p>	<p>242.205 352.200.39.04</p> 
O 302 O 309 D	OM 352 BM 352 mot. 049764 --> BM 353 mot. 441886 --> OM 352 mot. 441886 -->	<p>--- 352.200.96.01</p>  <p>SOST. DA : / REPLACE BY : 241.940 353.200.56.01</p> <p>albero senza foro filettato / shaft without threaded bore girante / impeller Ø 95 mm</p>	<p>242.164 352.200.41.04</p> 
O 302 O 309 D	OM 352 BM 352 BM 353 OM 352	<p>241.940 353.200.56.01</p>  <p>albero con foro filettato / shaft with threaded bore girante / impeller Ø 95 mm</p>	<p>242.230 352.200.45.04</p> 

I ricambi non sono originali ma adattabili . Ogni riferimento originale é assolutamente indicativo .
Spare parts are not original but perfectly suitable . Every original part number has to be considered for reference purpose only .





SUITABLE

MERCEDES BENZ AUTOBUS - AUTOCARS - BUSES

Tel:+44(0)1925 850082 Fax: +(0)44 1925 850083

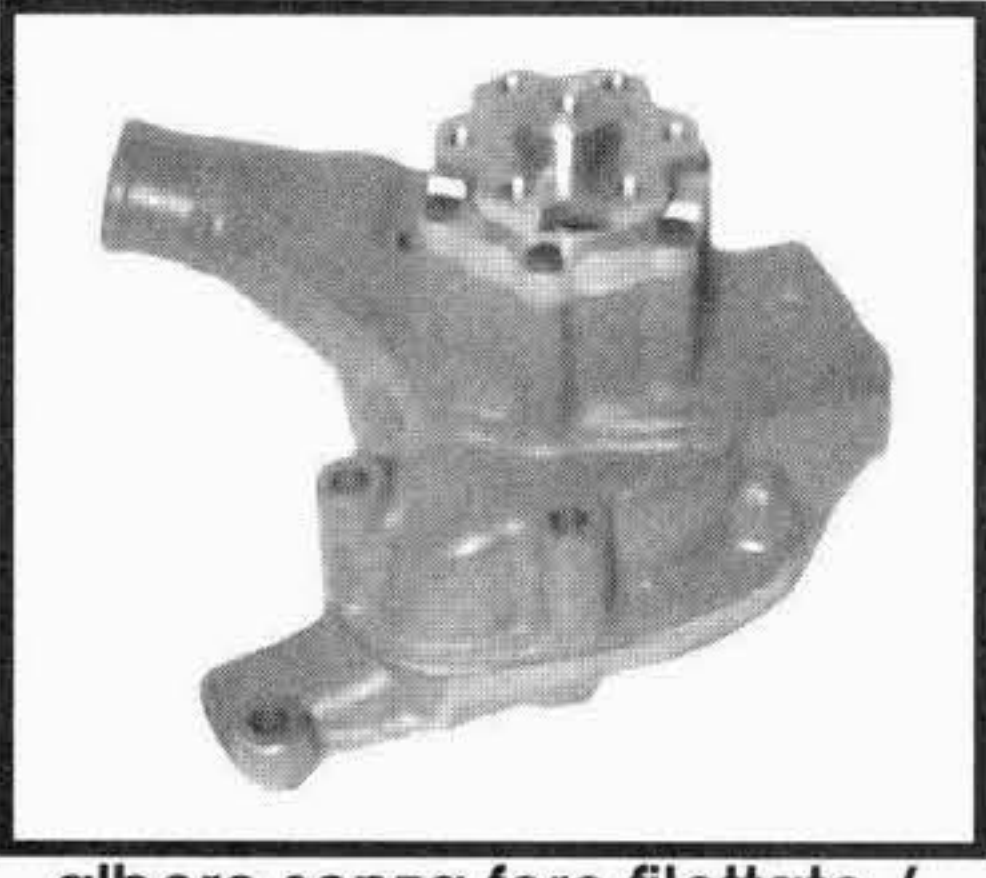
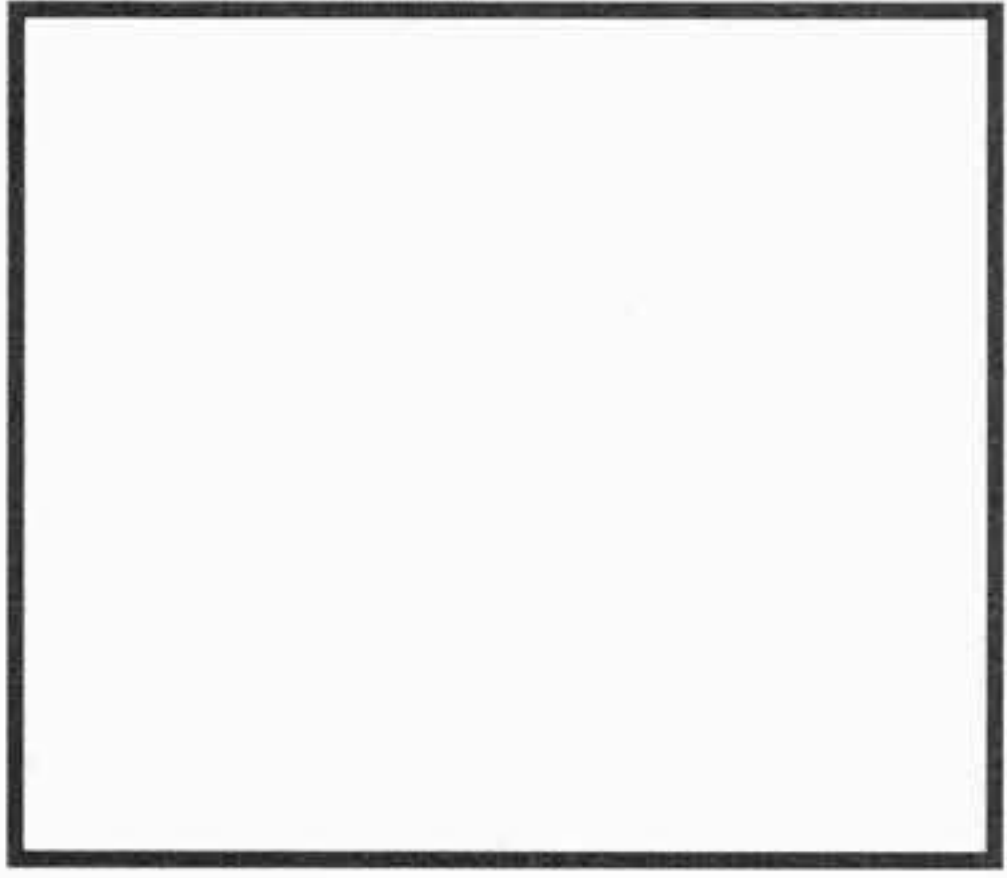
www.spwaterpumps.co.uk

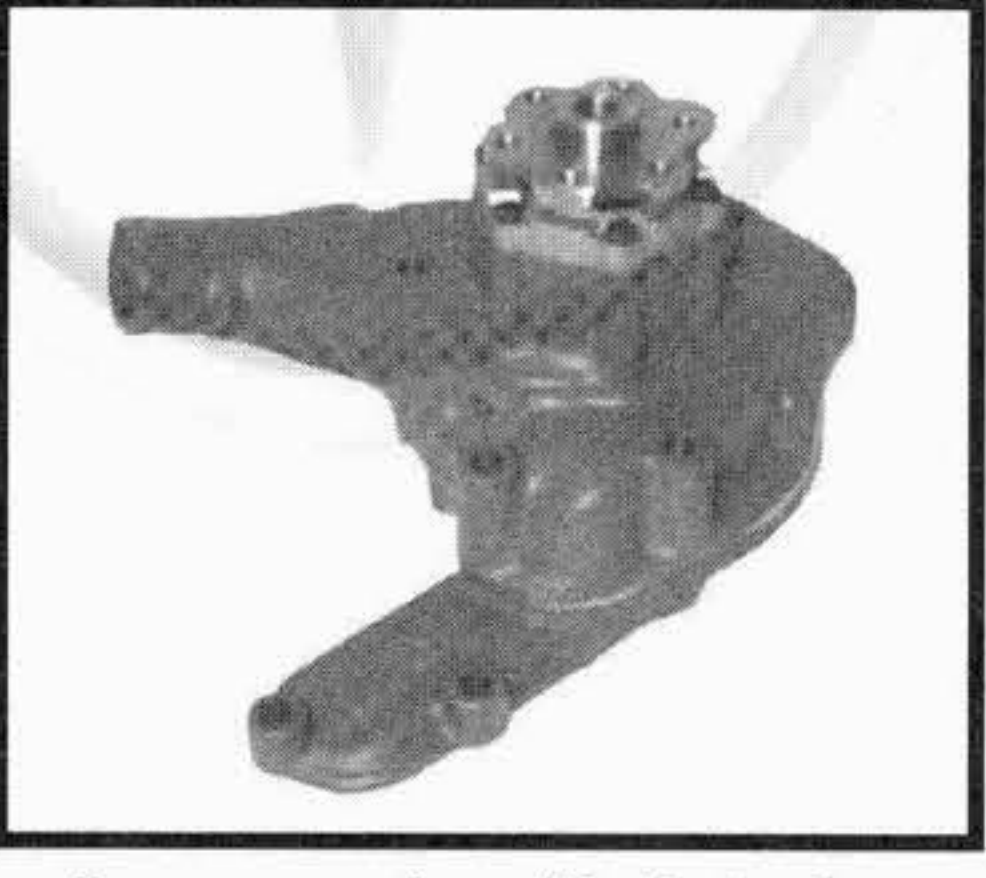

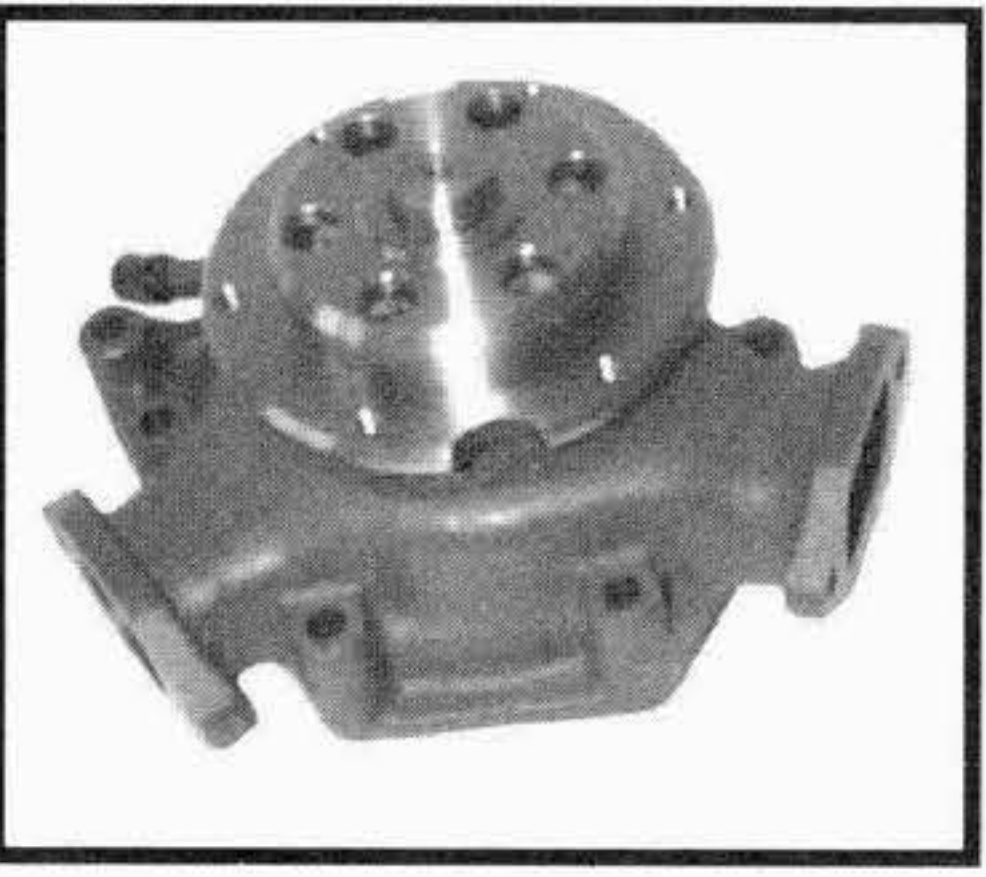
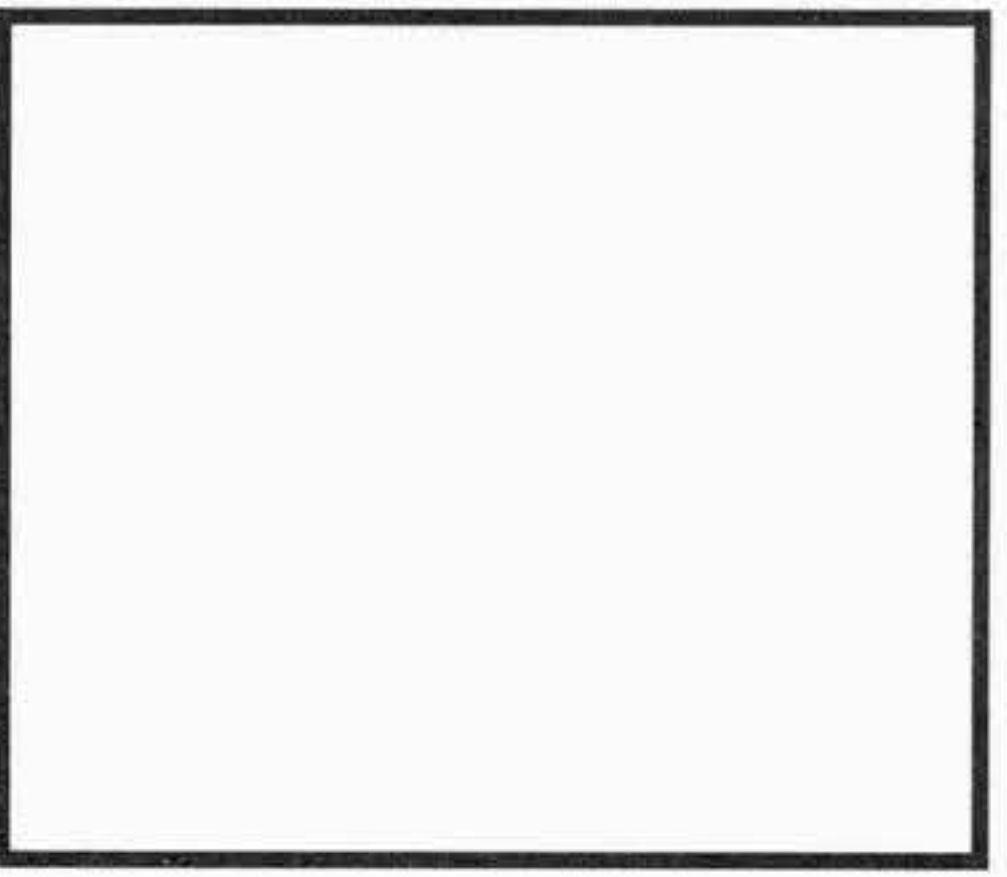
TIPO O MODELLO TYPE OU MODELE TYPE OR MODEL	MOTORE MOTEUR ENGINE	POMPA ACQUA POMPE A EAU WATER PUMP OMP REF. / O.EM. REF	KIT RIPARAZIONE NECESSAIRE DE REP. REPAIR KIT OMP REF. / O.EM. REF
O 321 H O 321 HL O 322	OM 352 --> mot. 034435	<p>241.790 353.200.40.01</p>  <p>albero senza foro filettato / shaft without threaded bore girante / impeller Ø 87 mm</p>	<p>242.191 352.200.38.04</p> 
O 321 H O 321 HL O 322	OM 352 mot. 034436 -->	<p>--- 353.200.36.01</p> <div style="border: 1px solid black; padding: 5px; text-align: center;"> <p>SOST. DA : / REPLACE BY :</p> <p>241.935</p> <p>353.200.37.01</p> </div> <p>albero con foro filettato / shaft with threaded bore girante / impeller Ø 95 mm</p>	<p>242.229 352.200.44.04</p> 
O 321 H O 321 HL O 322	OM 352	<p>241.935 353.200.37.01</p>  <p>albero con foro filettato / shaft with threaded bore girante / impeller Ø 95 mm</p>	<p>242.229 352.200.44.04</p> 
O 302 MEXICO O 302 O 322 YUGOSLAVIA	OM 355 A OM 355	<p>241.800 355.200.08.01</p>  <p>girante / impeller Ø 115 mm</p>	<p>242.076 355.200.13.04</p> 

I ricambi non sono originali ma adattabili . Ogni riferimento originale é assolutamente indicativo .
Spare parts are not original but perfectly suitable . Every original part number has to be considered for reference purpose only .







SUITABLE

MERCEDES BENZ AUTOBUS - AUTOCARS - BUSES

Tel: +44(0)1925 850082 Fax: +(0)44 1925 850083

www.spwaterpumps.co.uk



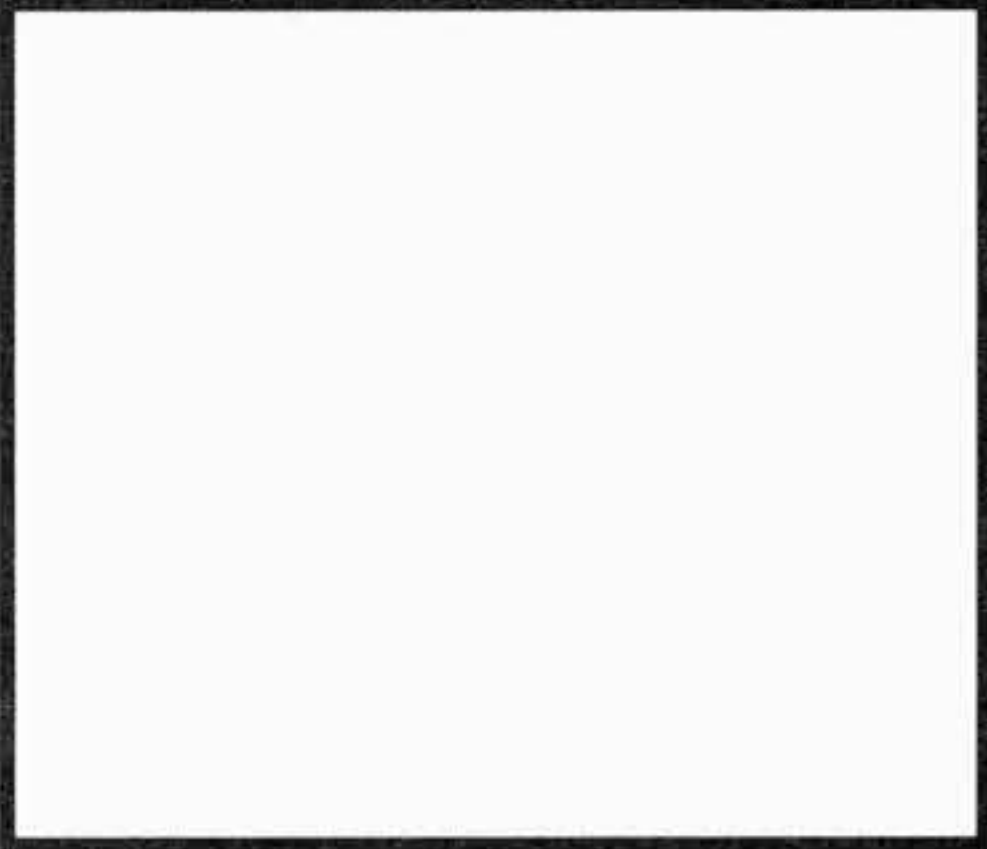

TIPO O MODELLO TYPE OU MODELE TYPE OR MODEL	MOTORE MOTEUR ENGINE	POMPA ACQUA POMPE A EAU WATER PUMP OMP REF. / O.EM. REF	KIT RIPARAZIONE NECESSAIRE DE REP. REPAIR KIT OMP REF. / O.EM. REF
O 302 MEXICO O 302 O 322 YUGOSLAVIA	OM 355 A OM 355	<p>241.890 355.200.09.01</p>  <p>girante / impeller Ø 120 mm</p>	<p>242.161 355.200.14.04</p> 
O 302 MEXICO O 302 O 322 YUGOSLAVIA	OM 355 A OM 355	<p>241.905 355.200.15.01</p>  <p>con albero cuscinetto / with shaft bearing girante / impeller Ø 120 mm</p>	<p>242.212 355.200.12.04</p> 
O 317	OM 355 H	<p>241.760 355.200.00.01</p> 	<p>242.074 355.200.05.04</p> 
O 355 O 364	OM 355 BRAZIL	<p>241.955 345.200.71.01</p>  <p>con albero cuscinetto / with shaft bearing girante / impeller Ø 120 mm</p>	<p>242.161 355.200.14.04</p> 

MERCEDES BENZ AUTOBUS - AUTOCARS - BUSES

Tel: +44(0)1925 850082 Fax: +(0)44 1925 850083

www.spwaterpumps.co.uk

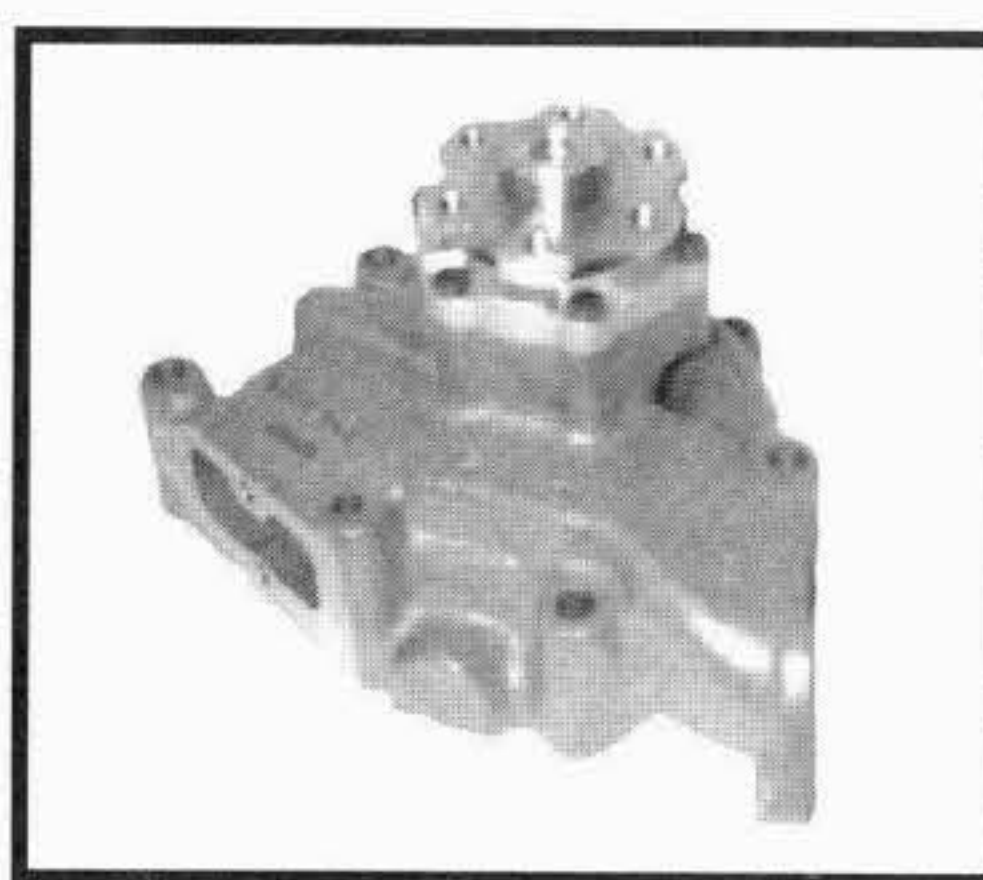
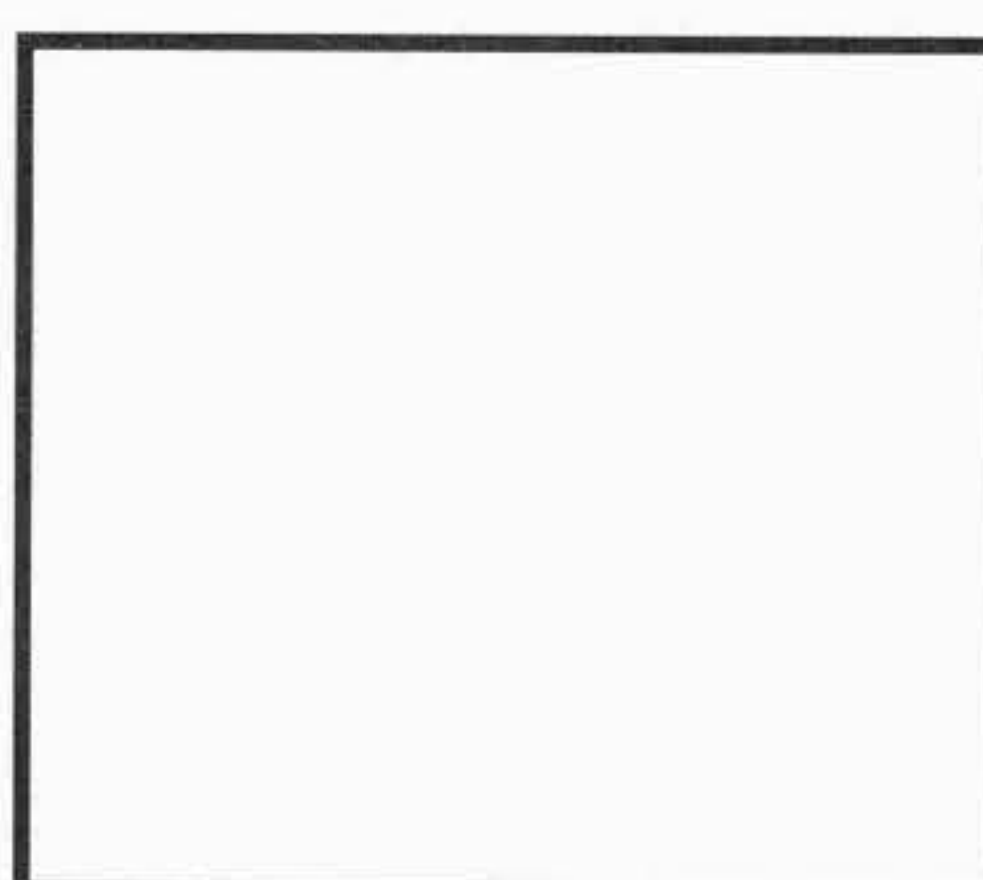
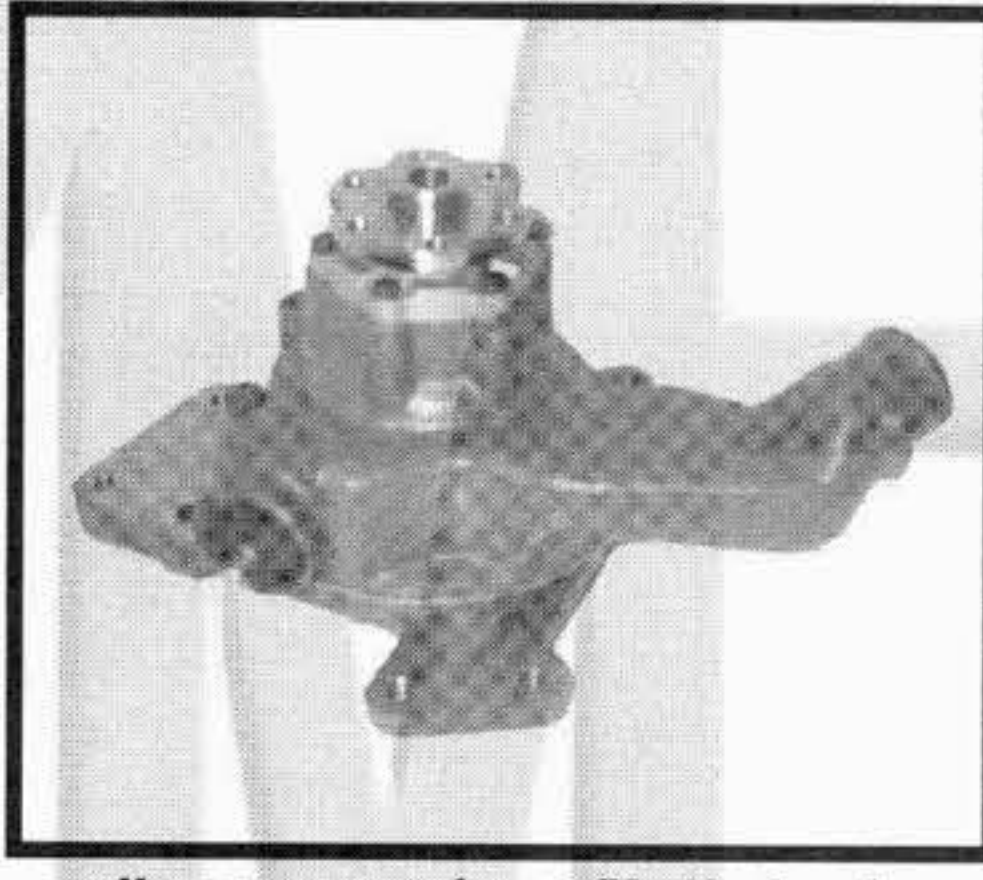
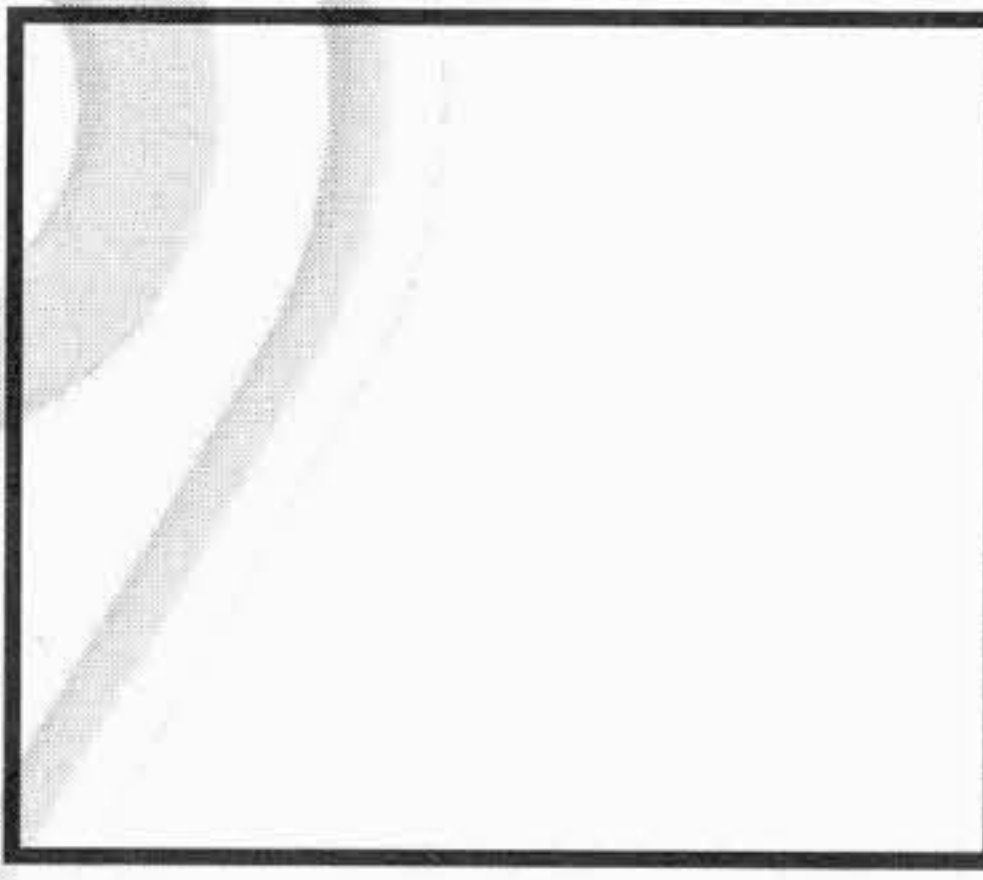
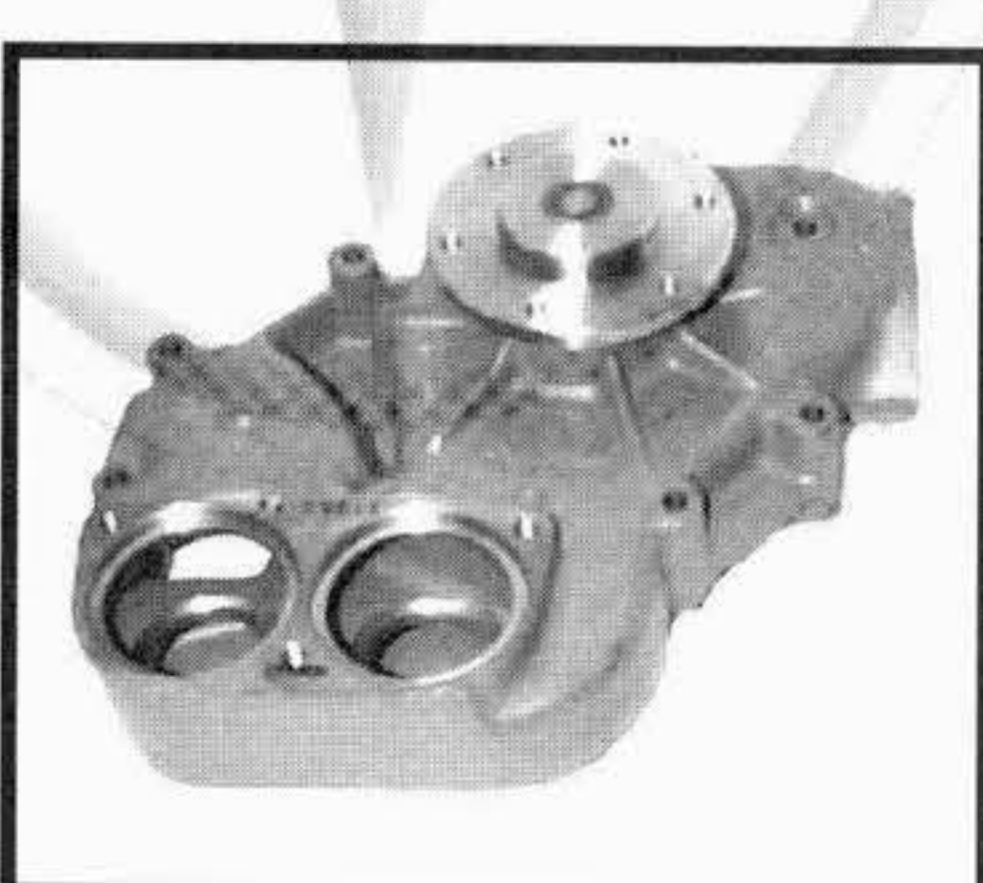

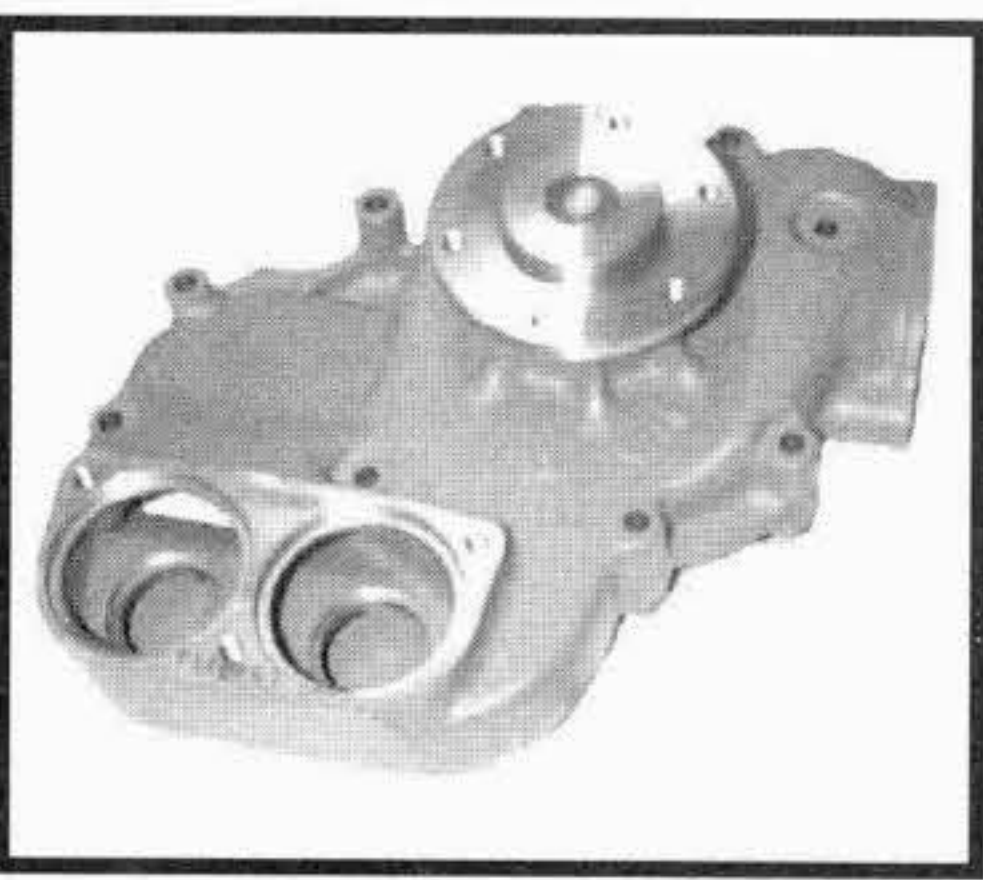
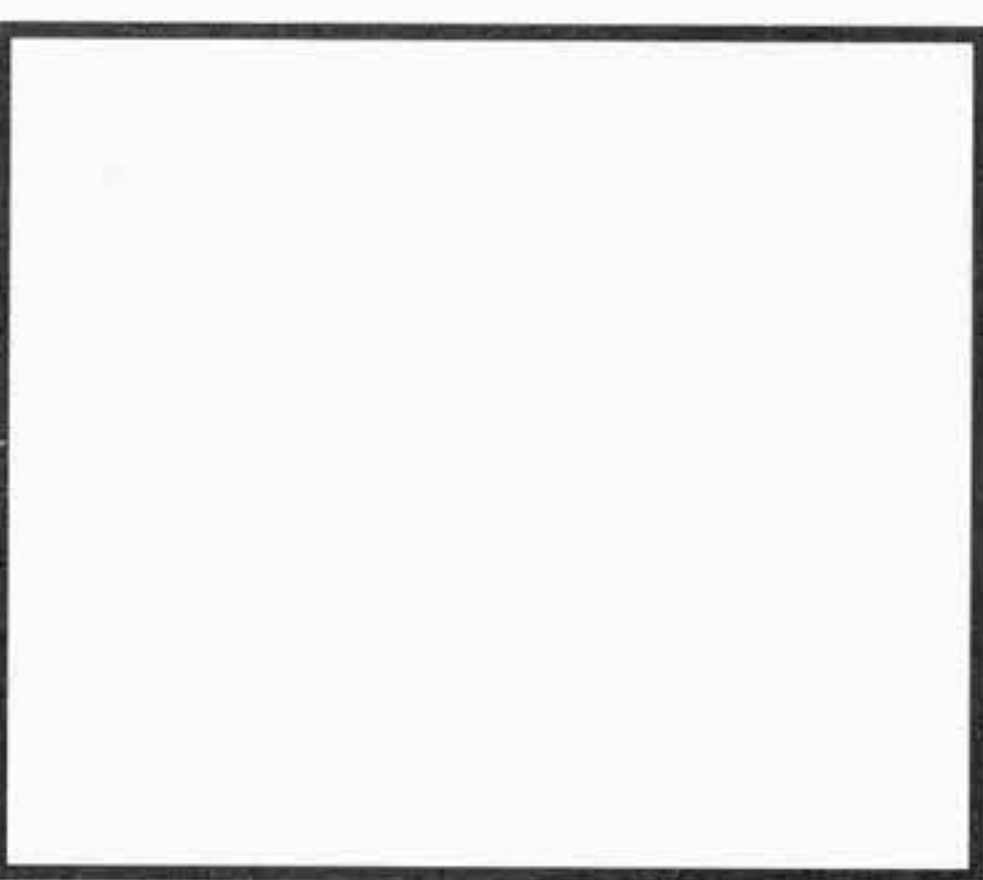
TIPO O MODELLO TYPE OU MODELE TYPE OR MODEL	MOTORE MOTEUR ENGINE	POMPA ACQUA POMPE A EAU WATER PUMP OMP REF. / O.EM. REF	KIT RIPARAZIONE NECESSAIRE DE REP. REPAIR KIT OMP REF. / O.EM. REF
O 302 O 305	OM 360	241.740 360.200.46.01  albero con foro filettato / shaft with threaded bore	242.058 360.200.07.04 
O 301 O 402	OM 366 OM 366 A OM 366 OM 366 A	241.975 366.200.59.01  albero con foro filettato / shaft with threaded bore girante / impeller Ø 95 mm	242.249 366.200.08.04 
O 303 O 303 O 303 O 305 - O 305 G - O 307	OM 401 --> mot. 129660 OM 402 --> mot. 129660 OM 403 --> mot. 129660 OM 407 H 905/908/909/910/911 913/914/915/916/918 --> mot. 017497	241.825 403.200.70.01  note : girante / impeller Ø 125 mm	242.181 422.200.03.04 
O 303 O 303 O 303 O 303 O 303 O 305 - O 305 G - O 307 O 303 O 405 ST	OM 401 mot. 129661 -> OM 402 mot. 129661 -> OM 403 mot. 129661 -> OM 421 - 421 A OM 422 - 422A OM 407 H 905/908/909 910/911/913/914/915/916/918 mot. 017498 --> OM 441 - 441 A --> mot. 504397 OM 442 - 442 A OM 427 H.910	241.835 403.200.71.01  note : girante / impeller Ø 125 mm	242.181 422.200.03.04 

I ricambi non sono originali ma adattabili . Ogni riferimento originale é assolutamente indicativo .
Spare parts are not original but perfectly suitable . Every original part number has to be considered for reference purpose only .







SUITABLE

MERCEDES BENZ AUTOBUS - AUTOCARS - BUSES

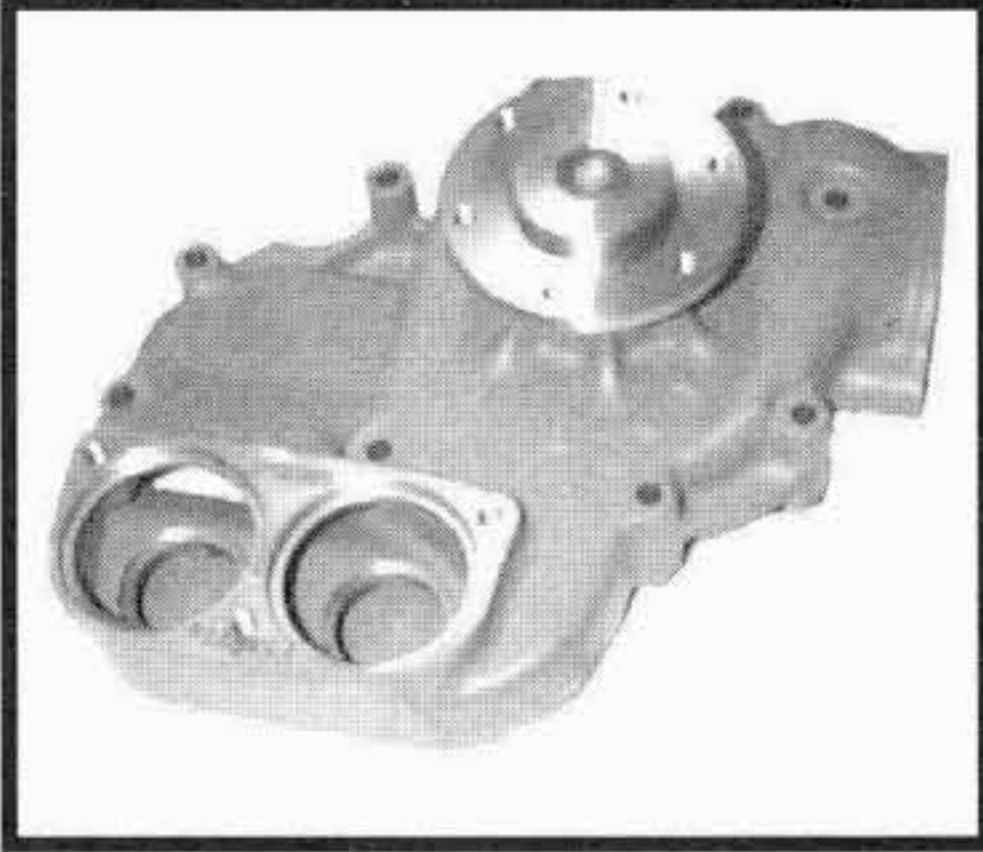
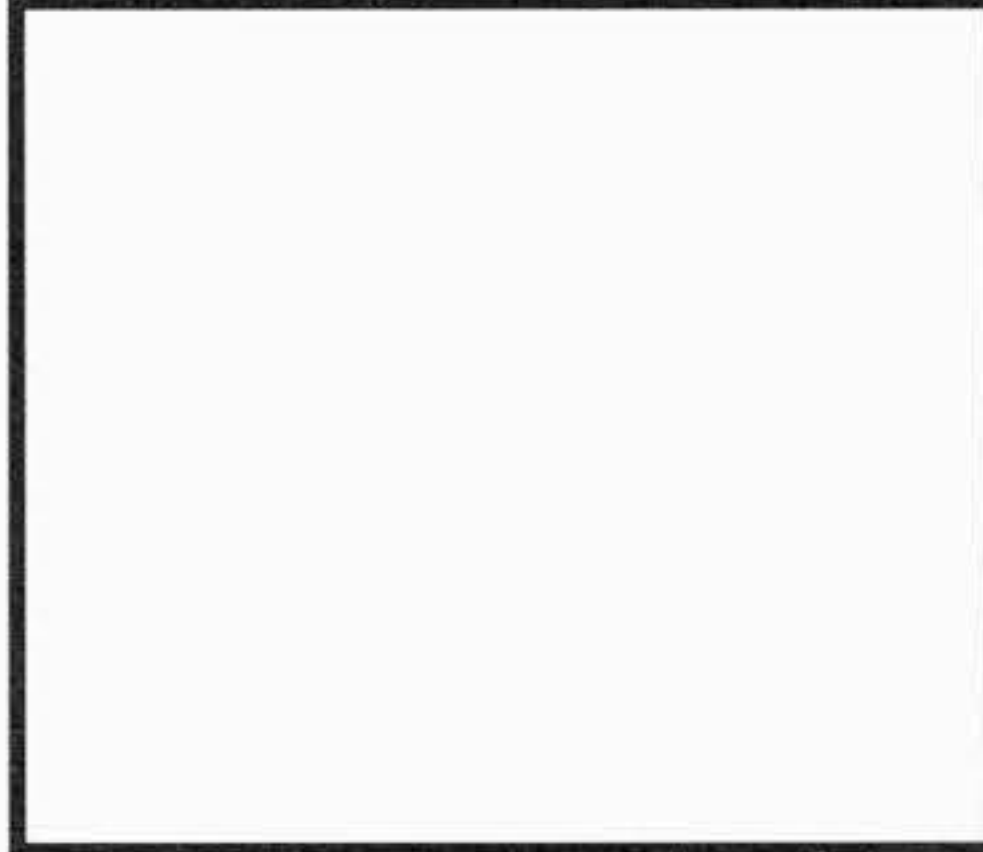
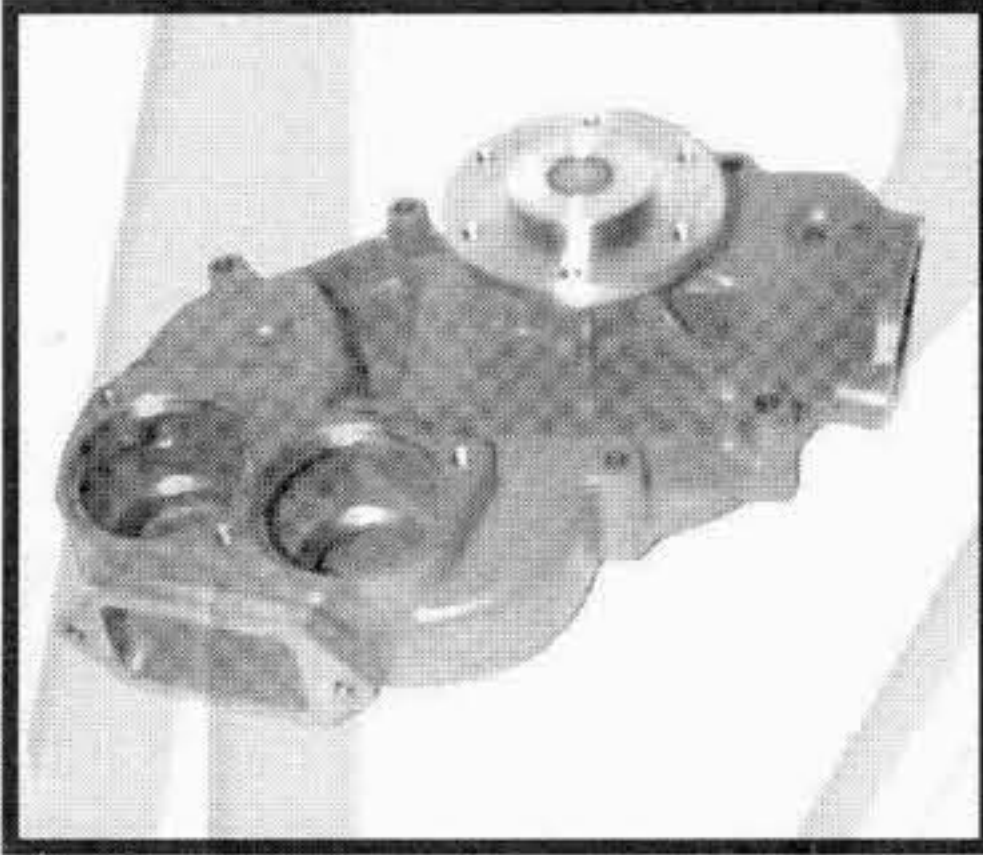
Tel: +44(0)1925 850082 Fax: +44(0)1925 850083

www.spwaterpumps.co.uk

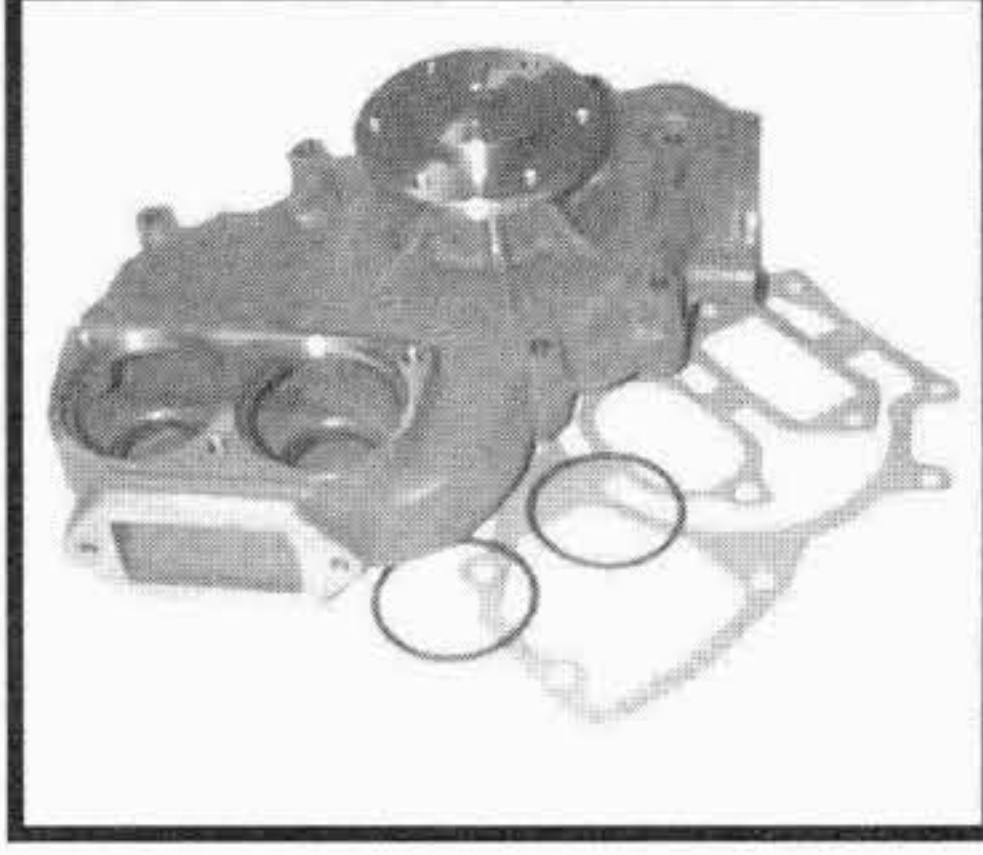

TIPO O MODELLO TYPE OU MODELE TYPE OR MODEL	MOTORE MOTEUR ENGINE	POMPA ACQUA POMPE A EAU WATER PUMP OMP REF. / O.EM. REF	KIT RIPARAZIONE NECESSAIRE DE REP. REPAIR KIT OMP REF. / O.EM. REF
O 303	OM 441 - 441 A mot. 504398 --> OM 442 - 442 A	241.995 441.200.02.01 	242.265 441.200.01.04 
O 303 O 305 - O 305 G O 305 G O 307 AUTOBUS CON CAMBIO AUTOMATICO E RITARDATEUR AUTOCARS AVEC BOITE DE VITESSE AUTOMATIQUE ET RETARDATEUR BUSES WITH AUTOMATIC GEARBOX AND RETARDER	OM 401.901/.917 --> mot. 129660 OM 407 AH.955 OM 407 H.919 --> mot. 017497 OM 407 AH.955	241.840 403.200.72.01  note : girante / impeller Ø 125 mm	242.181 422.200.03.04 
O 303 O 303 O 305 G O 405 O 405 - O 405 G O 405 ST O 407 GTD - O 407 U AUTOBUS CON CAMBIO AUTOMATICO E RITARDATEUR AUTOCARS AVEC BOITE DE VITESSE AUTOMATIQUE ET RETARDATEUR BUSES WITH AUTOMATIC GEARBOX AND RETARDER	OM 401.901/.917 mot. 129661 --> OM 402.907 / 918 OM 421.908 OM 422.908 / 951 OM 407 AH.951 mot. 017498 --> OM 427 HA/.950 OM 447 H - HA OM 427 H - OM 447 H OM 447 H 14mm Hole	241.895 403.200.73.01  note : girante / impeller Ø 125 mm	242.181 422.200.03.04 
TUTTI I MODELLI ALL MODELS AUTOBUS CON CAMBIO AUTOMATICO E RITARDATEUR AUTOCARS AVEC BOITE DE VITESSE AUTOMATIQUE ET RETARDATEUR BUSES WITH AUTOMATIC GEARBOX AND RETARDER	OM 422 --> mot. 146024	241.970 422.200.11.01  note : girante / impeller Ø 135 mm	242.237 422.200.04.04 

I ricambi non sono originali ma adattabili . Ogni riferimento originale é assolutamente indicativo .



Spare parts are not original but perfectly suitable . Every original part number has to be considered for reference purpose only .

MERCEDES BENZ

Tel: +44(0)1925 850082 Fax: +(0)44 1925 850083

www.spwaterpumps.co.uk

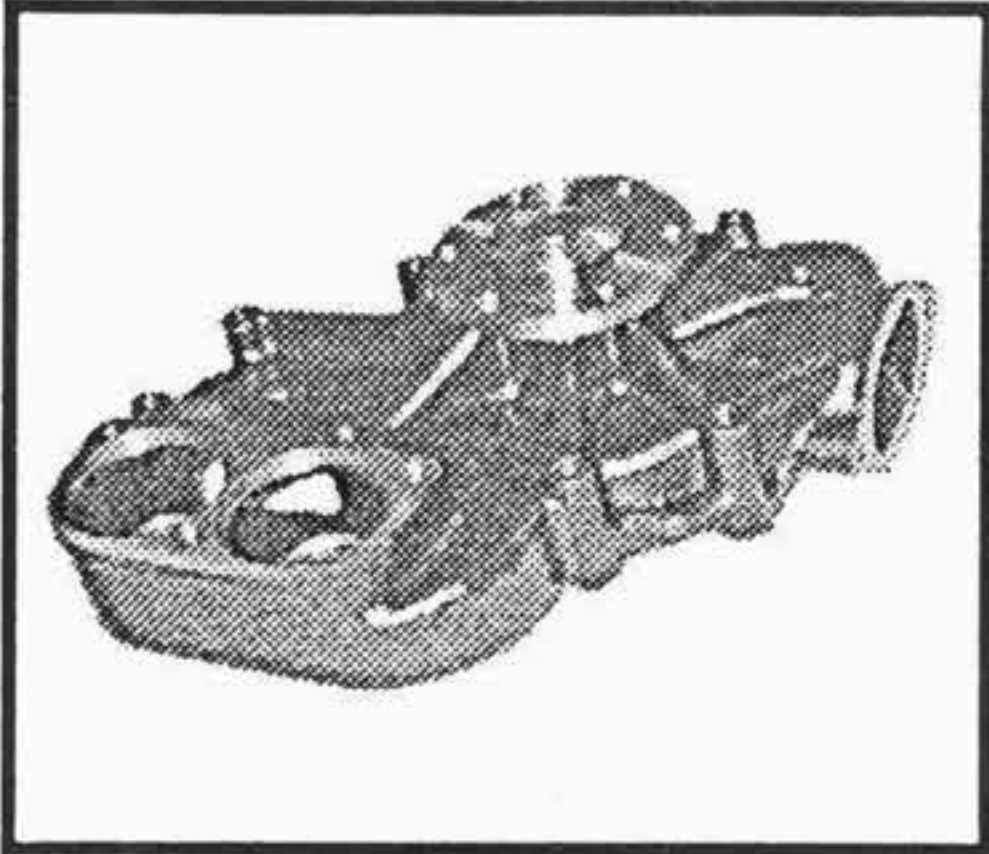
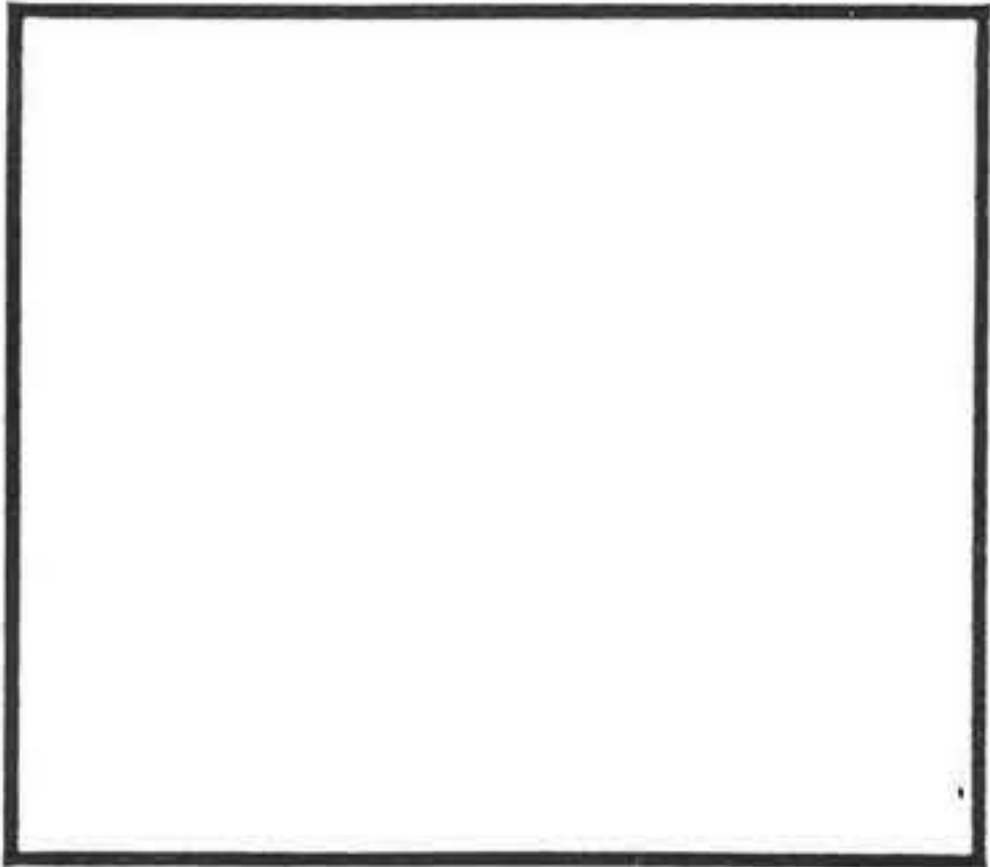
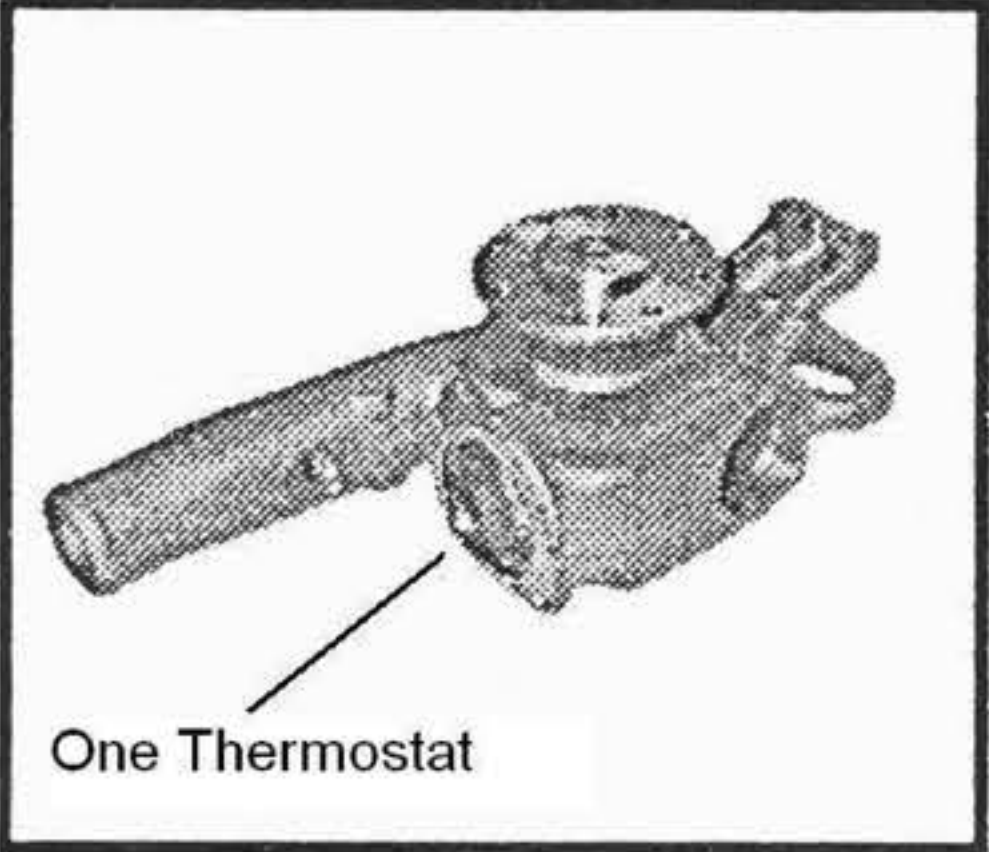

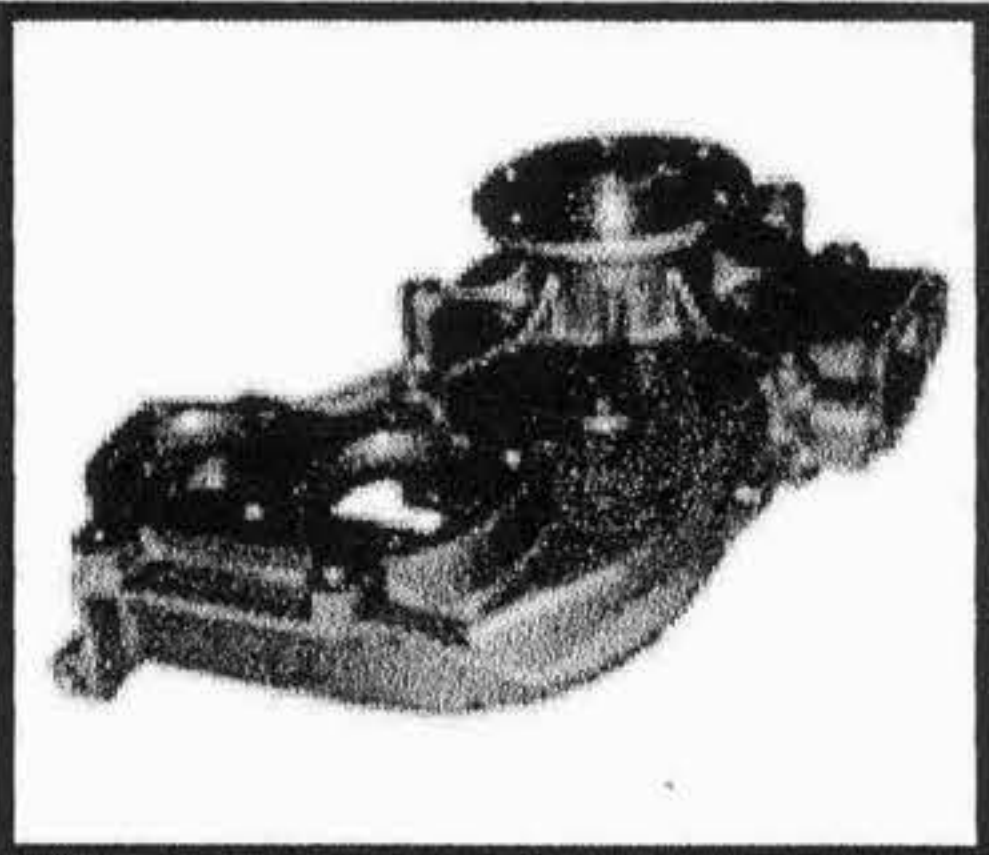
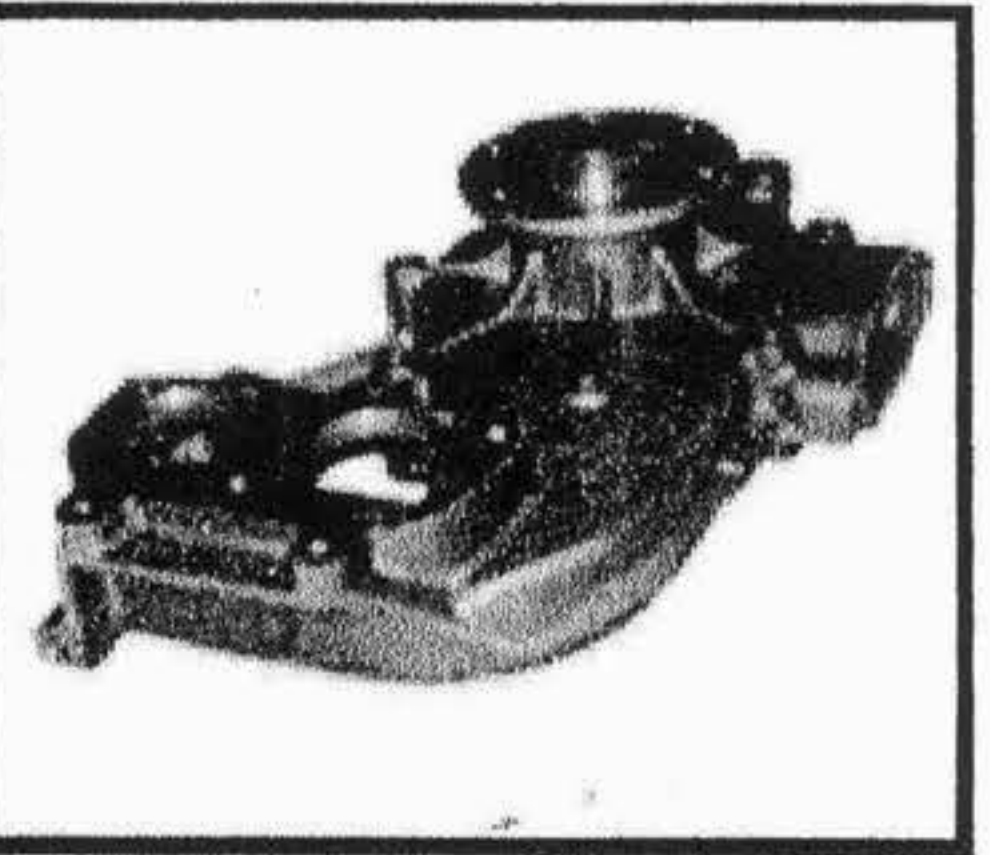
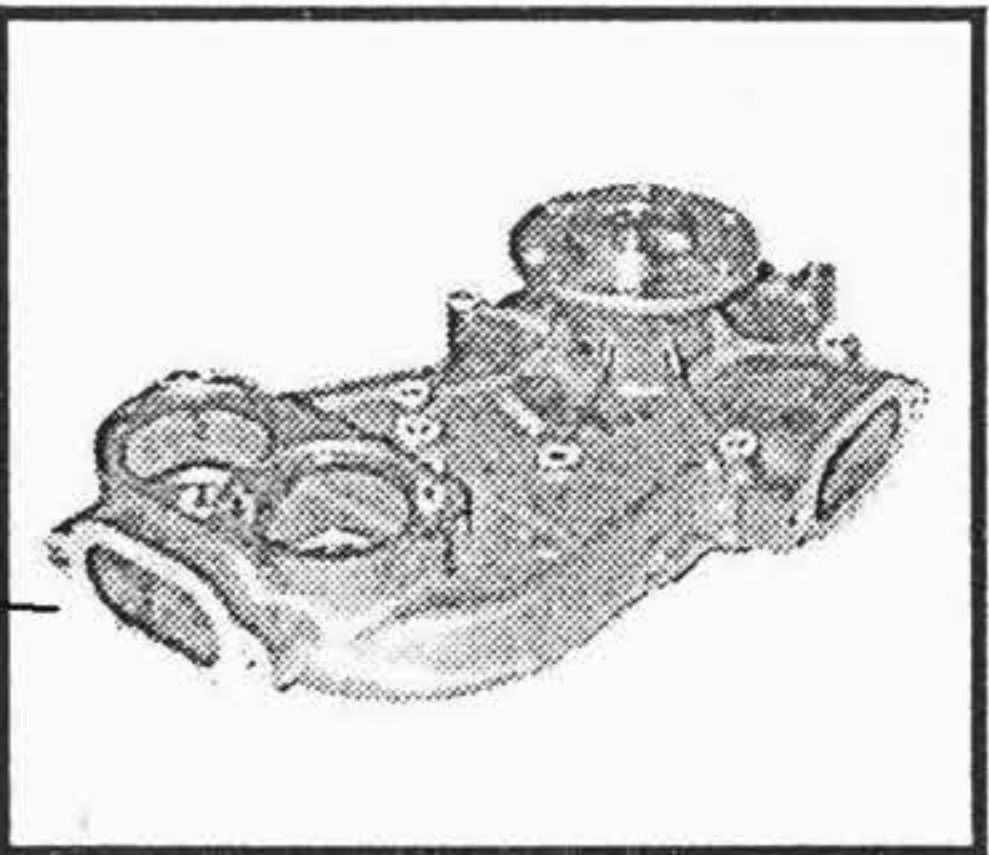
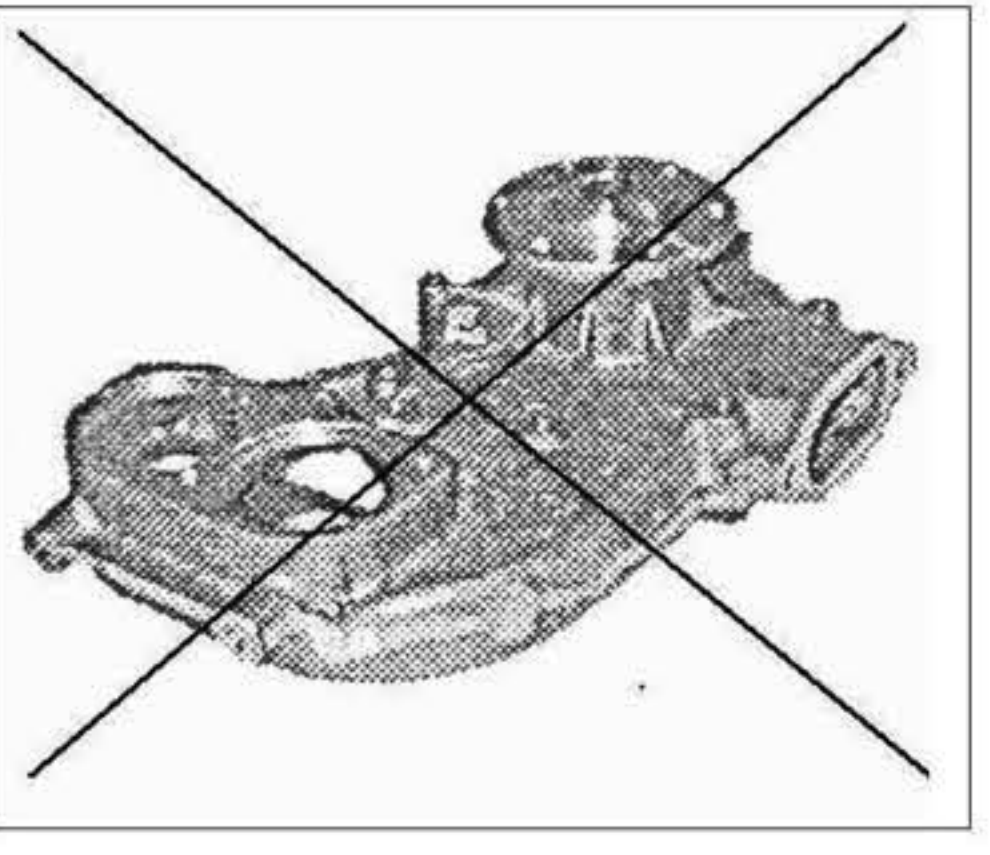
TYPE OR MODEL	ENGINE	WATER PUMP	REPAIR KIT
<p>tutte le versioni con motore all version with engine</p>	<p>OM 447 / LA OM 449 A / LA BRAZIL</p>	<p>241.865 475.200.01.01</p>  <p>note : girante / impeller Ø 135 mm</p>	<p>242.237 422.200.04.04</p> 
<p>VARIO 612 D - 812 D</p> <p>614 D - 714 D - 814 D</p> <p>WL - WM 711 - 811 - 814 817 - 917 - 1117 - 1317 - 1517</p> <p>ATEGO 815, 817, 1017, 1217 1223, 1523 OM 904 ENGINE</p>	<p>OM 904 LA ECOPOWER OM 904.908</p> <p>OM 904.906</p> <p>OM 904.905 / .906 OM 904.907</p> <p>OM 904 LA OM 906 LA</p>	<p>241.850 904.200.04.01</p>  <p>One Thermostat</p> <p>OM 904 LA</p>	<p>241.851 906.200.04.01</p>  <p>NEW</p> <p>Two Thermostats</p> <p>OM 906 LA - OPTARE SOLO MK11 CITARO - BUS</p>
<p>ACTROS 1831, 1835, 1840, 1843</p> <p>2643</p>	<p>OM 501 LA</p>	<p>241.855 542.200.19.01</p>  <p>135 mm Impeller OM 501</p>	<p>241.700 541.200.12.01</p>  <p>125 mm Impeller OM 501</p>
<p>ACTROS 1848, 1853, 1857</p> <p>Retarder Flange</p>	<p>OM 502 LA</p>	<p>241.860 542.200.06.01</p>  <p>OM502 + Retarder Flange</p>	<p>542.200.0501</p>  <p>Special Application Version of OM501</p>

MERCEDES BENZ



Tel: +(0)44 1925 850082 Fax: +(0)44 1925 850083
www.spwaterpumps.co.uk

TYPE OR MODEL	ENGINE	WATER PUMP	REPAIR KIT
MERCEDES ACTROS 11 GENERATION 1850, 1854, 1858 542.200.2101	OM502 LA V8, 15.9 Ltr	241.703 Actros 11 Generation	
MERCEDES ACTROS 11 GENERATION 542.200.2201 For Units - WITH RETARDER	OM502 LA V8, 15.9 Ltr	241.704 Retarder Flange Actros 11 Generation	
MERCEDES OM442 442.200.0701	OM442 OM457 HLA 6 Cyl Retarder Flange → 442.200.0701 Plugged Hole →	241.708 	241.705 No Retarder Flange 457.200.0801 OM 457HLA
MERCEDES 1938, 1944, 2638 AXOR 1835LS, 1840LS 1843LS, 2535LS 2450LS, 2543LS 0 505, Citaro G, Citaro U Connecto H, Integro Turismo 15 RHD Travedo, 15RH, 15RHD Travedo 17 RHF	OM457 LA OM457 HLA 17mm Hole 125mm Impeller Retarder Flange → 457.200.0501 17mm Hole →	241.710 	

MERCEDES



Tel: +(0)44 1925 850082 Fax: +(0)44 1925 850083
www.spwaterpumps.co.uk

TYPE OR MODEL	ENGINE	WATER PUMP	REPAIR KIT



SECTION 34/2

APPLICATION

PERKINS

**WATER PUMPS WASSERPUMPEN
POMPE A EAU BOMBA DE AGUA
POMPA ACQUA**

**S.P. WATER PUMPS LTD
18 Tatton Court, Kingsland Grange, Woolston,
Warrington, Cheshire. ENGLAND. WAI 4RR
TEL: +44(0) 1925 850082 Fax: +44(0) 1925 850083
Email:sales@spwaterpumps.co.uk Web Site:www.spwaterpumps.co.uk**

TAVOLE DI CONVERSIONE
 TABLE DE CONVERSION
 CONVERSION TABLE

PERKINS -



NUMERO ORIGINALE NUMERO ORIGINAL ORIGINAL NUMBER	NUMERO SOSTITUTIVO REPLACE PAR NUMERO REPLACED BY NUMBER	RIFERIMENTO OMP REFERENCE OMP OMP REFERENCE
32346		259.066
58293	89019	
59140	89024	
68355	U7LW0008	
68364	U7LW0062	
68573	U7LW0007	
68575	U7LW0015	
68584	U7LW0020	
85707	86948	252.154
85800	U7LW0025	
85805	U7LW0003	
86948	U7LW0055	
86951	U7LW0003	
86957	U7LW0029	
89001	U7LW0022	
89007	U7LW0024	
89009	U7LW0022	
89019	U7LW0044	
89024	U7LW0027	
89030	U7LW0003	
89032		
89034	U7LW0006	
89036	U7LW0009	
0030927		259.058
0040057		259.058
0080268	0170040	251.184
0170046		259.009
0380098		259.053
0380164		259.051
0490484		259.068
0490690		259.064
0500006		251.191
0524406		259.028
0576005		259.006
0576007		259.031
0650540		259.041
0670165		259.305
0748419		259.071
0920007		251.201
0920009		259.032
0920056		259.037
0920058		251.772
0920106		251.381
0994650	3600973M91	
0994658	41312038	
2232133		259.072
2415209	2415216	

NUMERO ORIGINALE NUMERO ORIGINAL ORIGINAL NUMBER	NUMERO SOSTITUTIVO REPLACE PAR NUMERO REPLACED BY NUMBER	RIFERIMENTO OMP REFERENCE OMP OMP REFERENCE
2415213		259.136
2415216		251.042
2417204		259.141
2417208		259.022
2431154		259.041
2564406		259.028
2418M001	2418M004	
2418M004		259.428
2418M006		
2418M007		159.428
2521D406		259.158
2721A530		251.354
31142691		259.335
31145630		259.035
31145713		259.315
31145741		259.085
31146362		259.135
31146952		259.015
31155232		259.205
32753417		259.056
32764119	3276P003	
32764124		259.078
32764127	3276P003	
3276P003		259.014
3312K011		259.156
3312K012		251.204
33143112		259.024
33143409		259.077
33157108		259.019
33157109		259.017
33157144		259.037
33415136		259.039
33811314		259.052
33813313		259.018
33814115		259.038
36866271		259.042
36866724	36866271	
36867108		259.101
36867137		259.087
37447192		259.061
37447603		259.076
37447632		259.084
37447680		259.143
37477232		259.059
37711262		259.063
37711301		259.129
37711321		259.089

OGNI RIFERIMENTO ORIGINALE E' ASSOLUTAMENTE INDICATIVO. CHAQUE REFERENCE ORIGINAL EST ABSOLUMENT INDICATIVE. EVERY ORIGINAL PART NUMBER HAS TO BE CONSIDERED FOR REFERENCE PURPOSE ONLY.

TAVOLE DI CONVERSIONE
TABLE DE CONVERSION
CONVERSION TABLE

PERKINS -



NUMERO ORIGINALE NUMERO ORIGINAL ORIGINAL NUMBER	NUMERO SOSTITUTIVO REPLACE PAR NUMERO REPLACED BY NUMBER	RIFERIMENTO OMP REFERENCE OMP OMP REFERENCE
37711530		259.067
37711632		259.016
37711892		259.381
37712330		259.201
37712390		
37712470		259.291
37712540	37712541	
37712541		259.221
37712630		259.134
3771F011		159.391
41312038	41312063	
41312054	41312055	
41312055	41312494	
41312059	41312159	
41312063	41312064	
41312064	41312067	
41312067	41312165	
41312143	41312201	
41312159	41312416	
41312165	41312167	
41312167	41312266	
41312201	41312219	
41312219	41312245	
41312245	41312246	
41312246	41312248	
41312248	41312251	
41312251	41312323	
41312266	41312506	
41312323	41312325	
41312325	41312348	
41312348	41312349	
41312349	41312351	
41312351	41312354	
41312354	41312356	
41312356	41312358	
41312358	41312366	
41312366	41312379	
41312379	41312551	
41312416	41312487	
41312419	VEDI U5MW0014	
41312459		259.370
41312486	VEDI U5MW0057	
41312487		259.080
41312491	VEDI U5MW0057	
41312493	VEDI U5MW0057	
41312494	41312517	
41312506	41312508	

NUMERO ORIGINALE NUMERO ORIGINAL ORIGINAL NUMBER	NUMERO SOSTITUTIVO REPLACE PAR NUMERO REPLACED BY NUMBER	RIFERIMENTO OMP REFERENCE OMP OMP REFERENCE
41312508	41312509	
41312511	41312574	
41312517	41312544	
41312518		259.110
41312521		259.070
41312524	VEDI U5MW0057	
41312527	VEDI U5MW0057	259.310
41312544	41312784	
41312549	41312557	
41312551	41312552	
41312552	41312554	
41312554	41312561	
41312557	41312558	
41312558	41312559	
41312559	41312654	
41312561	41312562	
41312562	41312564	
41312564	41312566	
41312566	41312568	
41312568	41312689	
41312574	= 41312892	259.040
41312584	VEDI U5MW0057	
41312589	VEDI U5MW0023	
41312591	VEDI U5MW0023	
41312595	VEDI U5MW0023	
41312596	VEDI U5MW0057	
41312654	41312682	
41312663	VEDI U5MW0014	
41312681	VEDI U5MW0016	
41312682	41312698	
41312689	41312756	
41312698	41312906	
41312723	VEDI U5MW0014	
41312747	VEDI U5MW0014	
41312756	41312908	
41312768	VEDI U5MW0023	
41312783	VEDI U5MW0023	
41312784		259.050
41312785	VEDI U5MW0023	
41312786	VEDI U5MW0023	
41312806	VEDI U5MW0016	
41312807	VEDI U5MW0016	
41312808	VEDI U5MW0016	
41312809	VEDI U5MW0016	
41312811	VEDI U5MW0037	
41312828	VEDI U5MW0014	
41312892	= 41312574	

OGNI RIFERIMENTO ORIGINALE E' ASSOLUTAMENTE INDICATIVO. CHAQUE REFERENCE ORIGINAL EST ABSOLUMENT INDICATIVE. EVERY ORIGINAL PART NUMBER HAS TO BE CONSIDERED FOR REFERENCE PURPOSE ONLY.

TAVOLE DI CONVERSIONE
TABLE DE CONVERSION
CONVERSION TABLE

PERKINS -



NUMERO ORIGINALE NUMERO ORIGINAL ORIGINAL NUMBER	NUMERO SOSTITUTIVO REPLACE PAR NUMERO REPLACED BY NUMBER	RIFERIMENTO OMP REFERENCE OMP OMP REFERENCE
41312906	41312907	
41312907	41313018	
41312911	41312913	
41312913	41312915	
41312915	41312918	
41312918	41313201	
41313018	41313045	
41313027		159.355
41313033	41313047	
41313038	= 41313086	159.070
41313045		159.090
41313047	= 41313049	159.260
41313058	= 41313027	
41313065	= 41313047	
41313068	= 41313045	
41313075	= U5MW0016	
41313085	= U5MW0019	
41313086	= 41313038	
41313201	41313225	
41313209	41313218	
41313211	41313226	
41313212	41313228	259.380
41313218	41313227	159.150
41313225	41313231	
41313226	41313233	
41313227	41313237	
41313228		159.380
41313231	4131A013	159.450
41313232	4131A021	159.460
41313233		159.350
41313237		159.470
41313256	= 41313226	
41313261	= 41313237	
41313269	= U5MW0014	
41313402	= U5MW0057	
41313403	= U5MW0023	
41313801	41313812	
41313812		
4131A013	4131A021	
4131A021	4131A029	
4131A029	4131A034	
4131A034		159.490
4131E002	4131E005	
4131E005	4131E007	
4131E007	4131E011	
4131E011		159.500
4131E012		159.510

NUMERO ORIGINALE NUMERO ORIGINAL ORIGINAL NUMBER	NUMERO SOSTITUTIVO REPLACE PAR NUMERO REPLACED BY NUMBER	RIFERIMENTO OMP REFERENCE OMP OMP REFERENCE
U5MW0006	U5MW0057	
U5MW0010	U5MW0055	
U5MW0014		159.140
U5MW0016		159.230
U5MW0019		159.110
U5MW0023		159.310
U5MW0037		
U5MW0041	U5MW0054	
U5MW0044		159.360
U5MW0054		159.370
U5MW0055	U5MW0061	
U5MW0056	U5MW0062	
U5MW0057		159.375
U5MW0061		159.365
U5MW0062		159.475
U5MW0088	= U5MW0062	
U5MW0089	= U5MW0061	
U5MW0092	= 4131E011	
U5MW0096	= U5MW0057	
U5MW0097	= U5MW0023	
U5MW0104	= 4131A034	
U5MW0106	= 41313228	
U5MW0108	= 41313237	
U5MW0111	= 41313045	
U5MW0133	= 41313027	
U5MW0144	= 41313027	
U5MW0147	= U5MW0014	
U7 LW0002	U7 LW0030	
U7 LW0003		252.175
U7 LW0006	U7 LW0029	
U7 LW0007	U7 LW0002	
U7 LW0008	U7 LW0031	
U7 LW0009		152.097
U7 LW0015		152.153
U7 LW0020		252.243
U7 LW0022		152.156
U7 LW0024		252.136
U7 LW0025		152.112
U7 LW0027		152.107
U7 LW0029	U7LW0032	
U7 LW0030		152.255
U7L W0031		152.256
U7 LW0032	U7L W0058	
U7 LW0034	U7 LW0071	
U7 LW0044		152.130
U7 LW0047		152.259
U7 LW0055		152.155

OGNI RIFERIMENTO ORIGINALE E' ASSOLUTAMENTE INDICATIVO. CHAQUE REFERENCE ORIGINAL EST ABSOLUMENT INDICATIVE. EVERY ORIGINAL PART NUMBER HAS TO BE CONSIDERED FOR REFERENCE PURPOSE ONLY.

SUITABLE





PERKINS

ENGINES

Tel: +44(0)1925 850082 Fax: +(0)44 1925 850083

www.spwaterpumps.co.uk

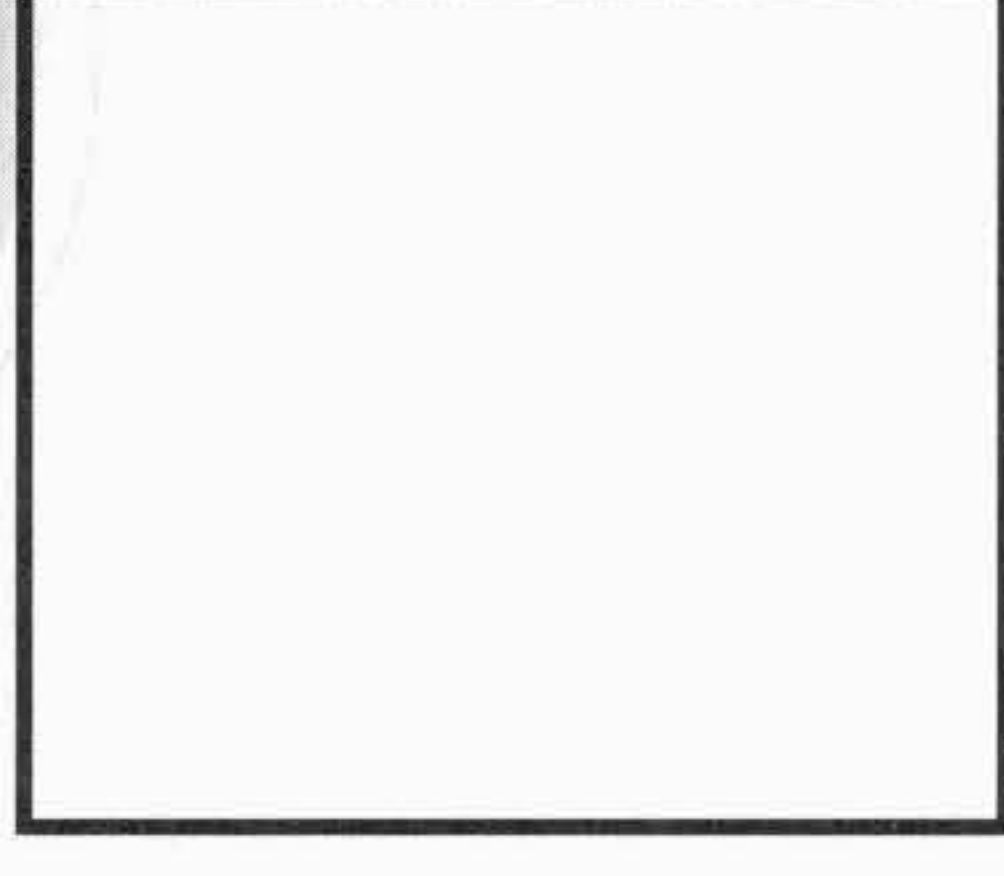

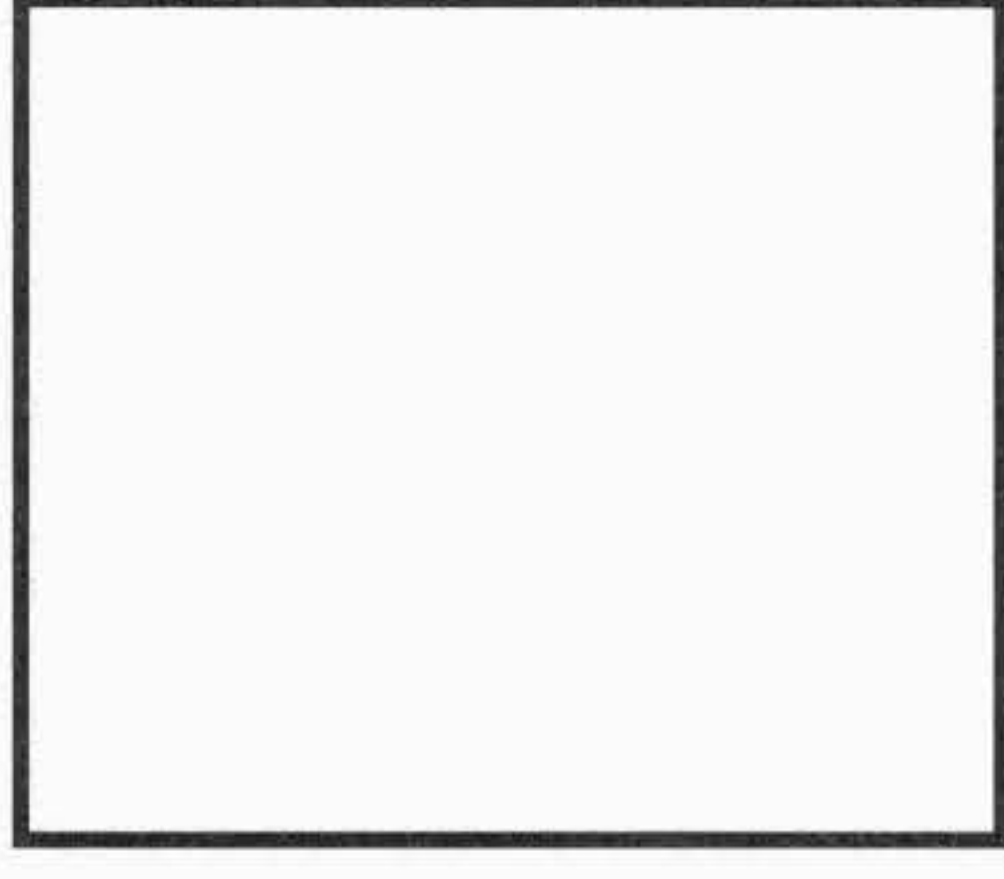
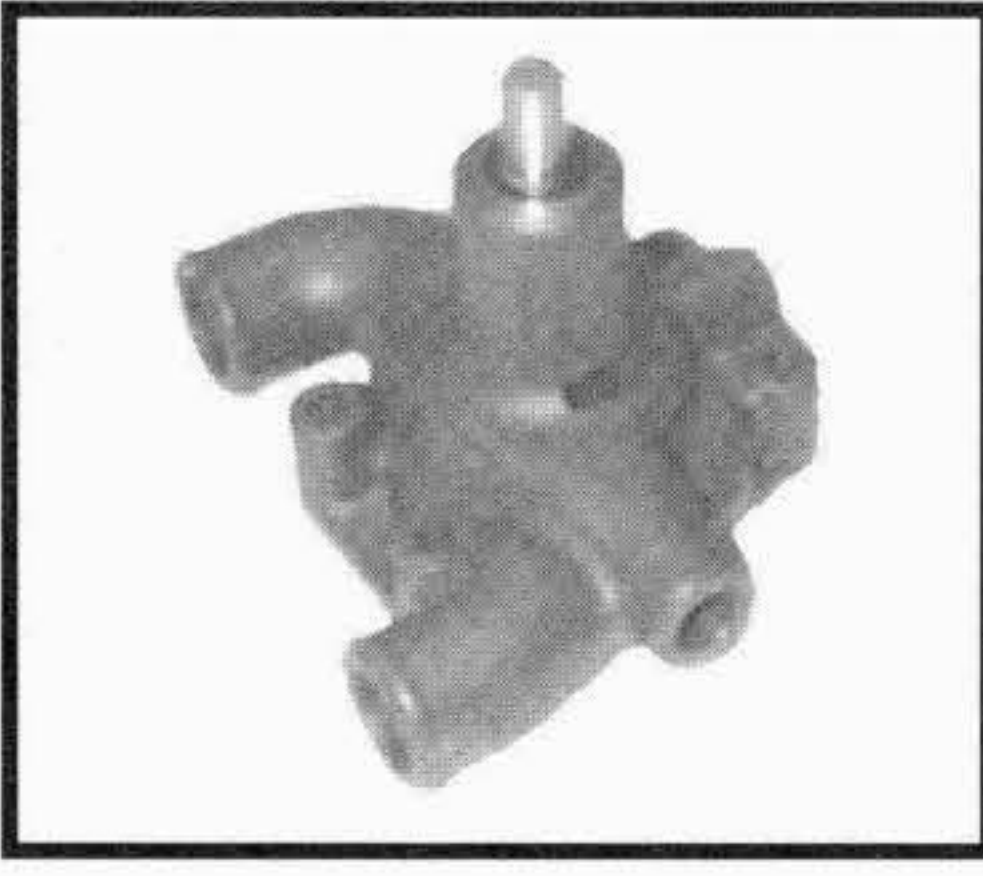
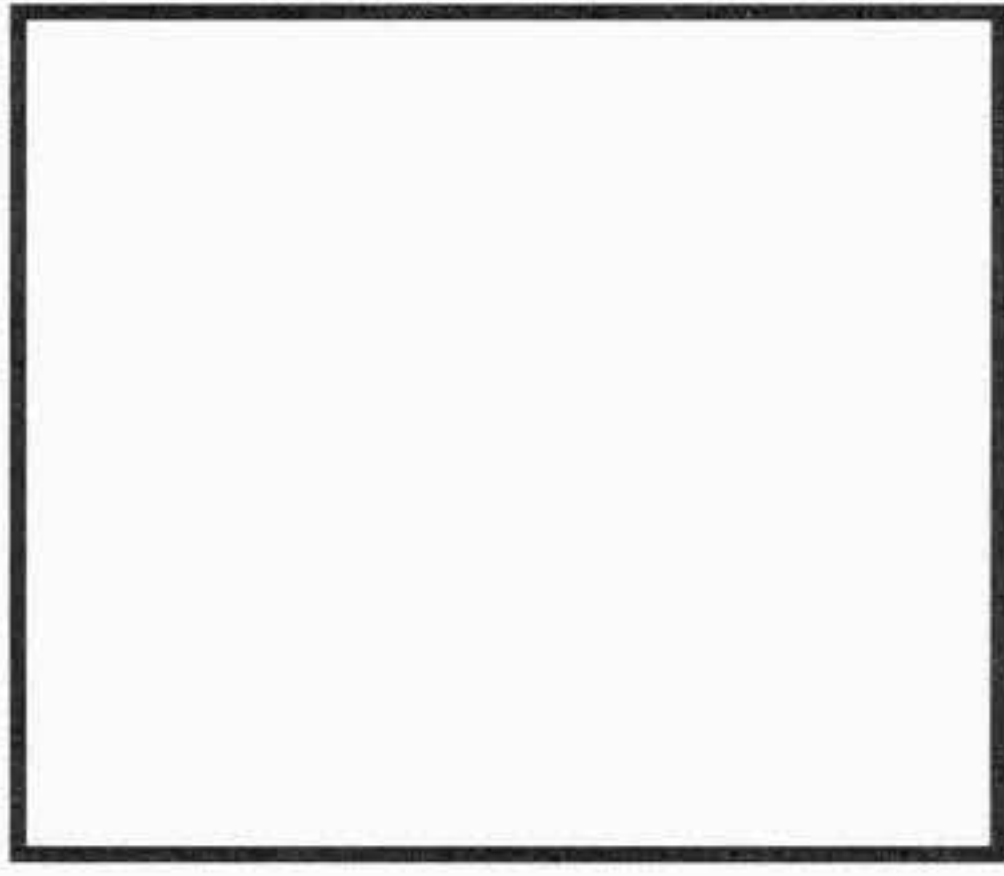
TIPO O MODELLO TYPE OU MODELE TYPE OR MODEL	MOTORE MOTEUR ENGINE	POMPA ACQUA POMPE A EAU WATER PUMP	KIT RIPARAZIONE NECESSAIRE DE REP. REPAIR KIT
	D2.101 P2 P3.144 3.152 AD3.152 D3.152 D3.152M F3.152 T3.152.4	<p>159.375 U5MW0057 SENZA PULEGGIA / WITHOUT PULLEY</p>  <p>--- 41312493 CON PULEGGIA / WITH PULLEY</p>	<p>152.130 U7LW0044</p> 
	AP3.144 A3.152 AD3.152 D3.152 T3.152.4	<p>259.080 41312487 CON PULEGGIA / WITH PULLEY</p>  <p>159.310 U5MW0023 SENZA PULEGGIA / WITHOUT PULLEY</p>	<p>152.130 U7LW0044</p> 
	D3.152 3.152 A3.152 AD3.152	<p>259.050 41312784 CON PULEGGIA / WITH PULLEY</p>  <p>159.310 U5MW0023 SENZA PULEGGIA / WITHOUT PULLEY</p>	<p>152.130 U7LW0044</p> 
	AP3.144 A3.152 D3.152 AD3.152 T3.152.4	<p>159.310 U5MW0023 SENZA PULEGGIA / WITHOUT PULLEY</p>  <p>--- 41312536 CON PULEGGIA / WITH PULLEY</p>	<p>152.130 U7LW0044</p> 

I ricambi non sono originali ma adattabili . Ogni riferimento originale é assolutamente indicativo .
Spare parts are not original but perfectly suitable . Every original part number has to be considered for reference purpose only .

SUITABLE





PERKINS

ENGINES

Tel: +44(0)1925 850082 Fax: +(0)44 1925 850083

www.spwaterpumps.co.uk

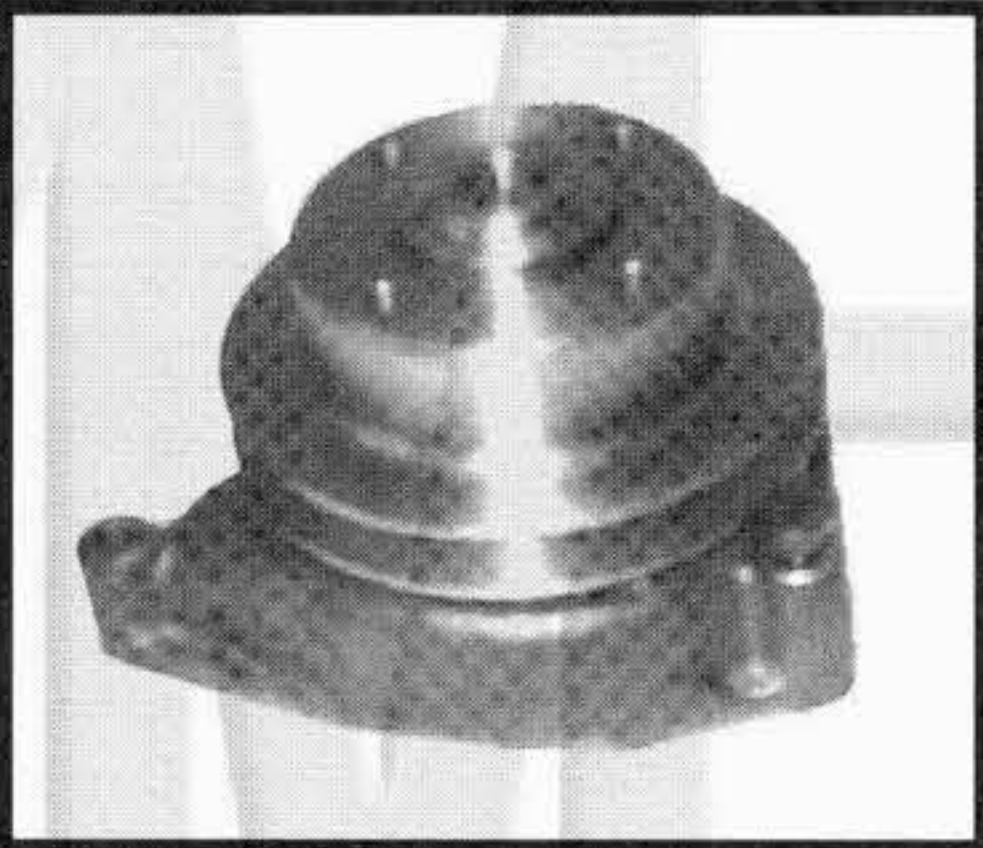
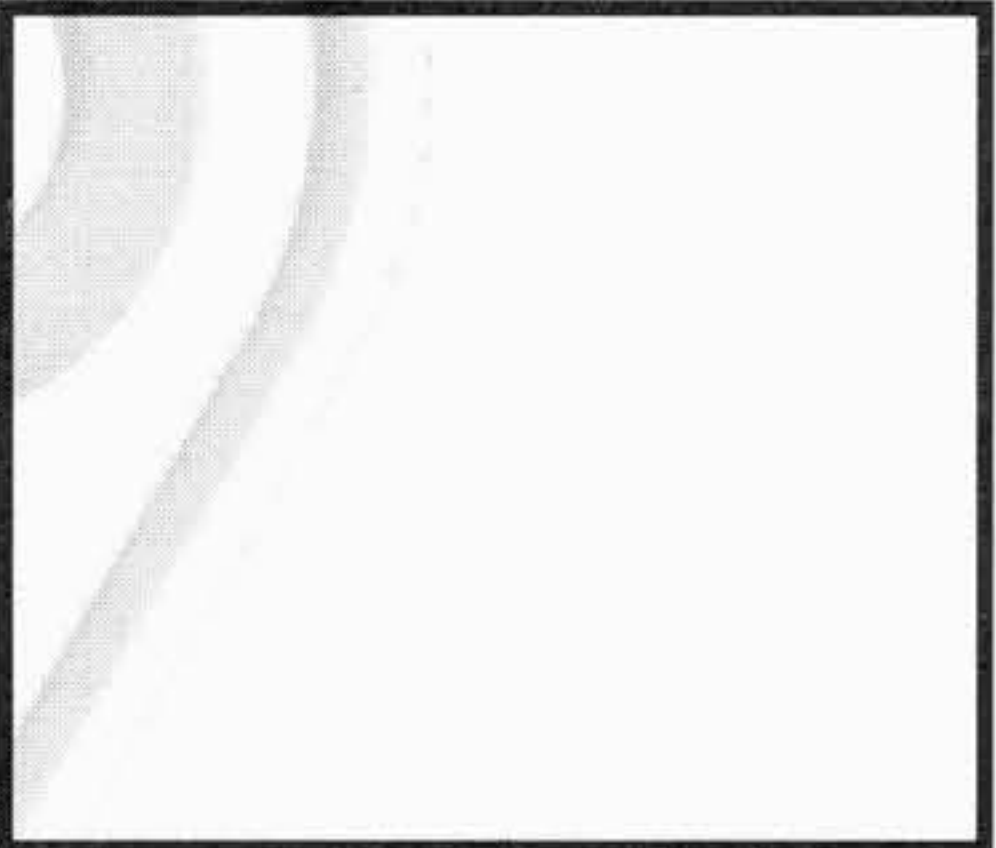
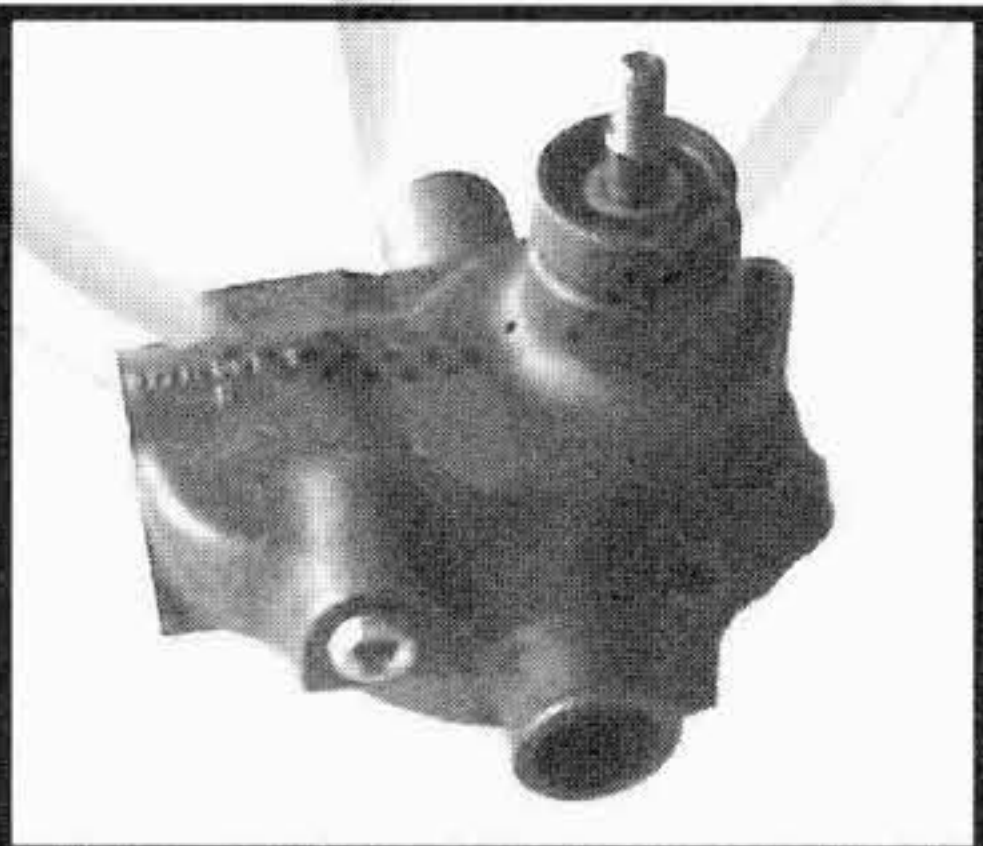

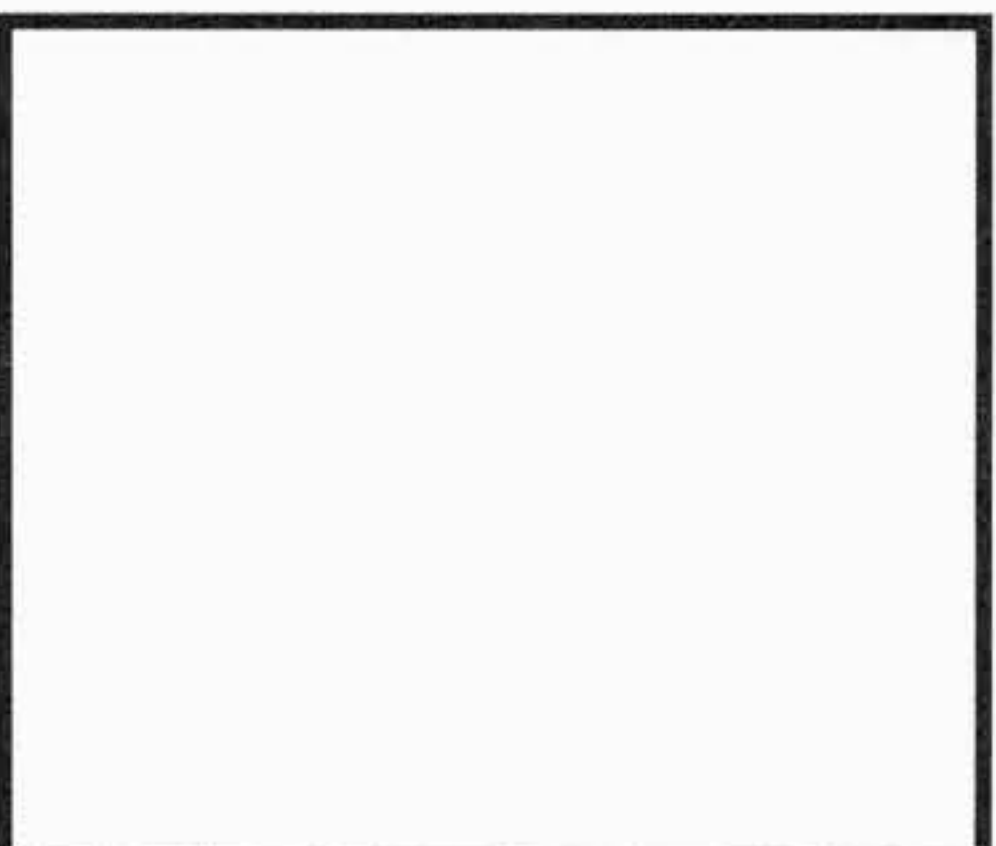
TIPO O MODELLO TYPE OU MODELE TYPE OR MODEL	MOTORE MOTEUR ENGINE	POMPA ACQUA POMPE A EAU WATER PUMP OMP REF. / O.EM. REF	KIT RIPARAZIONE NECESSAIRE DE REP. REPAIR KIT OMP REF. / O.EM. REF
	3.152.2 3.152.4 A3.152 D3.152 AD3.152	<p>159.310 U5MW0023 SENZA PULEGGIA / WITHOUT PULLEY</p> 	<p>152.130 U7LW0044</p> 
	4.107 4.108 4.108 M 4.108 O	<p>259.370 41312459 CON PULEGGIA / WITH PULLEY</p>  <p>159.370 U5MW0054 SENZA PULEGGIA / WITHOUT PULLEY</p>	<p>252.175 U7LW0003</p> 
	4.192 4.203	<p>--- 4131A005 SENZA PULEGGIA / WITHOUT PULLEY</p> 	<p>--- ---</p> 
	A4.192 D4.203 AD4.203	<p>259.040 41312574 CON PULEGGIA / WITH PULLEY</p>  <p>159.365 U5MW0061 SENZA PULEGGIA / WITHOUT PULLEY</p>	<p>152.107 U7LW0027</p> 

I ricambi non sono originali ma adattabili . Ogni riferimento originale é assolutamente indicativo .
Spare parts are not original but perfectly suitable . Every original part number has to be considered for reference purpose only .

SUITABLE

PERKINS

ENGINES

Tel: +44(0)1925 850082 Fax: +(0)44 1925 850083

www.spwaterpumps.co.uk

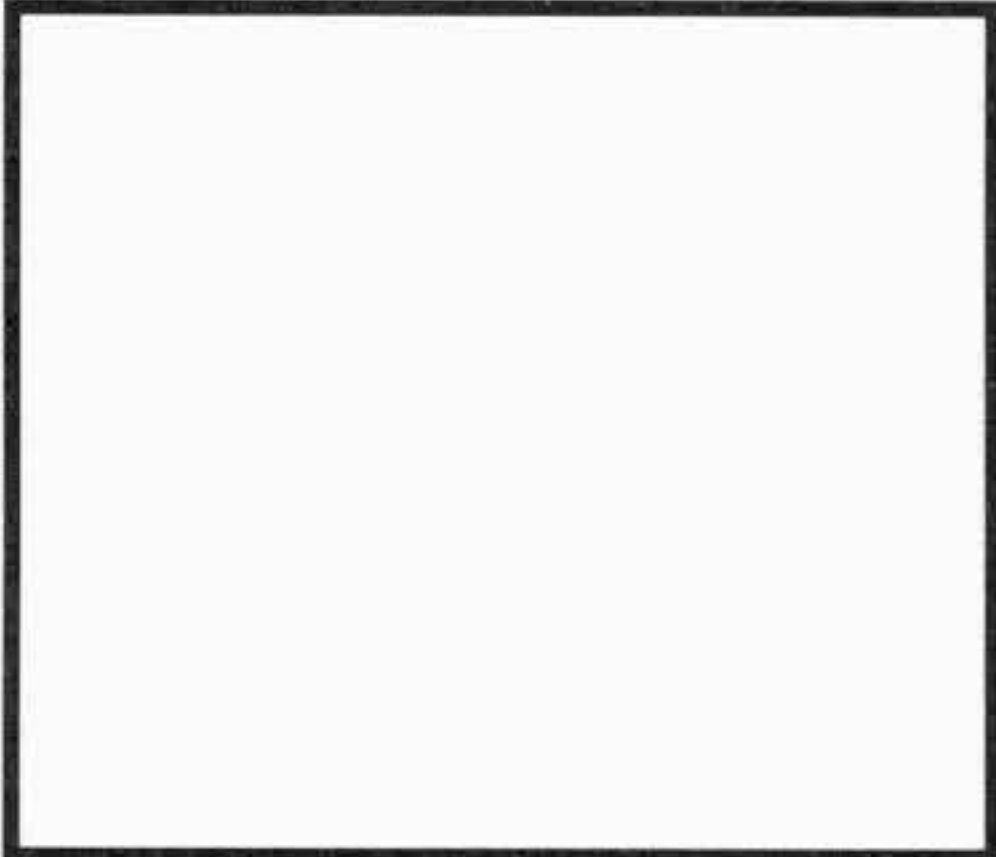
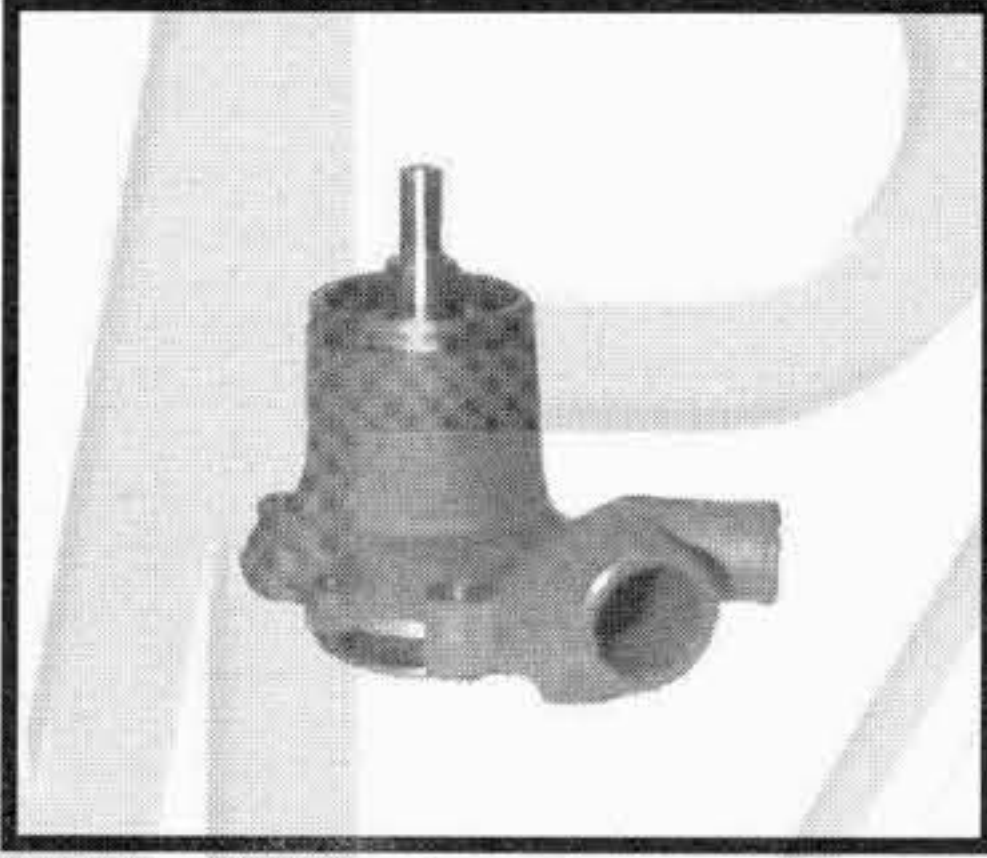
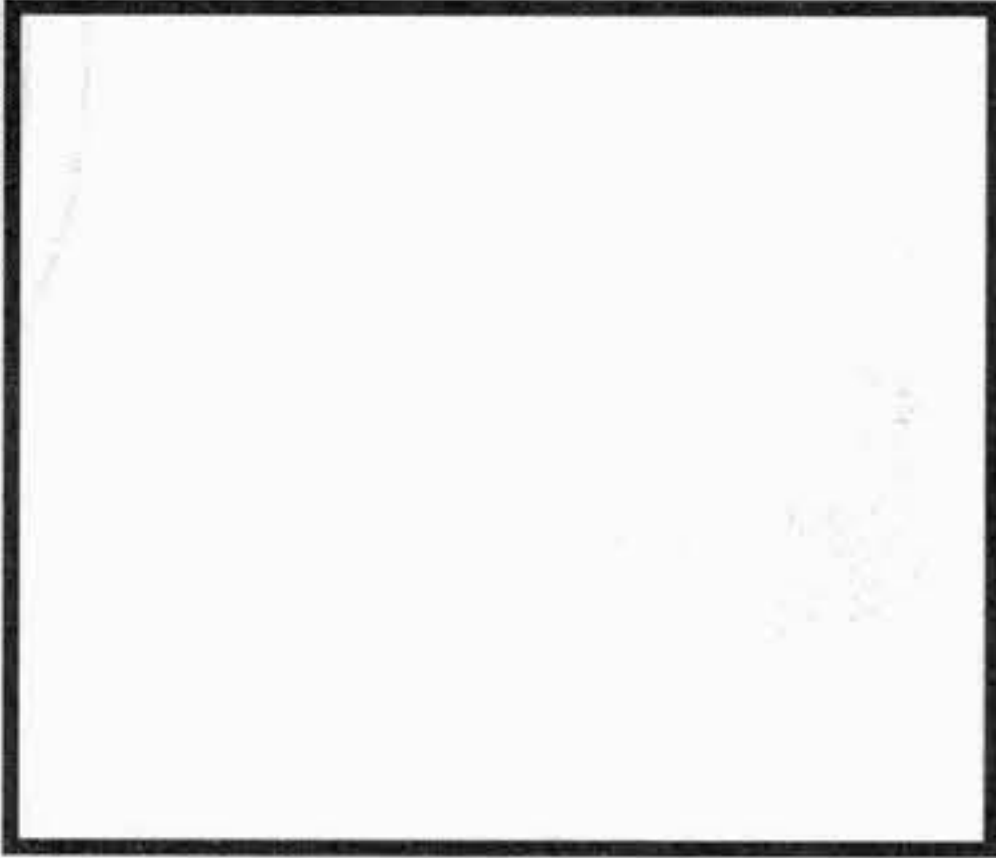
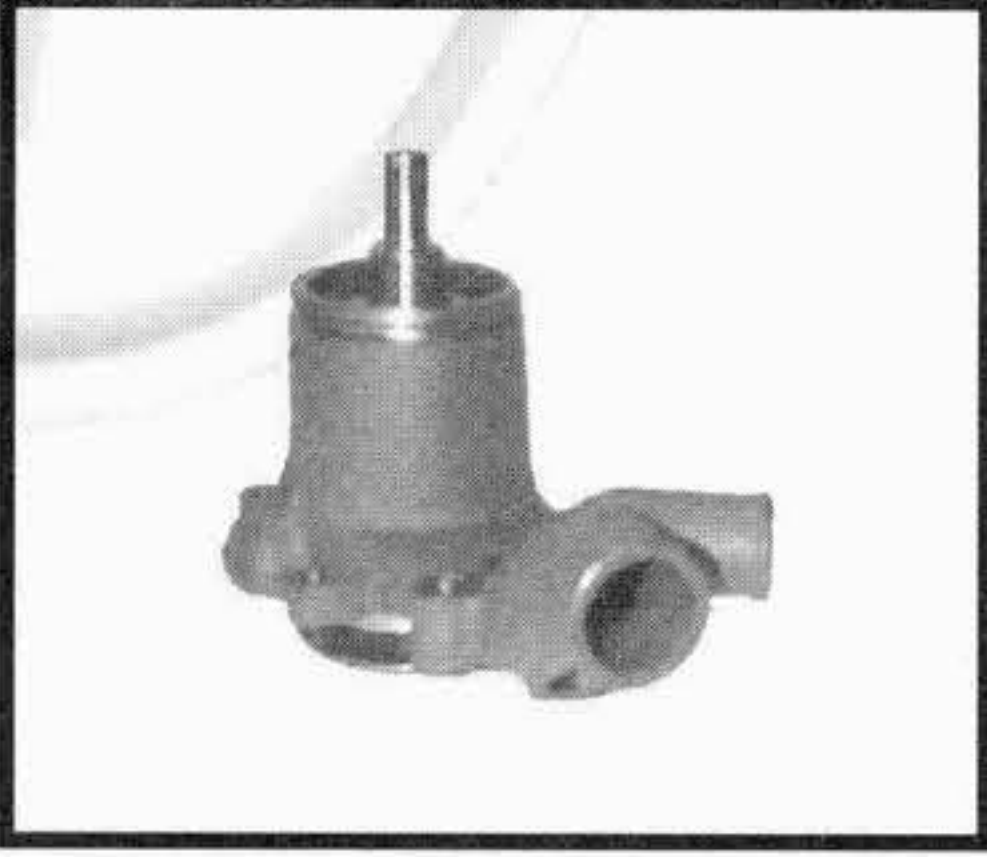
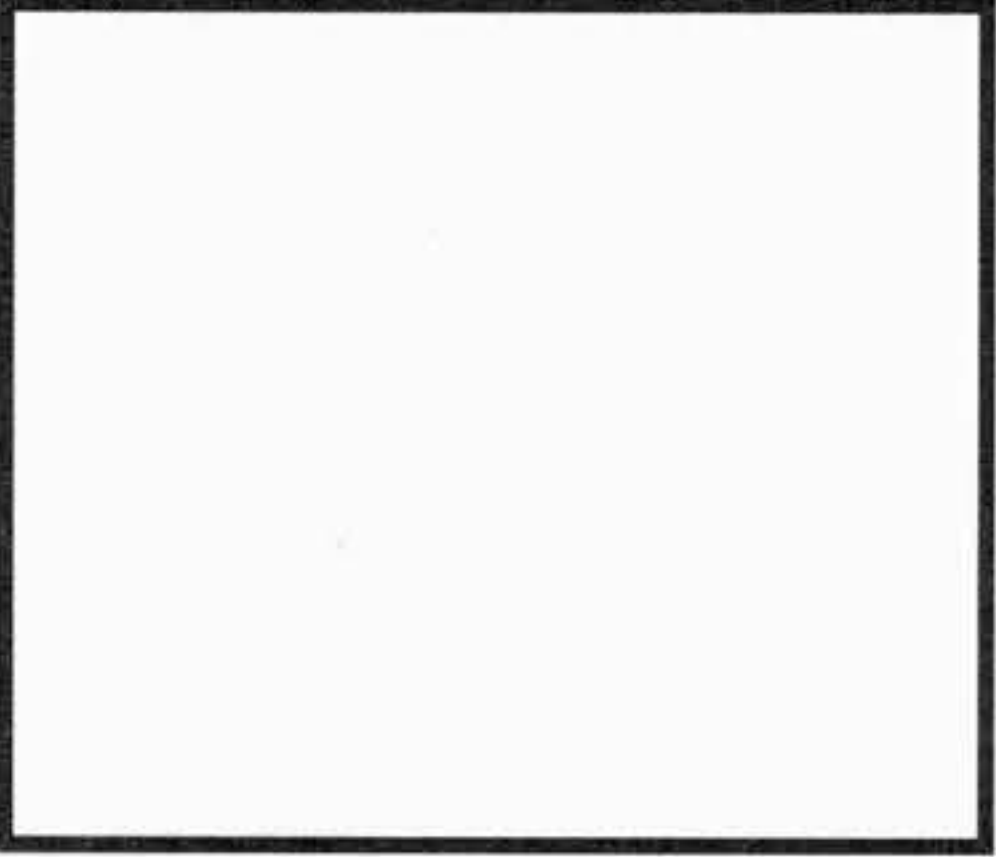
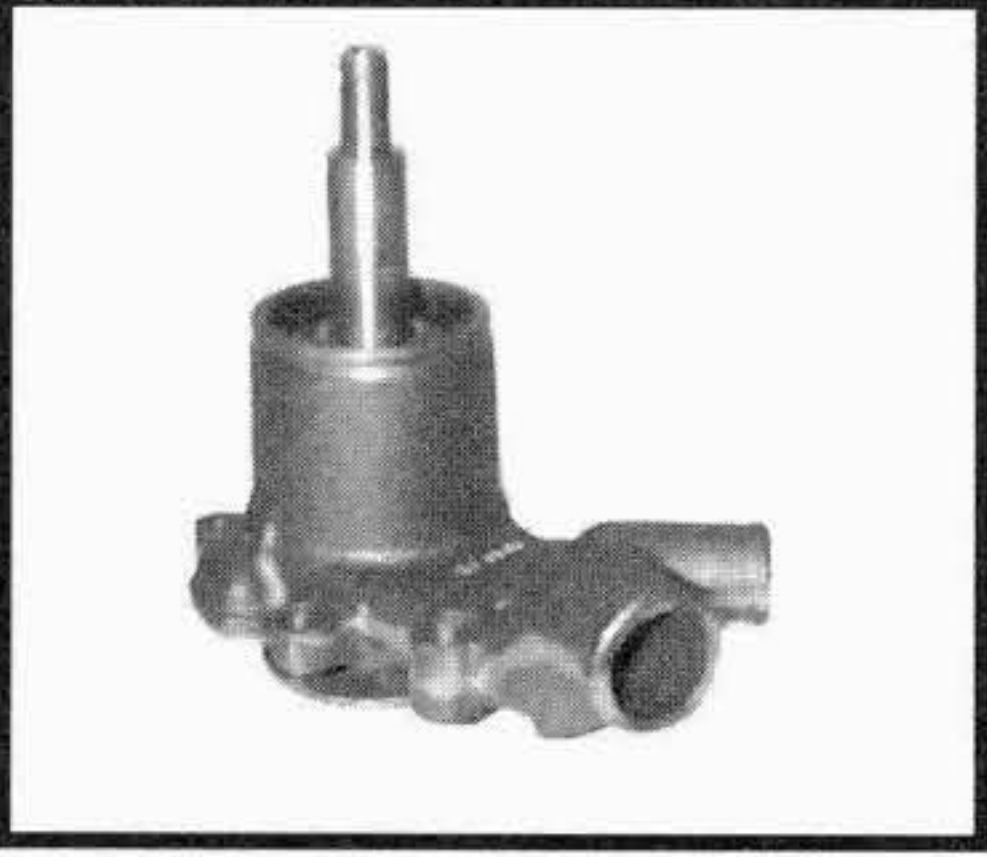
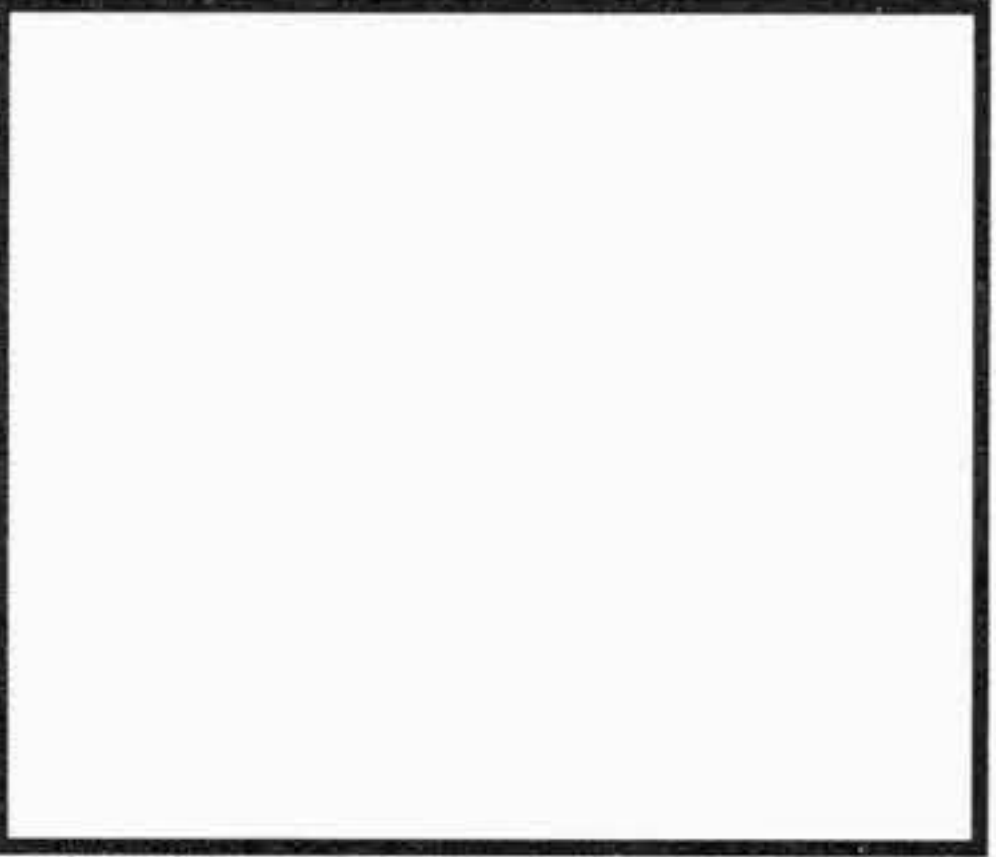

TIPO O MODELLO TYPE OU MODELE TYPE OR MODEL	MOTORE MOTEUR ENGINE	POMPA ACQUA POMPE A EAU WATER PUMP OMP REF. / O.EM. REF	KIT RIPARAZIONE NECESSAIRE DE REP. REPAIR KIT OMP REF. / O.EM. REF
	4.192 4.203 4.203.2 D4.203	159.475 U5MW0062 SENZA PULEGGIA / WITHOUT PULLEY 	152.259 U7LW0047 
	T4.236 4.248 A4.248	159.150 41313218 SENZA PULEGGIA / WITHOUT PULLEY  ad esaurimento sost. da / will be supersided by 159.470 41313237	152.255 U7LW0059 
	4.248 A4.248 T4.236	159.470 41313237 SENZA PULEGGIA / WITHOUT PULLEY  ALBERO / SHAFT L = 159 MM	152.255 U7LW0059 
	A4.248	159.350 41313233 SENZA PULEGGIA / WITHOUT PULLEY  ALBERO / SHAFT L = 198,65 MM	152.256 U7LW0031 

I ricambi non sono originali ma adattabili . Ogni riferimento originale é assolutamente indicativo .
Spare parts are not original but perfectly suitable . Every original part number has to be considered for reference purpose only .

SUITABLE









PERKINS

ENGINES

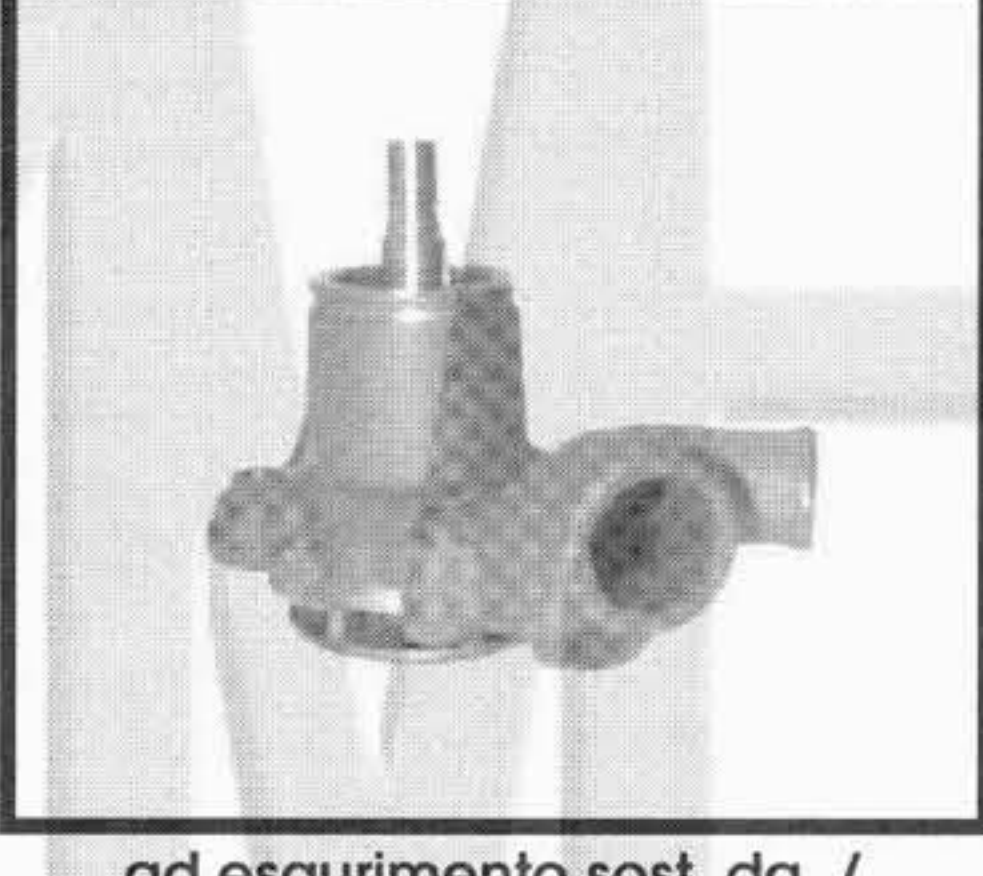
Tel: +44(0)1925 850082 Fax: +(0)44 1925 850083

www.spwaterpumps.co.uk

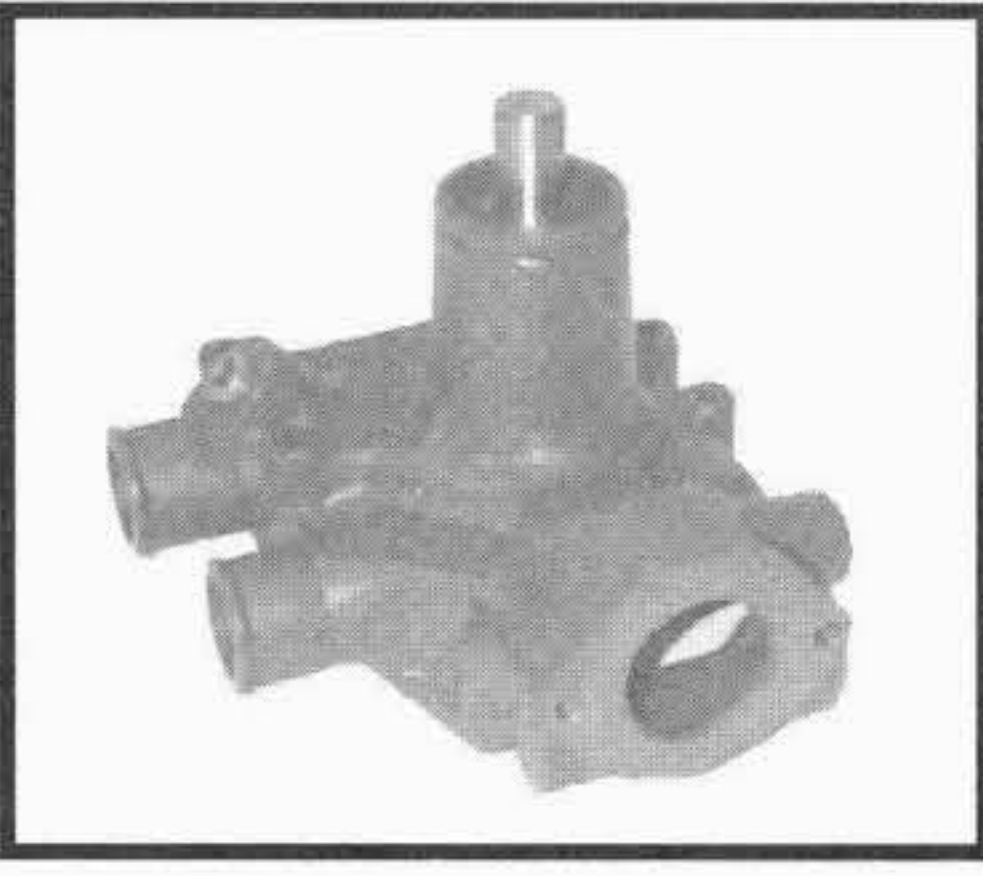

TIPO O MODELLO TYPE OU MODELE TYPE OR MODEL	MOTORE MOTEUR ENGINE	POMPA ACQUA POMPE A EAU WATER PUMP	KIT RIPARAZIONE NECESSAIRE DE REP. REPAIR KIT
	A4.212 4.236 4.236M 4.236.0 A4.236 4.248 4.248.2 A4.248	<p>259.450 41313231P CON PULEGGIA / WITH PULLEY</p>  <p>159.490 4131A034 SENZA PULEGGIA / WITHOUT PULLEY</p>	<p>152.183 U7LW0058 ALBERO / SHAFT Ø= 5/8 - 18 FIL. X 1"</p>  <p>152.112 U7LW0025 ALBERO / SHAFT Ø= 1/2 - 20 FIL. X 1"</p>
	T4.236 4.248	<p>259.380 41313212 SENZA PULEGGIA / WITHOUT PULLEY</p>  <p>ad esaurimento sost. da / will be supersided by 159.380 41313228</p>	<p>152.183 U7LW0058</p> 
	T4.236 4.248	<p>159.380 41313228 SENZA PULEGGIA / WITHOUT PULLEY</p> 	<p>152.183 U7LW0058</p> 
	A4.300 4.318	<p>159.140 U5MW0014 SENZA PULEGGIA / WITHOUT PULLEY</p>  <p>--- 41312419 CON PULEGGIA / WITH PULLEY</p>	<p>152.155 U7LW0055</p> 

I ricambi non sono originali ma adattabili . Ogni riferimento originale é assolutamente indicativo .
 Spare parts are not original but perfectly suitable . Every original part number has to be considered for reference purpose only .

SUITABLE





PERKINS

ENGINES

Tel: +44(0)1925 850082 Fax: +44(0)1925 850083

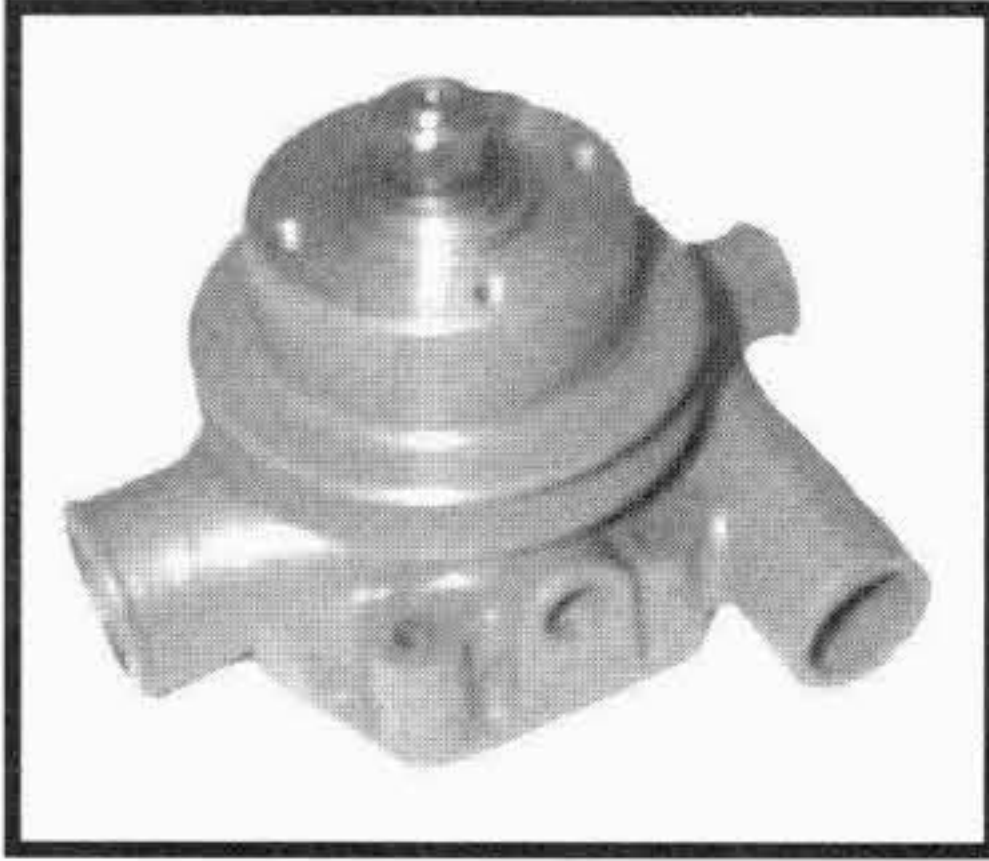
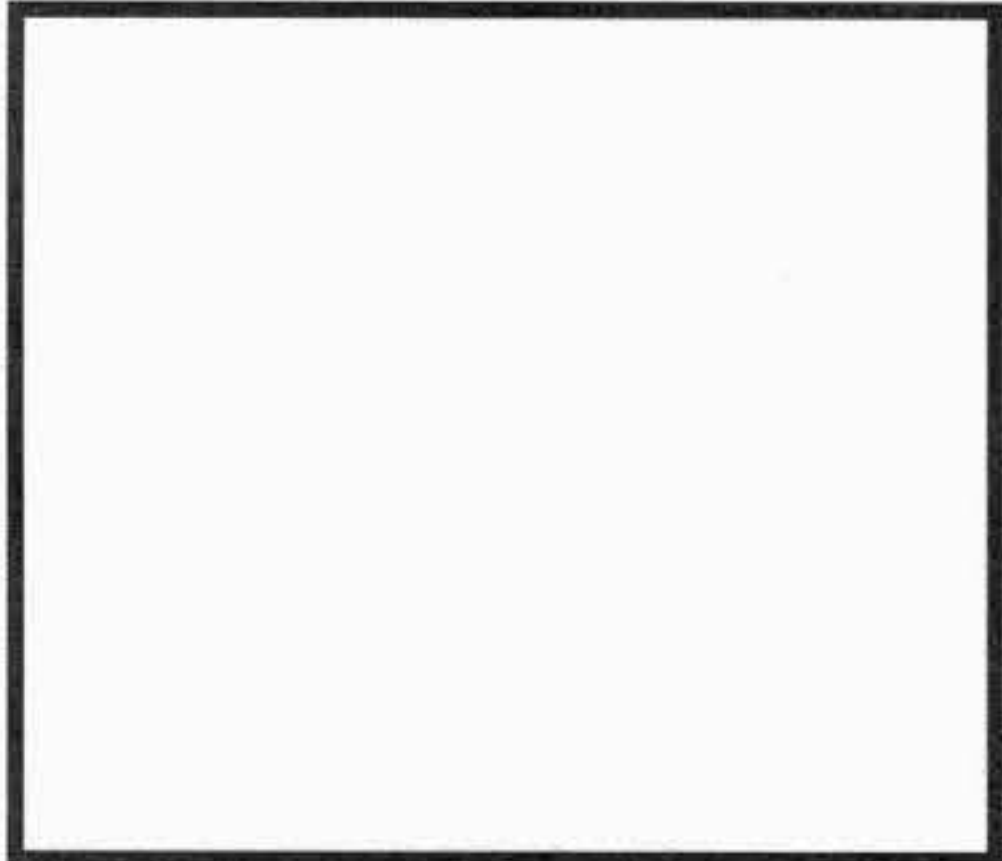
www.spwaterpumps.co.uk

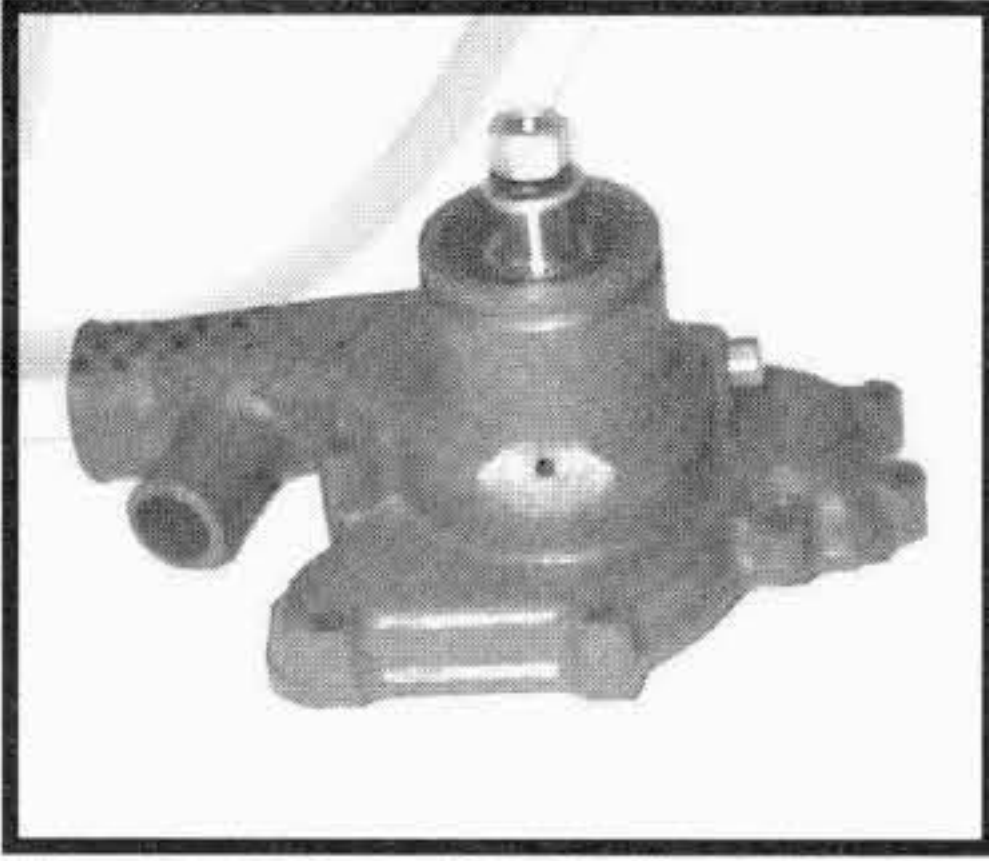

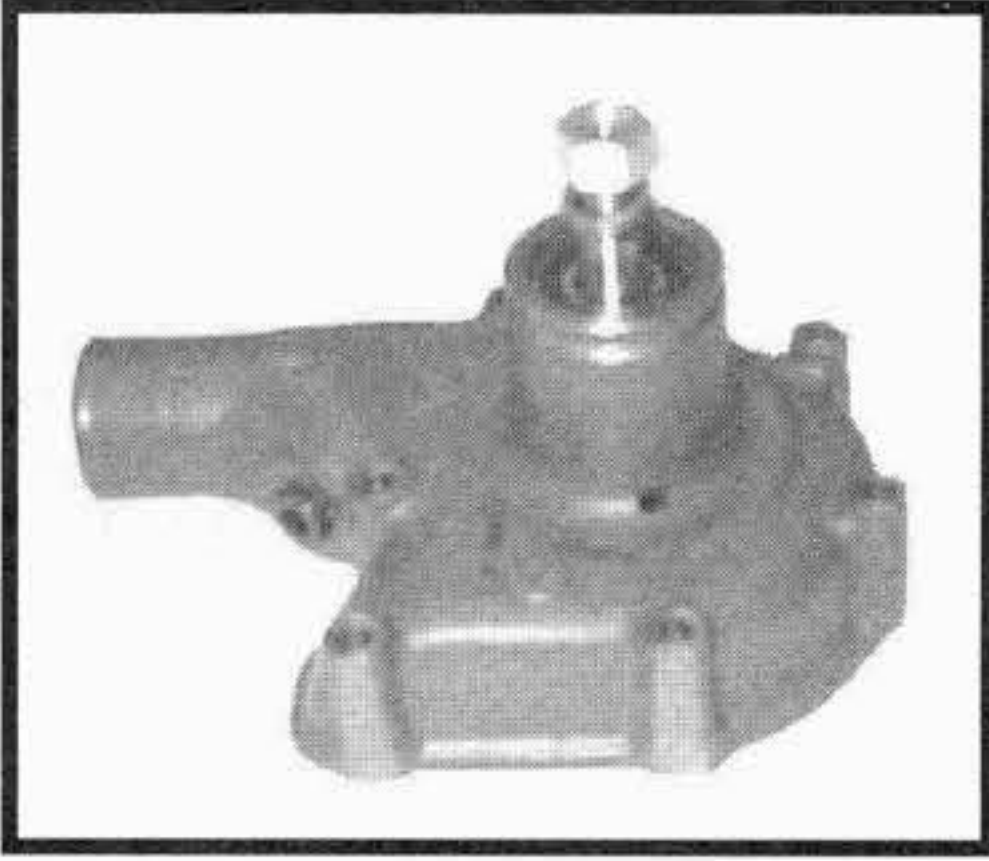
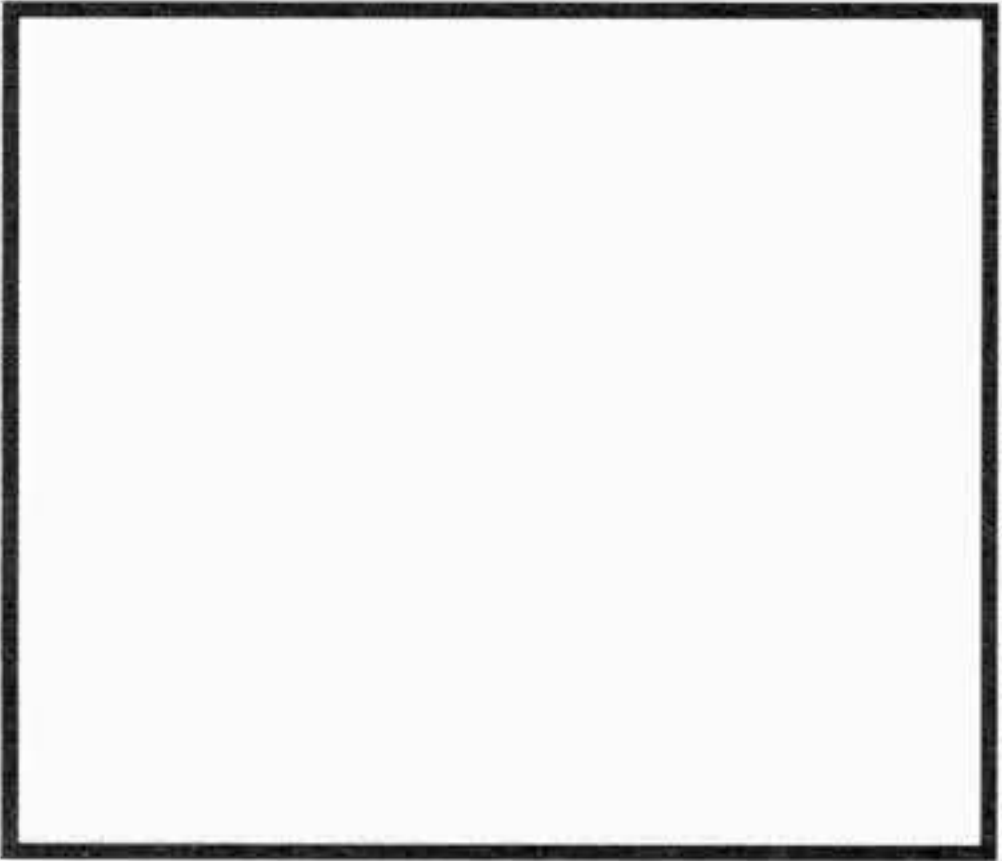
TIPO O MODELLO TYPE OU MODELE TYPE OR MODEL	MOTORE MOTEUR ENGINE	POMPA ACQUA POMPE A EAU WATER PUMP OMP REF. / O.EM. REF	KIT RIPARAZIONE NECESSAIRE DE REP. REPAIR KIT OMP REF. / O.EM. REF
	6.288	259.110 41312518 CON PULEGGIA / WITH PULLEY	152.152 58307
	6.305	 159.110 U5MW0019 SENZA PULEGGIA / WITHOUT PULLEY	
	6.354	159.090 41313045 SENZA PULEGGIA / WITHOUT PULLEY	152.097 U7LW0009
	6.354M		
	6.354.0		
	A6.354		
	T6.354		
	T6.354M		
	T6.354.0		
	6.354.4	159.260 41313047 SENZA PULEGGIA / WITHOUT PULLEY	252.243 U7LW0020
	A6.354.4		
	T6.354.4		
	6.372.4		
	A6.372.4		
	6.354.2	159.070 41313038 SENZA PULEGGIA / WITHOUT PULLEY	152.097 U7LW0009
	AT6.354		
	T6.354.1		
	6.372		
	6.372.1		
	A6.372		

I ricambi non sono originali ma adattabili . Ogni riferimento originale é assolutamente indicativo .

Spare parts are not original but perfectly suitable . Every original part number has to be considered for reference purpose only .

SUITABLE





PERKINS

ENGINES

Tel: +44(0)1925 850082 Fax: +(0)44 1925 850083

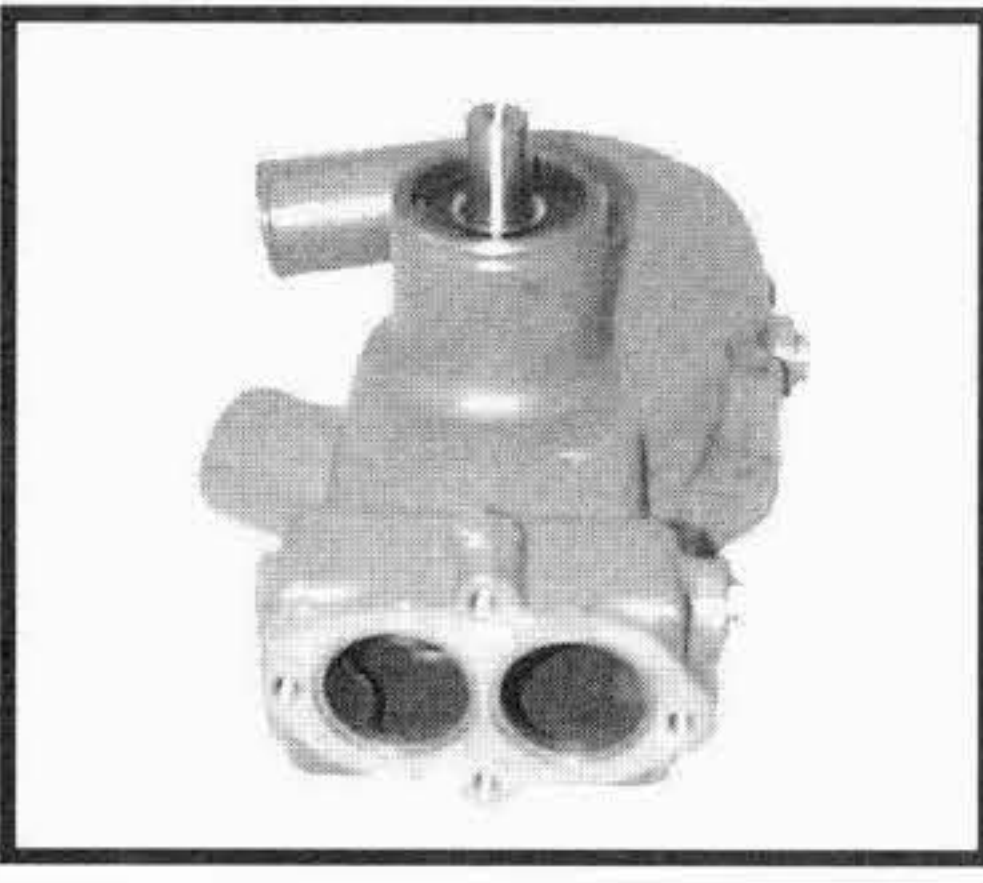
www.spwaterpumps.co.uk

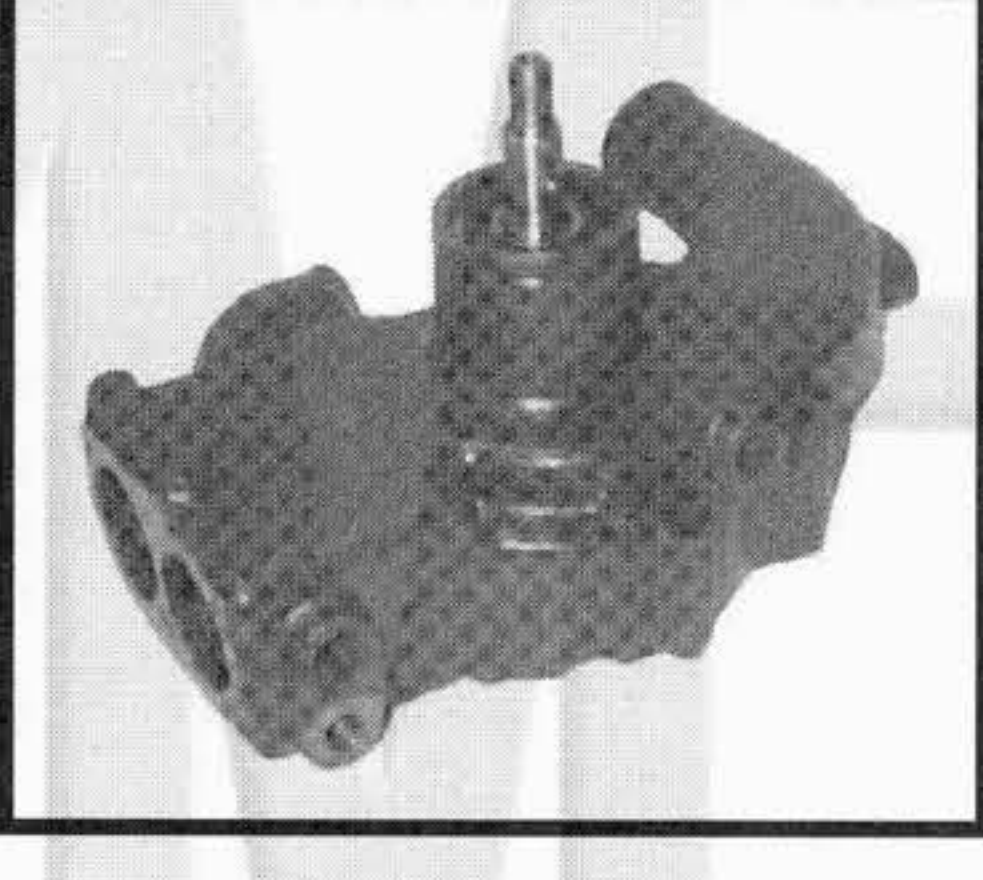

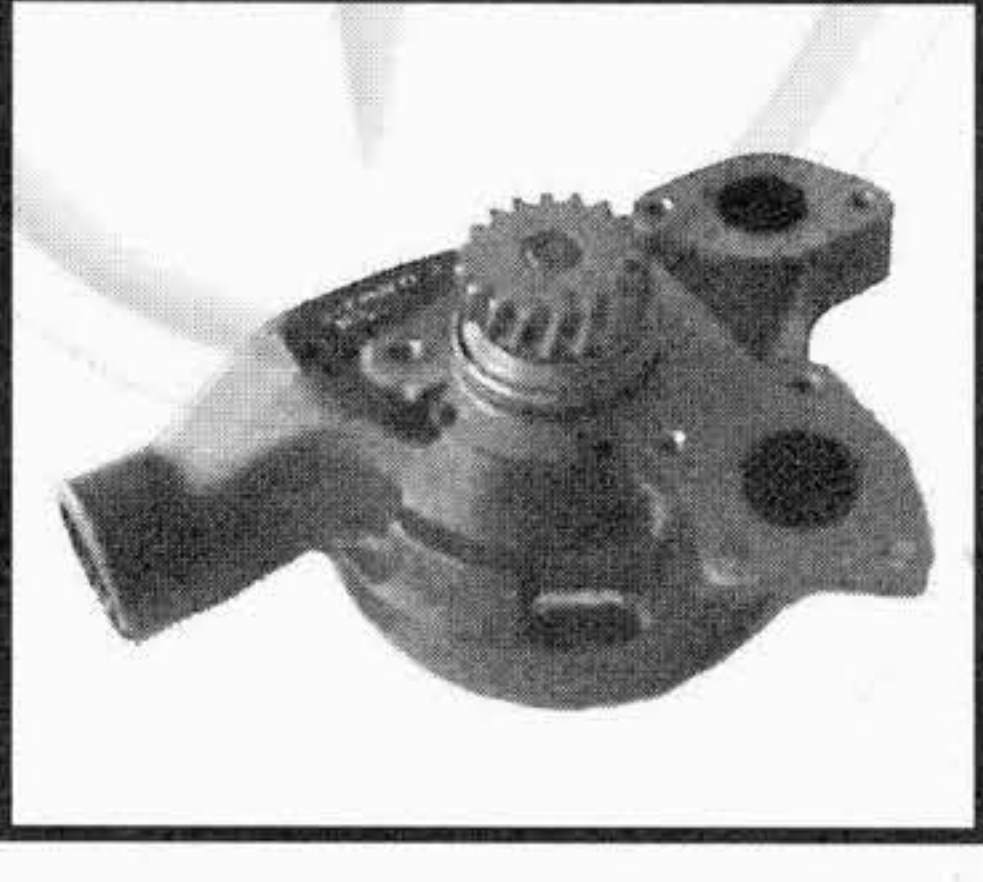
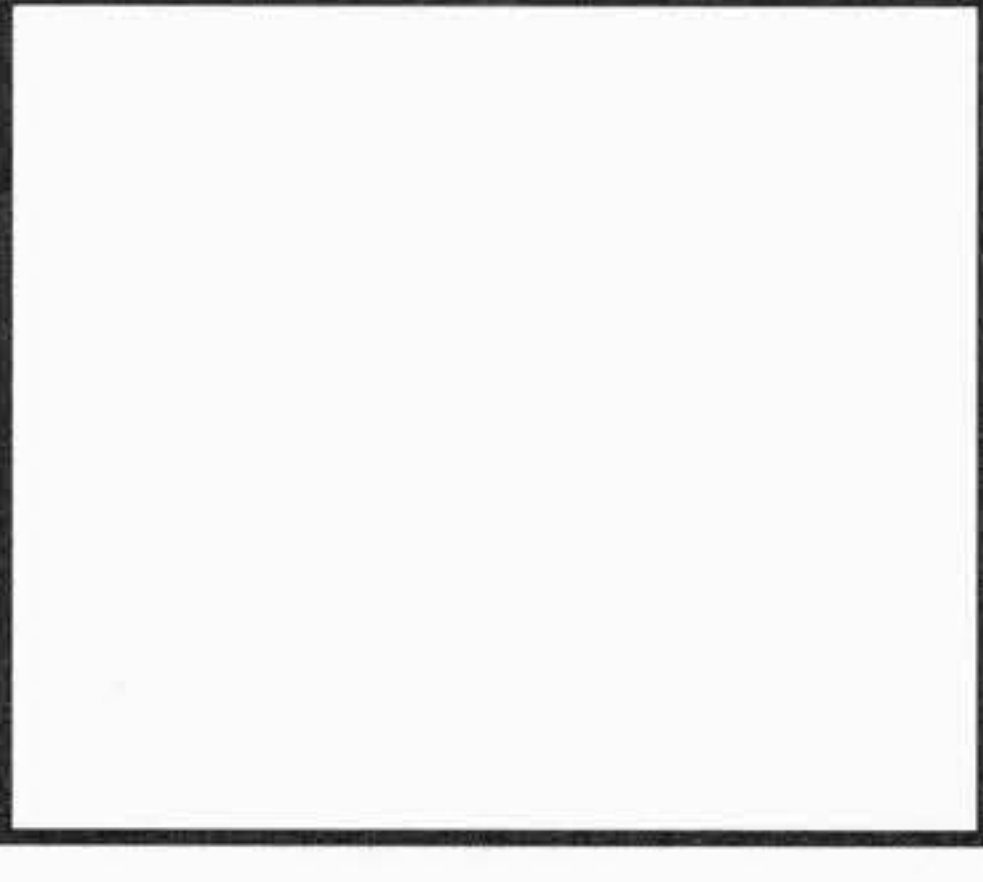
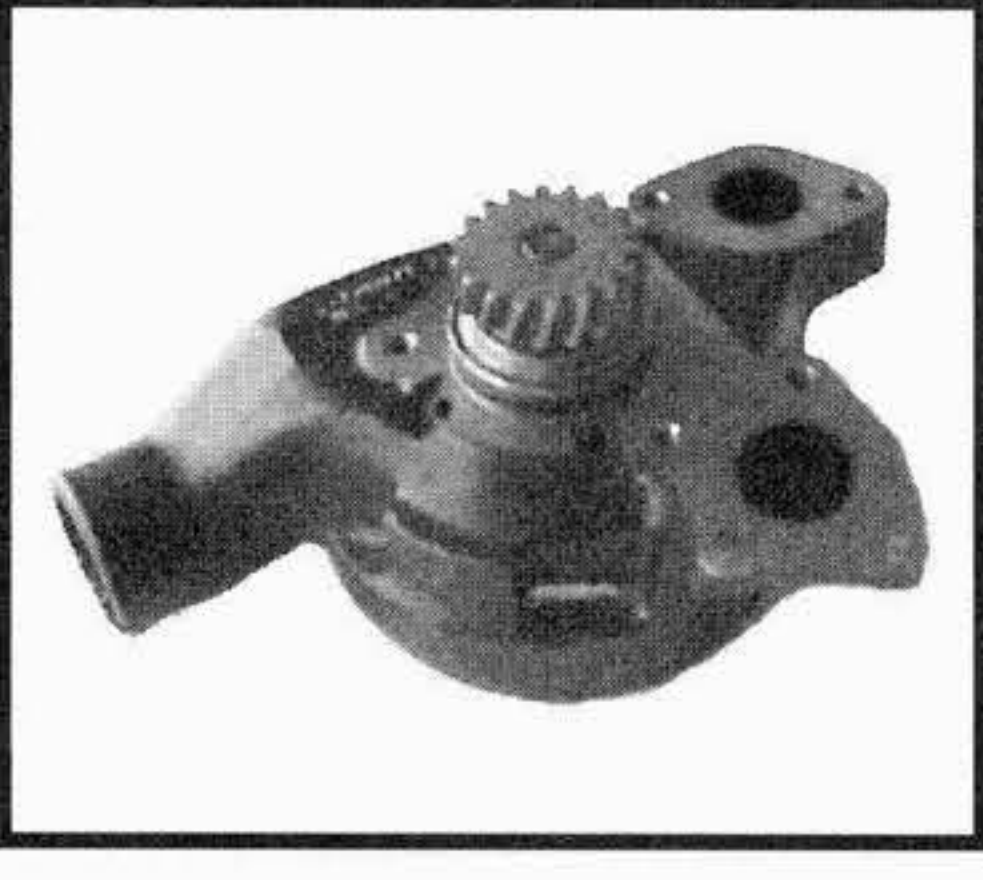
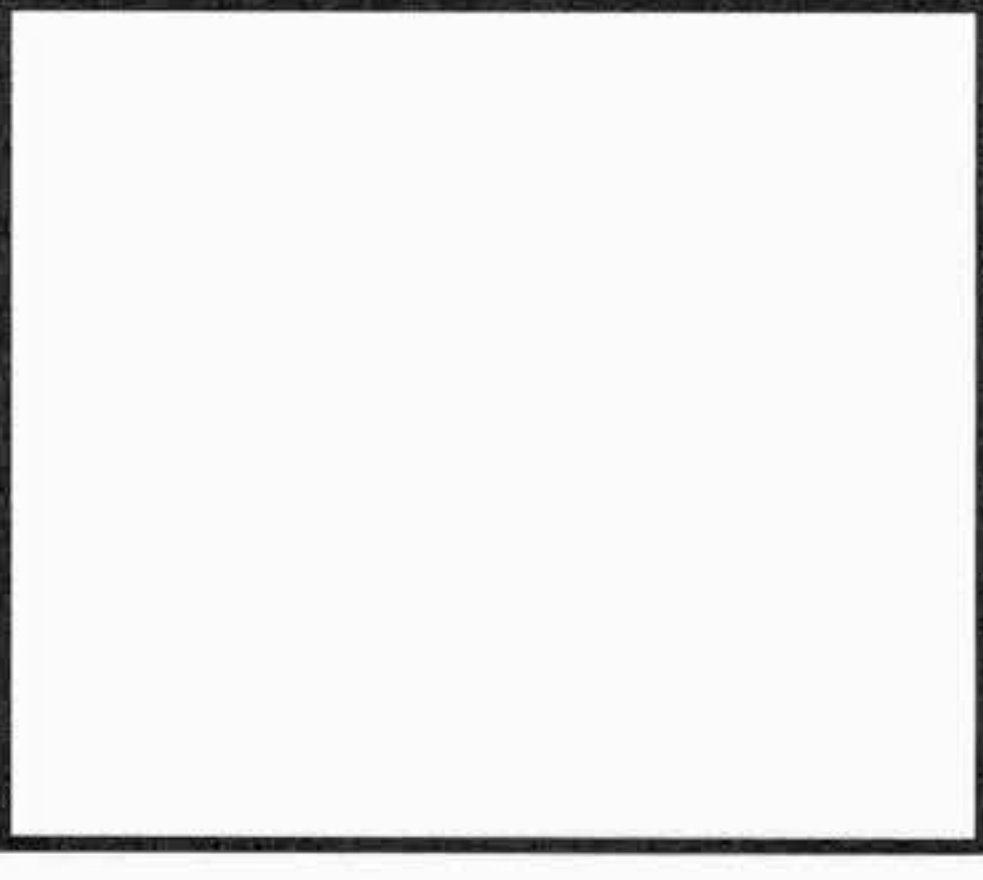
TIPO O MODELLO TYPE OU MODELE TYPE OR MODEL	MOTORE MOTEUR ENGINE	POMPA ACQUA POMPE A EAU WATER PUMP	KIT RIPARAZIONE NECESSAIRE DE REP. REPAIR KIT
	A6.354 A6.354.1 AT6.354.1	<p>159.230 U5MW0016</p> <p>SENZA PULEGGIA / WITHOUT PULLEY</p> 	<p>252.136 U7LW0024</p> 
	6.354.4 A6.354.4 AT6.354.4 T6.354.4	<p>159.355 41313027</p> <p>SENZA PULEGGIA / WITHOUT PULLEY</p> 	<p>152.153 U7LW0015</p> 
<p>NEW !!</p>	1004.4 PHASER 4 cyl.	<p>159.510 4131E012</p> 	<p>152.260 U7LW0071</p> 
<p>NEW !!</p>	1006.6 PHASER 6 cyl.	<p>159.500 4131E011</p> 	<p>152.261 U7LW0087</p> 

I ricambi non sono originali ma adattabili . Ogni riferimento originale é assolutamente indicativo .
 Spare parts are not original but perfectly suitable . Every original part number has to be considered for reference purpose only .



SECTION 35

APPLICATION

RENAULT V.I

RVI

**WATER PUMPS WASSERPUMPEN
POMPE A EAU BOMBA DE AGUA
POMPA ACQUA**

S.P. WATER PUMPS LTD
18 Tatton Court, Kingsland Grange, Woolston,
Warrington, Cheshire. ENGLAND. WAI 4RR
TEL: +44(0) 1925 850082 Fax: +44(0) 1925 850083
Email:sales@spwaterpumps.co.uk Web Site:www.spwaterpumps.co.uk

TAVOLE DI CONVERSIONE
TABLE DE CONVERSION
CONVERSION TABLE

RVI -



NUMERO ORIGINALE NUMERO ORIGINAL ORIGINAL NUMBER	NUMERO SOSTITUTIVO REPLACE PAR NUMERO REPLACED BY NUMBER	RIFERIMENTO OMP REFERENCE OMP OMP REFERENCE
00.00.116.809		273.132
00.00.119.984		273.302
00.00.130.755		273.237
00.00.139.212		273.128
00.00.145.011		273.303
00.00.145.595		273.308
00.00.145.680		273.314
00.00.145.766	50.00.270.232	
00.00.148.849		273.307
00.00.153.859		273.111
00.00.157.274		273.310
00.00.158.206		273.315
00.00.158.207		273.313
00.00.158.208		273.316
00.00.158.544		273.312
00.00.161.287		273.304
00.00.322.245		272.217
00.00.711.144		273.112
00.00.771.143		273.122
00.00.771.518	50.00.663.009	
00.00.773.326	50.00.666.307	
00.00.773.450	00.00.773.983	
00.00.773.796		273.121
00.00.773.798		273.124
00.00.773.926		273.127
00.00.773.983		273.120
00.22.101.055		273.129
00.22.252.101		273.024
00.23.311.021		275.034
00.23.312.048		273.126
00.23.416.304		273.104
00.23.416.355		279.157
00.23.472.303		273.213
00.24.151.139		271.822
00.24.427.346		273.319
00.24.427.390		273.313
00.24.472.544		273.117
00.24.484.032	50.00.813.980	
00.24.484.034		273.173
00.24.484.035		273.116
00.31.424.086	50.00.201.680	
00.33.131.625		273.257
00.35.129.032		273.182
00.36.881.176		273.107
06.03.865.700		273.258
06.03.865.900		273.262
06.06.526.100		273.259

NUMERO ORIGINALE NUMERO ORIGINAL ORIGINAL NUMBER	NUMERO SOSTITUTIVO REPLACE PAR NUMERO REPLACED BY NUMBER	RIFERIMENTO OMP REFERENCE OMP OMP REFERENCE
07.02.980.400		279.041
07.70.630.423		273.029
08.24.413.700		273.228
08.55.200.300		271.191
08.70.078.200		273.216
09.48.360.954		273.133
09.48.361.026		273.114
09.48.571.033		273.234
09.87.044.900		273.250
09.87.045.300		273.180
09.87.045.400		273.190
09.87.057.700		273.255
50.00.040.416		273.201
50.00.041.167		273.191
50.00.041.235		273.214
50.00.041.236		273.212
50.00.041.237		279.028
50.00.041.443		273.225
50.00.041.446		273.209
50.00.042.025		273.188
50.00.042.140		273.235
50.00.042.141		273.194
50.00.042.146		273.197
50.00.043.832	50.00.042.140	
50.00.043.905		273.217
50.00.043.907		273.206
50.00.043.909		273.184
50.00.043.910		273.189
50.00.043.911		273.183
50.00.043.913	50.00.667.231	
50.00.046.100		273.001
50.00.046.101		273.014
50.00.046.102		273.015
50.00.046.105		273.019
50.00.046.106		273.009
50.00.046.107		273.011
50.00.046.108		273.064
50.00.046.109		273.048
50.00.046.110		273.067
50.00.046.112	KIT 775.010	273.066
50.00.046.116	KIT 775.520	273.059
50.00.046.131	KIT 775.010	273.087
50.00.046.525	50.00.815.825	
50.00.048.145		273.224
50.00.133.667		273.236
50.00.165.289		273.085
50.00.165.564		273.031

OGNI RIFERIMENTO ORIGINALE E' ASSOLUTAMENTE INDICATIVO. CHAQUE REFERENCE ORIGINAL EST ABSOLUMENT INDICATIVE. EVERY ORIGINAL PART NUMBER HAS TO BE CONSIDERED FOR REFERENCE PURPOSE ONLY.

TAVOLE DI CONVERSIONE
 TABLE DE CONVERSION
 CONVERSION TABLE

RVI -



NUMERO ORIGINALE NUMERO ORIGINAL ORIGINAL NUMBER	NUMERO SOSTITUTIVO REPLACE PAR NUMERO REPLACED BY NUMBER	RIFERIMENTO OMP REFERENCE OMP OMP REFERENCE
50.00.201.680		273.101
50.00.203.159		273.245
50.00.247.222		272.208
50.00.247.561		273.240
50.00.254.609		273.002
50.00.254.848		271.381
50.00.255.187		273.079
50.00.257.229		273.072
50.00.270.031		273.027
50.00.270.032		273.028
50.00.270.034	50.00.815.826	
50.00.270.230		273.076
50.00.270.231		273.078
50.00.270.232		273.077
50.00.270.326		272.111
50.00.270.327		272.101
50.00.270.407		272.109
50.00.270.409	50.00.273.543	
50.00.270.928	50.00.336.332	
50.00.273.543		272.110
50.00.273.750		273.045
50.00.273.791	50.00.336.331	
50.00.273.838		273.065
50.00.277.190	50.338.520	
50.00.277.400		273.049
50.00.277.401	50.00.815.828	
50.00.277.402	KIT 777.520	273.051
50.00.277.464		273.038
50.00.277.912		273.013
50.00.278.310		273.012
50.00.279.683	50.00.815.827	
50.00.279.907	50.00.336.333	
50.00.280.314		273.017
50.00.280.631		273.081
50.00.280.636	KIT 777.825	
50.00.280.678	50.00.281.838	
50.00.280.679		271.837
50.00.280.680	50.00.286.221	
50.00.280.684		271.786
50.00.280.692	KIT 777.825	
50.00.281.216		271.799
50.00.281.838		273.230
50.00.281.952		271.821
50.00.282.076		271.826
50.00.282.215		272.162
50.00.283.267	50.00.815.829	
50.00.283.308		273.082

NUMERO ORIGINALE NUMERO ORIGINAL ORIGINAL NUMBER	NUMERO SOSTITUTIVO REPLACE PAR NUMERO REPLACED BY NUMBER	RIFERIMENTO OMP REFERENCE OMP OMP REFERENCE
50.00.283.390		273.036
50.00.284.670		271.798
50.00.286.186		273.260
50.00.286.187	KIT 777.825	
50.00.286.221		271.858
50.00.288.046	50.01.833.230	
50.00.297.602		276.465
50.00.336.069		272.102
50.00.336.296		272.106
50.00.336.331		273.070
50.00.336.332		273.035
50.00.336.333		273.040
50.00.338.001		273.232
50.00.338.021		273.233
50.00.338.059		273.100
50.00.338.060		272.174
50.00.338.520		273.050
50.00.587.189		279.028
50.00.658.281		273.138
50.00.658.282		273.137
50.00.663.009		273.110
50.00.663.010		273.109
50.00.663.118		273.135
50.00.663.121		273.300
50.00.666.307		273.123
50.00.667.231		273.145
50.00.670.157		273.130
50.00.670.467		273.305
50.00.670.630		273.149
50.00.681.283		273.340
50.00.681.872	50.00.694.289	
50.00.694.289		273.365
50.00.785.348		273.134
50.00.786.743	50.00.670.630	
50.00.786.746		273.148
50.00.793.895	50.10.258.977	
50.00.806.634		279.450
50.00.807.860	50.00.813.420	
50.00.813.420	50.00.288.046	
50.00.813.980		273.115
50.00.815.825		273.062
50.00.815.826		273.003
50.00.815.827		273.021
50.00.815.828		273.075
50.00.823.146		273.355
50.00.832.904		273.330
50.01.001.274		276.549

OGNI RIFERIMENTO ORIGINALE E' ASSOLUTAMENTE INDICATIVO. CHAQUE REFERENCE ORIGINAL EST ABSOLUMENT INDICATIVE. EVERY ORIGINAL PART NUMBER HAS TO BE CONSIDERED FOR REFERENCE PURPOSE ONLY.

SUITABLE







RVI

RENAULT V. I. AUTOCARRI

Tel:+44(0)1925 850082 Fax: +(0)44 1925 850083

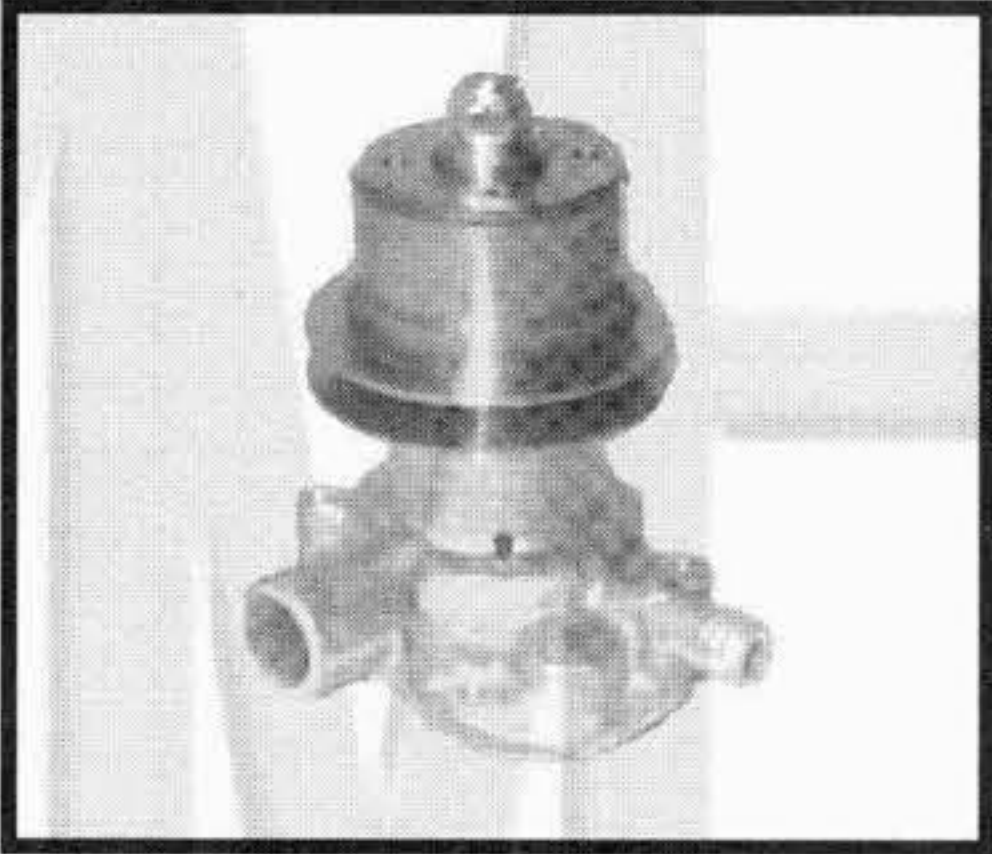
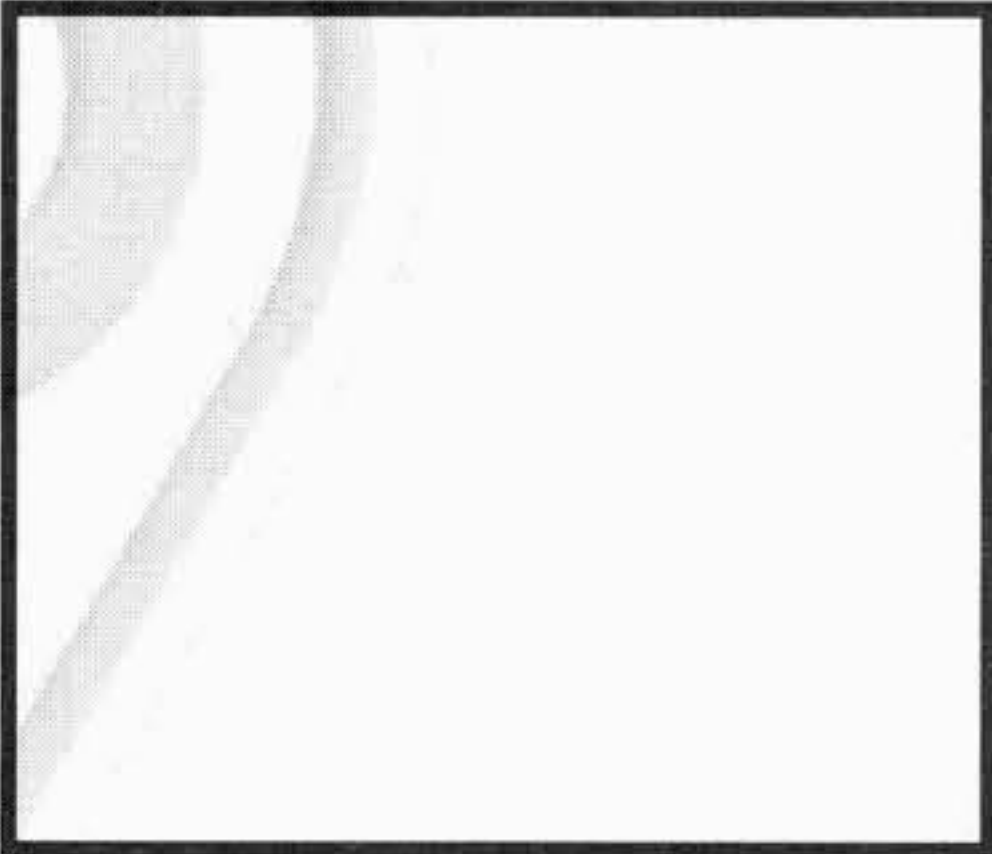
www.spwaterpumps.co.uk



TIPO O MODELLO TYPE OU MODELE TYPE OR MODEL	MOTORE MOTEUR ENGINE	POMPA ACQUA POMPE A EAU WATER PUMP OMP REF. / O.EM. REF	KIT RIPARAZIONE NECESSAIRE DE REP. REPAIR KIT OMP REF. / O.EM. REF
SG 2 - SG 3 - SG 4 SG 5 - SG 5 C S 5 B - SM 5	712.01.07.000 712.02.07.020 712.01.02.002	273.180 09.87.045.300 	272.102 50.00.336.069 
SG 3 - SG 4 TP 2 (4 x 4) - TP 3 (4 x 4) SG 5 - SG 5 C S 5 B - SM 5	712.01.07.003 E 712.01.07 720.01.02.002	273.250 09.87.044.900 	272.102 50.00.336.069 
S 5 B - SM 5	591	273.240 50.00.247.561 	272.104 --- 
S 5 B - SM 5	591.04	273.190 09.87.045.400 	272.102 50.00.336.069 

I ricambi non sono originali ma adattabili . Ogni riferimento originale é assolutamente indicativo .
Spare parts are not original but perfectly suitable . Every original part number has to be considered for reference purpose only .

SUITABLE



RVI

RENAULT V.I. AUTOCARRI -

Tel:+44(0)1925 850082 Fax: +(0)44 1925 850083

www.spwaterpumps.co.uk

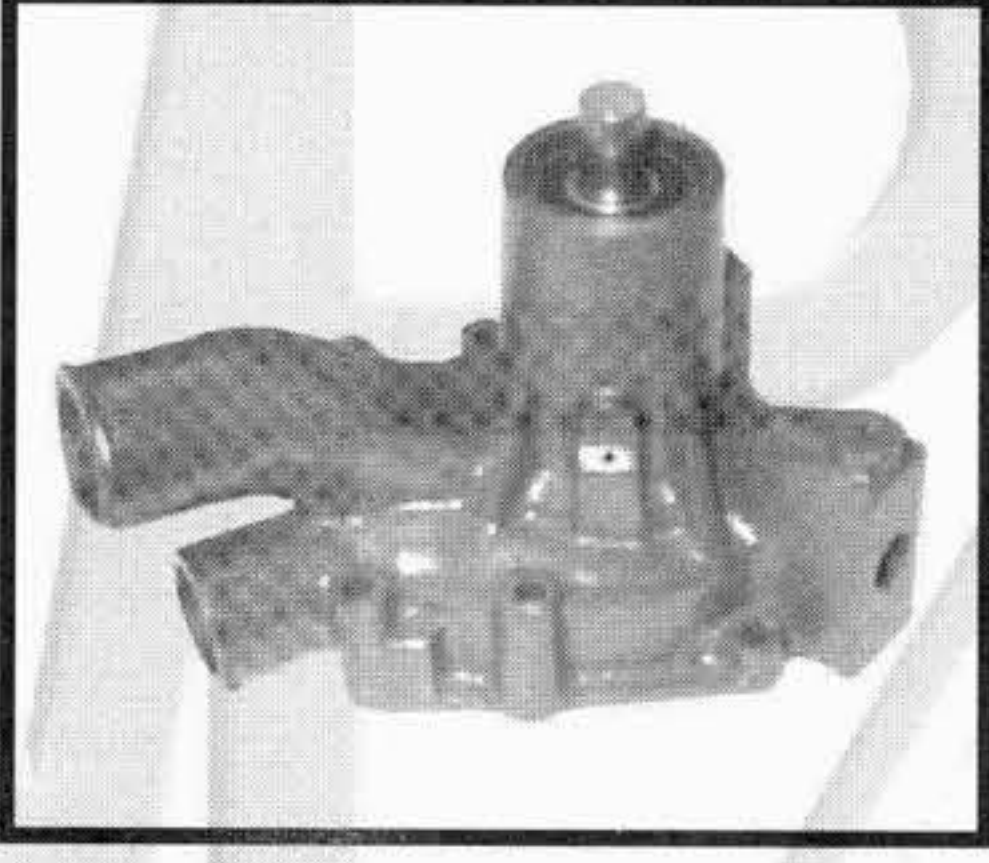
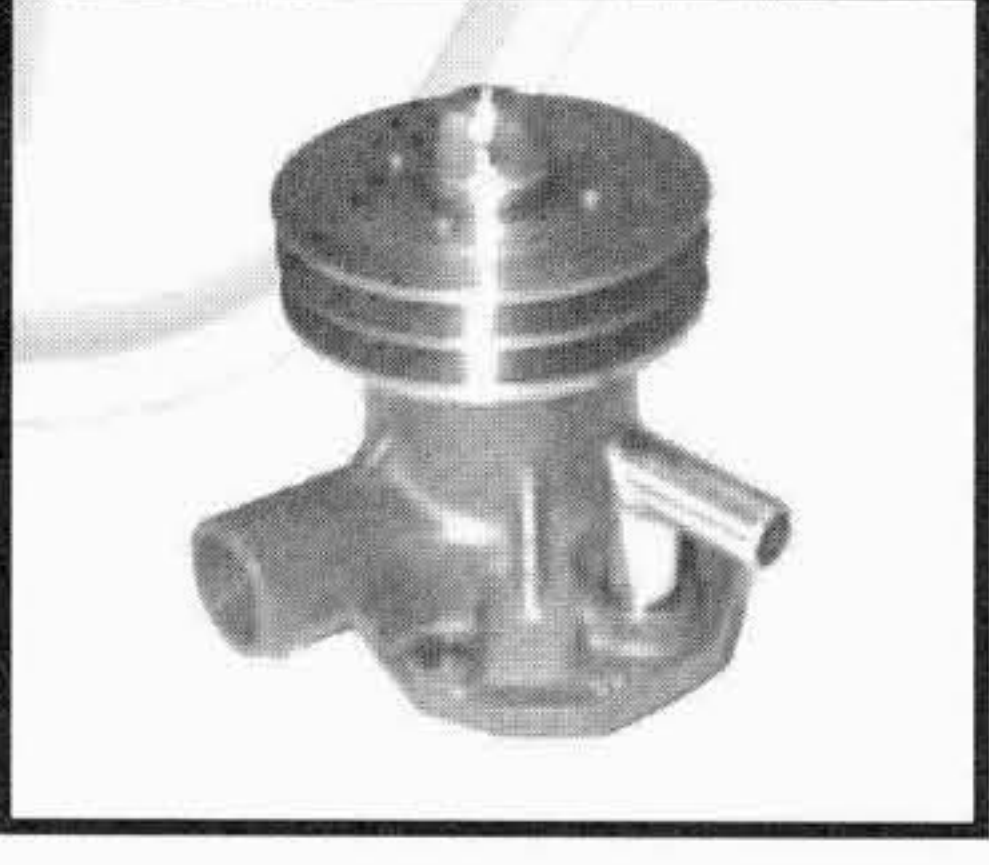

TIPO O MODELLO TYPE OU MODELE TYPE OR MODEL	MOTORE MOTEUR ENGINE	POMPA ACQUA POMPE A EAU WATER PUMP	KIT RIPARAZIONE NECESSAIRE DE REP. REPAIR KIT
<p>TRAFIC</p> <p>MASTER</p> <p>1981 --></p>	<p>4 cyl. 2500 cm³</p>	<p>276.549 50.01.001.274</p> 	<p>NON DISPONIBILE NOT AVAILABLE</p>
<p>SM 6 - SM 7 - SM 8 (4x4) SM 7 - SM 8 - SM 8 (4x4) JE 9 - JE 11 - JE 13 - JE 13 (4x4) SM 13 - SM 13 A JP 11 - 130 B11 - JP 13 A - 130 B13 JP 14 BOM - 130 B 14 JP 13B - 150 B11 - J 13C - 150 B13 JR 19A - JR 19 B - 150 B 13 R JR 21 A / B / C - 150 TB 19 / 20 / 21 JX 21 A / B / C - 130 TB 19 / 20 / 21 JN 60 - 130 B 6 - JN 60 A - 130 B 6 A JN 80 - JN 90 - 130 B9 - JN95 - 130 B9A 95.130 - 110.130 (6 X 6) - 110.150 (4X 4) S130.06 - S130.08 - S130.09 - S130.11 - S130.13 - S130.14 S150.06 - S150.08 - S150.09 - S150.11 - S150.13 - S150.14 S 110 - S 150 - S 150TI GB 131 - HR 15 G170.15 - G170.16D - G170SP - S170 - S170T - S170SP TRM 4000</p>	<p>597.10.131.02 - 597.14.132.12 797 - 798.10 797.20 - 797.26 597.10 - 797.11 797.26 797.28 798.10 798.10 797.26 797.26 - 798.10 797.20 798.20 797.21 797.26 MIDR 06.02.12 797.18</p>	<p>273.100 50.00.338.059</p> 	<p>272.174 50.00.338.060</p>
<p>J 35 - A 15 - A 35</p>	<p>AVIA 712</p>	<p>273.330 50.00.832.904</p> 	<p>NON DISPONIBILE NOT AVAILABLE</p>
<p>SM 10 - SM 12</p> <p>SM 170 - SM 170 M</p>	<p>D 0836 HMN</p> <p>D 0846 HMN</p>	<p>273.045 50.00.273.750</p> 	<p>272.111 50.00.270.326</p> <p>273.062 50.00.815.825 albero completo / complete shaft</p>

I ricambi non sono originali ma adattabili . Ogni riferimento originale é assolutamente indicativo .
Spare parts are not original but perfectly suitable . Every original part number has to be considered for reference purpose only .

SUITABLE



RVI

RENAULT V.I. AUTOCARRI

Tel:+44(0)1925 850082 Fax: +(0)44 1925 850083

www.spwaterpumps.co.uk

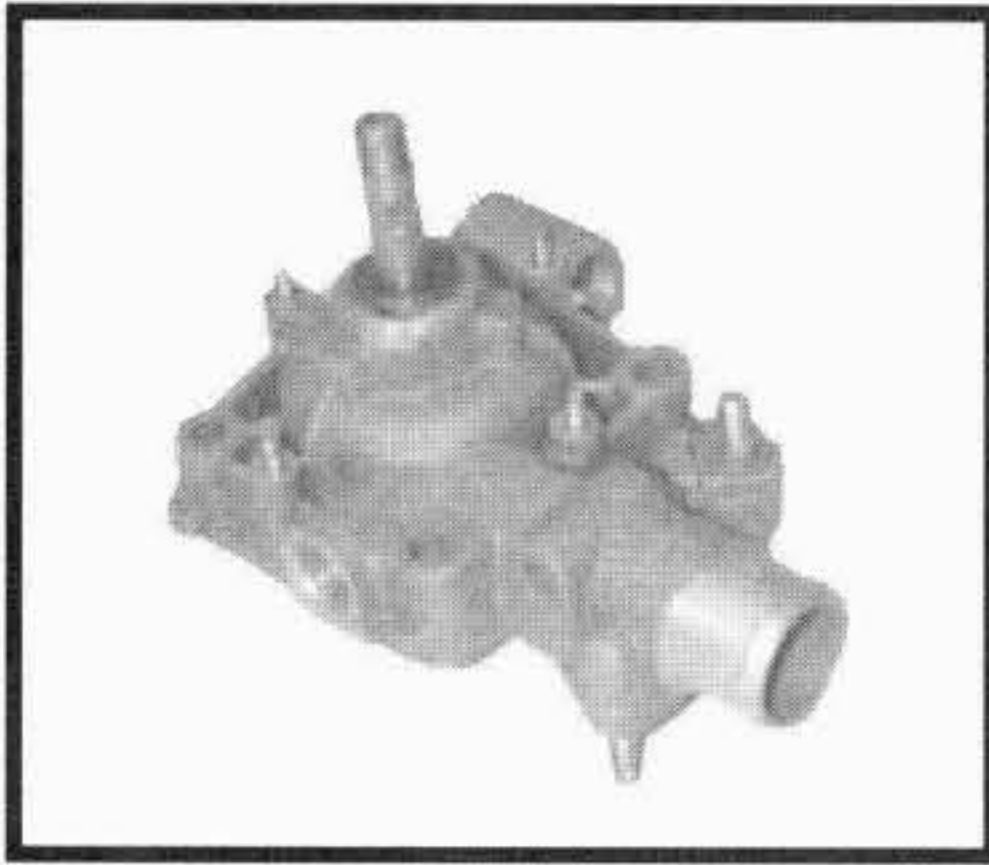
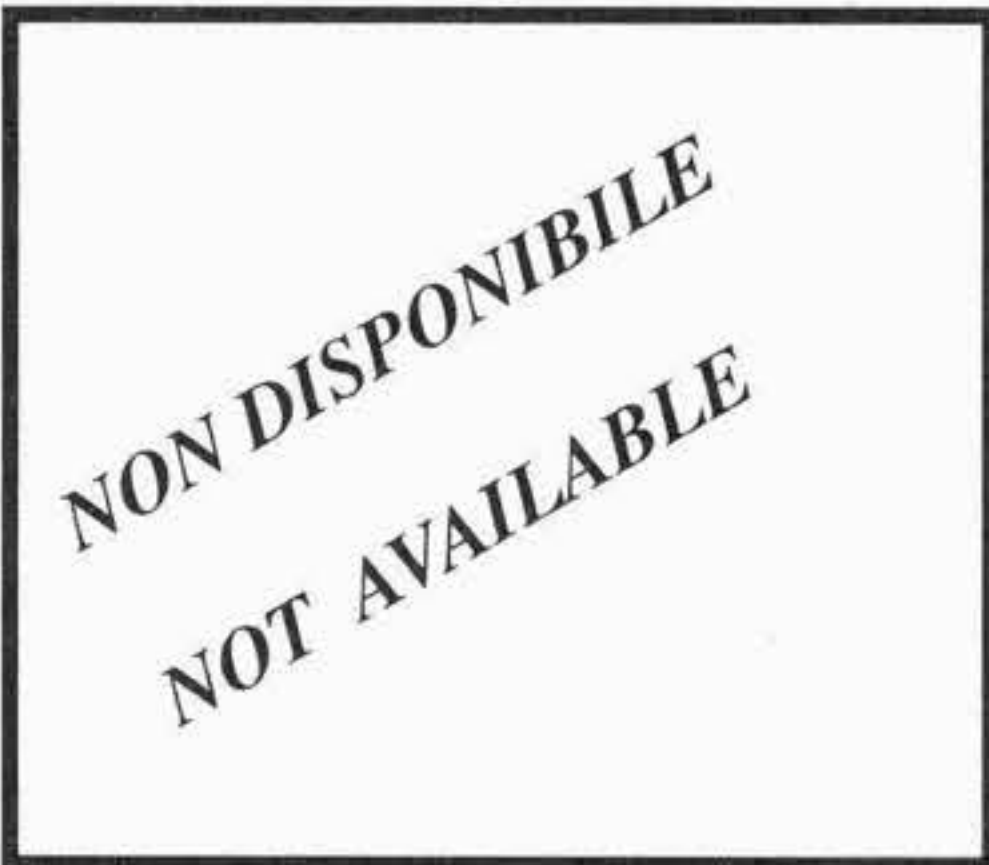
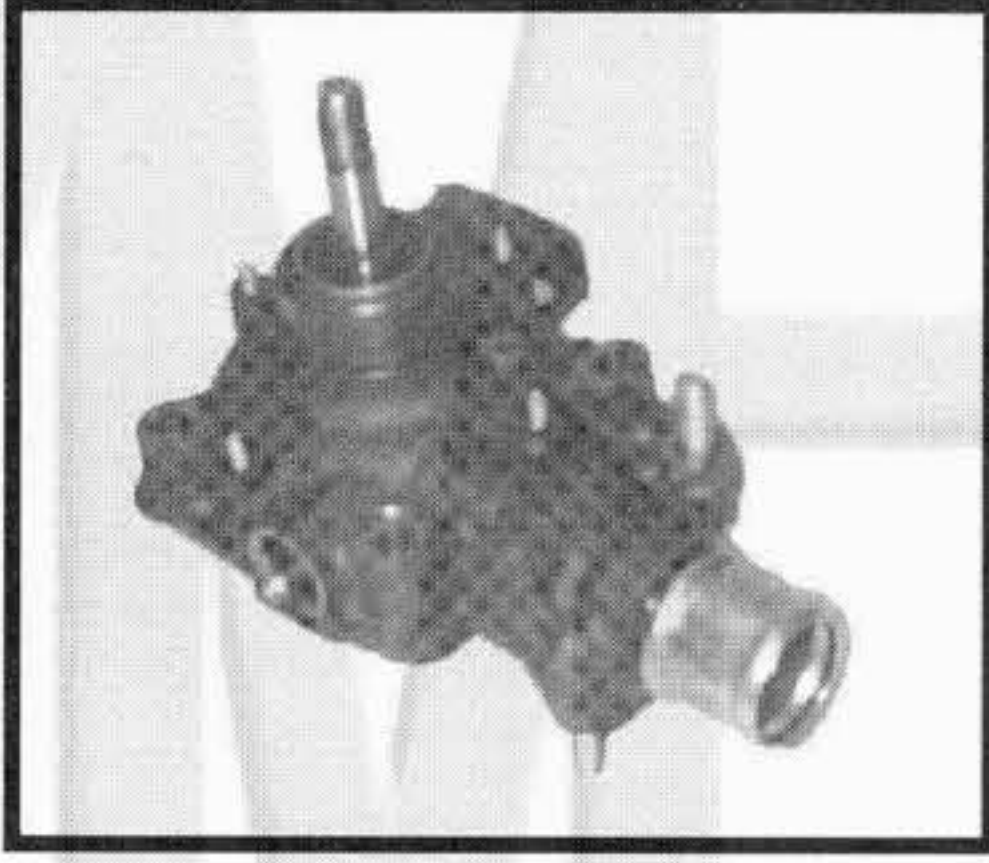
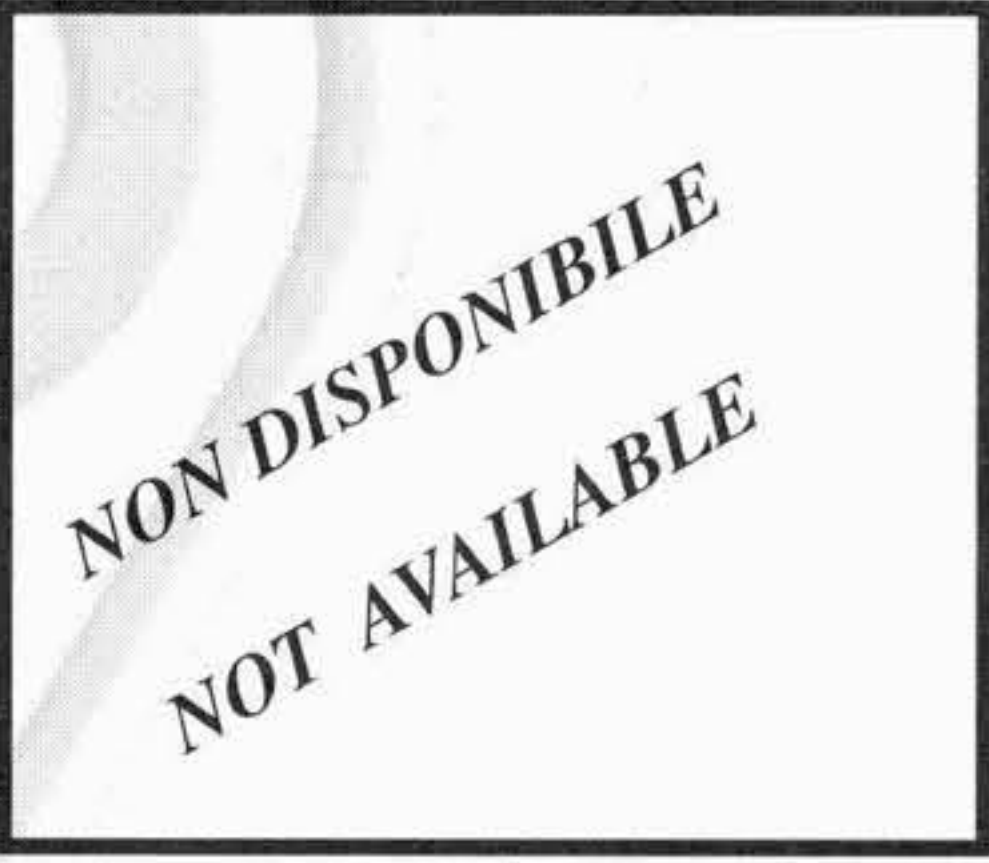
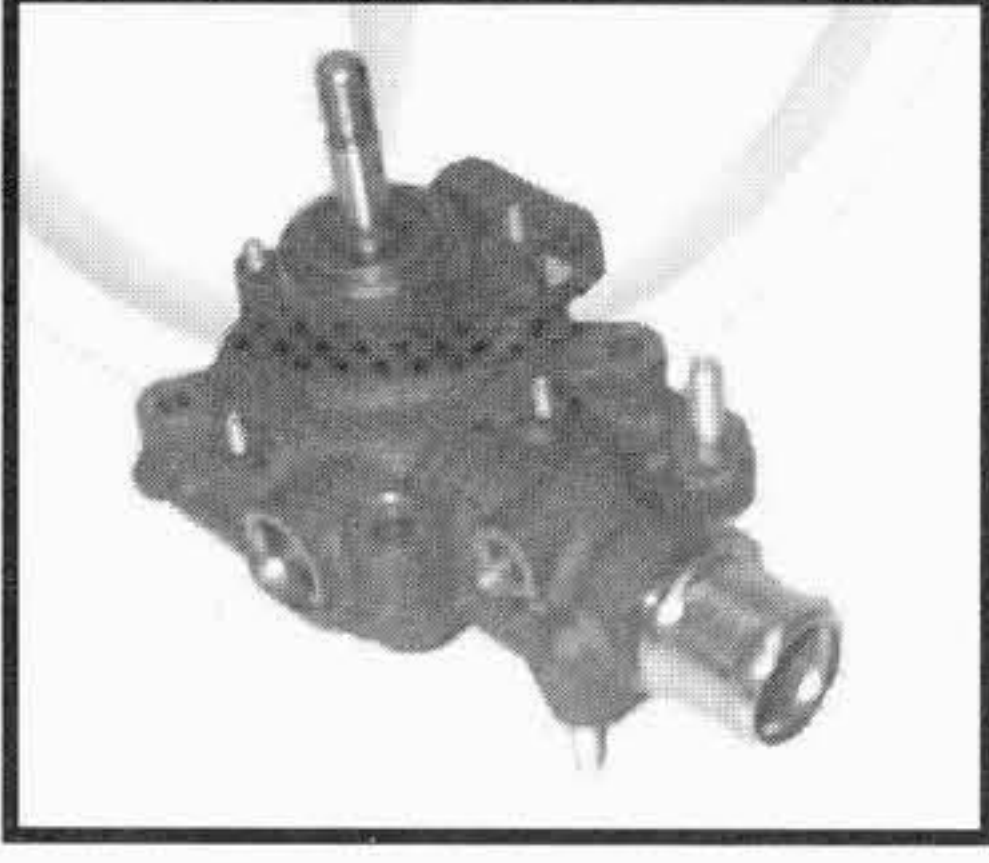

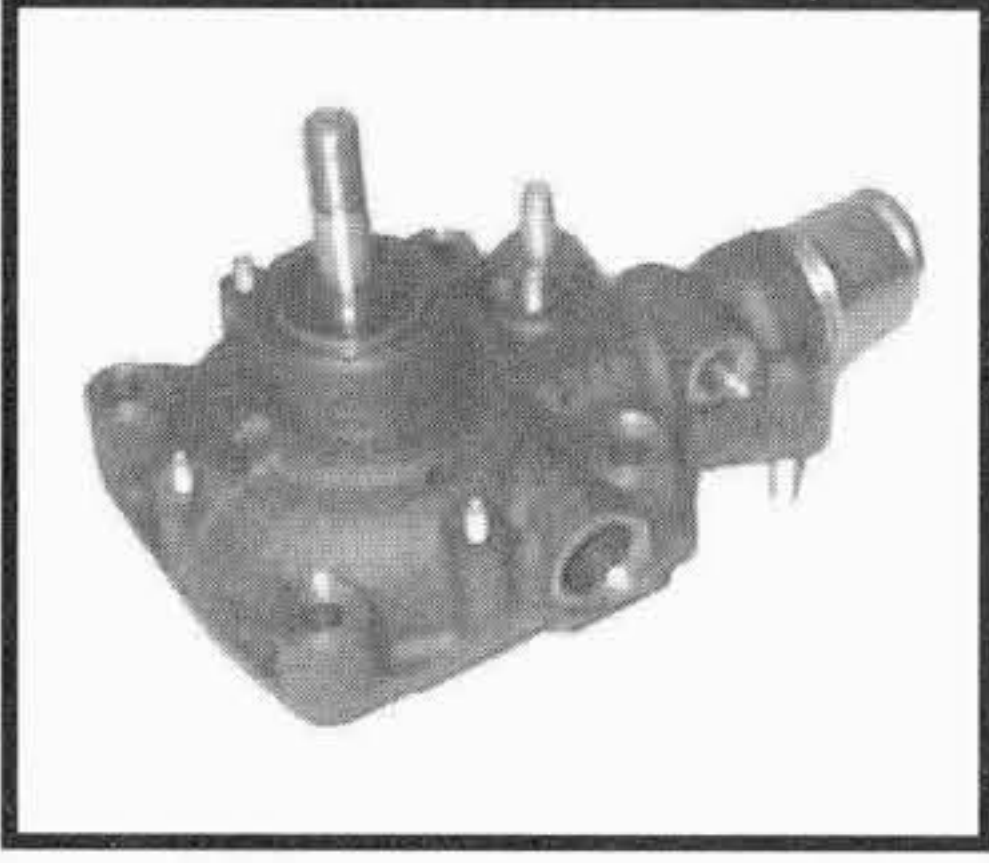
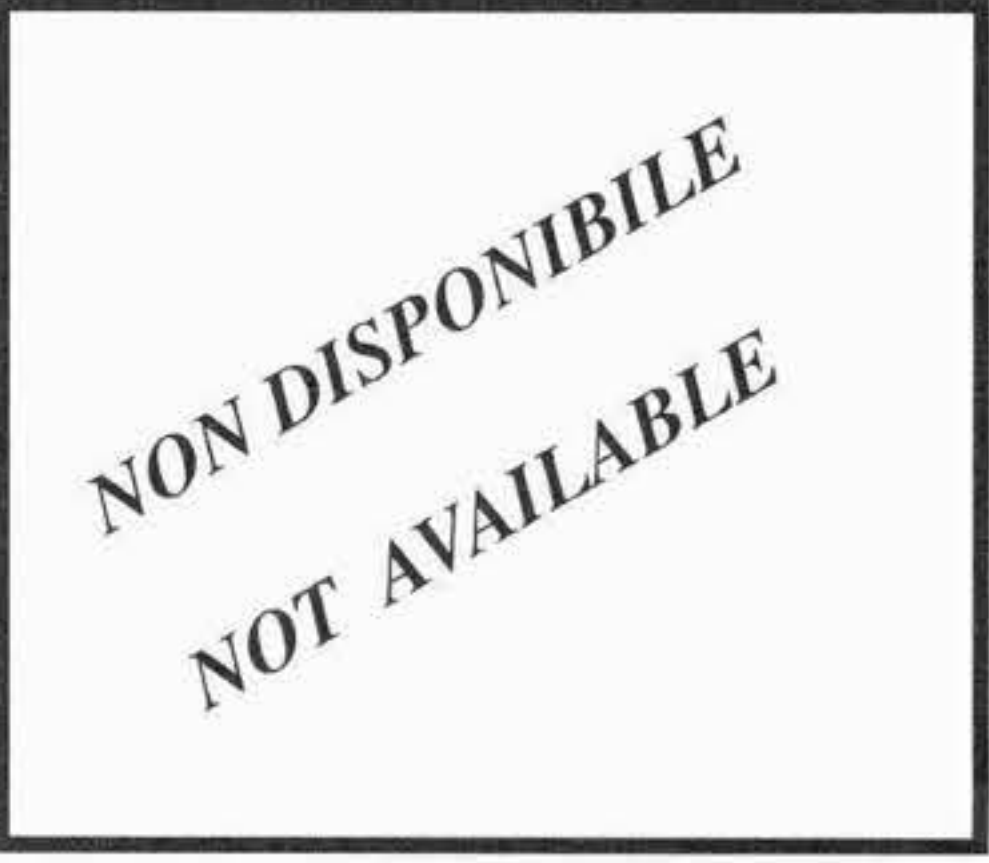
TIPO O MODELLO TYPE OU MODELE TYPE OR MODEL	MOTORE MOTEUR ENGINE	POMPA ACQUA POMPE A EAU WATER PUMP OMP REF. / O.EM. REF	KIT RIPARAZIONE NECESSAIRE DE REP. REPAIR KIT OMP REF. / O.EM. REF
B 70 B 90 <i>con elettroventilatore avec ventilateur electric with electric fan</i>	4 cyl. 2500 cm ³	276.230 50.01.833.230 	
B 80 B 110 B 120 15 / 05 / 91 ---> 06 / 94 <i>con elettroventilatore avec ventilateur electric with electric fan</i>	4 cyl. 2500 cm ³ turbo EURO 0	276.465 50.00.297.602 	
B 80 B 110 B 120 <i>con elettroventilatore avec ventilateur electric with electric fan</i>	4 cyl. 2500 cm ³ turbo intercooler EURO 1 & 2 4 cyl. 2800 cm ³ turbo intercooler	276.460 50.01.831.466 	
B 110 4 x 4 1993 ---> <i>con elettroventilatore avec ventilateur electric with electric fan</i>	8140.27.2565	276.427 50.01.830.275 	

I ricambi non sono originali ma adattabili . Ogni riferimento originale é assolutamente indicativo .
 Spare parts are not original but perfectly suitable . Every original part number has to be considered for reference purpose only .

SUITABLE







RVI

RENAULT V.I. AUTOCARRI

Tel:+44(0)1925 850082 Fax: +(0)44 1925 850083

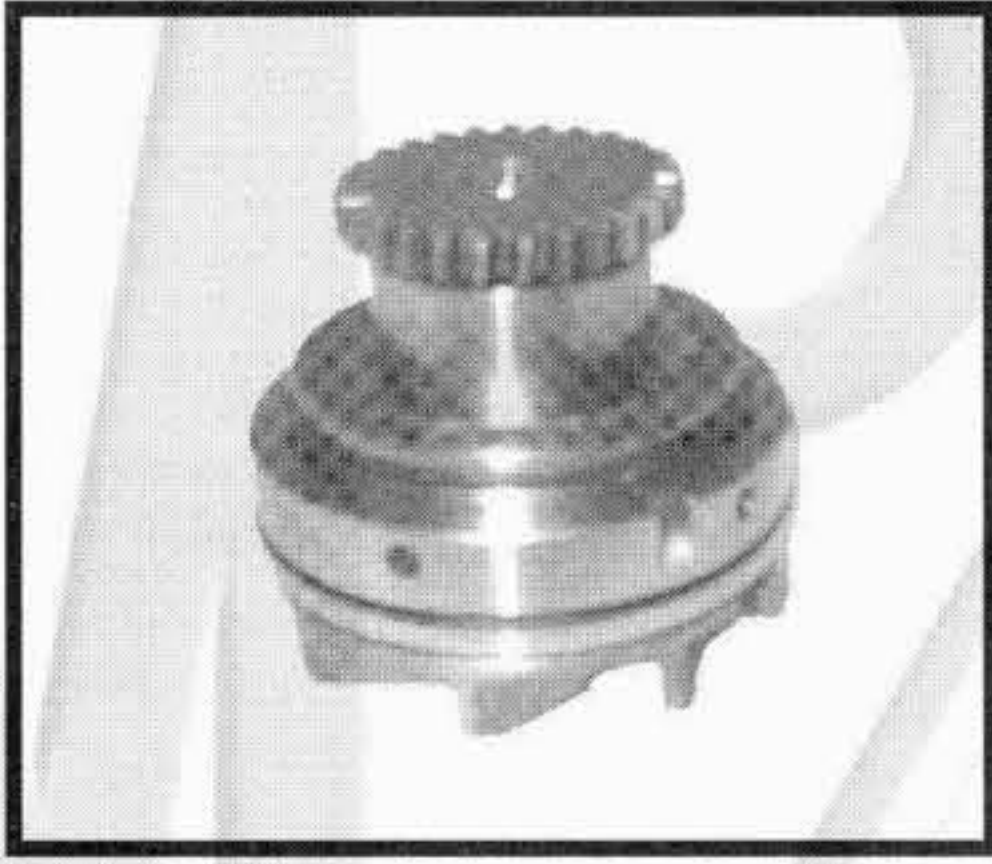
www.spwaterpumps.co.uk

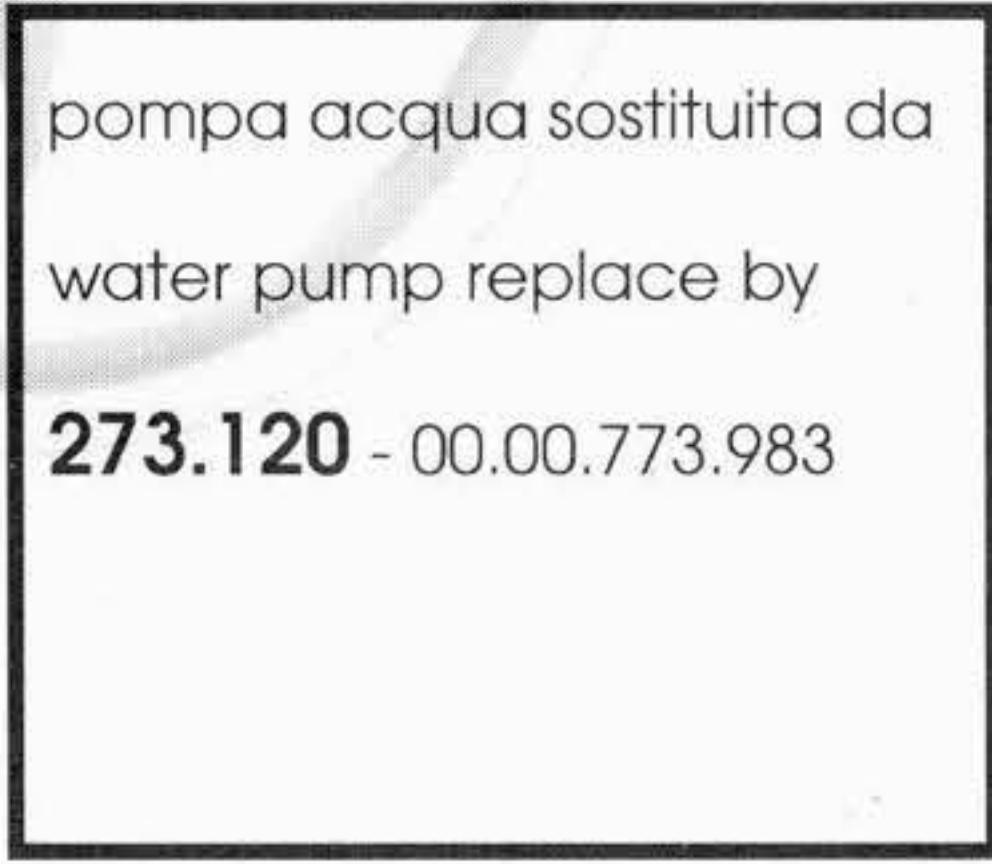

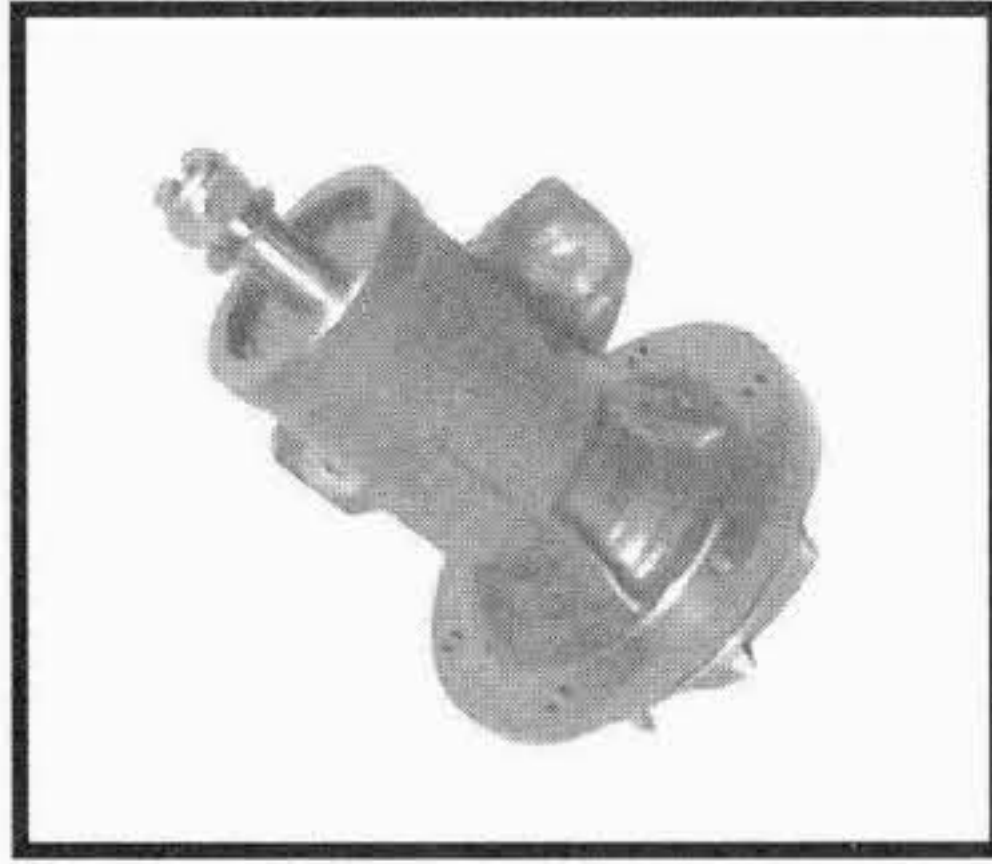
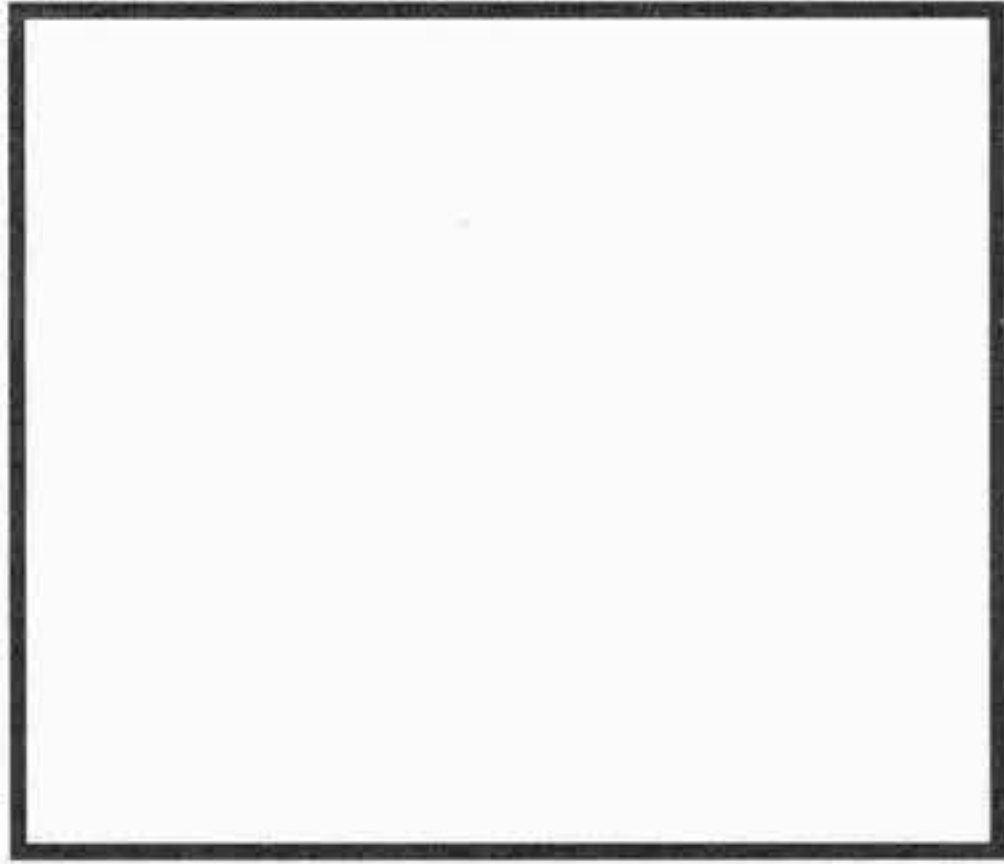
TIPO O MODELLO TYPE OU MODELE TYPE OR MODEL	MOTORE MOTEUR ENGINE	POMPA ACQUA POMPE A EAU WATER PUMP	KIT RIPARAZIONE NECESSAIRE DE REP. REPAIR KIT
JK 50 JK 60 A - B - 90 B 6 - B 6 Z JK 65 - 90 B 6 A JK 75 - 90 B 7 - 75.130 (4 x 4) JN 85 - 90 B 8 S 90.09	720.12	273.255 09.87.057.700 	272.106 50.00.336.296 
GLC 190 - GLR 190 PGC 191 - GR 191 - HB19 GC 191 - GF 191 - HB17 GB 191 - HB15 - TB 191 - HB26T GLR 230 PGC 231 - GR 231 - HB19 GC 231 - GF 231 - HF17 GB 231 - HF15 - TB 231 - HF26T TF 231 D GLR 230 (4 x 4) GRH 235 - HF26V GRH 235 R - HF26V R 770 KB6 FPT - 770 KB6 EAP30 15.05.81->	MID 06.20.30 MIDS 06.20.30 TURBO MIDS 06.20.30 MID 06.20.30	273.110 50.00.663.009 	
GBC 8 M3 (6 x 4 / 6 x 6) GCK 8 - GCK 8 R GCK 160 - GRB - L 64 - TAK 8/160 GBC 160 MT (6 x 6) GBH 260 (6 x 6) TBH 280 (6 x 6) ---> 15.03.79 GBH 280 (6 x 6) GR 280 / PX28 - TR 280 / PX28 -> 15.03.79 GRH 305 (6 X 4) PX30V -> 15.03.79 TRH 305 (6 X 4) PX30VT-> 15.03.79 TR 305 / PX30T ---> 15.03.79 GR 305 / PX30 ---> 15.03.79	M 520 M 520 B MD06.35.40 MIDS 06.35.40 MDS 06.35.40 MDS 06.35.40 MDR 06.35.40 MIDR 06.35.40 MDR 06.35.40A MIDR 06.35.40 B	--- 00.00.773.450 pompa acqua sostituita da water pump replace by 273.120 - 00.00.773.983 	272.217 00.00.322.245 
GBH 260 (6 x 6) TBH 280 (6 x 6) 16.03.79 ---> GBH 280 (6 x 6) GR 280 / PX28 - TR 280 / PX28 16.03.79-> GLM 280 - TLM 280 GBH 280 (6 X 4) - TBH 280 (6 X 4) GRH 305 (6 X 4) PX30V 16.03.79-> TRH 305 (6 X 4) PX30VT 16.03.79-> TR 305 / PX30T 16.03.79 ---> GR 305 / PX30 16.03.79 ---> R 310 - R310T - R310TD (4x2/ 6x4)	MD06.35.40 MIDS 06.35.40 MDS 06.35.40 MDS 06.35.40 MIDS 06.35.40 MIDS 06.35.40 MDR 06.35.40 MIDR 06.35.40 MDR 06.35.40A MIDR 06.35.40 MIDR 06.35.40	273.120 00.00.773.983 	272.218 --- 

I ricambi non sono originali ma adattabili . Ogni riferimento originale é assolutamente indicativo .
 Spare parts are not original but perfectly suitable . Every original part number has to be considered for reference purpose only .

SUITABLE





RVI

RENAULT V.I. AUTOCARRI

Tel:+44(0)1925 850082 Fax: +(0)44 1925 850083

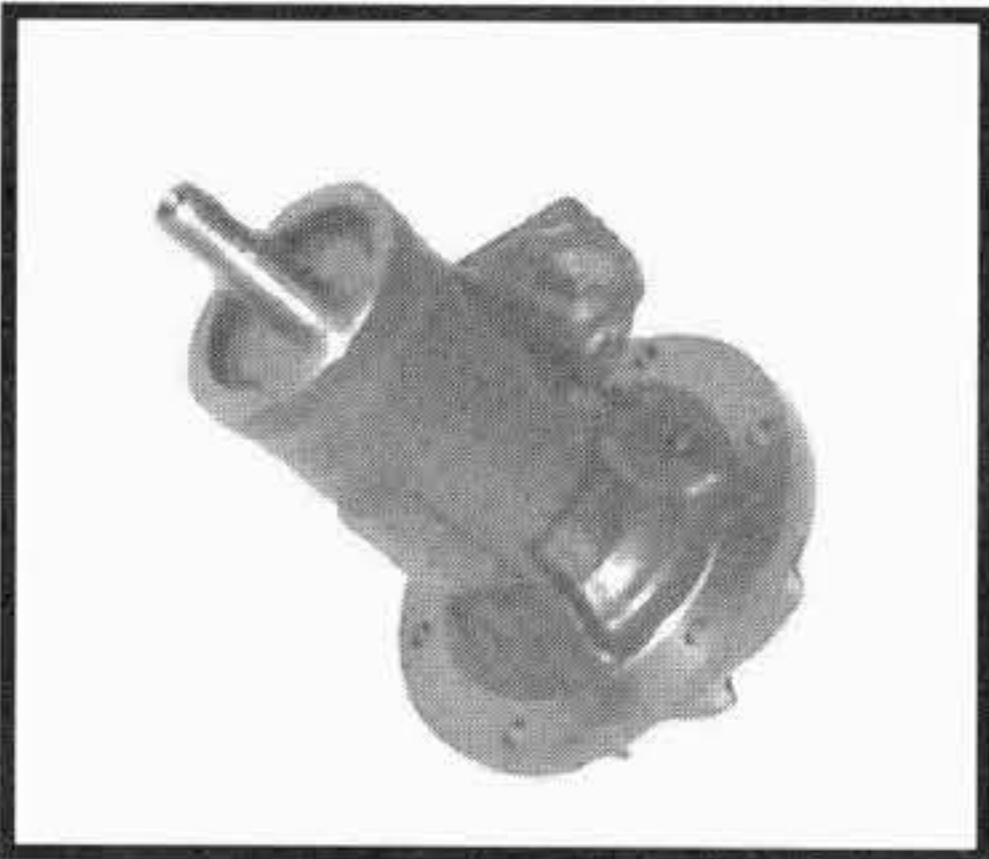
www.spwaterpumps.co.uk

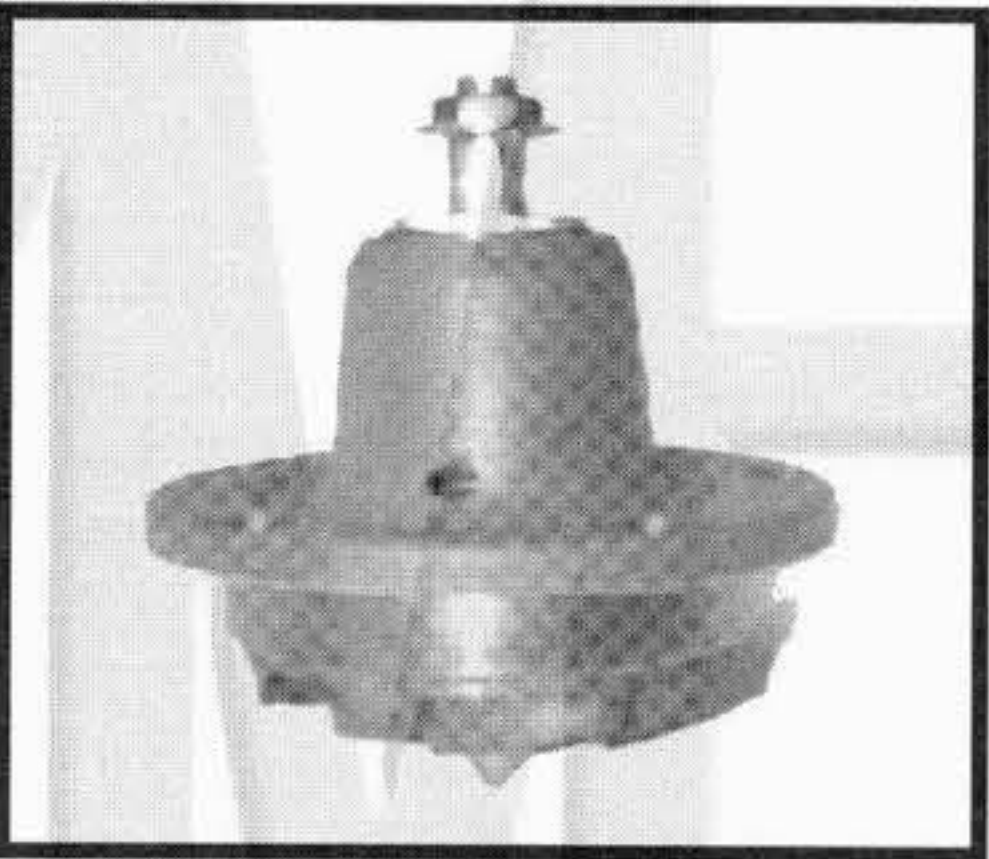
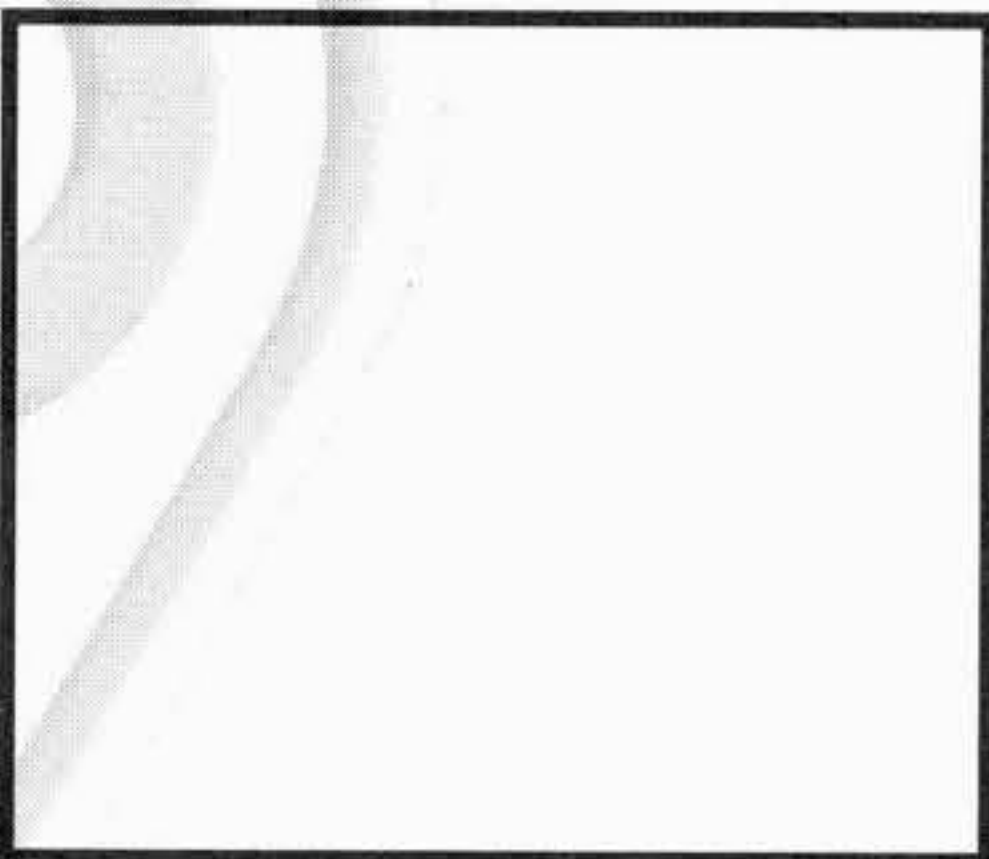

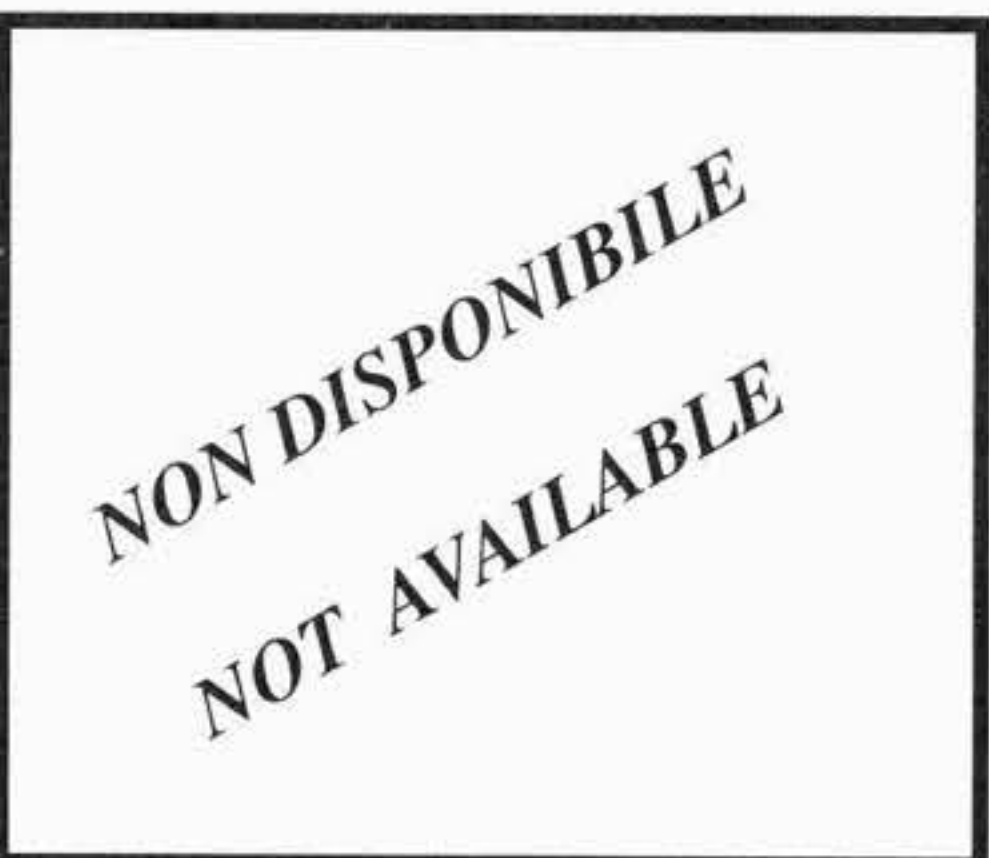
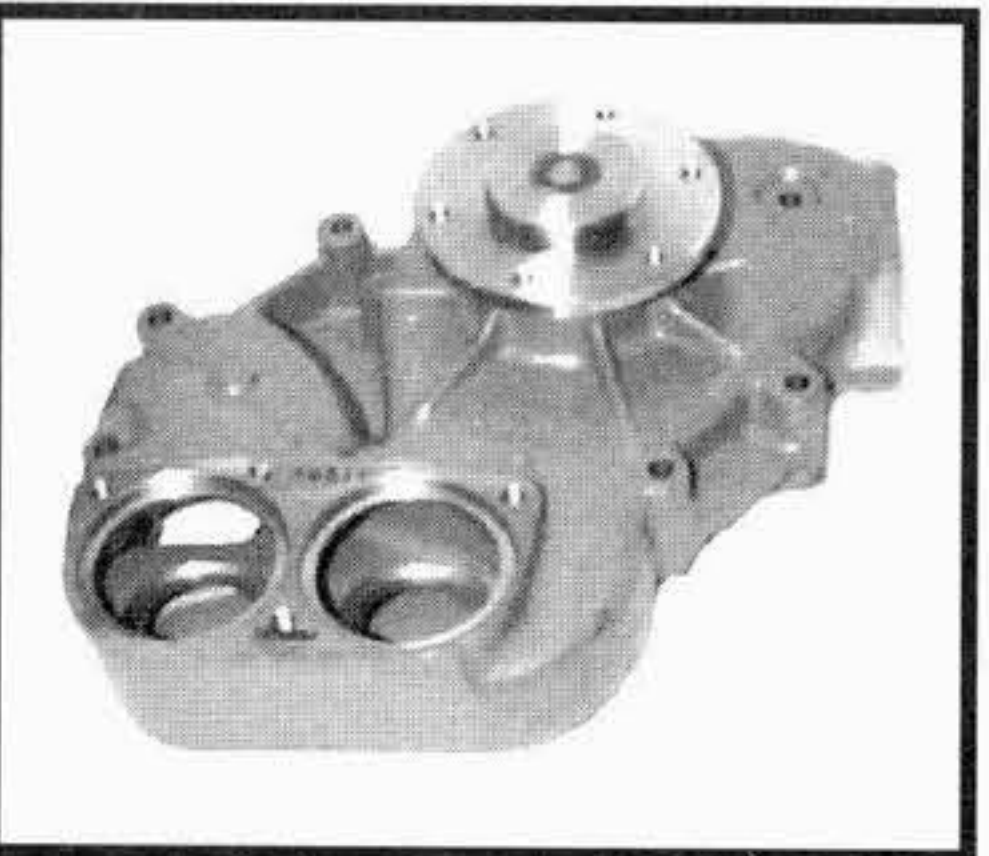
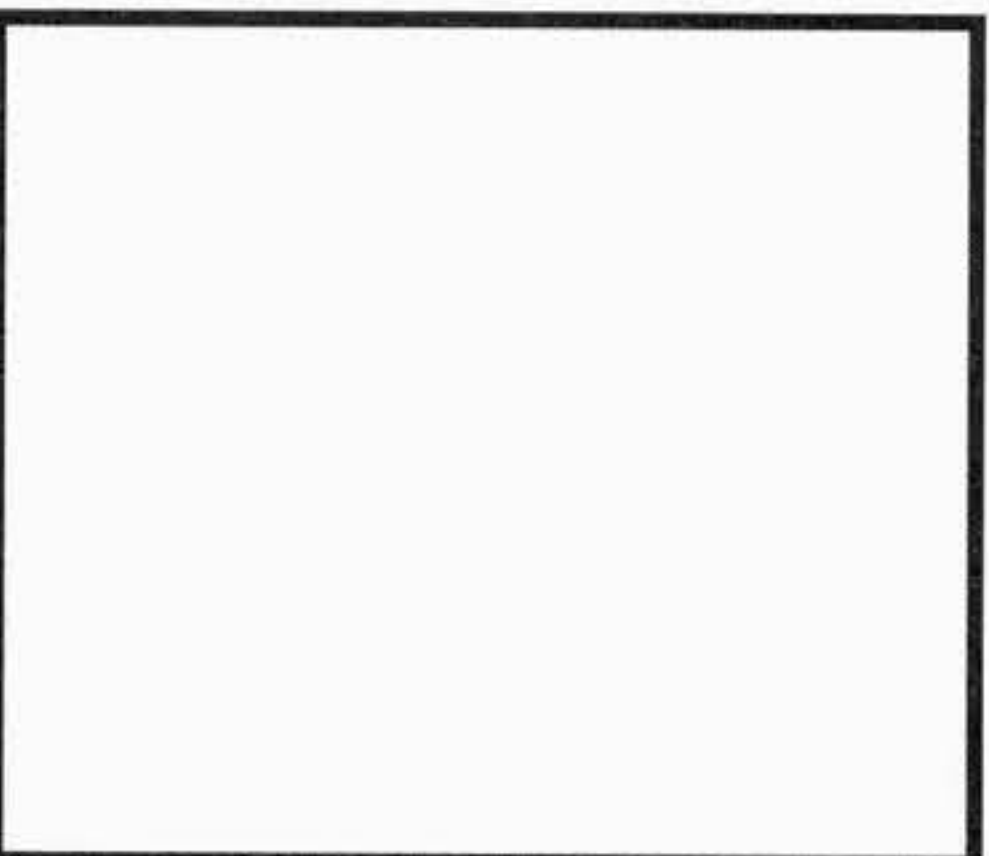
TIPO O MODELLO TYPE OU MODELE TYPE OR MODEL	MOTORE MOTEUR ENGINE	POMPA ACQUA POMPE A EAU WATER PUMP	KIT RIPARAZIONE NECESSAIRE DE REP. REPAIR KIT
R 310 - R 330 1984 ---> R 340 - R 365 1984 ---> CBH 280 - CBH 340 CLM 280 - CLM 340 AE 380 - AE 420 R 385 MAJOR - 385 TI R 420 MAJOR - 420 TI " R " 1990 ---> 1992 CBH 320 - CBH 385 CLM 320 - CLM 385 " R " 1993 --->	MD 06.35.40 MDS 06.35.40 MIDS 06.35.40 MDR 06.35.40 MIDR 06.35.40 MDR 06.35.40A	273.345 50.10.323.187 	272.219 --- 
SM 200 - SM 240 SM 200 M - SM 240 M SM 32.240 SM 260	D 2156 HMN D 2356 HMN 5 D 2156 HMN 6DR D 2356 HMN 5	- 50.00.270.928 con basamento / with housing  273.035 50.00.336.332 senza basamento / without housing	272.101 50.00.270.327  273.003 50.00.815.826 albero completo / complete shaft
C 210 - 19 G 210.17 - G 210.19 G 230.17 - G 230.19 CLR 220 C 260.19 C 260.19T (4 x 4) C 260.26 (6 x 4) G 260.11 - G 260.13 - G 260.15 G 260.16 - G 260.17 - G 260.19 G 260.26 - G 260.15T G 260.17 T - G 260.17TD G 260.19T C 290 - G 290	MIDS 06.20.30 MIDS 06.20.45 MIDS 06.20.45 MIDR 06.20.45	273.300 50.00.663.121 	
GR 251 - TR 251 - PS 30 - HI 38	D 2566 MTSF	273.230 50.00.281.838  note : girante / impeller Ø 125 mm	272.162 50.00.282.215 

I ricambi non sono originali ma adattabili . Ogni riferimento originale é assolutamente indicativo .
 Spare parts are not original but perfectly suitable . Every original part number has to be considered for reference purpose only .

SUITABLE

RVI







RENAULT V.I.

AUTOCARRI

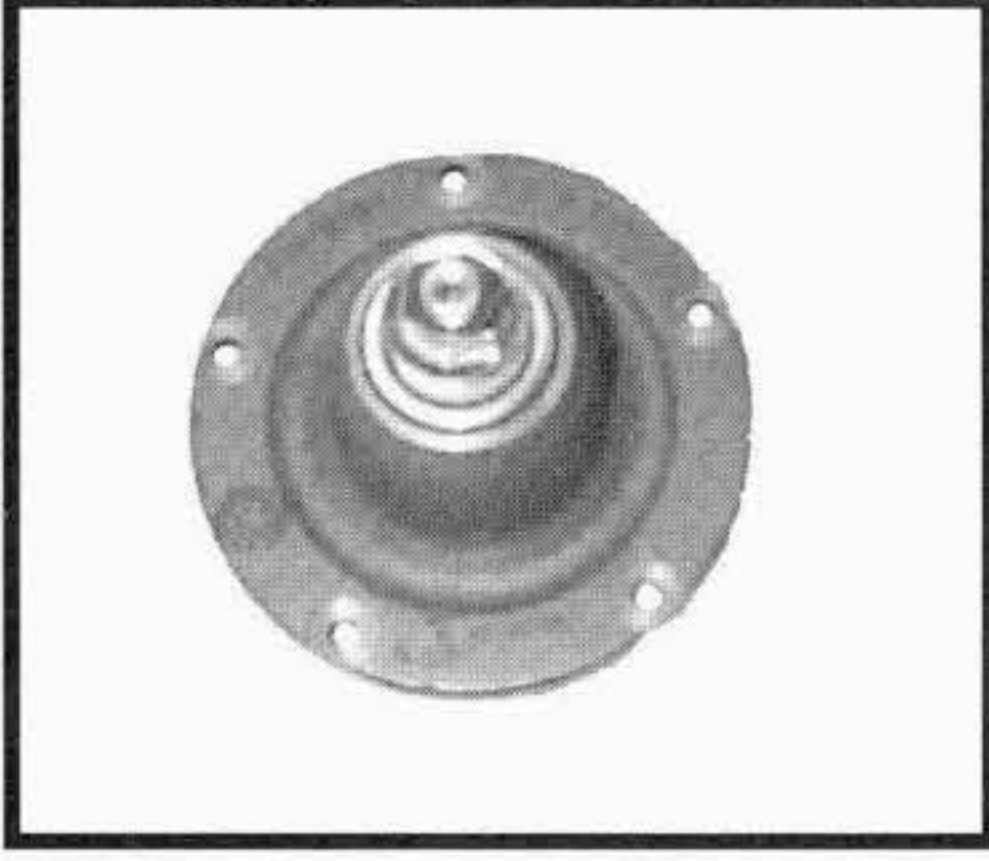
Tel:+44(0)1925 850082 Fax: +(0)44 1925 850083

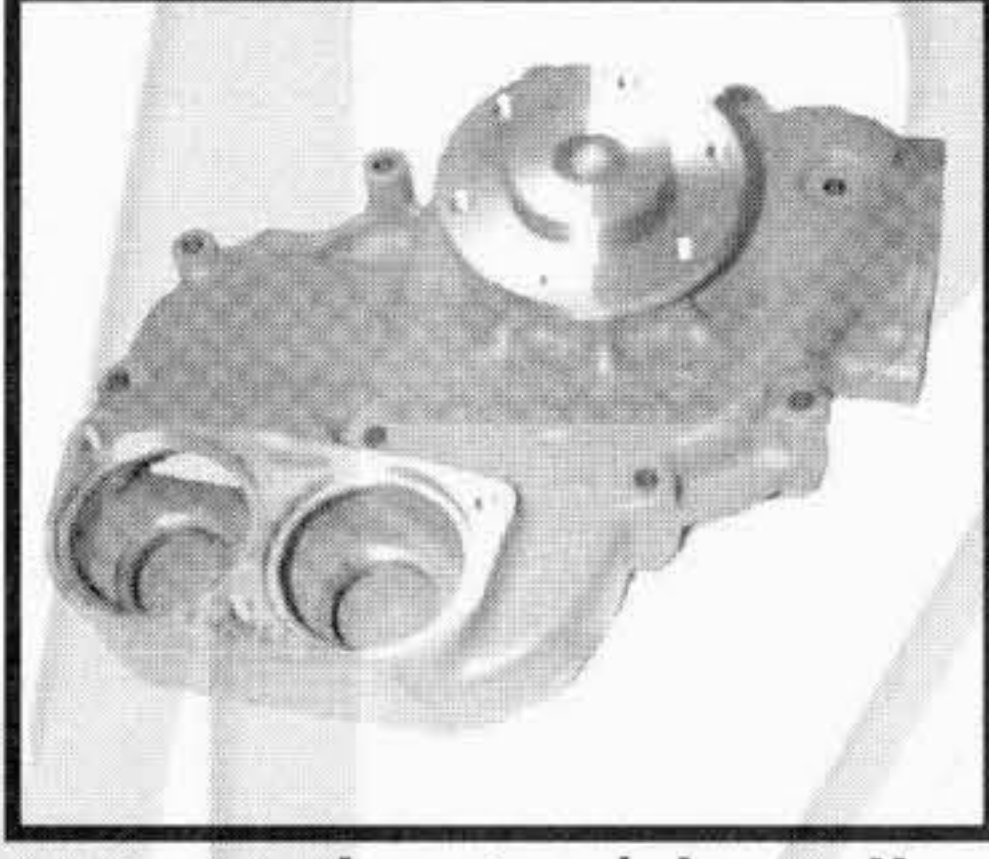
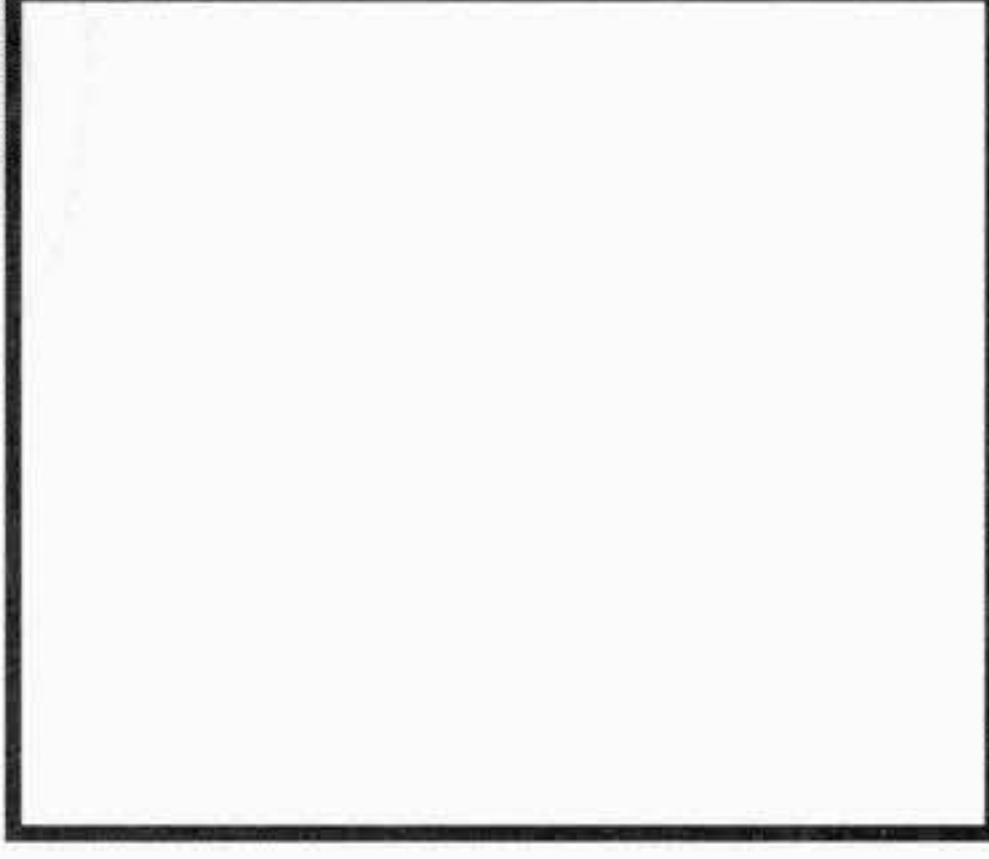
www.spwaterpumps.co.uk



TIPO O MODELLO TYPE OU MODELE TYPE OR MODEL	MOTORE MOTEUR ENGINE	POMPA ACQUA POMPE A EAU WATER PUMP OMP REF. / O.EM. REF	KIT RIPARAZIONE NECESSAIRE DE REP. REPAIR KIT OMP REF. / O.EM. REF
SM 280 SM 280TU - SM 280 TU / VT SM 36.280 TU - SM 38.280 TU	D 2156 MTN 5	- 50.00.279.907 con basamento / with housing  273.040 50.00.336.333 senza basamento / without housing	272.101 50.00.270.327  273.032 50.00.815.827 albero completo / complete shaft
TUTTI I MODELLI CON IL MOTORE ALL MODELS WITH ENGINE	D 2566 D 2530 D 2538	273.260 50.00.286.186  note : girante / impeller Ø 125 mm	272.162 50.00.282.215 
TR 300 GR 320 - TR 320 - TRH 320 GR 350 / PX 40T - TR 350 / PX 40T GRH 350 (6 X 4) / PX 40V TRH 350 (6 X 4) / PX 40T R 360 - R 360 T R 360 (6 X 4) - R 360 T (6 X 4) R 370 (4 X 2) - R 370 T (4 X 2) R 370 (6 X 4) - R 370 T/TS (6X4)	V 835 V 835 - MIV 08.35.30 A/BC MIVS 08.35.30 MIVS 08.35.30 MIVS 08.35.30	273.315 00.00.158.206 	
770 KB 6 FPT 15.05.81 ---> 770 KB 6 EAP 30	MID 06.20.30	273.310 00.00.157.274 	

I ricambi non sono originali ma adattabili . Ogni riferimento originale é assolutamente indicativo .
 Spare parts are not original but perfectly suitable . Every original part number has to be considered for reference purpose only .

SUITABLE



RVI

RENAULT V.I. AUTOCARRI

Tel:+44(0)1925 850082 Fax: +(0)44 1925 850083

www.spwaterpumps.co.uk

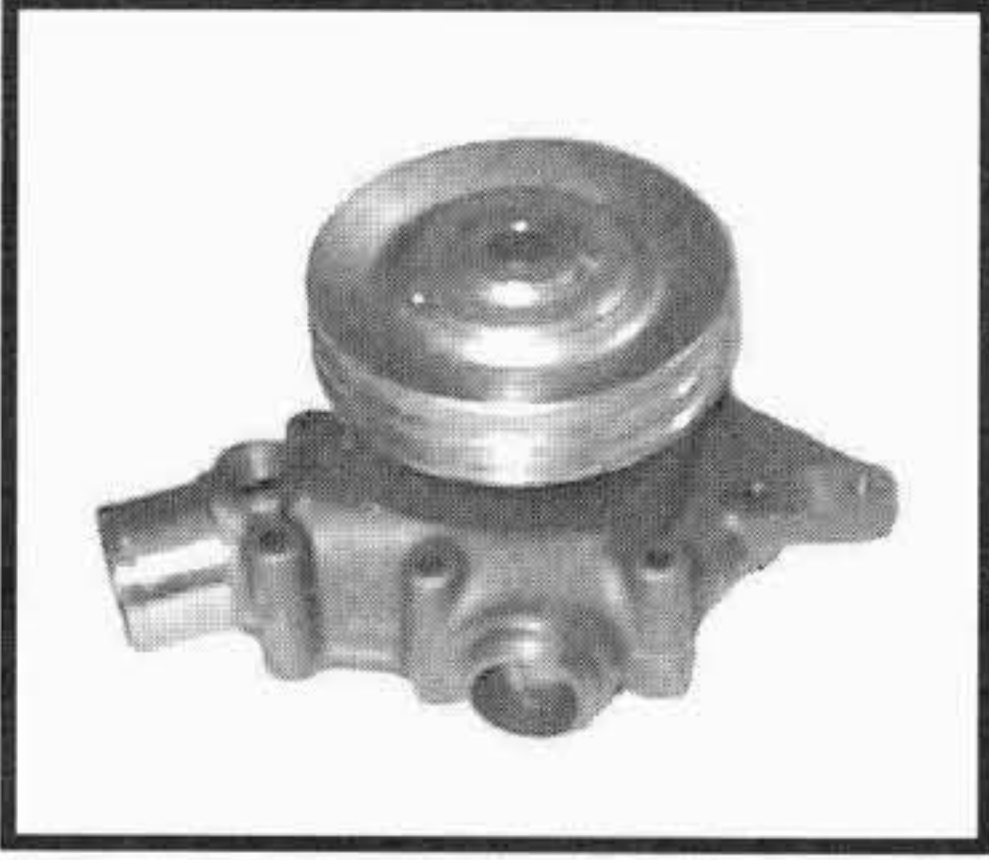
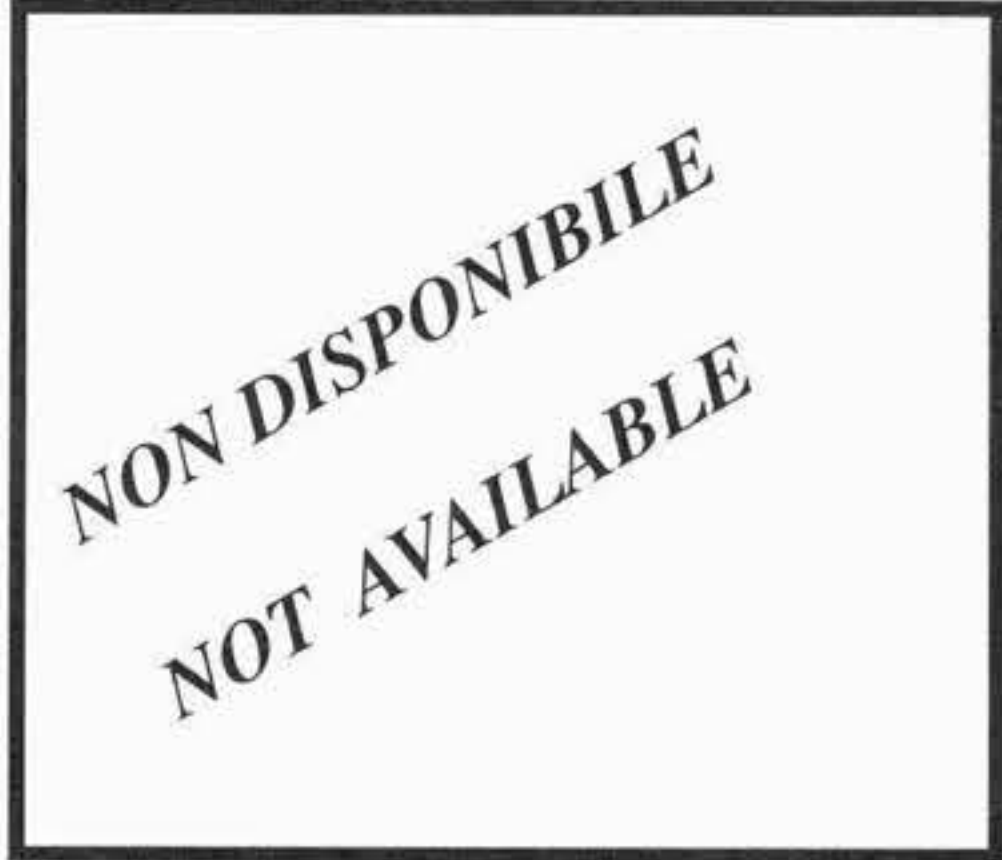
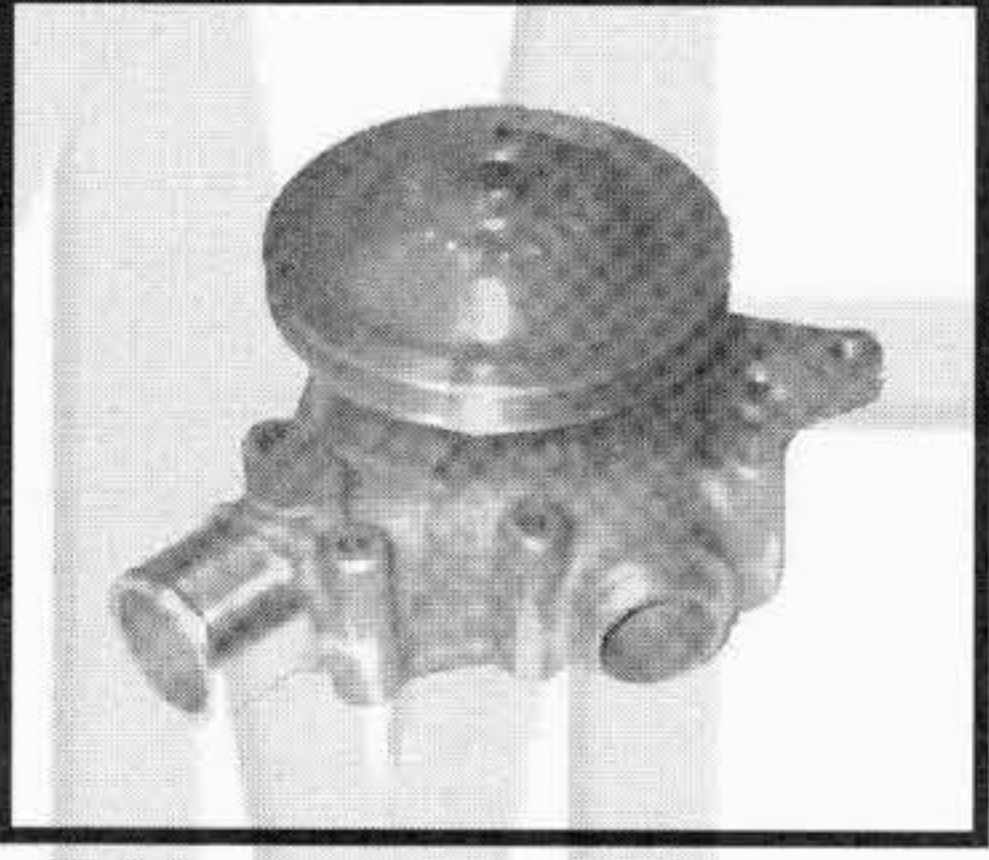
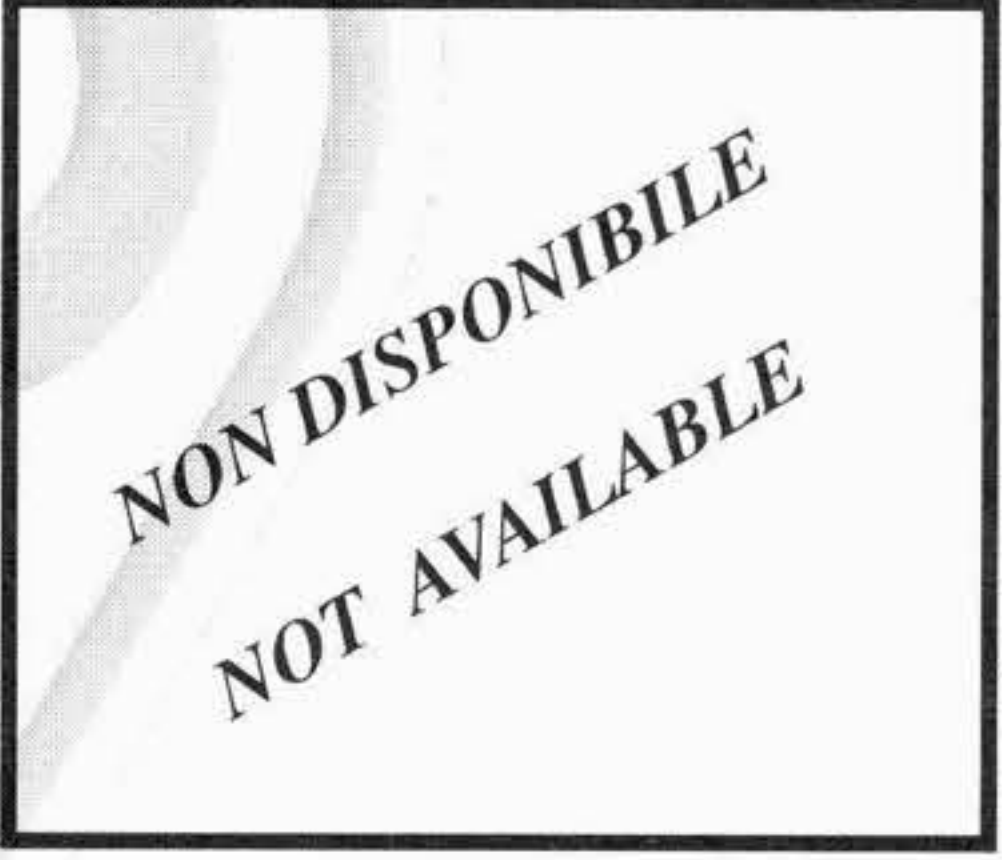
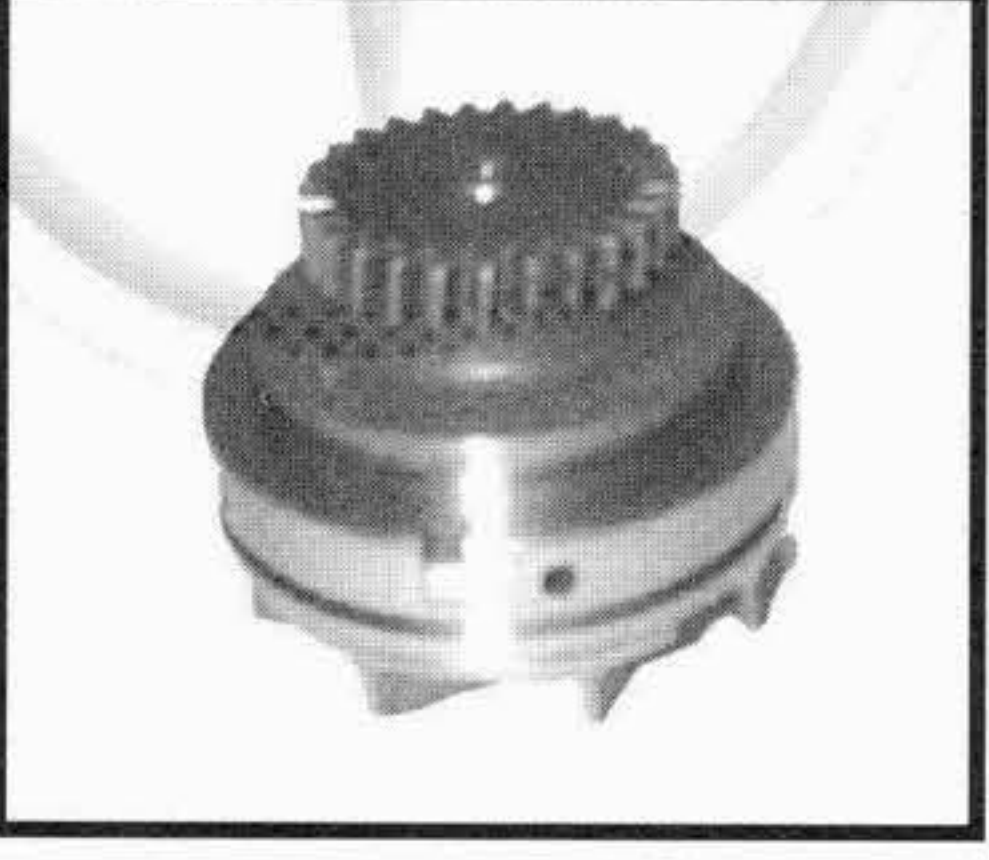
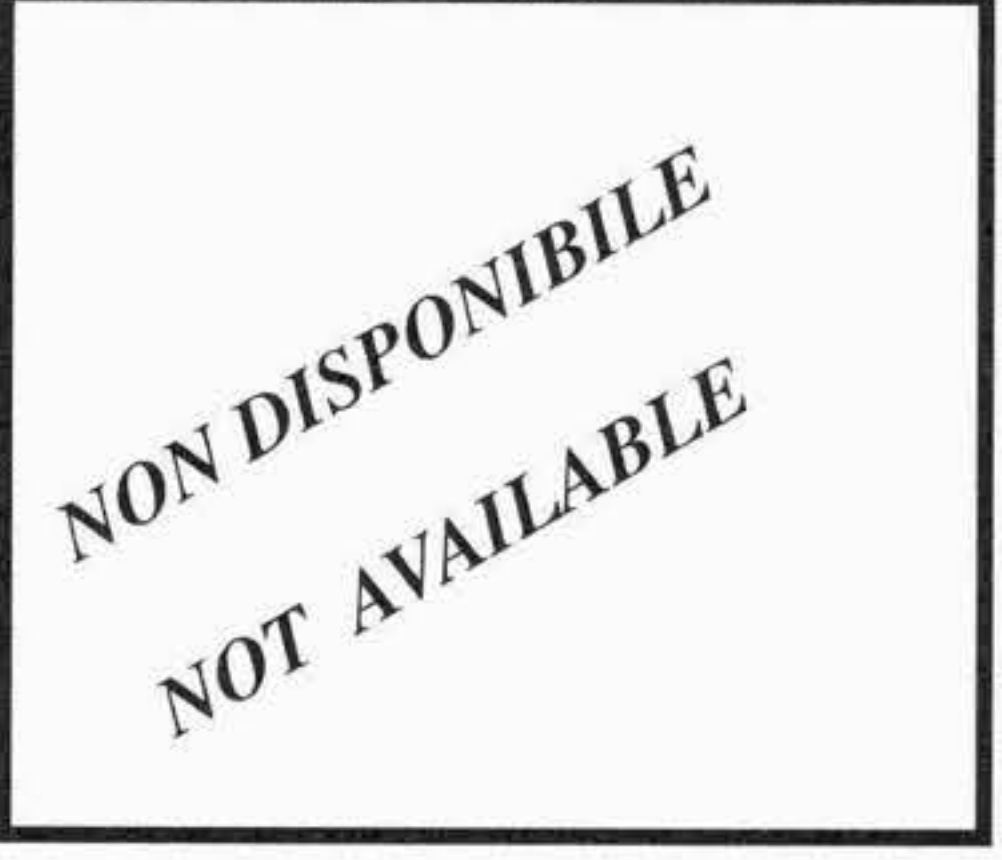

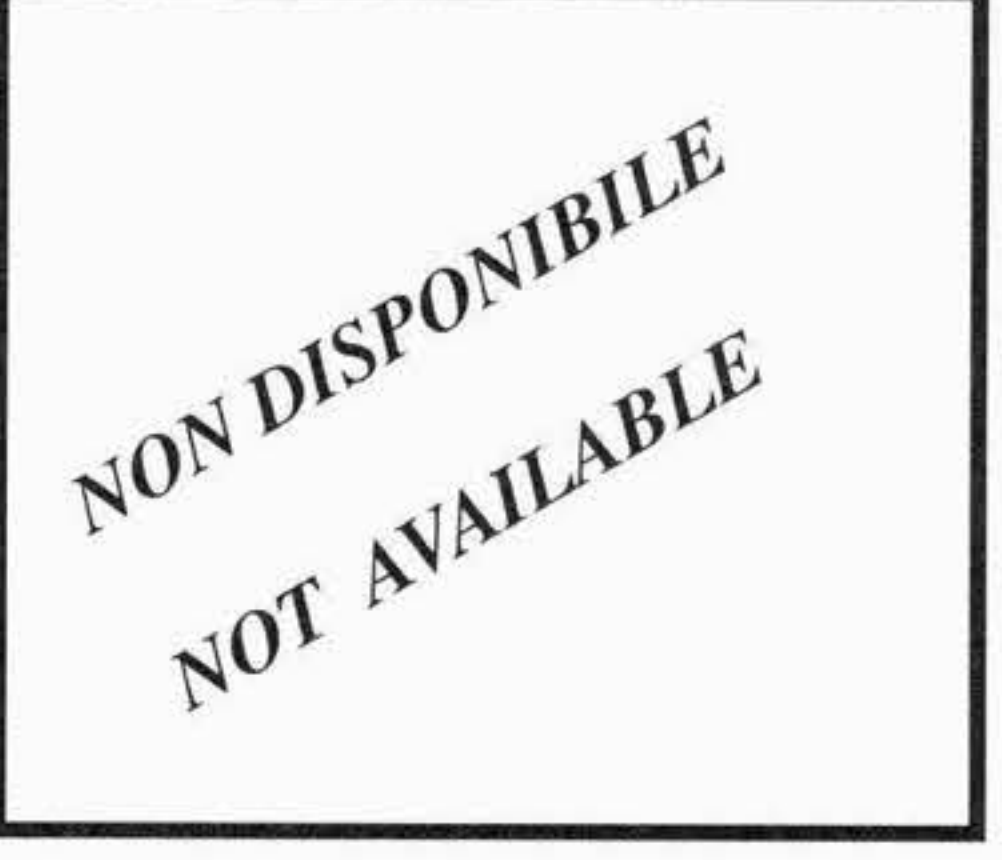
TIPO O MODELLO TYPE OU MODELE TYPE OR MODEL	MOTORE MOTEUR ENGINE	POMPA ACQUA POMPE A EAU WATER PUMP OMP REF. / O.EM. REF	KIT RIPARAZIONE NECESSAIRE DE REP. REPAIR KIT OMP REF. / O.EM. REF
M 140 - M 160 - M 200 - M 230 S 140 - S 160 ---> 03.91 PS 150 - PS 160 S 170 " MIDLINER " MIDLUM PUNCHER Serie C Serie G	MIDR 06.20.45B MIDS 06.20.45B	273.350 50.10.258.977 	
M 140 - M 160 - M 200 - M 230 S 140 - S 160 04.92 ---> PS 150 - PS 160 S 170 " MIDLINER "	MIDR 06.20.45B MIDS 06.20.45B	273.370 50.10.258.978 	
C 210 - CLR 220 C 230 - C 260 - C 280 - C 290 C 300 - CCH 300 - C 340 TI G210 - G 220 - G 230 - G 270 G 260 - G 290 - R 312 - G 320 R 310 - R330 - R340 - R365 1984 --> " G " MANAGER (4 x 2 / 6 x 2 / 6 x 4) G 340 MAXTER (6 x 4 / 8 x 4) 1992 --> G 340 TI (4 x 4 / 6 x 6) - G 340 TI TR18 T " R " 1990 --->	MIDR 06.20.45 MIDR 06.20.45 E/3	273.130 50.00.670.157 	
C 230 - C 280 C 300 - CCH 300 - C 340 TI G 220 - G 270 G 300 GT MANAGER G 340 MANAGER G 340 MAXTER (6 x 4 / 8 x 4) 1992 ---> G 340 TI (4 x 4 / 6 x 6) G 340 TI TR 18 T	MIDR 06.20.45 MIDR 06.20.45 E/3	273.340 50.00.681.283 	

I ricambi non sono originali ma adattabili . Ogni riferimento originale é assolutamente indicativo .
 Spare parts are not original but perfectly suitable . Every original part number has to be considered for reference purpose only .

SUITABLE

RVI

RENAULT V.I. AUTOCARRI



Tel:+44(0)1925 850082 Fax: +(0)44 1925 850083

www.spwaterpumps.co.uk

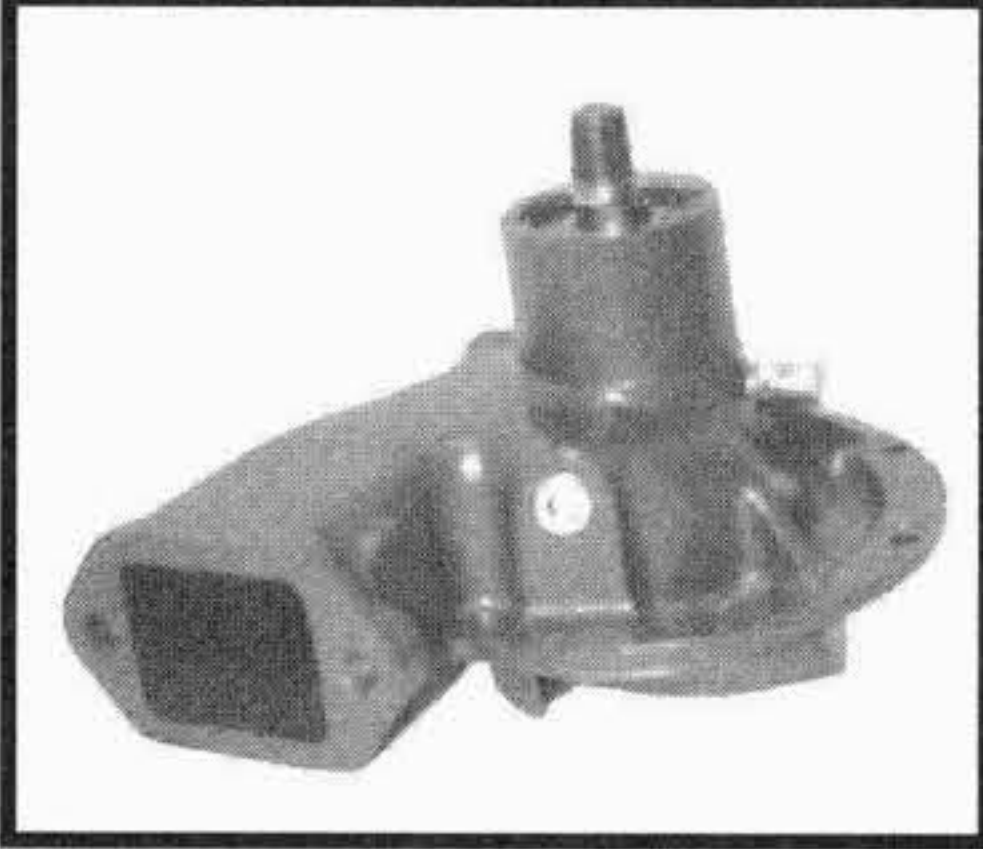
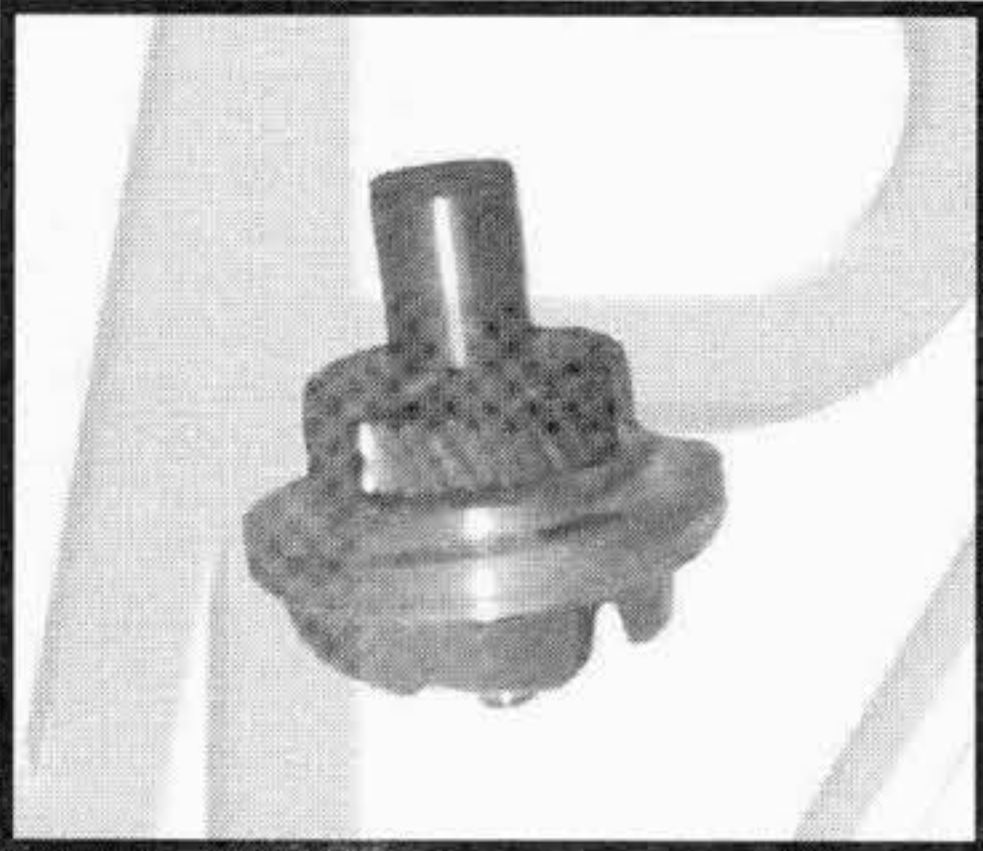
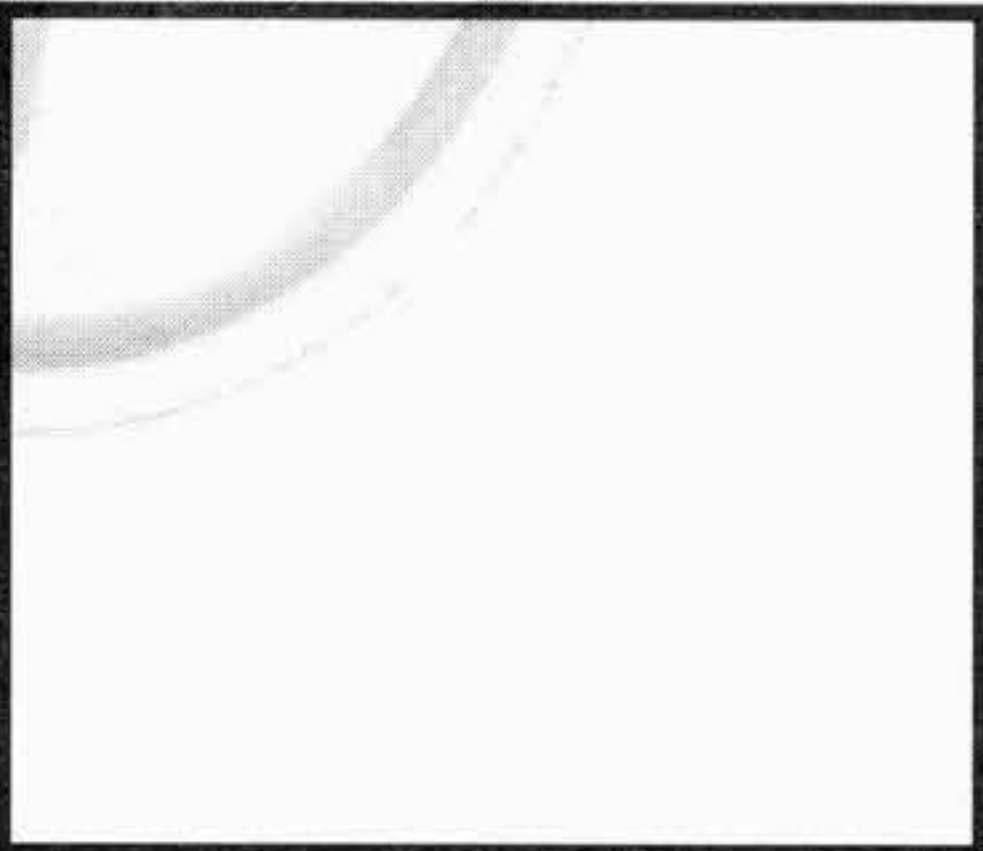
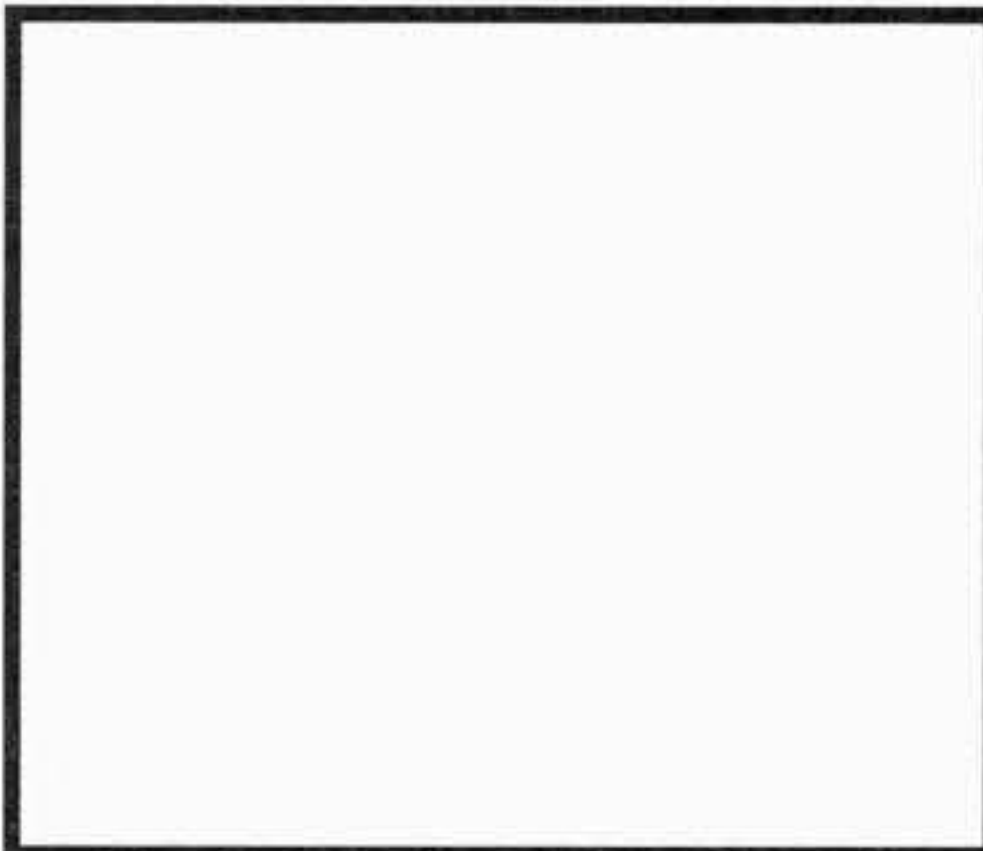
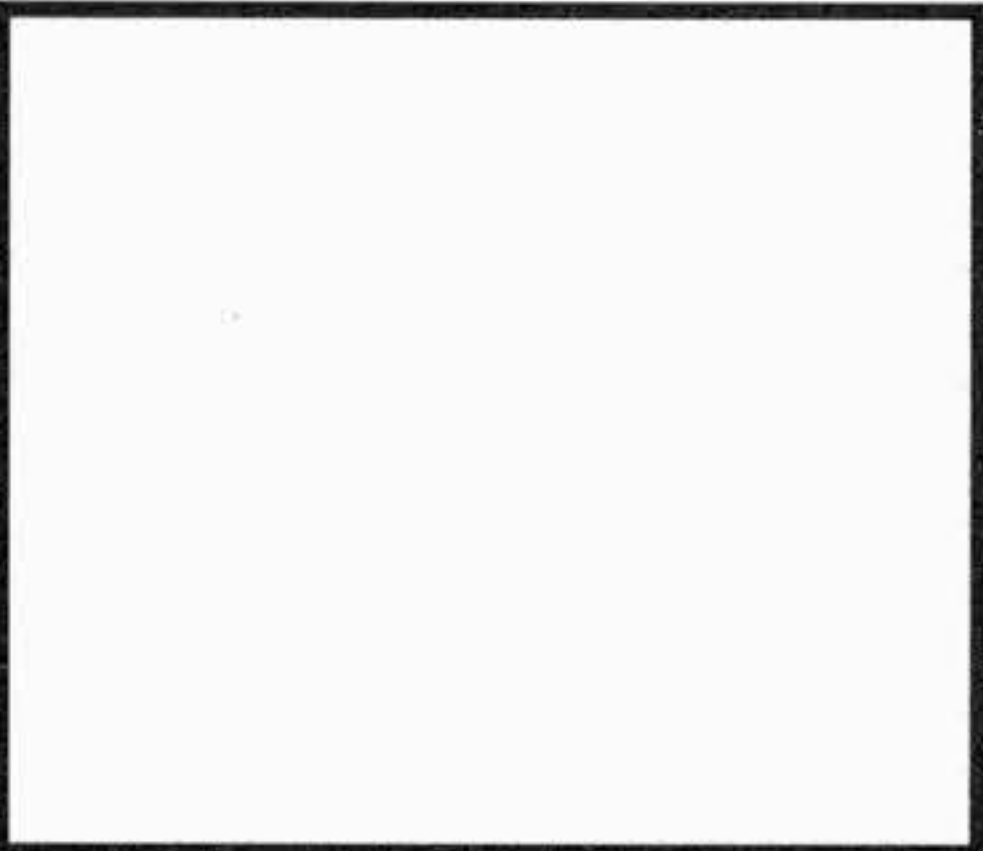
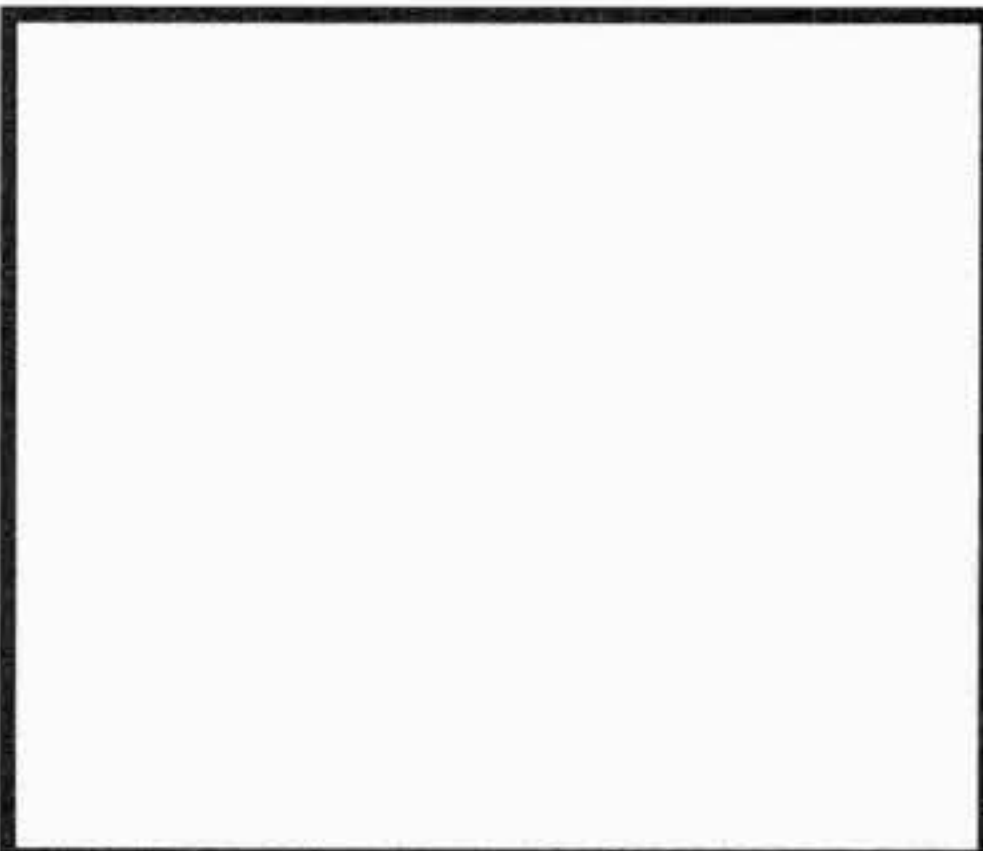

TIPO O MODELLO TYPE OU MODELE TYPE OR MODEL	MOTORE MOTEUR ENGINE	POMPA ACQUA POMPE A EAU WATER PUMP	KIT RIPARAZIONE NECESSAIRE DE REP. REPAIR KIT
MAGNUM '97 AE 390 AE 430 AE470	MIDR 06.35.40 6 CYL. - 12 L.	<p>279.020 -</p>  <p>- 50.10.284.179 con basamento e puleggia with housing & pulley</p>	<p>NON DISPONIBILE NOT AVAILABLE</p>
AE 500 AE 520	E9 - 502 8 V E9 - 530	<p>273.355 50.00.823.146</p> 	<p>NON DISPONIBILE NOT AVAILABLE</p>
			
			

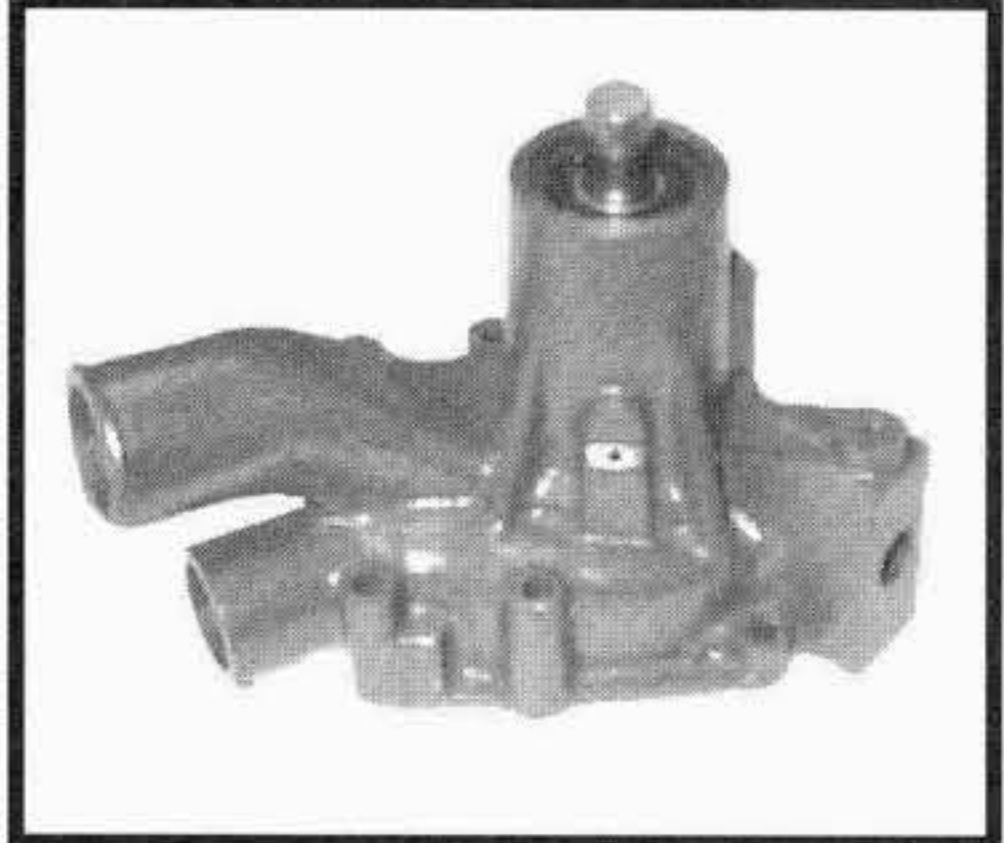
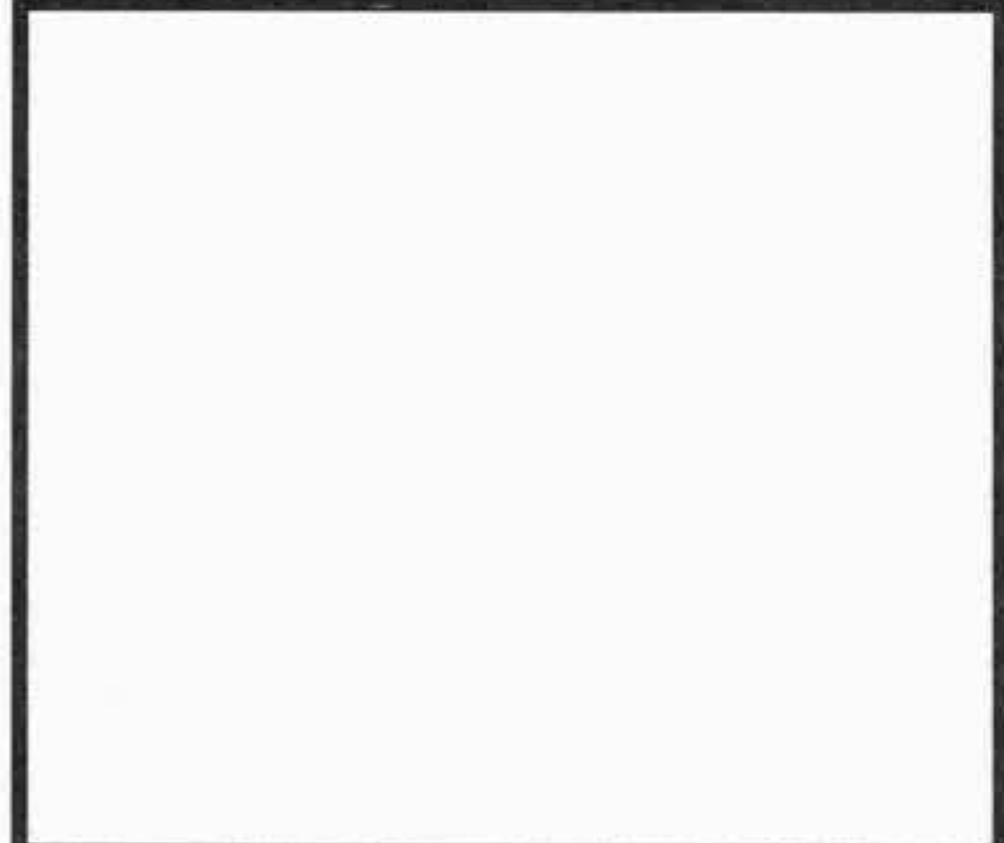
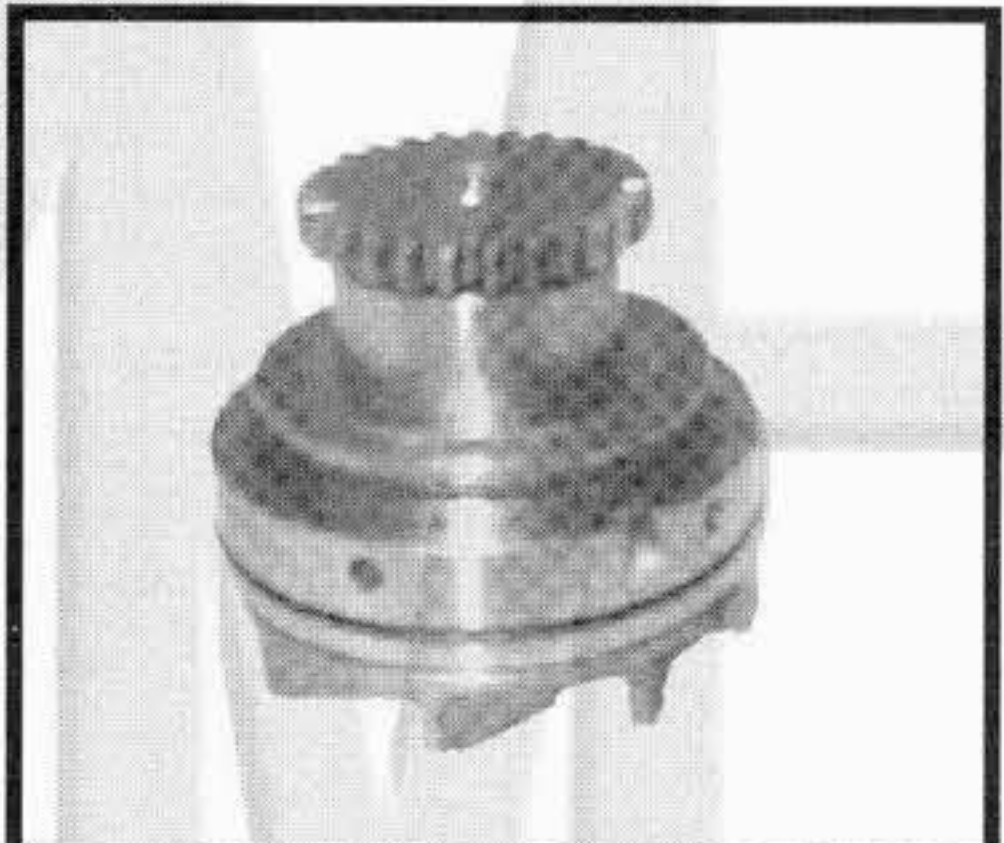
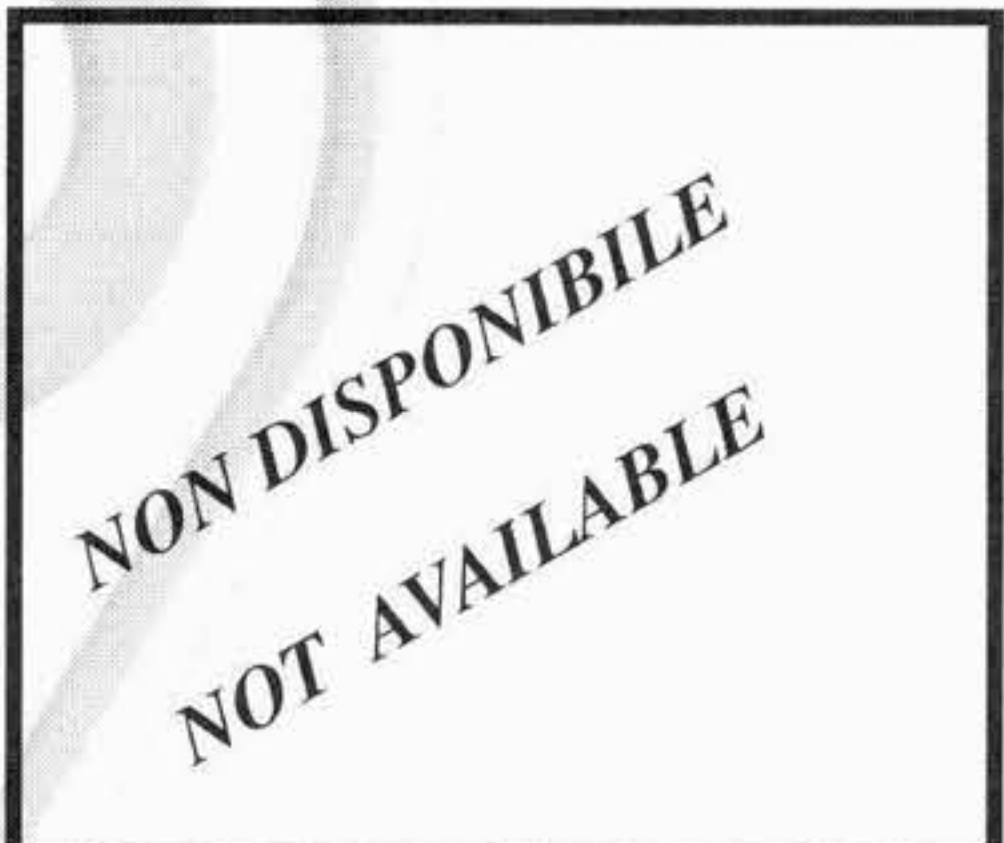
I ricambi non sono originali ma adattabili . Ogni riferimento originale é assolutamente indicativo .
Spare parts are not original but perfectly suitable . Every original part number has to be considered for reference purpose only .

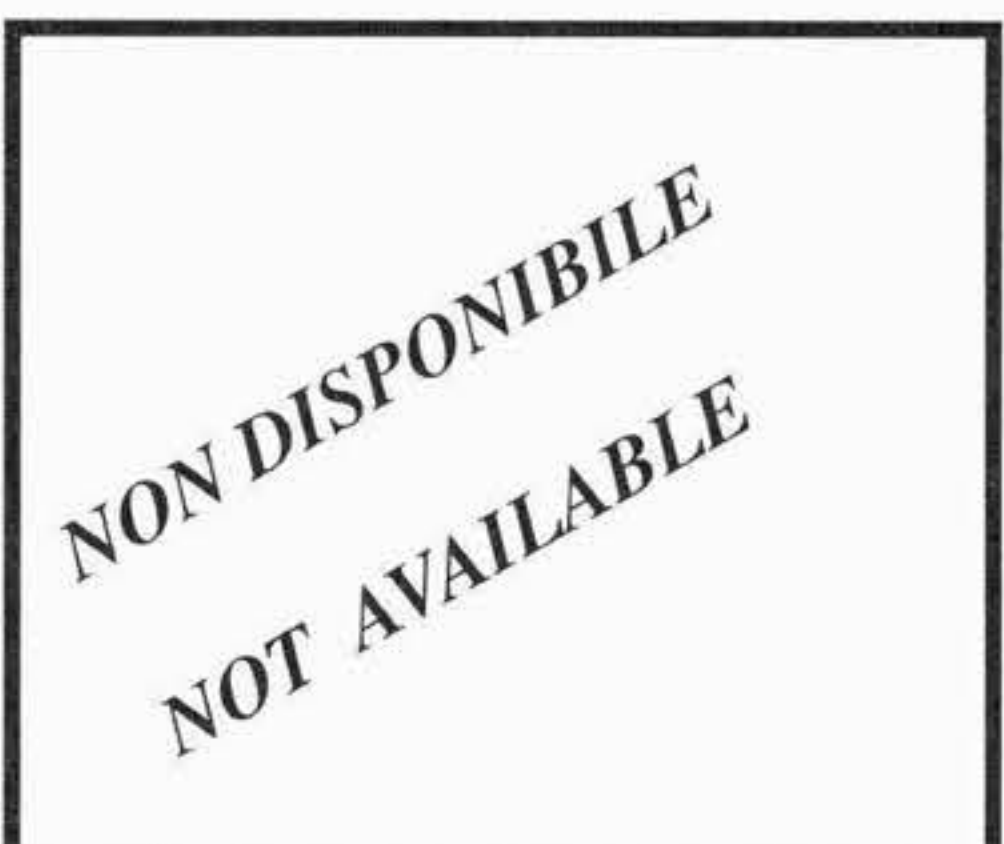
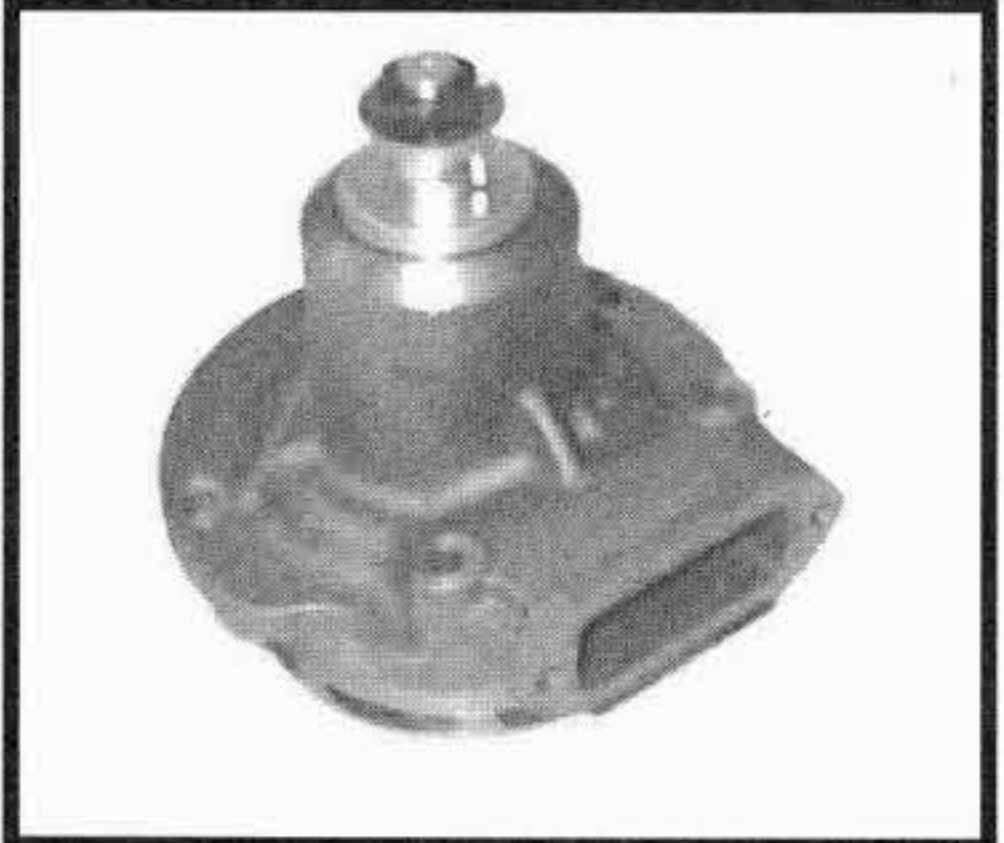
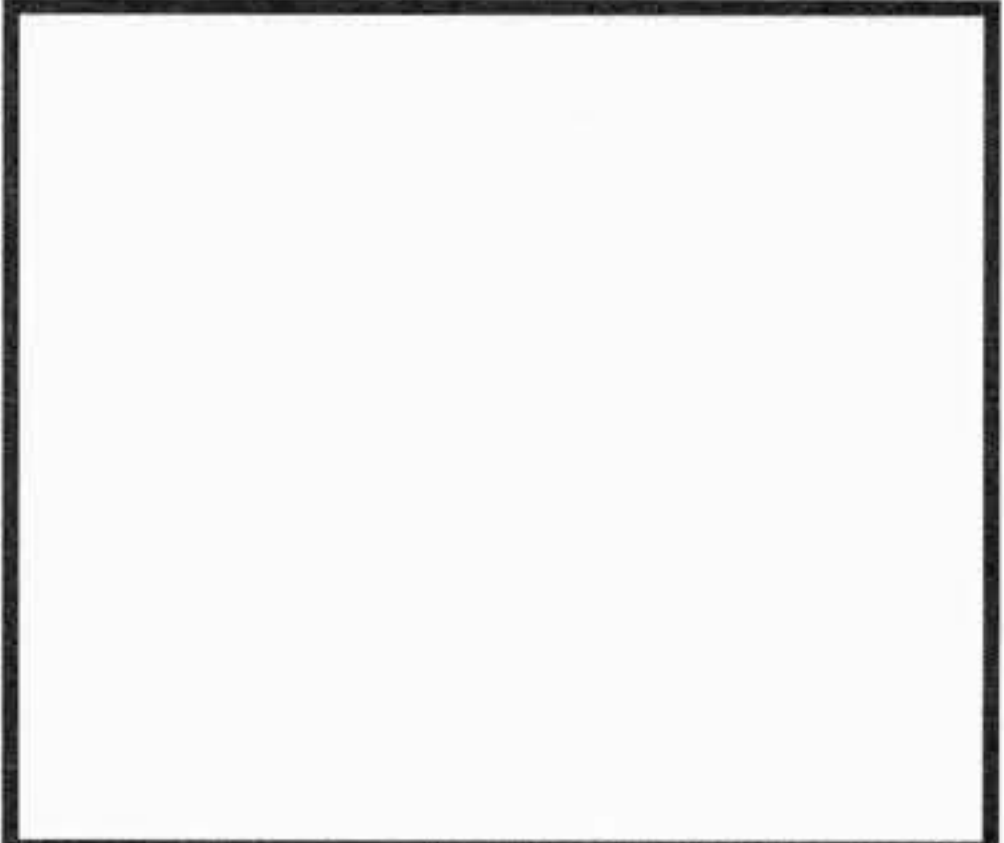
TIPO O MODELLO TYPE OU MODELE TYPE OR MODEL	MOTORE MOTEUR ENGINE	POMPA ACQUA POMPE A EAU WATER PUMP OMP REF. / O.E.M. REF	KIT RIPARAZIONE NECESSAIRE DE REP. REPAIR KIT OMP REF. / O.E.M. REF
E 7 C SC 29 SC 50	798.40 797.50	273.100 50.00.338.059 	272.174 50.00.338.060 
PR 10 S PR 12 S 15.05.81 --> 31.05.85 PR 14 S / 640 PR 14 S / 641 PG 60 - G 45 - G 105 PG 60 S - G 45 S - G 105 S PR 100 MI 15.05.81 --> 30.06.83 PR 180 15.05.81 --> 30.06.83	MIDS 06.20.30 MIDS 06.20.30 MIDS 06.20.30 MIP 06.20.30 MIPS 06.20.30	273.110 50.00.663.009 	
FR 1 --> 1985 PR 14 SR PR 14 SL --> 30.11.84 PR 100 MI 01.07.83 --> PR 180 01.07.83 -->	MIDR 06.20.45 MIDR 06.20.30 MIP 06.20.30 MIPS 06.20.30	273.300 50.00.663.121 	
E7L - E7M - E7N	D 2156 - D 2356	273.070 50.00.336.331 senza basamento / without housing  --- 50.00.273.791 con basamento / with housing	272.110 50.00.273.543  273.075 50.00.815.829 albero completo / complete shaft

I ricambi non sono originali ma adattabili . Ogni riferimento originale é assolutamente indicativo .
Spare parts are not original but perfectly suitable . Every original part number has to be considered for reference purpose only .

SUITABLE

RVI





RENAULT V.I.

AUTOBUS

Tel:+44(0)1925 850082 Fax: +(0)44 1925 850083

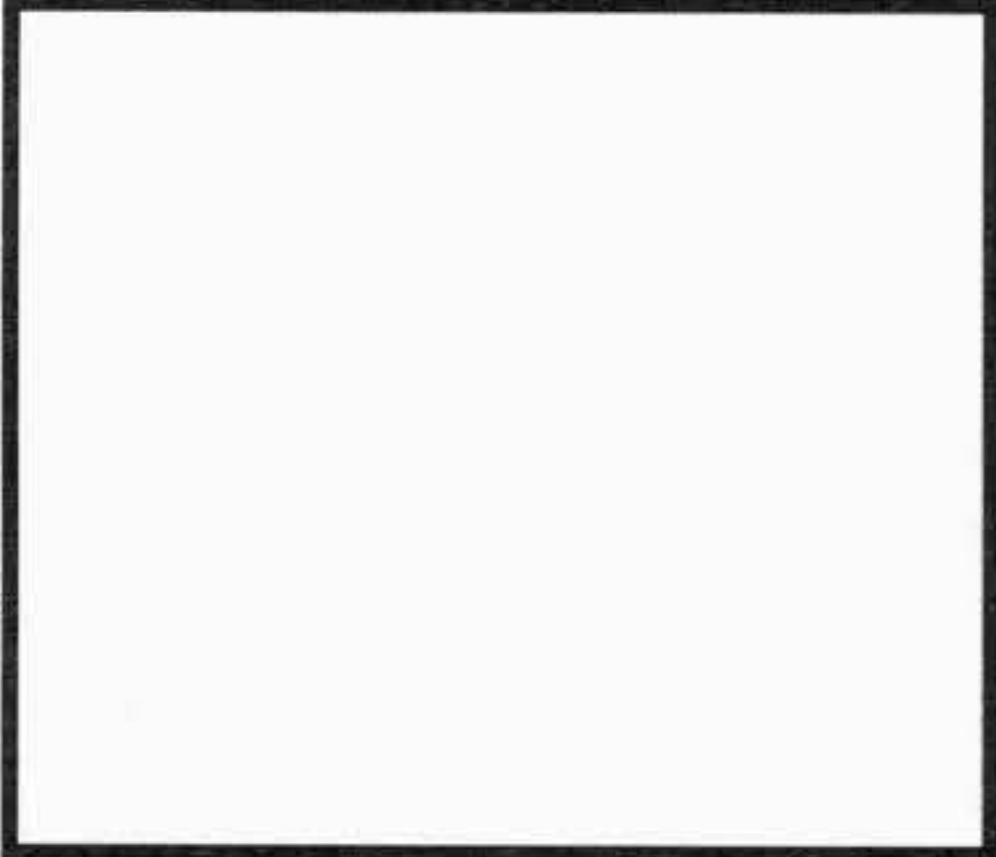
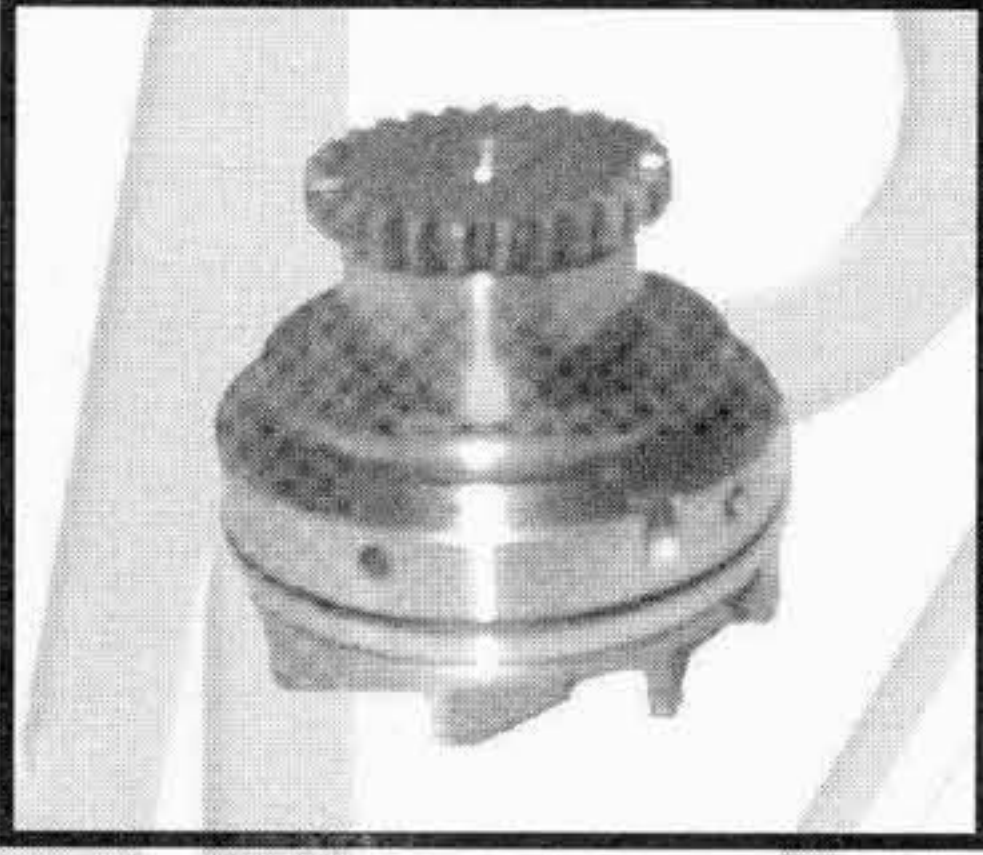
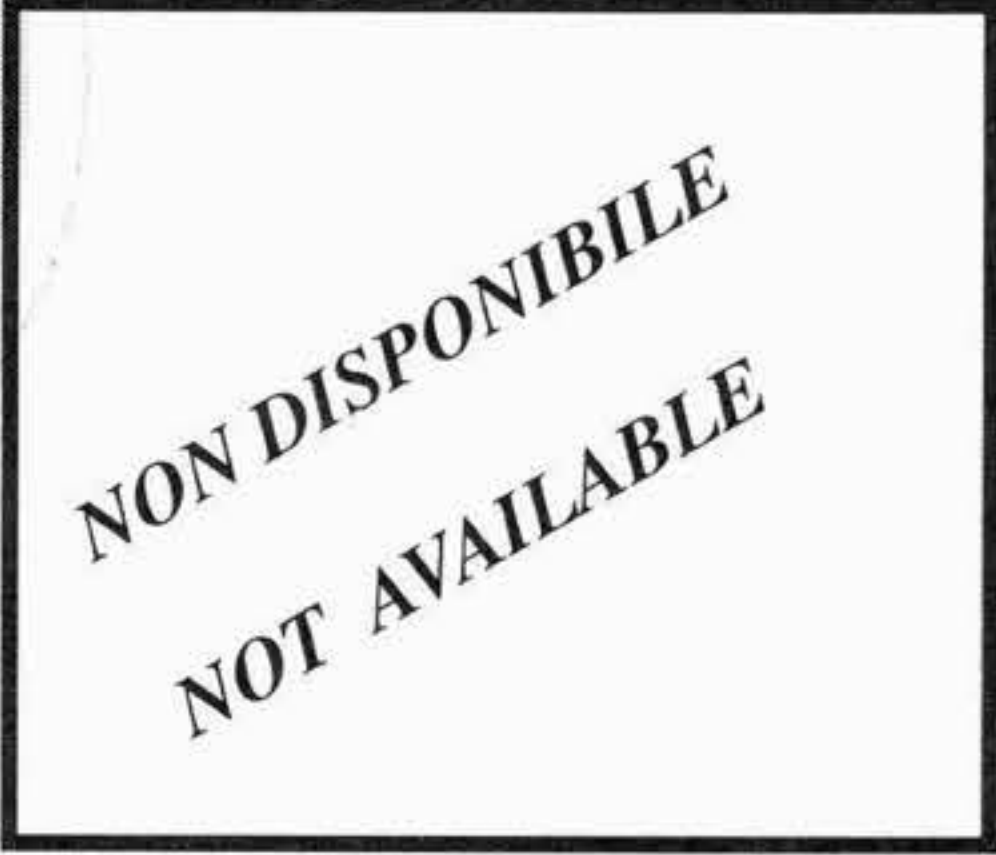
www.spwaterpumps.co.uk

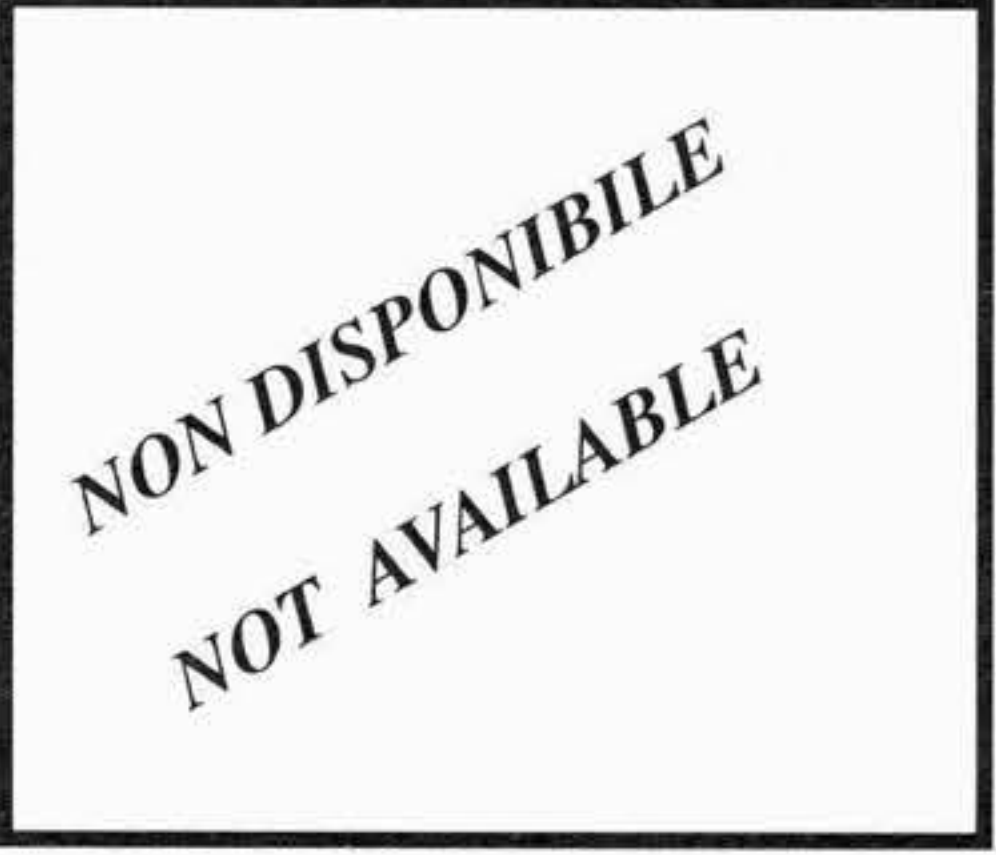

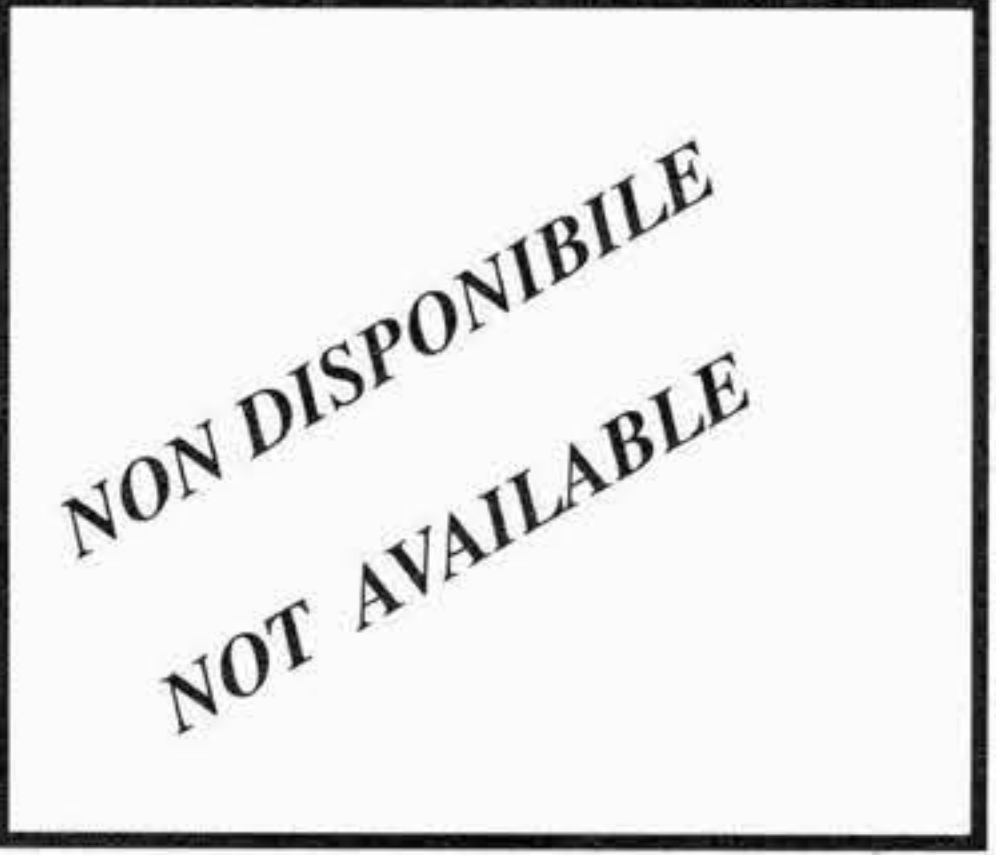
TIPO O MODELLO TYPE OU MODELE TYPE OR MODEL	MOTORE MOTEUR ENGINE	POMPA ACQUA POMPE A EAU WATER PUMP OMP REF. / O.EM. REF	KIT RIPARAZIONE NECESSAIRE DE REP. REPAIR KIT OMP REF. / O.EM. REF
E 7 L - S 57 Type 971 E 7 M - S 57 Type 977 E 7 N - S 57 Type 981	D 2566 MSH	<p>273.230 50.00.281.838</p>  <p>note : girante / impeller Ø 125 mm</p>	<p>272.162 50.00.282.215</p> 
PR 10 S PR 12 S ---> 14.05.81 PR 14 S / 640	MIDS 06.20.30	<p>273.310 00.00.157.274</p> 	
PR 10 S PR 12 S 01.06.85 ---> PR 14 S / 640 PR 14 S / 641	MIDS 06.20.30 MIDS 06.20.30	<p>273.305 50.00.670.467</p> 	
PR 14 SR 01.12.84 ---> PR 14 SL PR 100.2 PR 180.2 FR 1 ---> 10 / 96 PR 112 - PR 118 CITYBUS AGORA	MIDR 06.20.30 MIPS 06.20.45 MIPS 06.20.45 E	<p>273.130 50.00.670.157</p> 	

I ricambi non sono originali ma adattabili . Ogni riferimento originale é assolutamente indicativo .
 Spare parts are not original but perfectly suitable . Every original part number has to be considered for reference purpose only .

SUITABLE

RVI

RENAULT V.I.

AUTOBUS

Tel:+44(0)1925 850082 Fax: +(0)44 1925 850083

www.spwaterpumps.co.uk



TIPO O MODELLO TYPE OU MODELE TYPE OR MODEL	MOTORE MOTEUR ENGINE	POMPA ACQUA POMPE A EAU WATER PUMP	KIT RIPARAZIONE NECESSAIRE DE REP. REPAIR KIT
FR 1 --> 10 / 96 PR 112 - PR 118 CITYBUS AGORA	MIPS 06.20.45 E	273.340 50.00.681.283 	
CITYBUS AGORA PREMIUM		273.360 50.10.330.029 	
SC 10 S 45 R S 53 R S 105	D 0846 HM82U D 0846 HM 42U	273.050 50.00.338.520 senza basamento / without housing  --- 50.00.277.190 con basamento / with housing	272.109 50.00.270.407  273.021 50.00.815.828 albero completo / complete shaft
TRACER	MIHS 06.20.45A MIHS 06.20.45B MIHR 06.20.45A/3 MIHR 06.20.45A/41	273.365 50.00.694.289 	

I ricambi non sono originali ma adattabili . Ogni riferimento originale é assolutamente indicativo .
 Spare parts are not original but perfectly suitable . Every original part number has to be considered for reference purpose only .

SUITABLE





RVI

RENAULT

Tel: +44(0)1925 850082 Fax: +(0)44 1925 850083

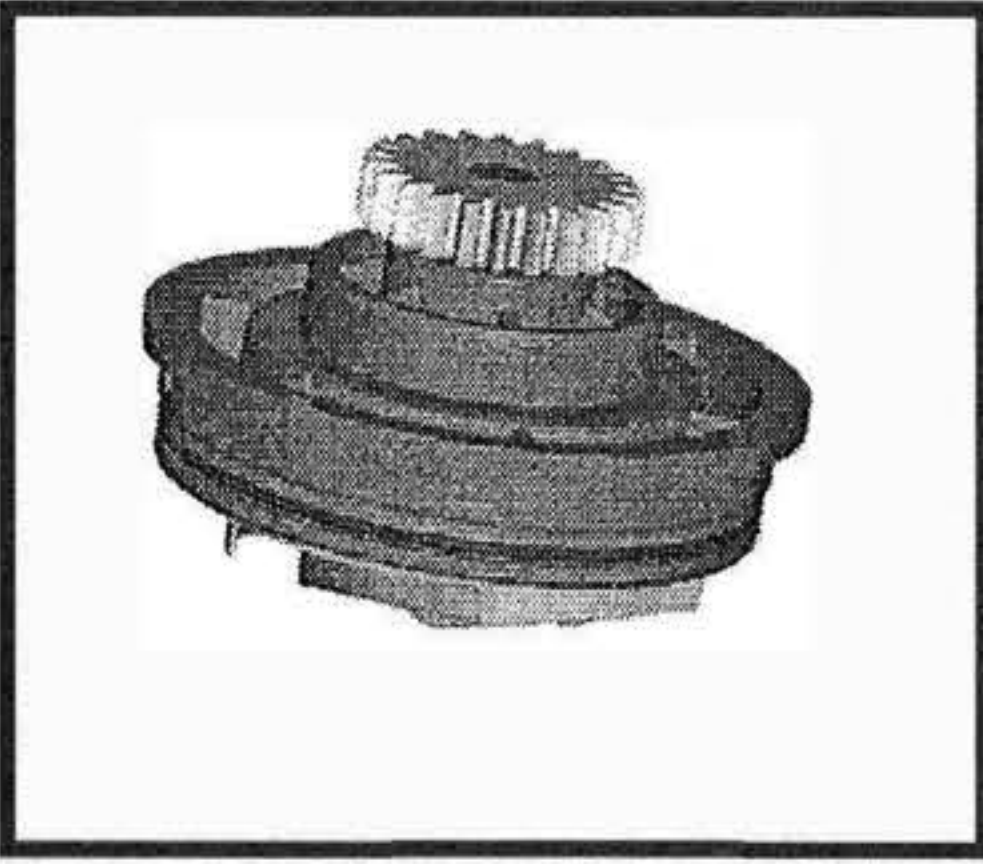
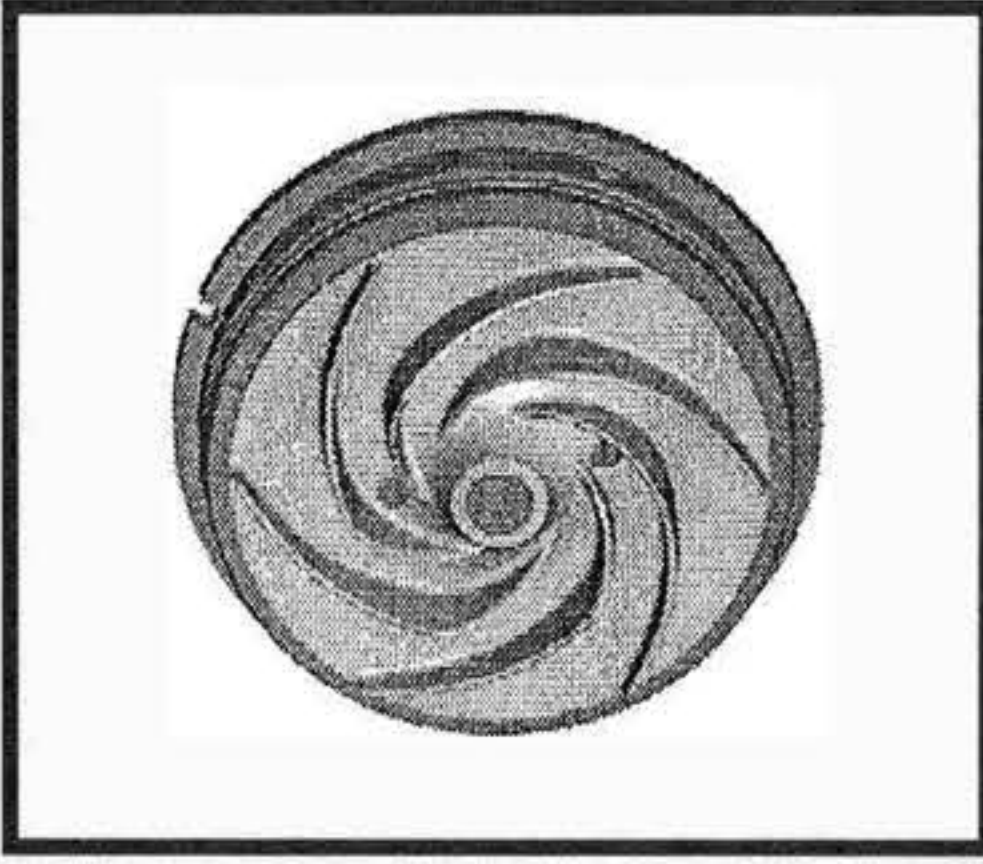
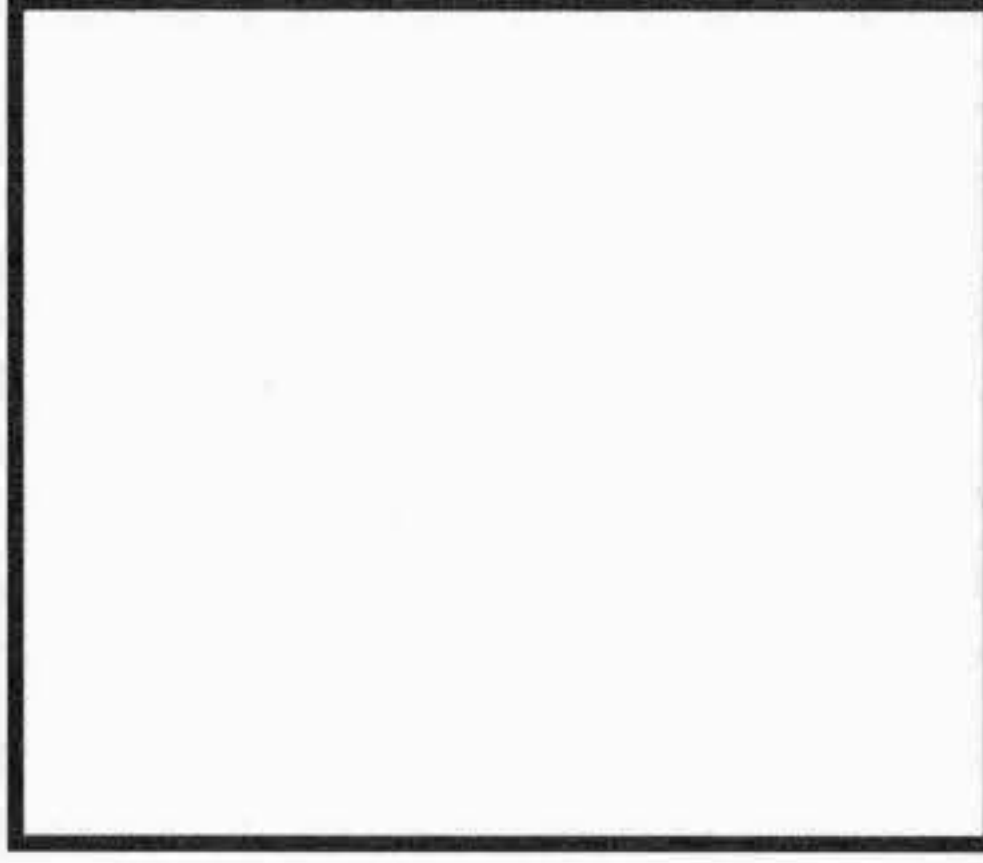
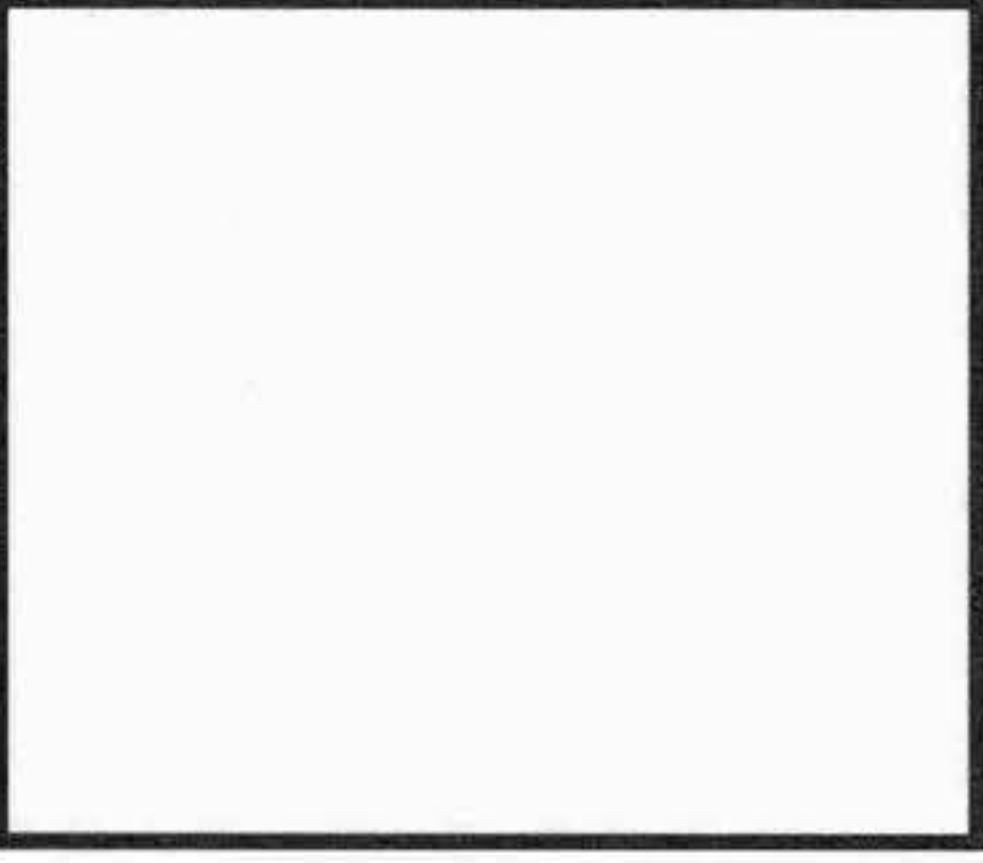
www.spwaterpumps.co.uk

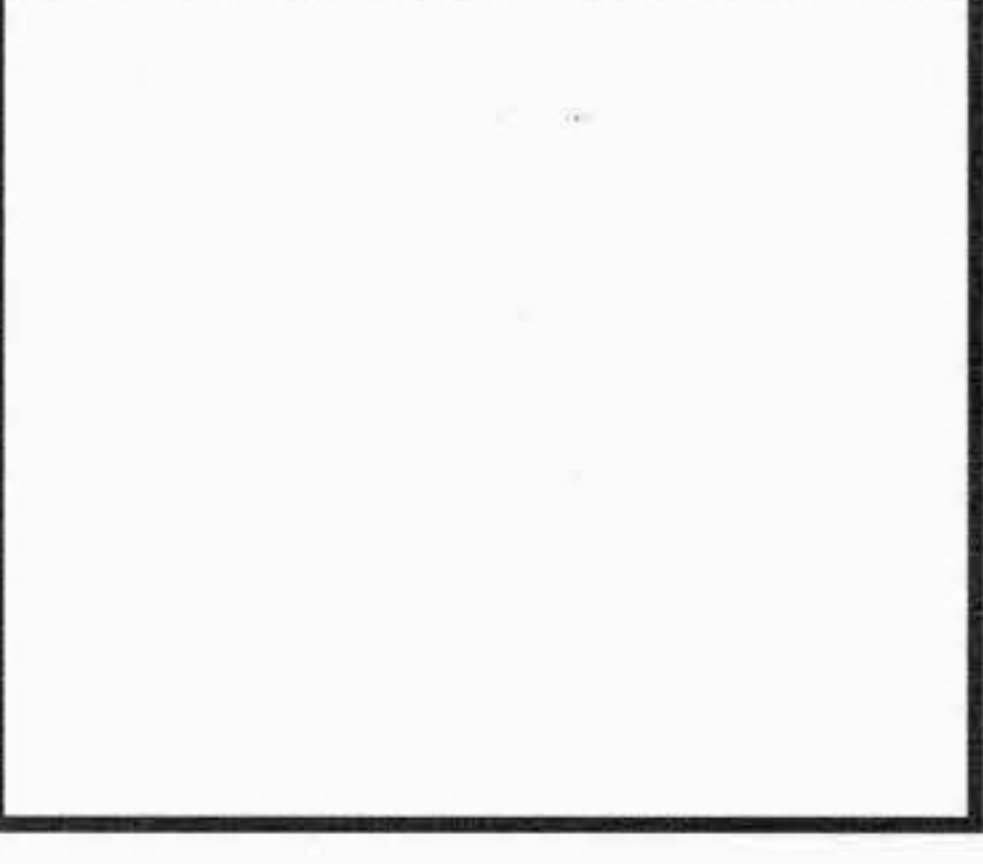
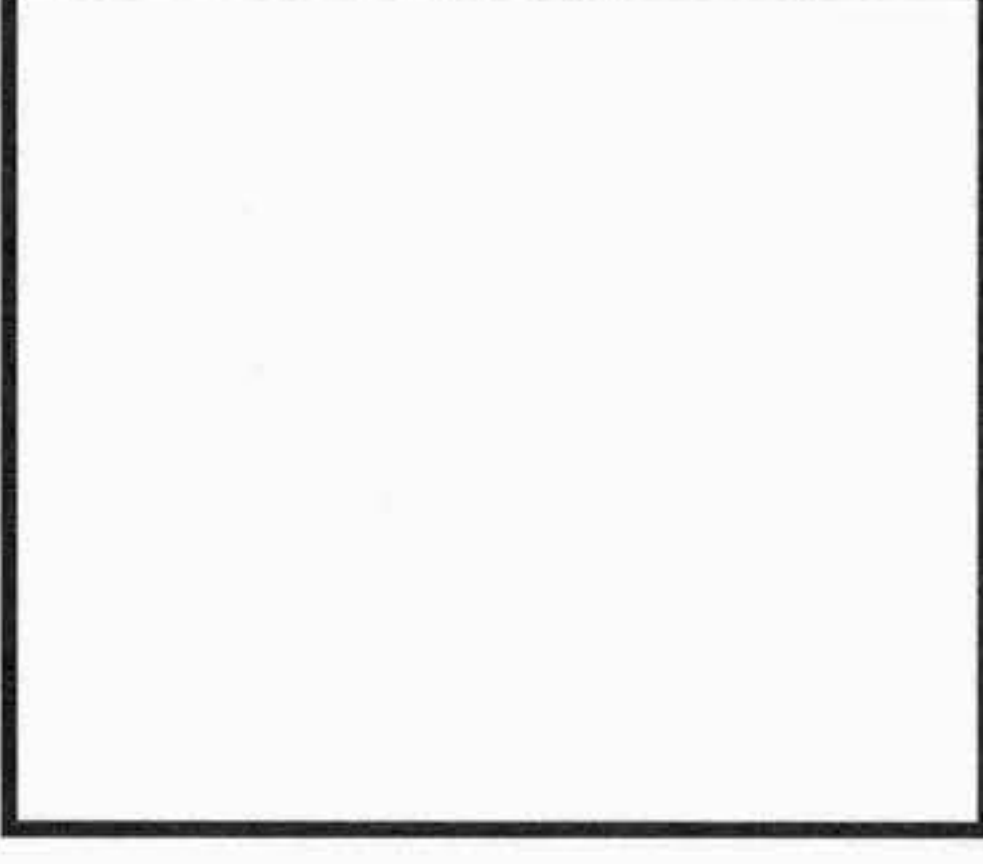

TIPO O MODELLO TYPE OU MODELE TYPE OR MODEL	MOTORE MOTEUR ENGINE	POMPA ACQUA POMPE A EAU WATER PUMP REF. / O.EM. REF	KIT RIPARAZIONE NECESSAIRE DE REP. REPAIR KIT REF. / O.EM. REF
Renault V.1 PREMIUM 50.01.857.427 50.01.854.484 50.10.550.549 50.10.550.551 50.10.550.550 50.10.550.552 50.10.477.005 50.10.477.162 50.10.477.321 50.10.477.734	PREMIUM Late Model DC11 6cyl. in line - 11L 24 Valves	<p style="text-align: center;">273.380</p> <div style="text-align: center;"></div> <p style="text-align: center;">50.01.857.427</p>	<p style="text-align: center;">273.380</p> <div style="text-align: center;"></div> <p style="text-align: center;">50.01.857.427</p>
			
			
			

RENAULT



Tel: +(0)44 1925 850082 Fax: +(0)44 1925 850083
www.spwaterpumps.co.uk

TYPE OR MODEL	ENGINE	WATER PUMP	REPAIR KIT



SECTION 37

APPLICATION

SCANIA

**WATER PUMPS WASSERPUMPEN
POMPE A EAU BOMBA DE AGUA
POMPA ACQUA**

**S.P. WATER PUMPS LTD
18 Tatton Court, Kingsland Grange, Woolston,
Warrington, Cheshire. ENGLAND. WAI 4RR
TEL: +44(0) 1925 850082 Fax: +44(0) 1925 850083
Email:sales@spwaterpumps.co.uk Web Site:www.spwaterpumps.co.uk**

TAVOLE DI CONVERSIONE
TABLE DE CONVERSION
CONVERSION TABLE

SCANIA



NUMERO ORIGINALE NUMERO ORIGINAL ORIGINAL NUMBER	NUMERO SOSTITUTIVO REPLACE PAR NUMERO REPLACED BY NUMBER	RIFERIMENTO OMP REFERENCE OMP OMP REFERENCE
14.090		295.036
14.843		295.033
33.108		295.034
35.161	277.340	
42.892		295.046
136.900		295.043
139.006		295.037
139.007		295.000
139.023	1109.869	295.053
139.038		295.032
139.190		295.029
139.308		295.031
139.309		295.039
139.314		295.042
170.199		295.047
170.684		295.048
170.686		295.061
170.687		295.052
170.688		295.056
170.827		295.058
170.968	261.576	
170.969	303.662	
170.972		295.057
171.645		295.041
171.646		295.028
177.741		295.001
195.646	265.679	
200.513	273.651	
204.466		295.059
209.050		295.025
223.882	261.515	
228.826	259.065	
228.833		295.015
228.834		295.013
228.836		295.016
231.029	261.575	
231.030		295.002
231.795		295.024
235.310	372.310	
235.909	259.064	
235.911	391.544	
235.913		295.071
243.814		295.017
258.263		295.011
258.264		295.073
258.267		295.014
259.064		295.005

NUMERO ORIGINALE NUMERO ORIGINAL ORIGINAL NUMBER	NUMERO SOSTITUTIVO REPLACE PAR NUMERO REPLACED BY NUMBER	RIFERIMENTO OMP REFERENCE OMP OMP REFERENCE
295.065		295.010
260.798		295.003
261.575		295.020
261.576		295.063
265.679	348.339	
270.681		
273.651	328.424	295.051
276.586		295.098
277.340		295.023
278.338		295.044
278.339		295.038
290.818	324.204	
290.819		295.054
290.820	361.577	
290.865	1314.336	
292.749		295.007
292.759		295.065
292.760		295.030
292.761	1314.406	
292.762	320.592	
303.662	319.727	295.049
311.024	265.679	
311.438		295.062
319.727		295.087
320.355	397.959	
320.592		295.060
324.204		295.008
325.649	348.339	
328.424		295.095
329.717		299.428
347.963	369.902	
348.118		295.075
348.339	363.143	
353.296	1354.103	
361.577		
362.129		295.097
363.143		295.018
366.556		295.093
369.534		295.078
369.902	397.957	
372.310		295.085
372.311		295.081
378.533		295.076
382.183		295.070
391.544		295.086
397.957	1338.490	
397.959		295.079

TAVOLE DI CONVERSIONE
TABLE DE CONVERSION
CONVERSION TABLE

SCANIA



NUMERO ORIGINALE NUMERO ORIGINAL ORIGINAL NUMBER	NUMERO SOSTITUTIVO REPLACE PAR NUMERO REPLACED BY NUMBER	RIFERIMENTO OMP REFERENCE OMP OMP REFERENCE
550.041		292.134
550.044		292.131
550.047		292.133
550.048	550.206	292.135
550.141		292.142
550.142		292.132
550.144	551.476	292.144
550.167		292.143
550.168		292.201
550.206		292.198
550.216		292.197
551.476		292.199
551.477		292.200
570.950	VEDI 353.296	
570.951	VEDI 1353.072	
570.952	VEDI 1365.841	
570.953	VEDI 1380.897	
571.048	VEDI 139.007	
571.054	VEDI 259.064	
571.055	VEDI 259.065	
571.057	VEDI 261.575	
571.058	VEDI 292.760	
571.059	VEDI 292.761	
571.063	VEDI 320.592	
571.065	571.067	
571.066	571.069	
571.067	VEDI 1377.571	
571.068	VEDI 382.183	
571.069	VEDI 1111.897	
571.150	VEDI 1354.103	
571.153	VEDI 1375.838	
571.154	VEDI 1375.839	
575.100	VEDI 1314.406	

NUMERO ORIGINALE NUMERO ORIGINAL ORIGINAL NUMBER	NUMERO SOSTITUTIVO REPLACE PAR NUMERO REPLACED BY NUMBER	RIFERIMENTO OMP REFERENCE OMP OMP REFERENCE
800.691		291.191
800.695		291.281
804.835		291.354
804.657		295.082
805.078		295.022
806.312		291.625
807.310		291.146
807.331		295.012
808.316		295.069
808.416		295.067
811.051	362.129	295.055
811.058		295.064
814.822		
1109.868		295.092
1109.869		295.096
1111.579	1111.897	
1111.897		295.080
1117.600		295.077
1118.544	1338.040	
1309.541		295.094
1314.336		295.006
1314.406		295.035
1331.933		295.115
1338.040		295.102
1338.490	1377.571	
1353.072		295.130
1354.103		295.100
1362.261	1375.839	
1365.841		295.140
1372.365		295.108
1374.344		295.113
1374.954	1413.135	
1375.837		295.020
1375.838		295.070
1375.839		295.110
1376.228		295.109
1377.571		295.050
1380.897		295.120
1380.899		295.105
1380.901		295.107
1382.541		295.103
1384.468		295.093
1413.135		295.111

I RIFERIMENTI ORIGINALI IN **NERETTO** SONO USATI SOLO A SCOPO INDICATIVO IN QUANTO SONO RELATIVI ALLE POMPE ACQUA RICONDIZIONATE, MENTRE TUTTA LA NOSTRA PRODUZIONE COMPRENDE ESCLUSIVAMENTE POMPE ACQUA NUOVE.

LES REFERENCES ORIGINAUX EN **MI-GRAS** SONT SEULEMENT INDICATIVES CAR ILS SONT RELATIVES AUX POMPES A EAU RECONDITIONNEES ET NOTRE PRODUCTION COMPREND NOUVELLES POMPES A EAU ESCLUSIVEMENT.

THE ORIGINAL PART NUMBER IN **BOLD-FACE** ARE ONLY USED FOR REFERENCE AS THEY REGARDS REBUILT WATER PUMPS WHILST OUR PRODUCTION CONSISTS OF NEW PUMPS ONLY.





SUITABLE

SCANIA

Tel: +44(0)1925 850082 Fax: +(0)44 1925 850083

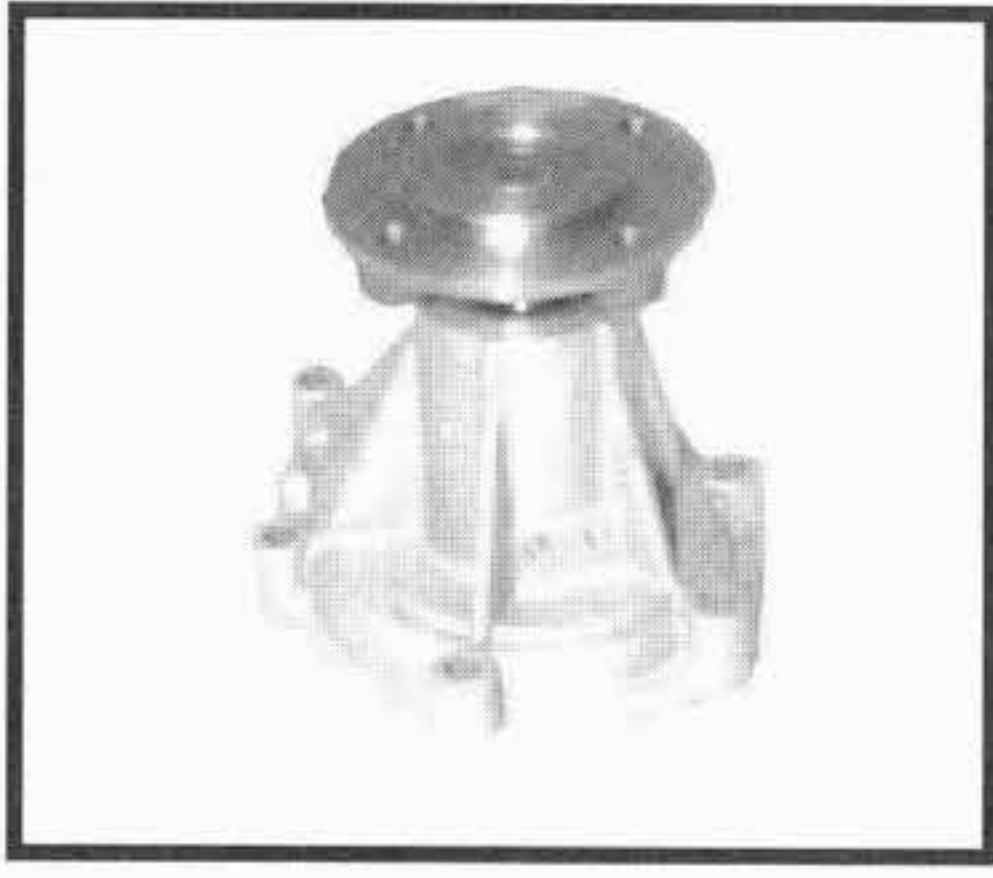
www.spwaterpumps.co.uk

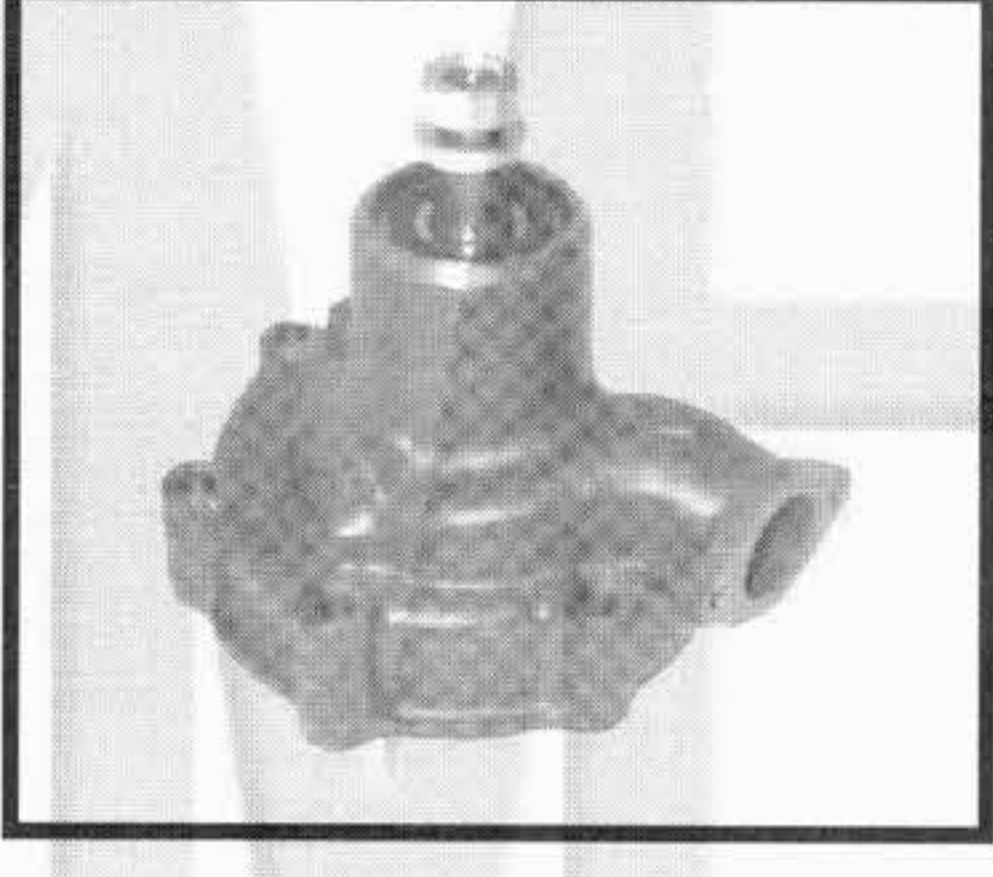
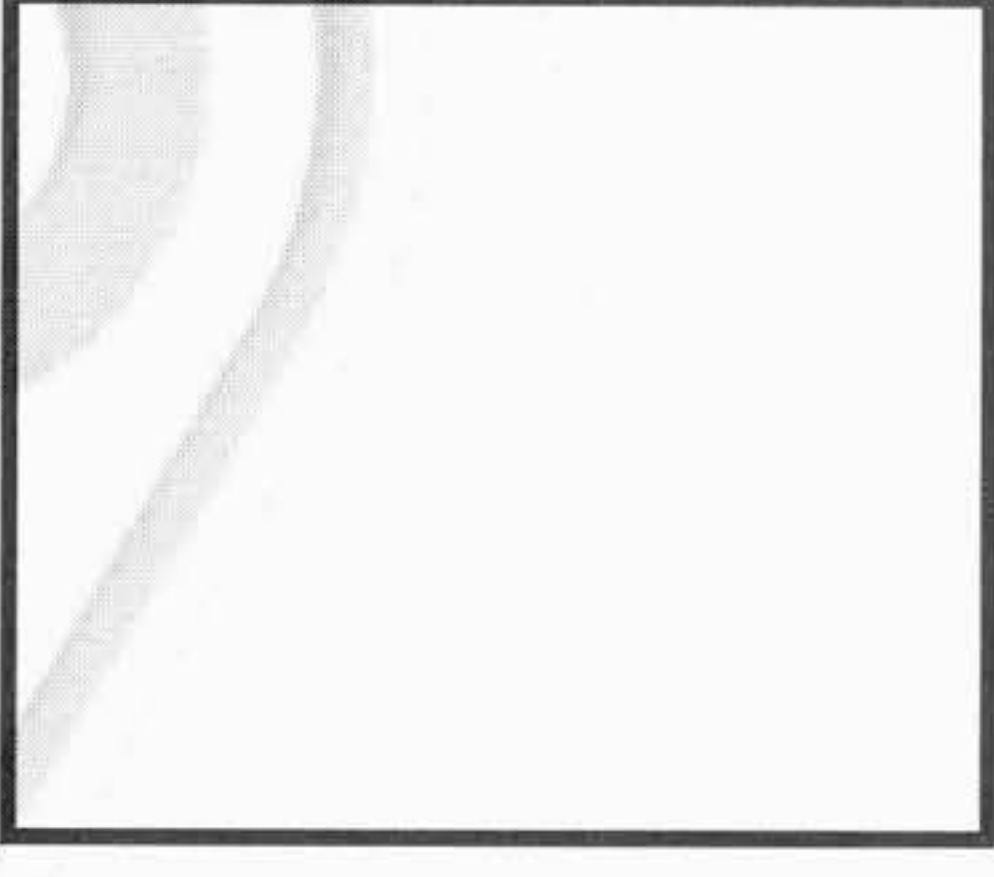

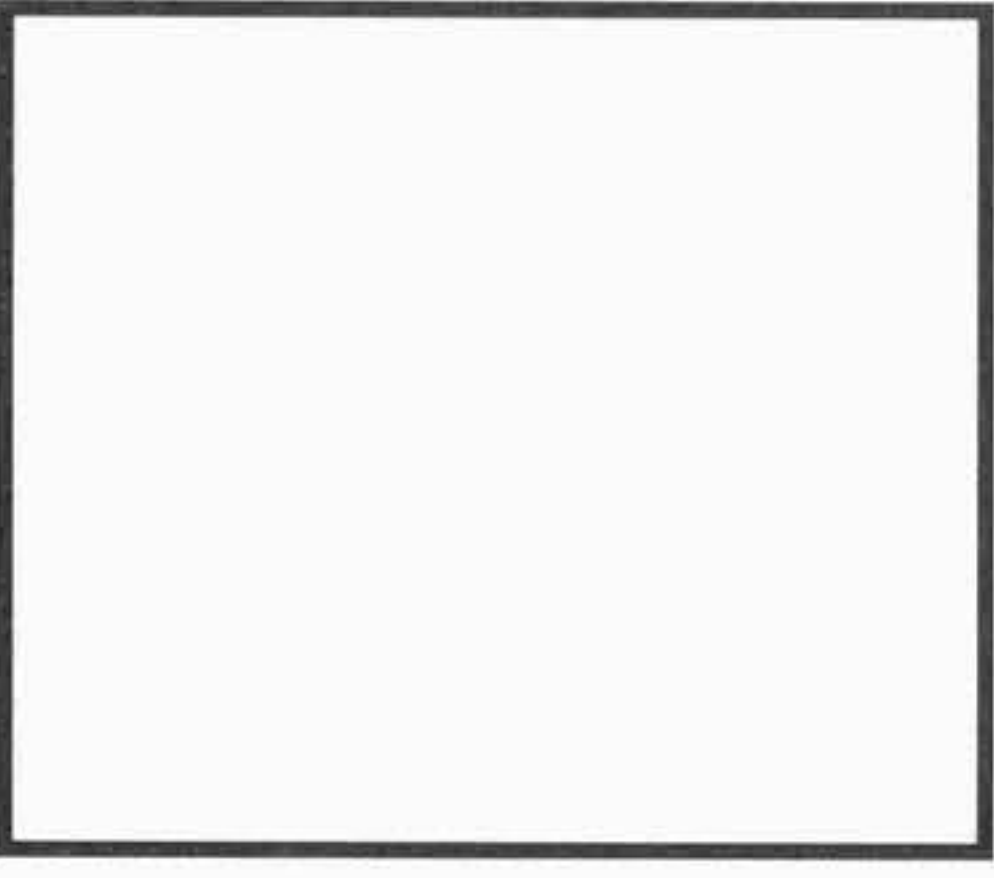
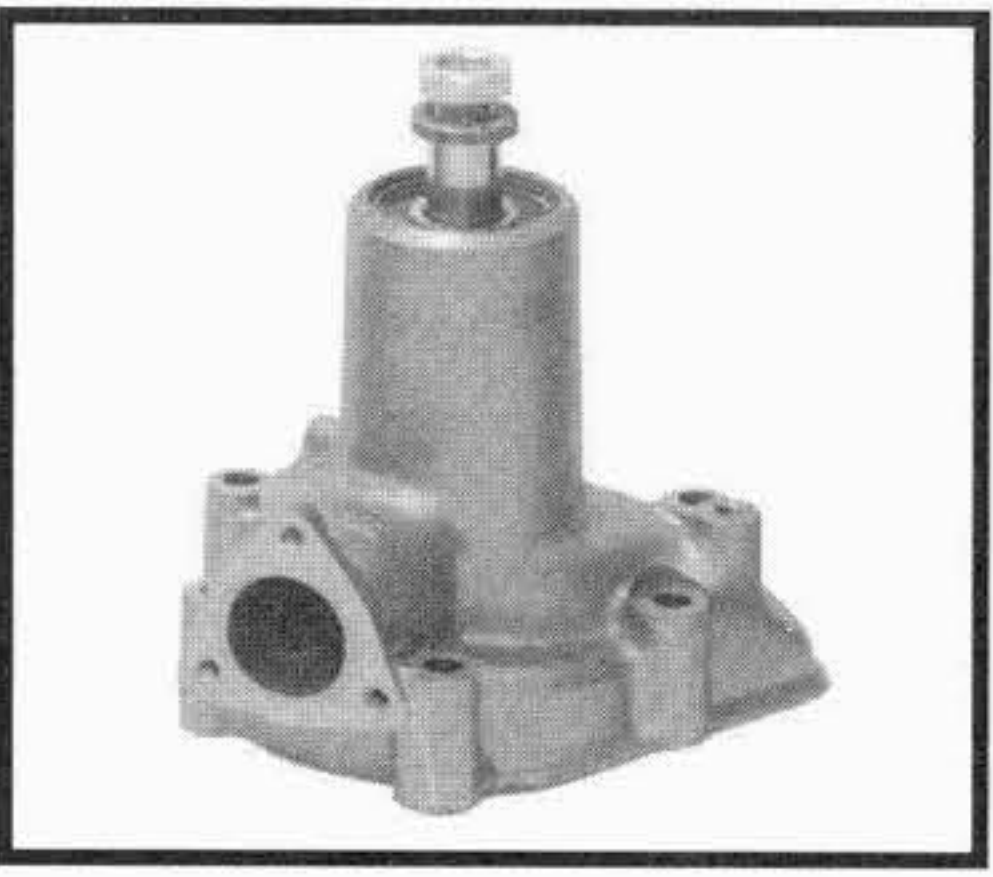
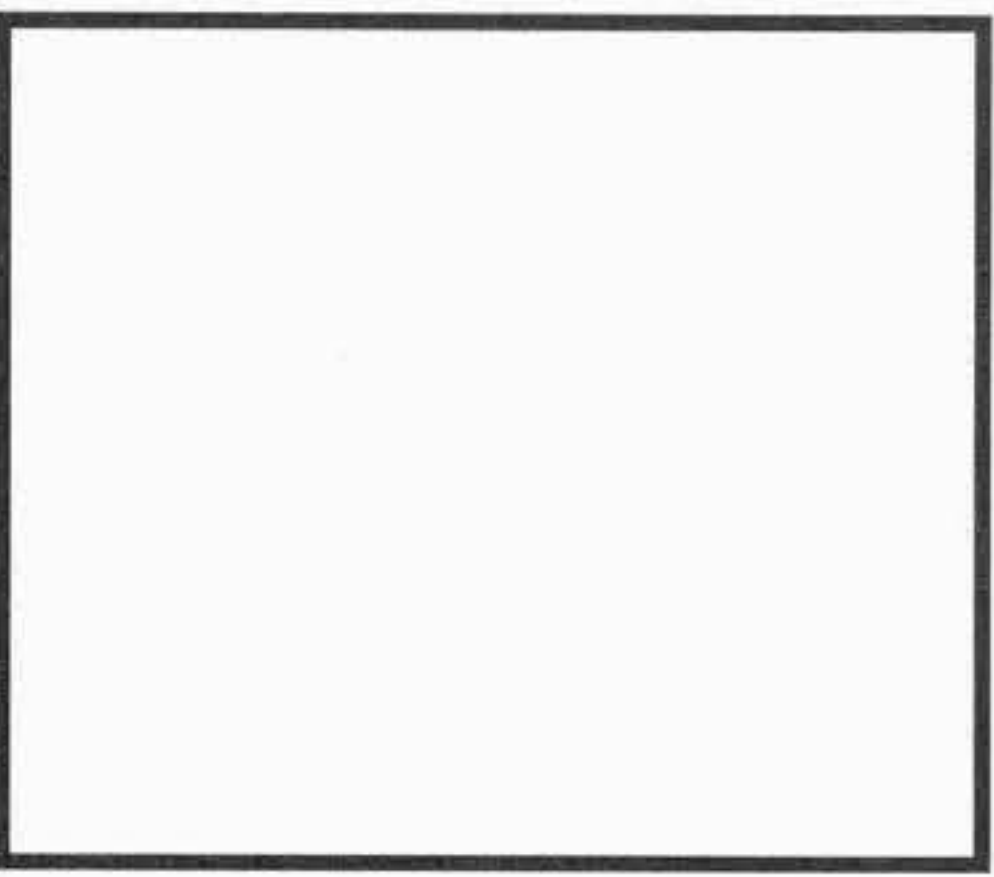
TIPO O MODELLO TYPE OU MODELE TYPE OR MODEL	MOTORE MOTEUR ENGINE	POMPA ACQUA POMPE A EAU WATER PUMP	OMP REF. / O.EM. REF	KIT RIPARAZIONE NECESSAIRE DE REP. REPAIR KIT	OMP REF. / O.EM. REF
93 Series	D9 - DS9A	<p>295.080 1111.579</p> 	<p>--- 551.454</p> 		
111 Series all models	DS 11	<p>295.010 259.065</p> 	<p>292.132 550.142</p>  <p>292.131 550.044</p>		
112 Series all models	DS 11	<p>295.035 1314.406</p> 	<p>292.143 550.167</p> 		
113 Series all models	DS 11 DSC 11	<p>295.100 1354.103</p> 	<p>292.143 550.167</p>  <p>292.201 ---</p>		

NEW !!

tutte le versioni con RITARDATORE
all version with RETARDER

I ricambi non sono originali ma adattabili . Ogni riferimento originale é assolutamente indicativo .
Spare parts are not original but perfectly suitable . Every original part number has to be considered for reference purpose only .







SUITABLE

SCANIA

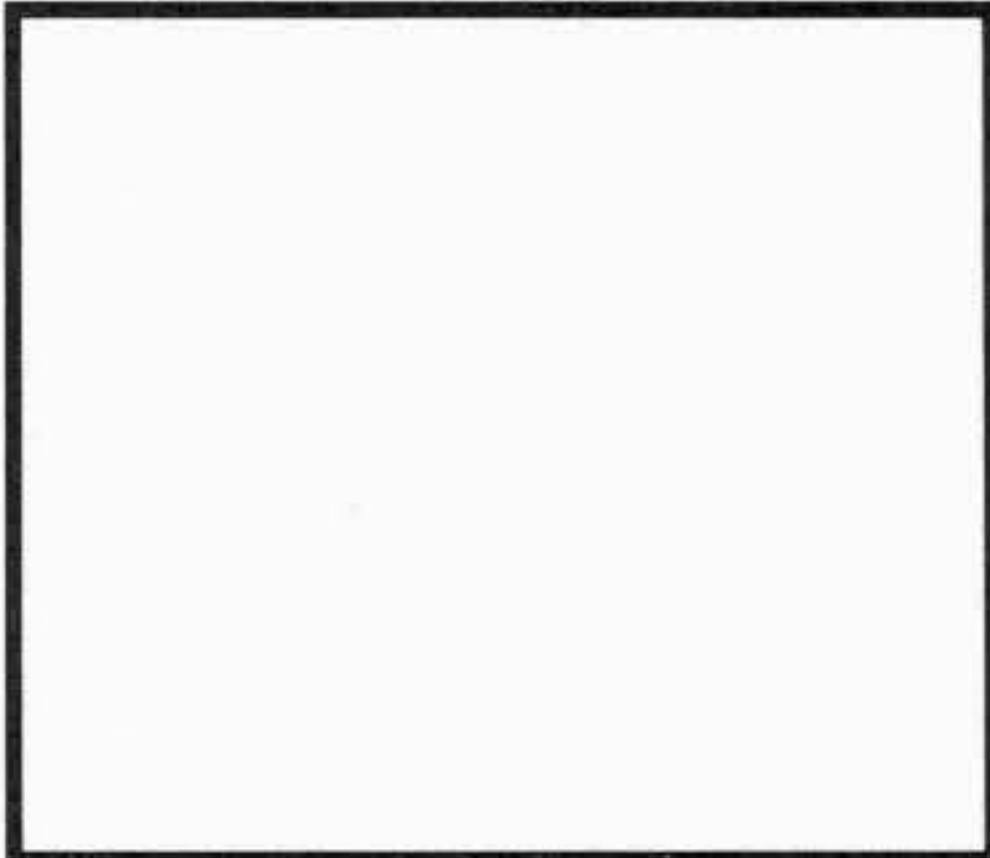
Tel: +44(0)1925 850082 Fax: +(0)44 1925 850083

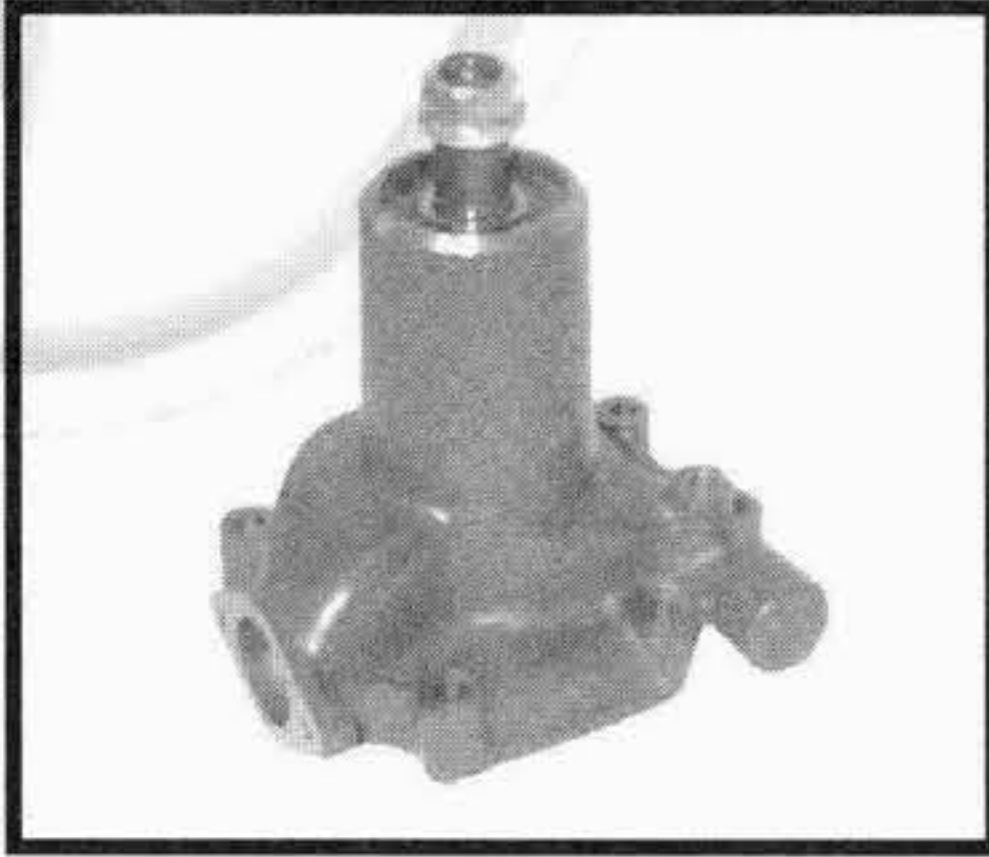
www.spwaterpumps.co.uk

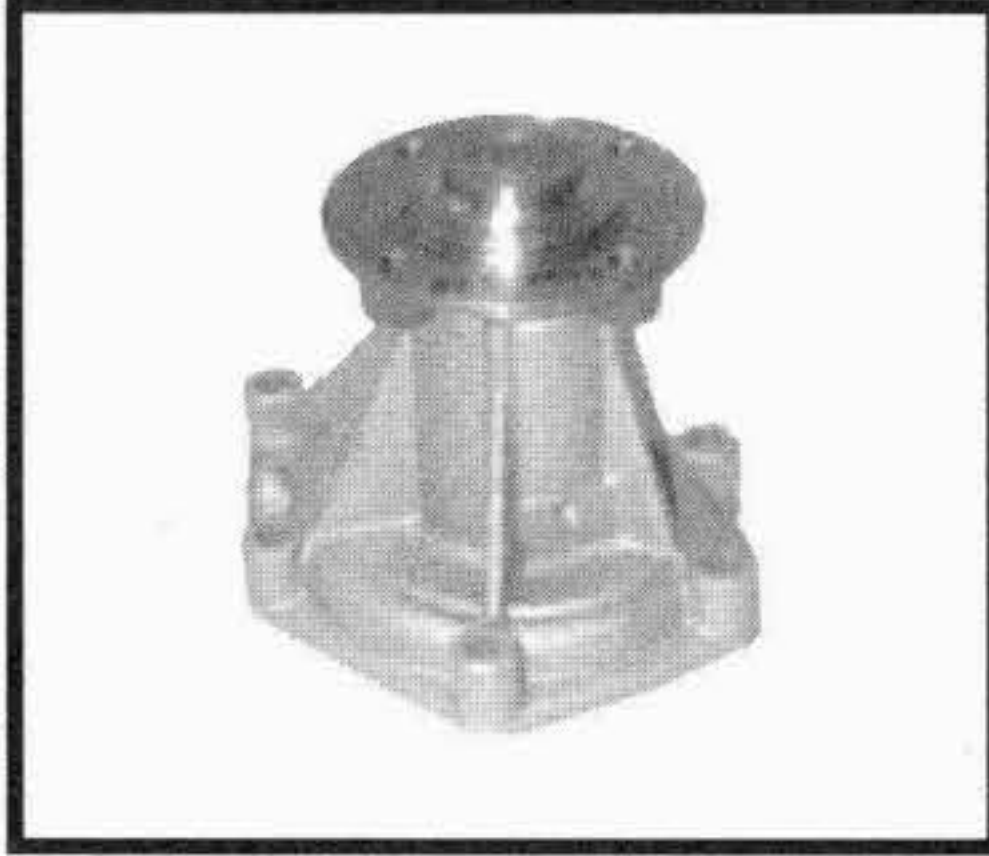

TIPO O MODELLO TYPE OU MODELE TYPE OR MODEL	MOTORE MOTEUR ENGINE	POMPA ACQUA POMPE A EAU WATER PUMP OMP REF. / O.EM. REF	KIT RIPARAZIONE NECESSAIRE DE REP. REPAIR KIT OMP REF. / O.EM. REF
<p>76 Series all models</p> <p>110 Series all models</p>	<p>D 10 DS 10</p> <p>DS 11</p>	<p>295.000 139.007</p> 	<p>292.133 550.047</p>  <p>292.134 550.041</p>
<p>81 Series all models</p> <p>86 Series all models</p>	<p>D 8 - DS 8</p> <p>D 8 - DS 8</p>	<p>295.005 259.064</p> 	<p>292.132 550.142</p>  <p>292.142 550.141</p>
<p>82 Series all models</p>	<p>DS 8</p>	<p>295.030 292.760</p> 	<p>292.143 550.167</p>  <p>292.142 550.141</p>
<p>92 Series</p> <p>93 Series</p>	<p>DN 9 DS 9 DSC 9 L DS 9 B</p> <p>DN 9 DS 9 DSC 9 L DS 9 B</p>	<p>295.050 1338.490</p> 	<p>---</p> <p>551.454</p> 

I ricambi non sono originali ma adattabili . Ogni riferimento originale é assolutamente indicativo .
 Spare parts are not original but manufacturable suitable . Every original part number has to be considered for reference purposes .





SUITABLE

SCANIA

Tel:+44(0)1925 850082 Fax: +(0)44 1925 850083

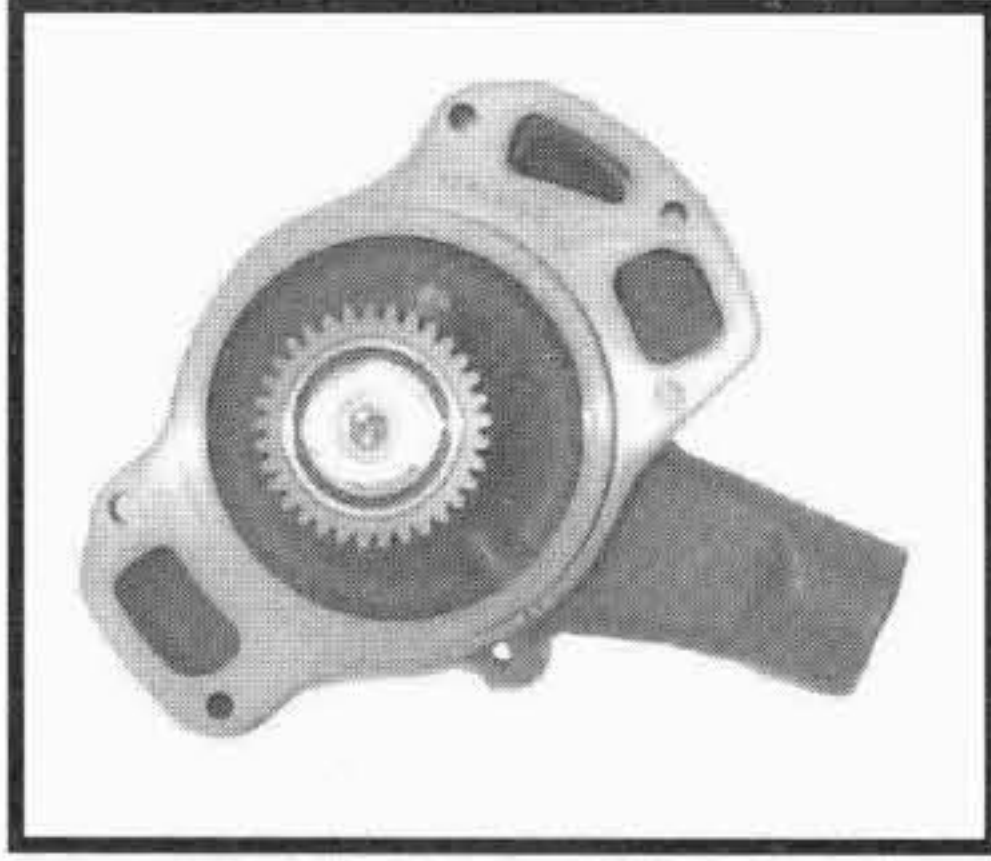
www.spwaterpumps.co.uk

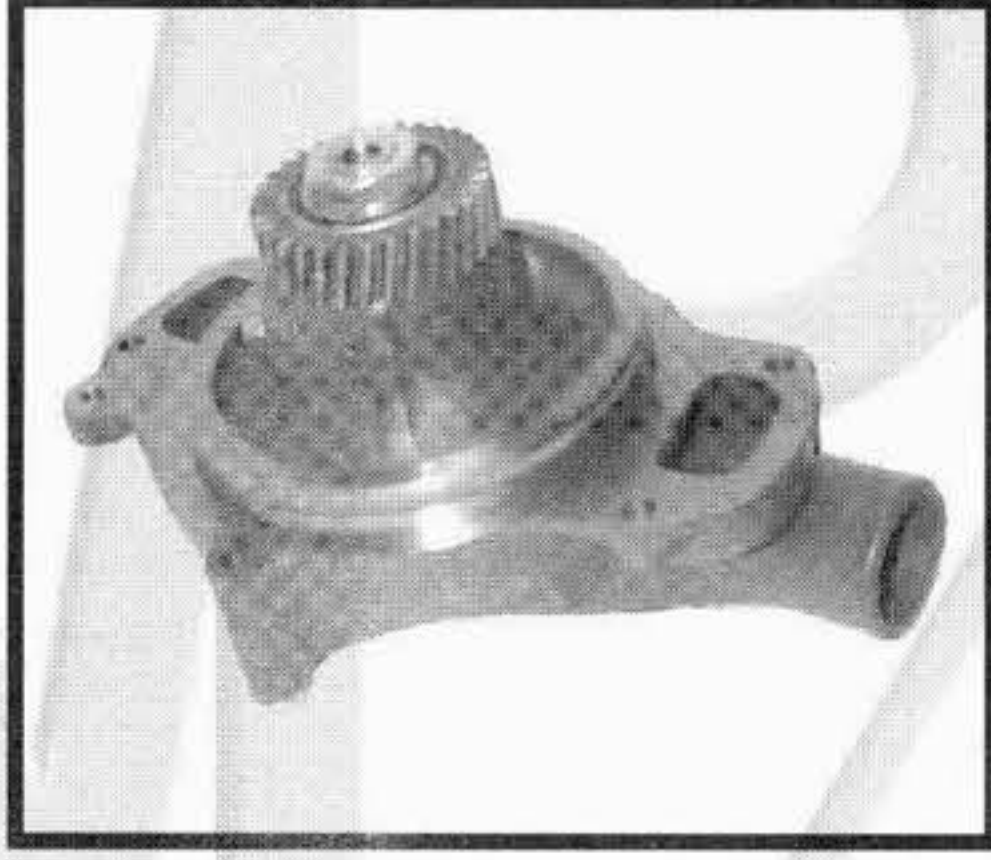
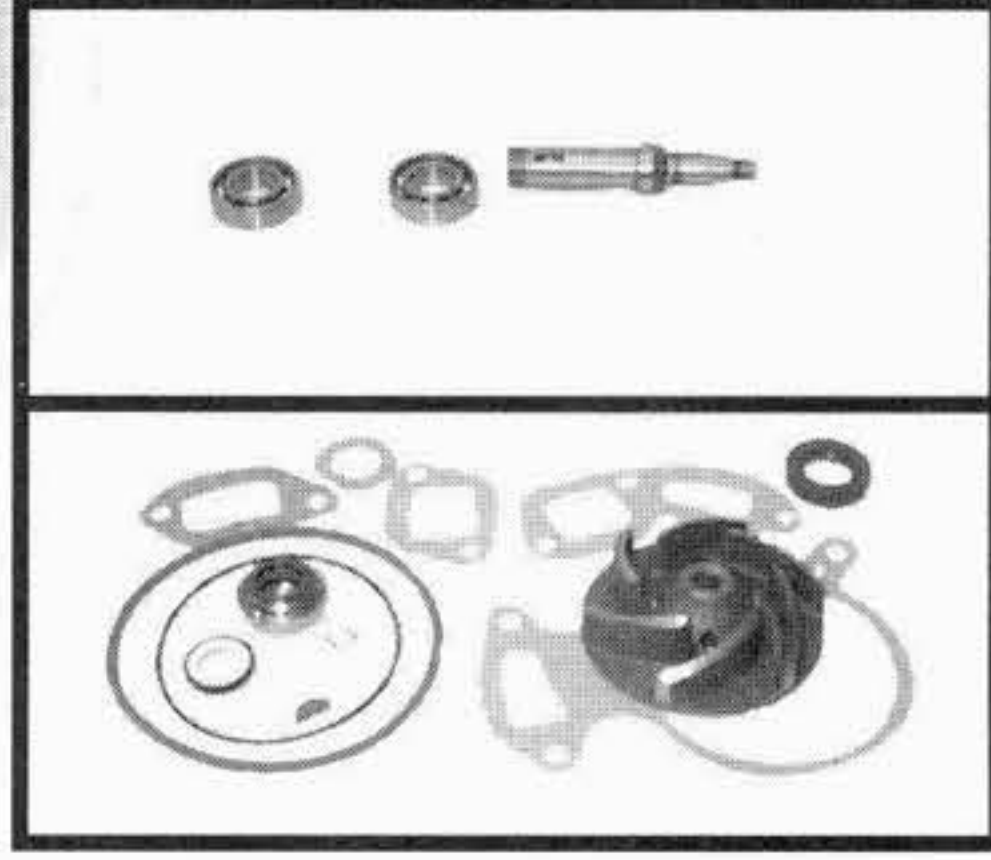

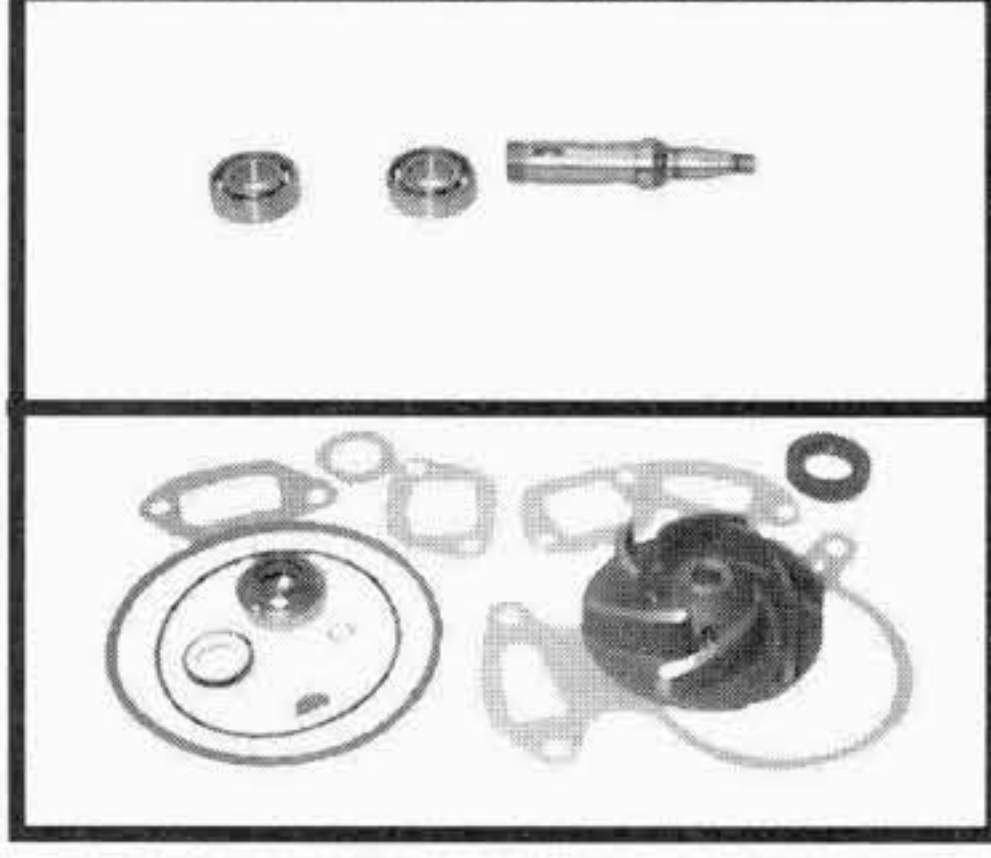
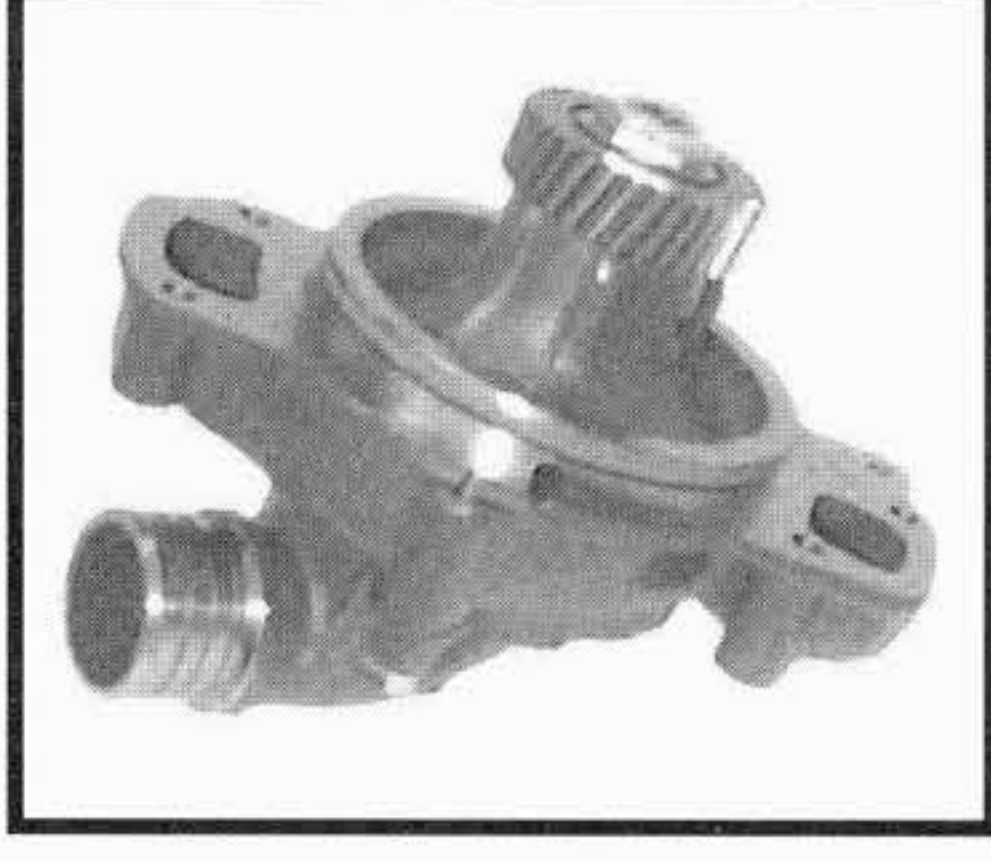
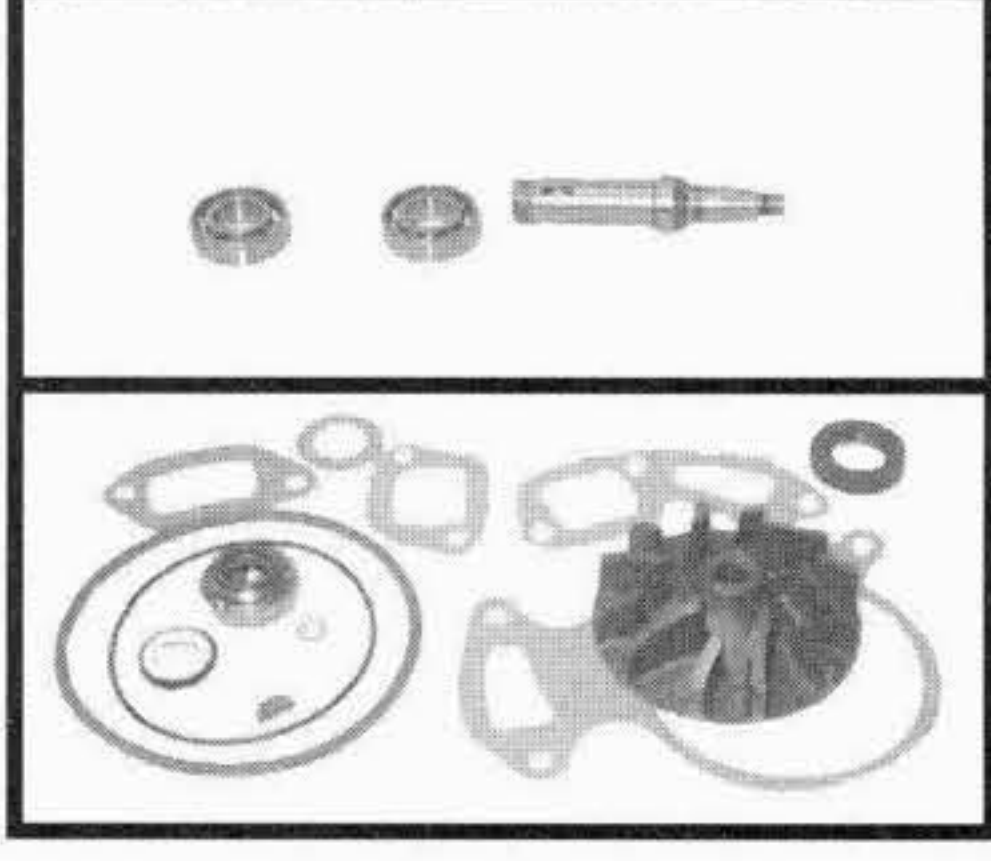
TIPO O MODELLO TYPE OU MODELE TYPE OR MODEL	MOTORE MOTEUR ENGINE	POMPA ACQUA POMPE A EAU WATER PUMP	KIT RIPARAZIONE NECESSAIRE DE REP. REPAIR KIT
		OMP REF. / O.EM. REF	OMP REF. / O.EM. REF
<p>140 Series all models</p> <p>141 Series all models</p> <p>146 Series all models</p>	<p>D 14 - DS 14</p> <p>D 14 - DS 14</p> <p>D 14 - DS 14</p>	<p>295.020 261.575</p> 	<p>292.198 550.206</p>  <p>292.199 551.476</p>
<p>142 Series all models</p>	<p>DS 14</p> <p>DSC 14</p> <p>DS 14 06</p> <p>DSC 14 01</p>	<p>295.060 320.592</p> 	<p>292.198 550.206</p>  <p>292.199 551.476</p>
<p>143 Series all models</p>	<p>DSC 14 03</p> <p>DSC 14 06</p>	<p>295.070 382.183</p> 	<p>292.198 550.206</p>  <p>292.199 551.476</p>
<p>143 Series all models</p> <p>NEW !!</p> <p>tutte le versioni con RITARDATORE</p> <p>all version with RETARDER</p>	<p>DSC 14 03</p> <p>DSC 14 06</p>	<p>295.110 1375.839</p> 	<p>292.198 550.206</p>  <p>292.200 551.477</p>

I ricambi non sono originali ma adattabili . Ogni riferimento originale é assolutamente indicativo .
Spare parts are not original but perfectly suitable . Every original part number has to be considered for reference purpose only .

SUITABLE

SCANIA

AUTOCARRI - TRUCKS & AUTOBUS

Tel: +44(0)1925 850082 Fax: +44(0)1925 850083

www.spwaterpumps.co.uk

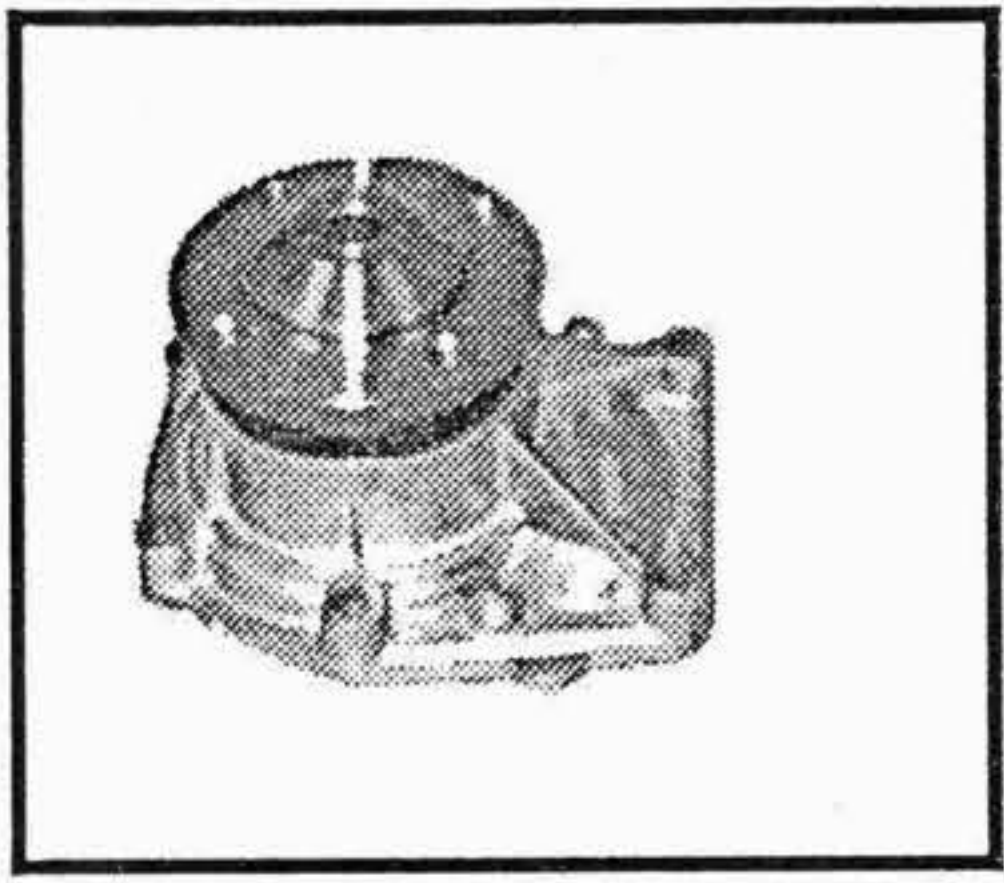
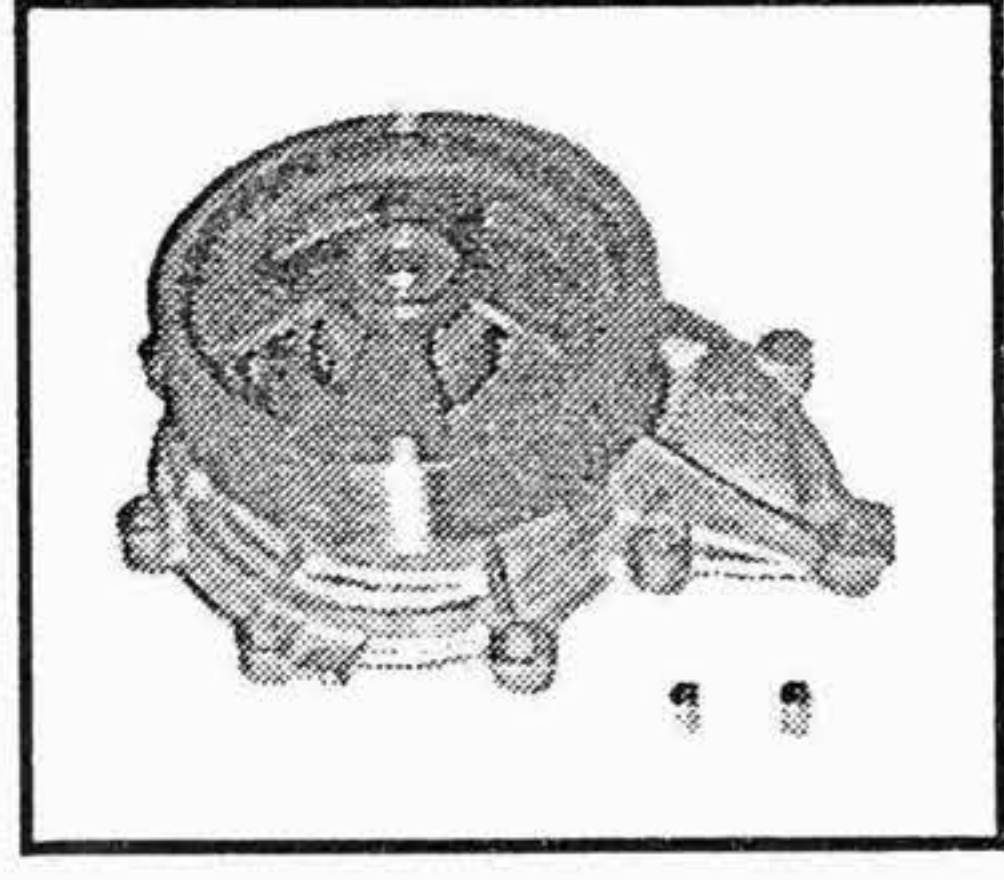
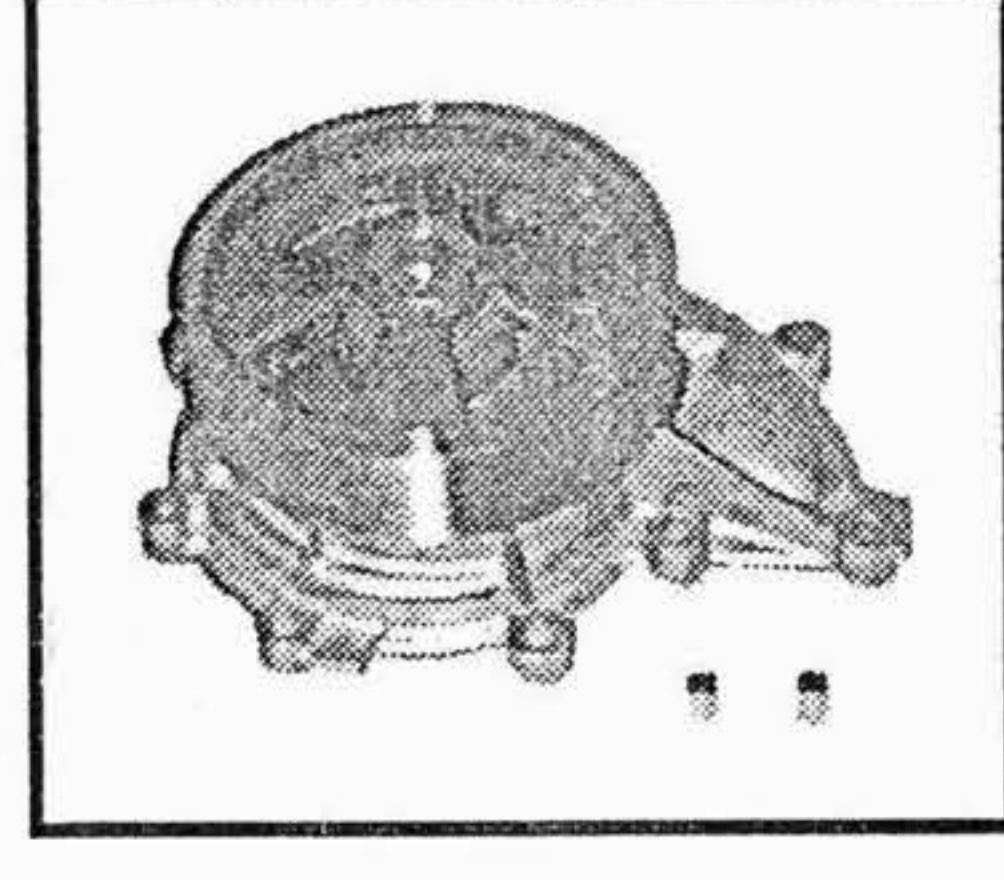
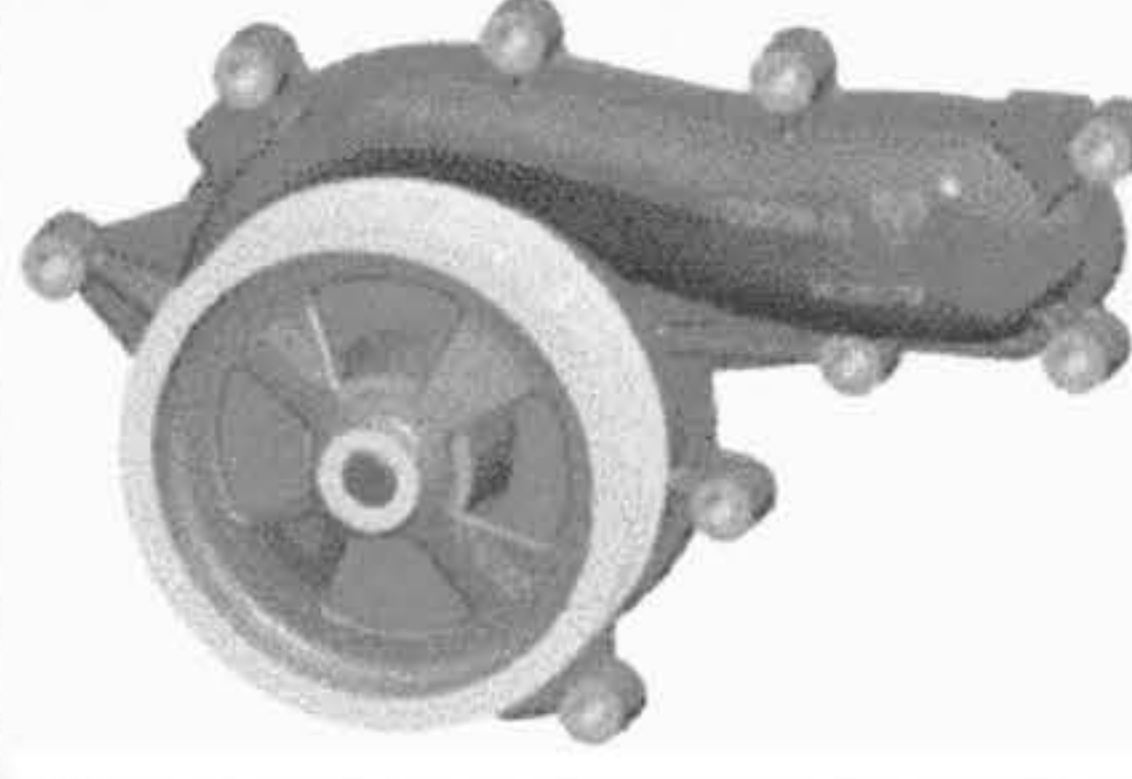

TIPO O MODELLO TYPE OU MODELE TYPE OR MODEL	MOTORE MOTEUR ENGINE	POMPA ACQUA POMPE A EAU WATER PUMP	KIT RIPARAZIONE NECESSAIRE DE REP. REPAIR KIT
94 Series all models 570957 1510490	DSC 9 11/12/13/15 DS 9 AM DSC 9 AM DSI 9 AM DSC 9 B	295.120 1380.897 	295.122 1546188 <div style="border: 1px solid black; padding: 5px; text-align: center;"> SCANIA DC9 P & R Series AWAITING PHOTO 570964 1546188 </div>
114 Series all models 124 Series all models 570955 1508533	DSC 11 DSC 12	295.130 1353.072 	--- --- <div style="border: 1px solid black; padding: 10px; text-align: center; transform: rotate(-15deg);"> NON DISPONIBILE NOT AVAILABLE </div>
144 Series all models 1508534 5709564 570956	DSC 14 13/15	295.140 1365.841 	--- --- <div style="border: 1px solid black; padding: 10px; text-align: center; transform: rotate(-15deg);"> NON DISPONIBILE NOT AVAILABLE </div>
164 Srs R500 R580 R620 1433792 1510404 570954 1510405	DSC 16 V8 15.6	295.160  O.E.M.: Pompa Acqua senza coperchio / Water pump without backplate Pompa acqua completa / Water pump with backplate oe 1433792	

I ricambi non sono originali ma adattabili . Ogni riferimento originale é assolutamente indicativo .
 Spare parts are not original but perfectly suitable . Every original part number has to be considered for reference purpose only .



SECTION 41

APPLICATION

VOLVO

**WATER PUMPS WASSERPUMPEN
POMPE A EAU BOMBA DE AGUA
POMPA ACQUA**

S.P. WATER PUMPS LTD
18 Tatton Court, Kingsland Grange, Woolston,
Warrington, Cheshire. ENGLAND. WAI 4RR
TEL: +44(0) 1925 850082 Fax: +44(0) 1925 850083
Email:sales@spwaterpumps.co.uk Web Site:www.spwaterpumps.co.uk

TAVOLE DI CONVERSIONE
TABLE DE CONVERSION
CONVERSION TABLE

VOLVO



NUMERO ORIGINALE NUMERO ORIGINAL ORIGINAL NUMBER	NUMERO SOSTITUTIVO REPLACE PAR NUMERO REPLACED BY NUMBER	RIFERIMENTO OMP REFERENCE OMP OMP REFERENCE
11.012		
11.013		311.809
11.020		
18.559		317.076
70.913		317.004
114.027		317.078
181.286		317.028
181.538		317.017
181.670	1660.609	
181.785		319.028
192.154		319.041
270.791		312.175
271.134	3097.084	
275.607	276.806	312.170
275.608	275.618	
275.609	3097.204	312.173
275.613		312.169
275.614		312.176
275.615	276.802	312.171
275.617		312.177
275.618	276.800	312.172
275.623	3097.203	312.174
275.624	275.625	
275.625	276.053	
275.986	276.800	312.178
276.053	276.054	
276.054	276.803	
276.121		312.291
276.636		312.292
276.637		312.293
276.800		312.285
276.802		312.276
276.803	276.835	
276.806		312.275
276.814		312.278
276.835		312.277
276.852		312.296
417.638		317.103
420.150	420.262	
420.156		317.056
420.160		317.008
420.162		317.051
420.169		317.053
420.262	465.242	
420.759	465.884	
421.148		317.116
421.150	421.275	

NUMERO ORIGINALE NUMERO ORIGINAL ORIGINAL NUMBER	NUMERO SOSTITUTIVO REPLACE PAR NUMERO REPLACED BY NUMBER	RIFERIMENTO OMP REFERENCE OMP OMP REFERENCE
421.174	1542.833	
421.275	466.833	
421.306		317.007
422.148		317.115
422.150	422.311	
422.171		317.065
422.202		317.015
422.311		317.050
422.312	467.906	
422.791	1675.945	317.190
422.792		
423.125		317.113
423.127		317.039
423.129		317.042
423.148		317.118
423.333		317.090
423.351		317.094
423.352		317.095
423.459		317.106
423.460		317.107
424.032	469.418	
424.033	469.115	
424.035		317.117
424.036		
424.037		317.074
424.038		317.079
424.138	469.015	
424.722	425.268	
424.971	425.267	
424.973		
425.267		317.280
425.268		317.290
425.308		317.180
425.524	425.308	
425.707	425.751	
425.751		317.300
425.961	425.751	
465.242		317.040
465.475	1698.613	
465.542	1699.783	
465.765	1699.783	
465.884	471.500	
466.078		317.054
466.088		317.030
466.091		317.052
466.268	466.833	
466.286		317.055

OGNI RIFERIMENTO ORIGINALE E' ASSOLUTAMENTE INDICATIVO. CHAQUE REFERENCE ORIGINAL EST ABSOLUMENT INDICATIVE. EVERY ORIGINAL PART NUMBER HAS TO BE CONSIDERED FOR REFERENCE PURPOSE ONLY.

TAVOLE DI CONVERSIONE
TABLE DE CONVERSION
CONVERSION TABLE

VOLVO



NUMERO ORIGINALE NUMERO ORIGINAL ORIGINAL NUMBER	NUMERO SOSTITUTIVO REPLACE PAR NUMERO REPLACED BY NUMBER	RIFERIMENTO OMP REFERENCE OMP OMP REFERENCE
466.756	466.833	
466.833	1698.614	
467.181		317.112
467.204	467.915	
467.575		317.023
467.576		317.069
467.686	467.907	
467.687		317.022
467.906	1698.615	317.060
467.907	1545.248	
467.915	1545.427	317.070
468.245		317.033
468.246		317.034
468.247		317.029
468.250	468.937	
468.937	470.232	
469.015		317.086
469.115	469.861	
469.418		317.038
469.477		317.096
469.714		
469.744	425.308	
469.746		
469.749		
469.750		
469.751		
469.825		
469.827		
469.828		
469.861	1698.611	
470.216		317.031
470.232	1545.261	
470.265		317.114
471.500	477.397	
477.397	8192.050	
477.770	8192.050	
478.845	1675.945	
479.164	479.931	
479.418	425.751	
479.931	1675.945	
482.226		
482.227		319.018
482.228		319.017
482.229		319.019
482.232		
483.401		
484.035		319.022

NUMERO ORIGINALE NUMERO ORIGINAL ORIGINAL NUMBER	NUMERO SOSTITUTIVO REPLACE PAR NUMERO REPLACED BY NUMBER	RIFERIMENTO OMP REFERENCE OMP OMP REFERENCE
484.036		
484.094	484.118	
484.118		317.120
914.459		317.077
914.462		317.018
914.526		311.184
925.069	925.092	
925.091		317.049
925.092		317.093
925.254		317.045
925.255		317.087
925.257		317.046
925.262		317.044
925.266		
940.100		317.035
940.135		317.104
941.906	955.920	
941.907	955.894	
942.624		
943.370		317.089
943.371		317.092
943.479		317.123
950.533		317.075
951.739		317.082
951.967		317.085
951.969		317.019
953.243		317.072
953.249		317.024
955.295		311.238
955.513		317.036
955.525		317.057
955.826		317.025
955.852		319.031
955.894	955.921	
955.900		319.032
955.920		317.037
955.921		311.381
958.811		317.032
1542.198		317.137
1542.229		317.136
1542.230	1698.612	
1542.232		317.133
1542.235		317.135
1542.236		317.134
1542.833	1545.283	
1542.870		317.014
1542.871		317.016

OGNI RIFERIMENTO ORIGINALE E' ASSOLUTAMENTE INDICATIVO. CHAQUE REFERENCE ORIGINAL EST ABSOLUMENT INDICATIVE. EVERY ORIGINAL PART NUMBER HAS TO BE CONSIDERED FOR REFERENCE PURPOSE ONLY.

TAVOLE DI CONVERSIONE
TABLE DE CONVERSION
CONVERSION TABLE

VOLVO



NUMERO ORIGINALE NUMERO ORIGINAL ORIGINAL NUMBER	NUMERO SOSTITUTIVO REPLACE PAR NUMERO REPLACED BY NUMBER	RIFERIMENTO OMP REFERENCE OMP OMP REFERENCE
5001.098	VEDI 420.262	
5001.099	VEDI 421.275	
5001.100	VEDI 422.312	
5001.101	VEDI 422.311	
5001.102	VEDI 469.861	
5001.293	VEDI 423.333	
5001.384	VEDI 468.250	
5001.386	VEDI 466.088	
5001.503	VEDI 465.242	
5001.536	VEDI 466.268	
5001.538	VEDI 484.118	
5001.720	VEDI 1542.230	
5001.725	VEDI 465.475	
5001.726	VEDI 465.765	
5001.738	VEDI 466.756	
5002.208	VEDI 467.906	
5002.225	VEDI 470.232	
5002.726	VEDI 465.765	
5002.764	VEDI 1545.261	
5002.803	VEDI 1545.246	
5002.804	VEDI 1545.248	
5002.878	VEDI 1545.427	
5003.070	VEDI 497.744	
5003.092	VEDI 471.500	
5003.093	VEDI 465.884	
5003.213	VEDI 1545.460	
5003.239	VEDI 465.542	
5003.240	VEDI 466.833	
5003.334	VEDI 1543.380	
5003.351	VEDI 422.791	
5003.457	VEDI 425.268	
8112.184	VEDI 477.397	
8112.185	VEDI 8192.050	
8112.354	VEDI 424.973	
8112.355	VEDI 425.308	
8112.356	VEDI 425.268	
8112.515	VEDI 1699.781	

NUMERO ORIGINALE NUMERO ORIGINAL ORIGINAL NUMBER	NUMERO SOSTITUTIVO REPLACE PAR NUMERO REPLACED BY NUMBER	RIFERIMENTO OMP REFERENCE OMP OMP REFERENCE
8112.517	VEDI 1699.783	
8112.518	VEDI 1699.784	
8112.519	VEDI 1699.785	
8112.521	VEDI 1699.788	
8112.522	VEDI 1699.789	
8112.523	8112.683	
8112.526	VEDI 1698.622	
8112.555	VEDI 1547.155	
8112.620	VEDI 1543.960	
8112.650	VEDI 1543.380	
8112.661	VEDI 479.418	
8112.683	VEDI 1675.945	
8112.775	VEDI 8148.460	
8112.849	VEDI 425.751	
8112.889	VEDI 1676.713	
8113.116	VEDI 8149.980	
8113.117	VEDI 8149.941	
8113.155	VEDI 8149.882	
8113.222	VEDI 425.751	
8113.157	VEDI 8149.937	

I RIFERIMENTI ORIGINALI **IN NERETTO** SONO USATI SOLO A SCOPO INDICATIVO IN QUANTO SONO RELATIVI ALLE POMPE ACQUA RICONDIZIONATE, MENTRE TUTTA LA NOSTRA PRODUZIONE COMPRENDE ESCLUSIVAMENTE POMPE ACQUA NUOVE.

LES REFERENCES ORIGINAUX **EN MI-GRAS** SONT SEULEMENT INDICATIVES CAR ILS SONT RELATIVES AUX POMPES A EAU RECONDITIONNEES ET NOTRE PRODUCTION COMPREND NOUVELLES POMPES A EAU ESCLUSIVEMENT.

THE ORIGINAL PART NUMBER **IN BOLD-FACE** ARE ONLY USED FOR REFERENCE AS THEY REGARDS REBUILT.WATER PUMPS WHILST OUR PRODUCTION CONSISTS OF NEW PUMPS ONLY.

OGNI RIFERIMENTO ORIGINALE E' ASSOLUTAMENTE INDICATIVO. CHAQUE REFERENCE ORIGINAL EST ABSOLUMENT INDICATIVE. EVERY ORIGINAL PART NUMBER HAS TO BE CONSIDERED FOR REFERENCE PURPOSE ONLY.

SUITABLE

VOLVO



PENTA

MOTORI

Tel:+44(0)1925 850082 Fax: +(0)44 1925 850083

www.spwaterpumps.co.uk

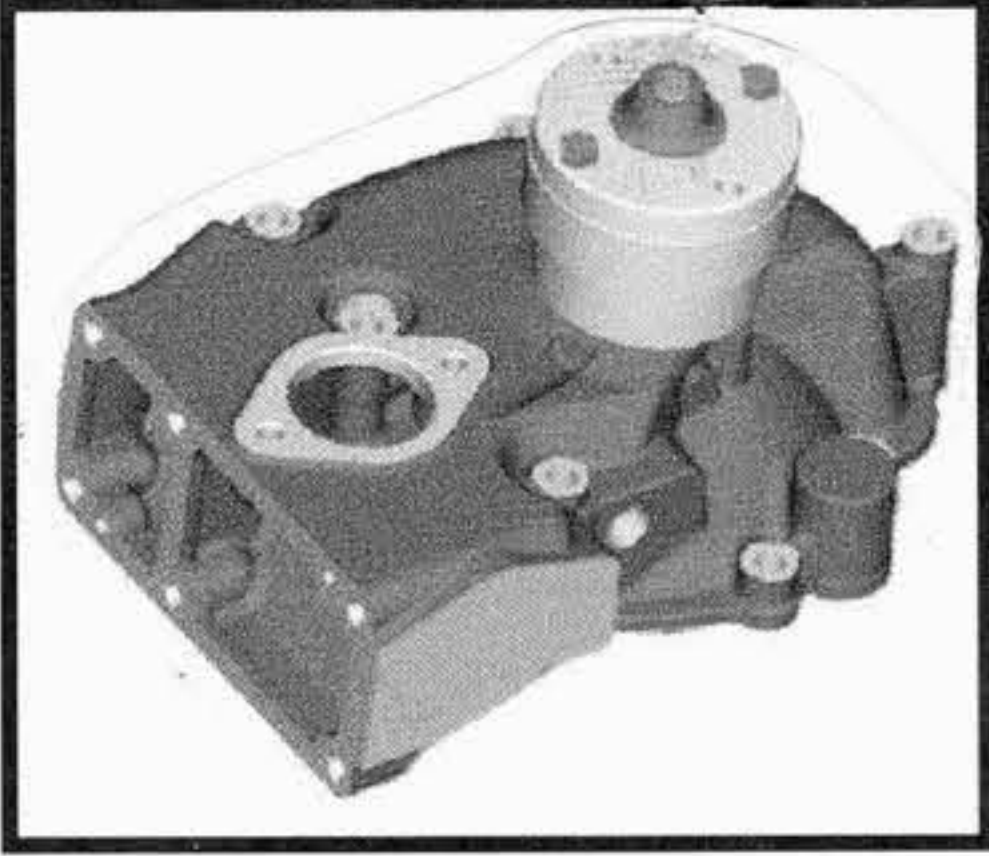
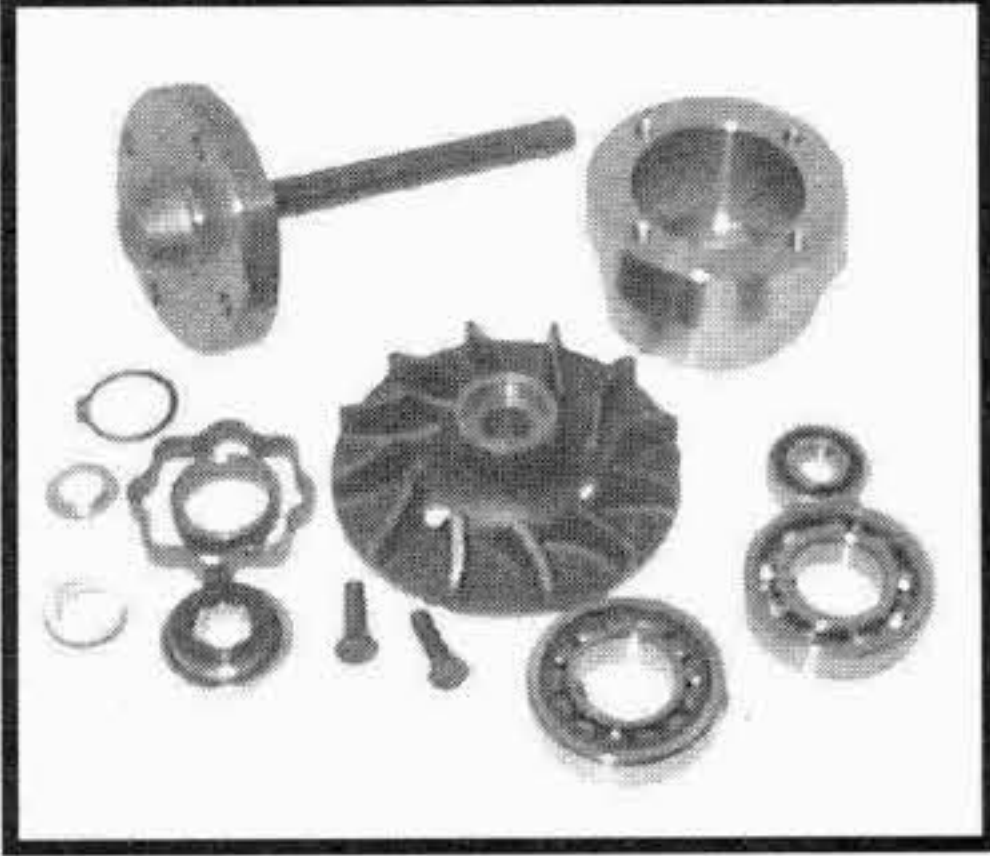
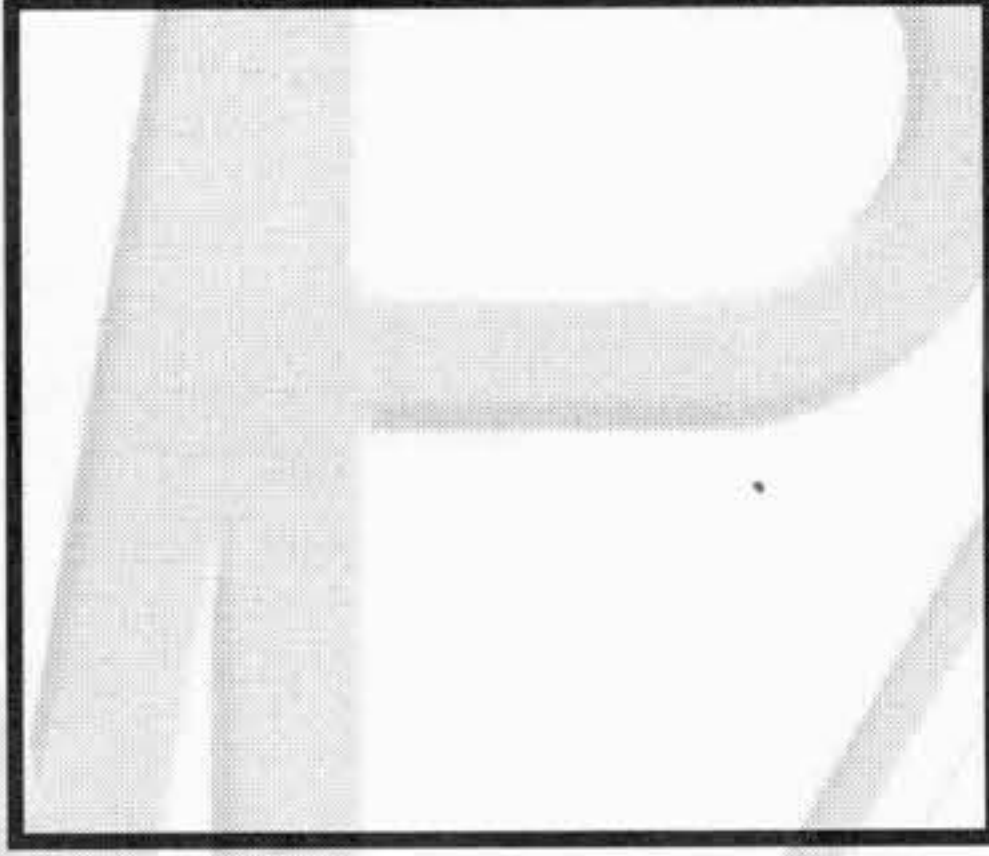

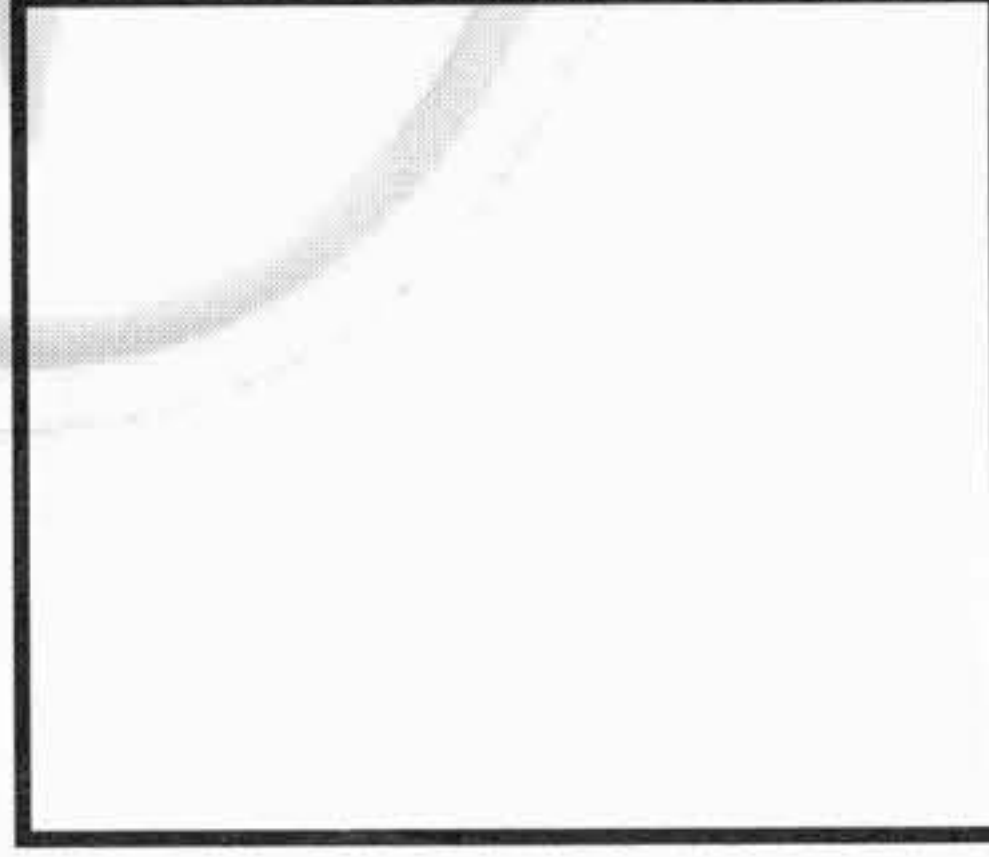
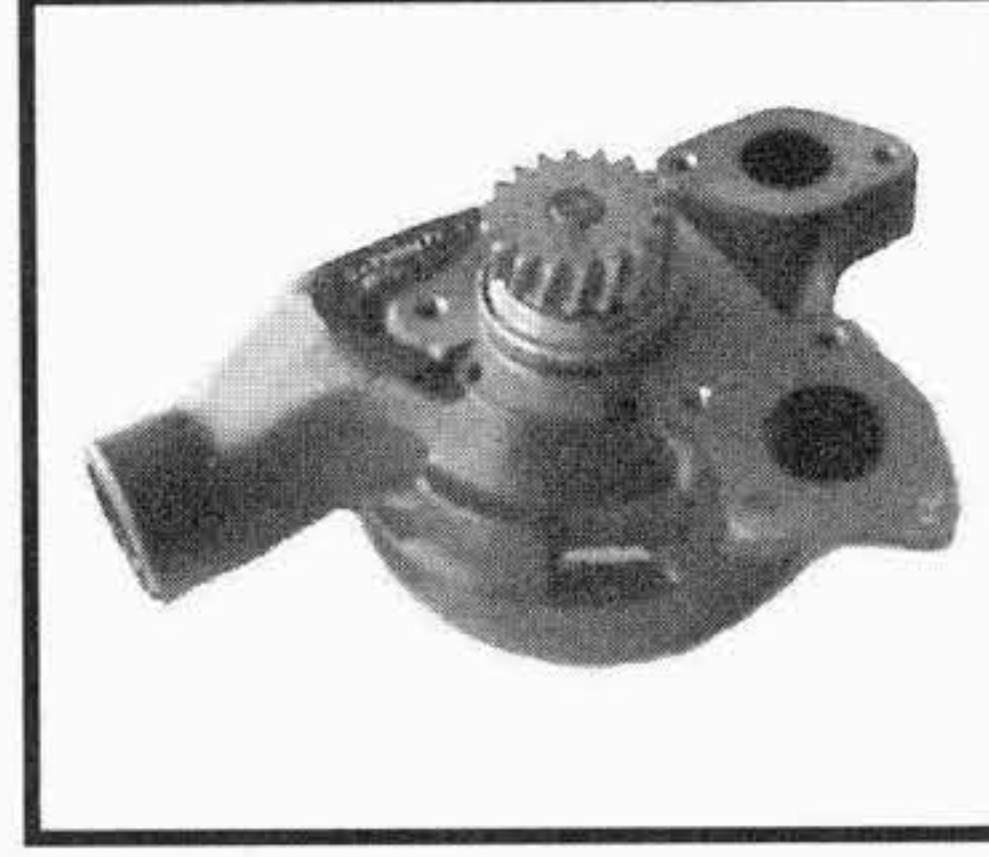
TIPO O MODELLO TYPE OU MODELE TYPE OR MODEL	MOTORE MOTEUR ENGINE	POMPA ACQUA POMPE A EAU WATER PUMP	KIT RIPARAZIONE NECESSAIRE DE REP. REPAIR KIT
		OMP REF. / O.EM. REF	OMP REF. / O.EM. REF
<p>NEW !!</p>	<p>TD 100 G</p>	<p>--- 844.379</p> 	<p>312.290 875.661</p> 
<p>NEW !!</p>	<p>F 4 TD 40 A</p>	<p>317.130 1699.782</p> 	<p>312.177 275.617</p> 
<p>NEW !!</p>	<p>FL 4 TD 41 G 8112525 8112635 Body 1542231</p>	<p>--- 1698.622</p> 	<p>--- ---</p> <p>NON DISPONIBILE NOT AVAILABLE</p>
<p>NEW !!</p>	<p>FLC D4A 135 8113246 3976821</p>	<p>319.510 ---</p> 	<p>--- ---</p> <p>NON DISPONIBILE NOT AVAILABLE</p>

I ricambi non sono originali ma adattabili . Ogni riferimento originale é assolutamente indicativo .
Spare parts are not original but perfectly suitable . Every original part number has to be considered for reference purpose only .

SUITABLE





VOLVO

AUTOCARRI - CAMIONS - TRUCKS - LKW

Tel:+44(0)1925 850082 Fax: +(0)44 1925 850083

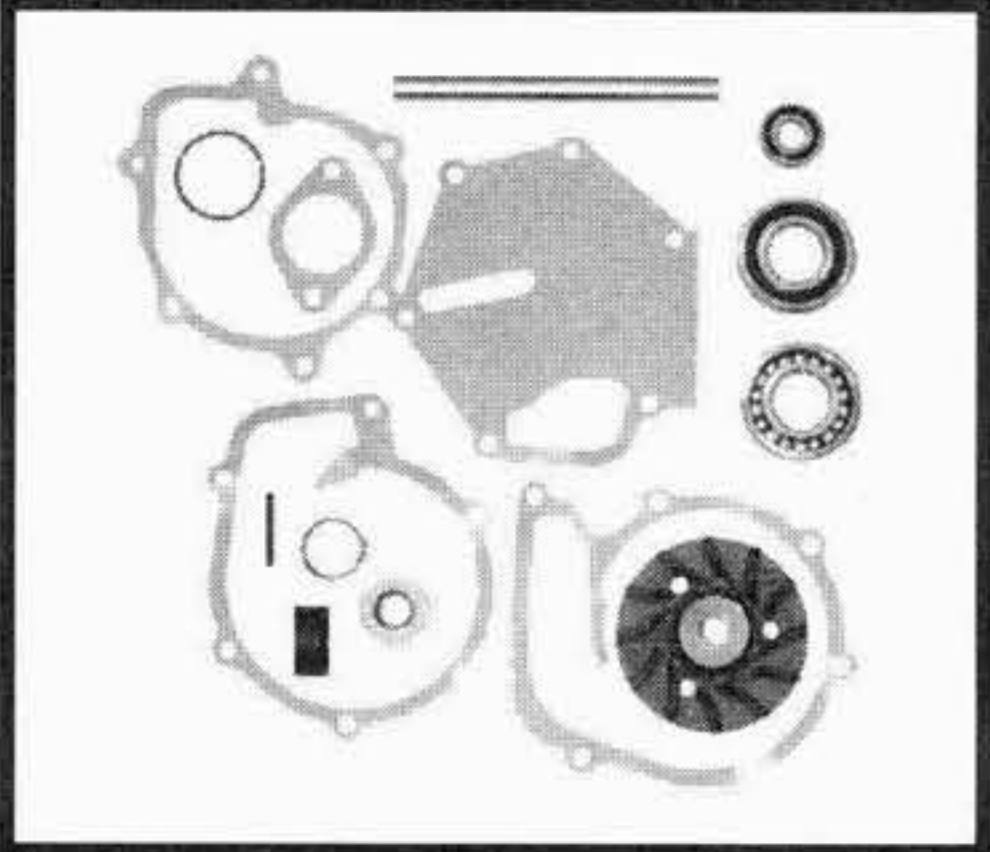
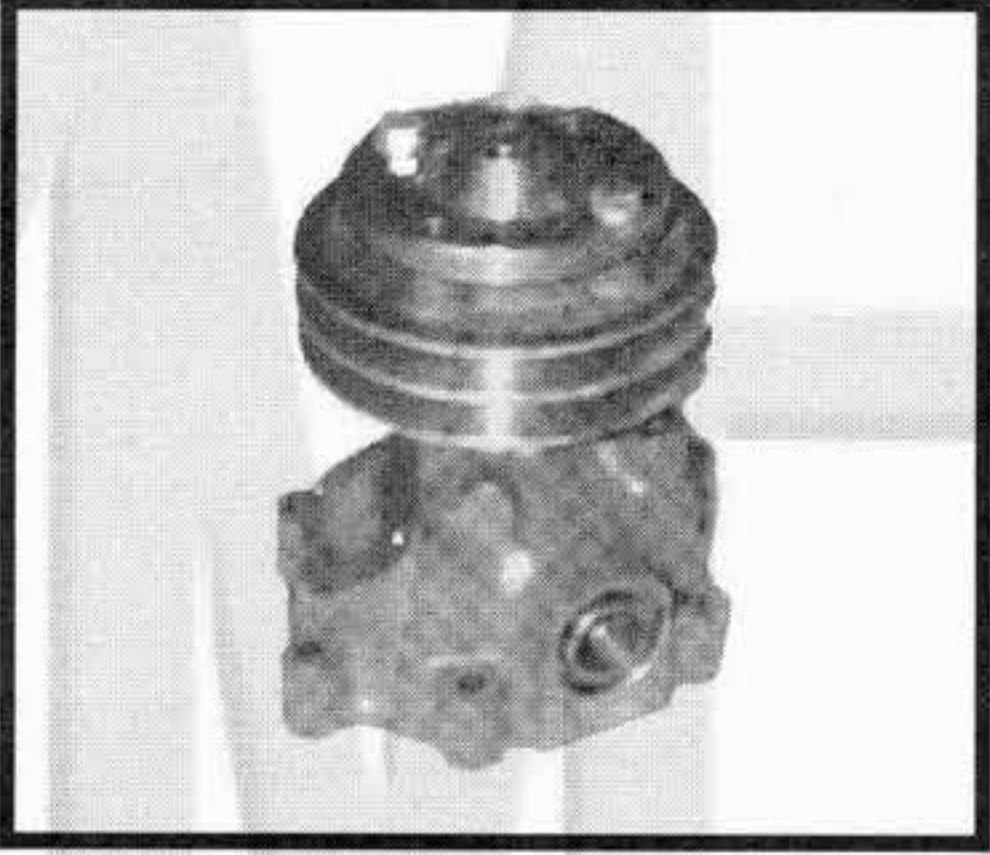
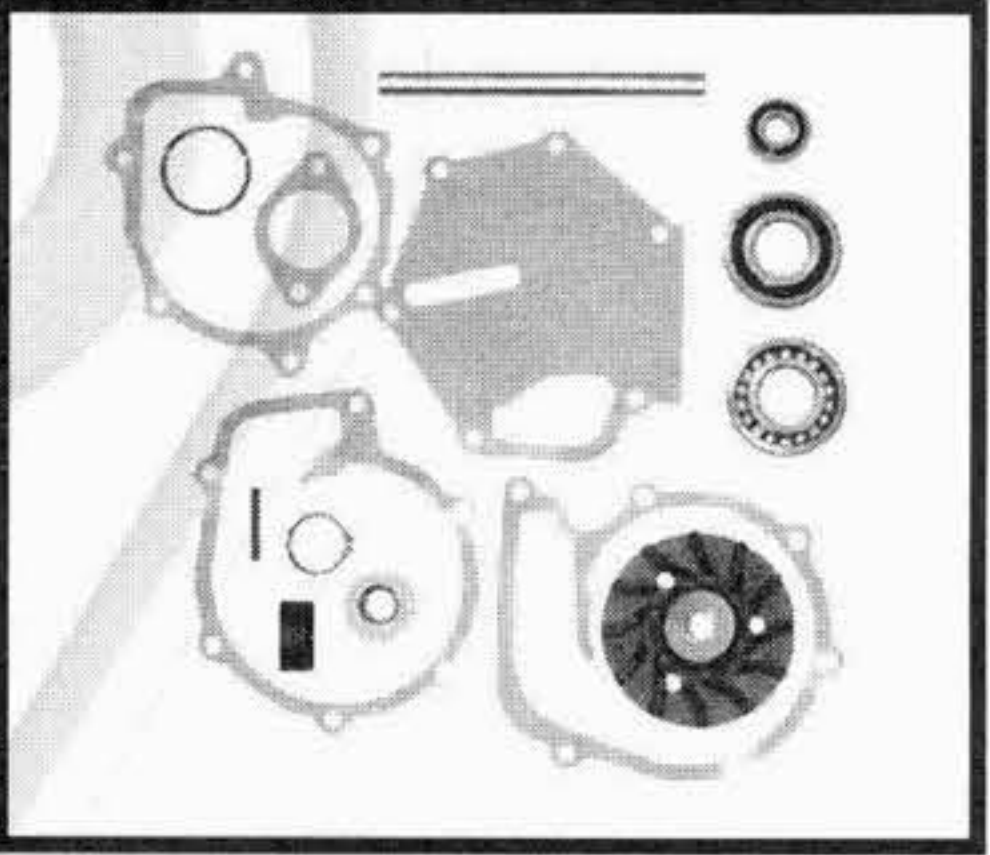
www.spwaterpumps.co.uk

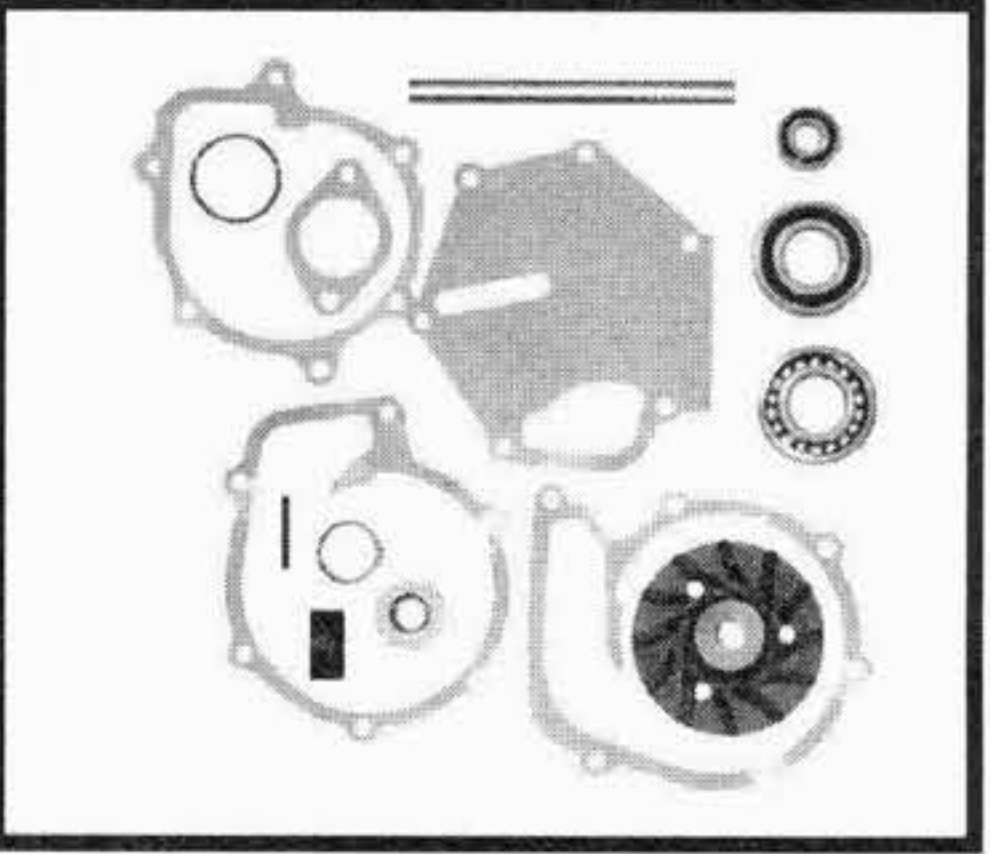

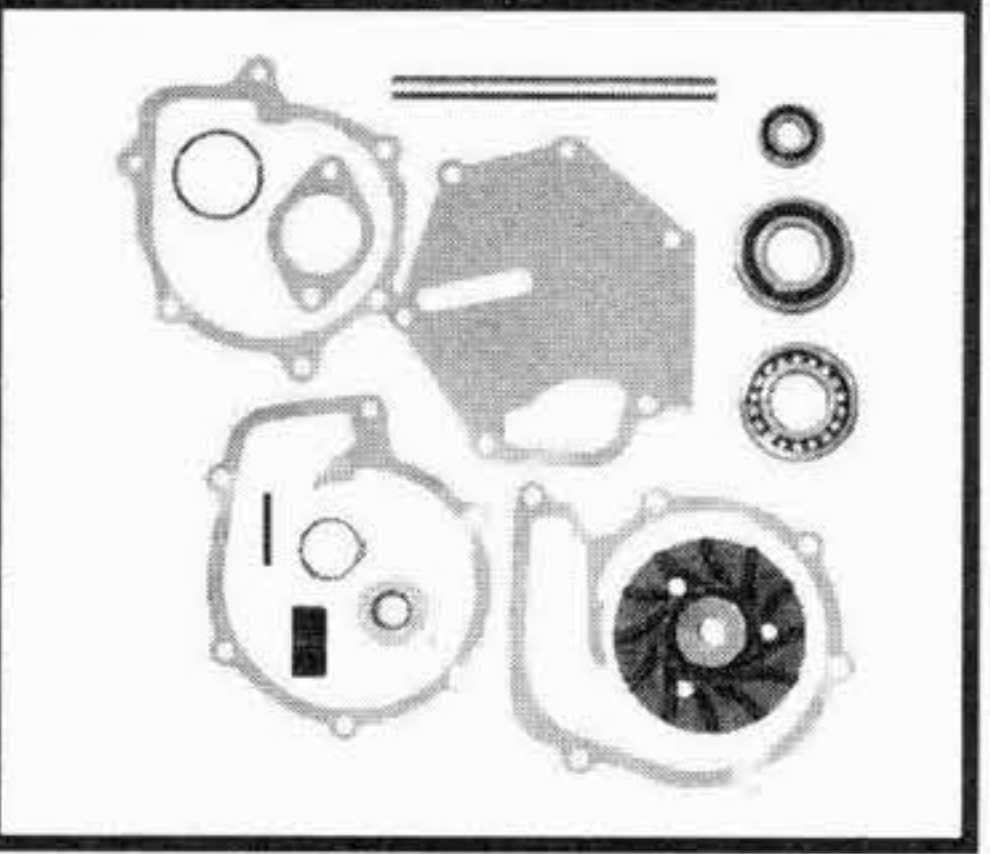
TIPO O MODELLO TYPE OU MODELE TYPE OR MODEL	MOTORE MOTEUR ENGINE	POMPA ACQUA POMPE A EAU WATER PUMP OMP REF. / O.EM. REF	KIT RIPARAZIONE NECESSAIRE DE REP. REPAIR KIT OMP REF. / O.EM. REF
F 6 07 / 08 / 09 / 10 / 11 / 11 USA 12 / 13 / 13 USA / 14 / 14 USA F 84 N 84 F 85	D 60 TD 60 A TD 60 B TD 60 C TD 60 A USA TD 60 B USA	<p>317.040 465.242</p> 	<p>312.275 276.806</p>  <p>in alternativa / alternatively use 312.170 275.607</p>
F 6 S F 6 15 / 16 / 17 F 84 N 84 F 85	TD 60 A TD 60 B	<p>317.110 1699.783</p> 	<p>312.275 276.806</p>  <p>in alternativa / alternatively use 312.170 275.607</p>
F 7 F 86 - N 86 FB 86 F 87 N 87	TD 70 F TD 70 FC TD 70 FS TD 70 F USA TD 70 G TD 70 A TD 70 B TD 70 D TD 70 E	<p>317.000 1699.784</p> 	<p>312.275 276.806</p>  <p>in alternativa / alternatively use 312.170 275.607</p>
N 7 F 86 FB 86 F 87 N 87	TD 70 B TD 70 E TD 70 G TD 70 F TD 70 G	<p>317.030 466.088</p> 	<p>312.275 276.806</p>  <p>in alternativa / alternatively use 312.170 275.607</p>

I ricambi non sono originali ma adattabili . Ogni riferimento originale é assolutamente indicativo .
Spare parts are not original but perfectly suitable . Every original part number has to be considered for reference purpose only .

SUITABLE





VOLVO

AUTOCARRI - CAMIONS - TRUCKS - LKW

Tel:+44(0)1925 850082 Fax: +(0)44 1925 850083

www.spwaterpumps.co.uk

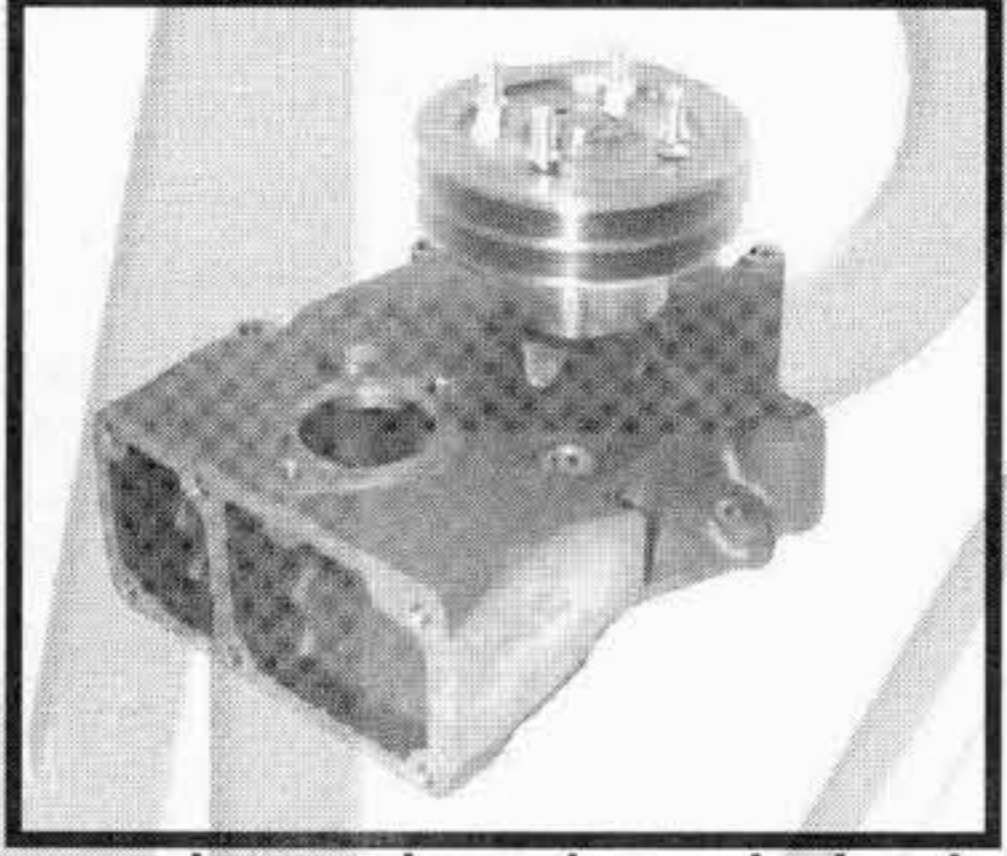

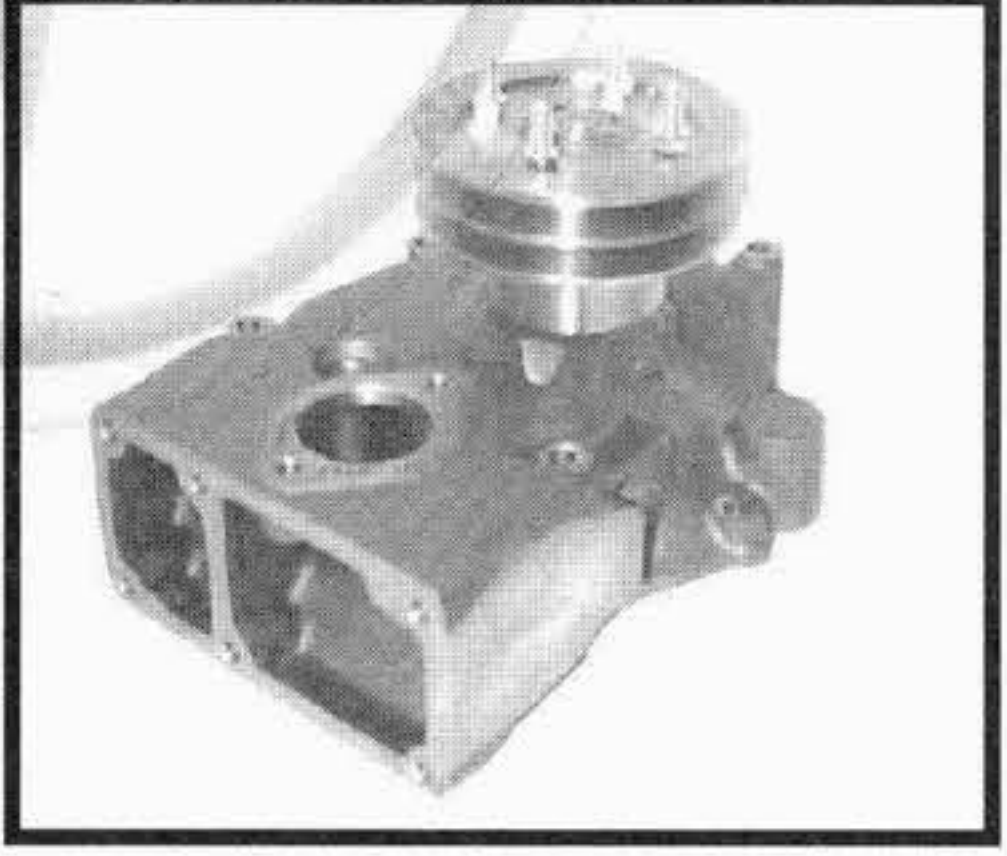
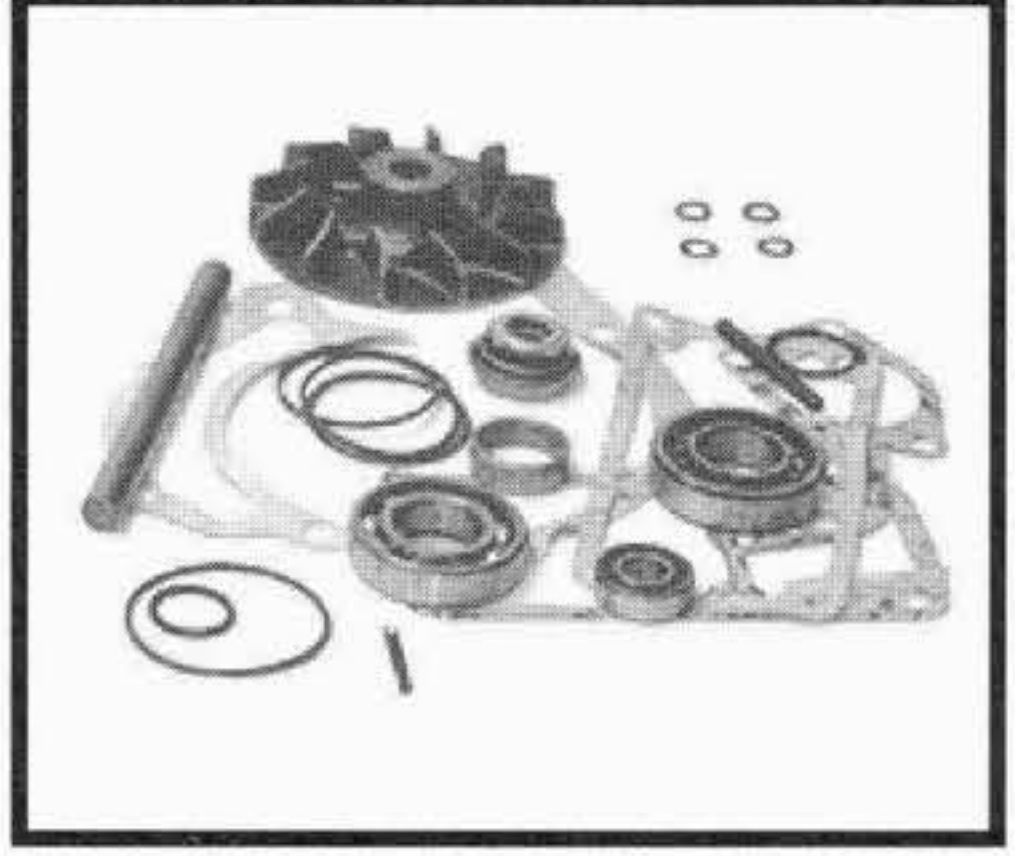
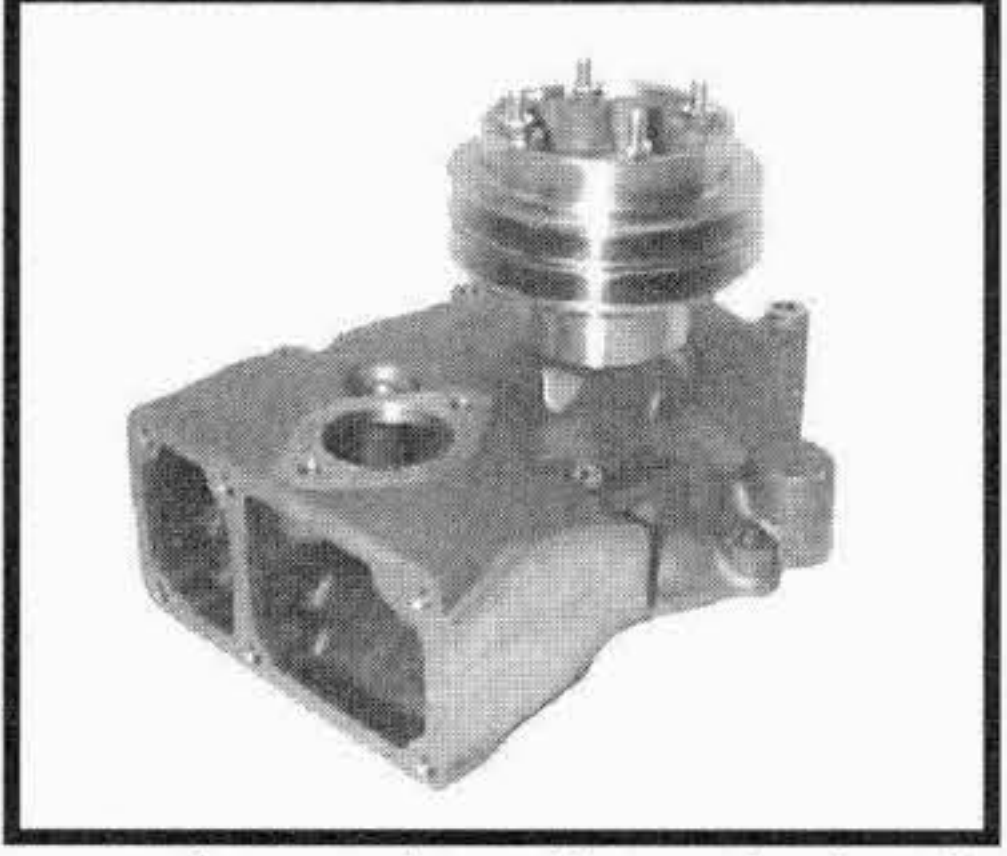
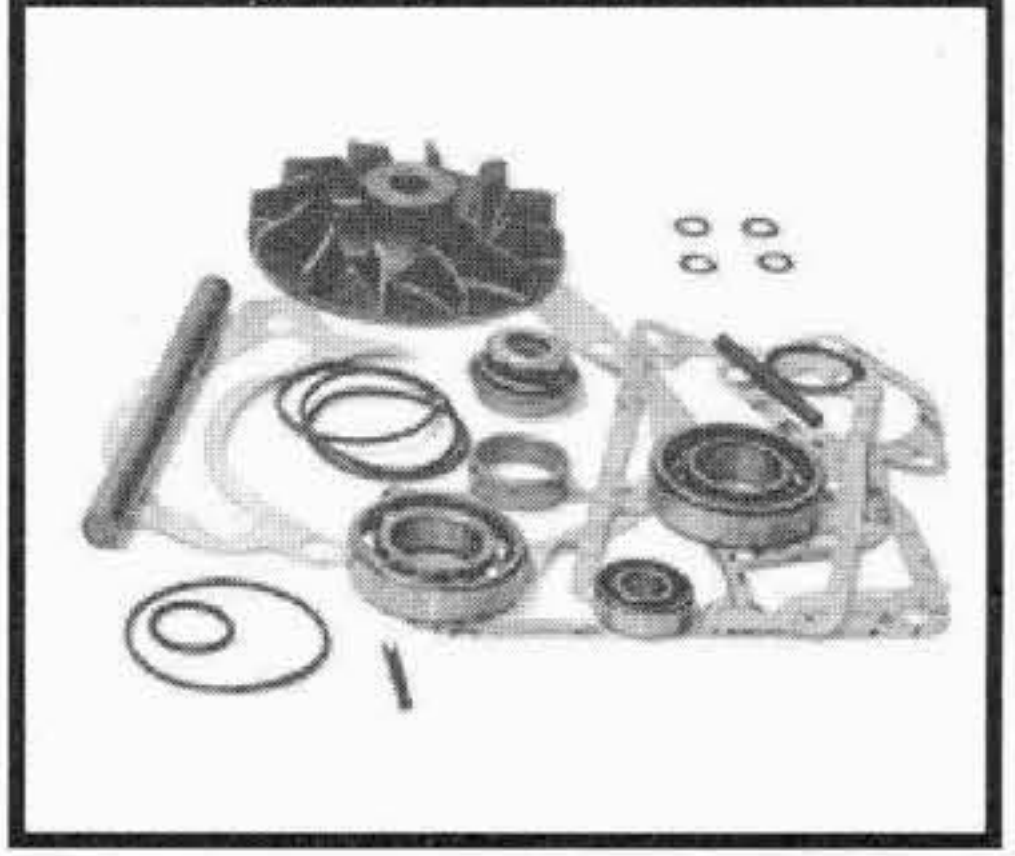
TIPO O MODELLO TYPE OU MODELE TYPE OR MODEL	MOTORE MOTEUR ENGINE	POMPA ACQUA POMPE A EAU WATER PUMP OMP REF. / O.EM. REF	KIT RIPARAZIONE NECESSAIRE DE REP. REPAIR KIT OMP REF. / O.EM. REF
FE 6 FL 6 FL 6 FE 7 FL 7 FS 7 FL 7 FS 7 WHITE	TD 61 TD 63 D 6 TD 71 TD 73 D 7	<p>317.175 8192.050</p> 	<p>312.277 276.835</p> 
F 10 ---> fino al telaio 25000	TD 100 A TD 100 B TD 100 BG TD 100 GA	<p>317.060 467.906</p>  ad esaurimento sost. da / will be supersided by <p>317.215 1699.785</p>	<p>312.172 275.618</p>  in alternativa / alternatively use <p>312.285 276.800</p>
F 10 ---> fino al telaio 25000 NEW !!	TD 100 A TD 100 B TD 100 BG TD 100 GA	<p>317.215 1699.785</p> 	<p>312.285 276.800</p>  in alternativa / alternatively use <p>312.172 275.618</p>
F 10 dal telaio 25001 ---> ---> fino al telaio 314000	TD 101 G TD 101 GA	<p>317.170 1545.246</p>  ad esaurimento sost. da / will be supersided by <p>317.220 1698.617</p>	<p>312.285 276.800</p>  in alternativa / alternatively use <p>312.172 275.618</p>





I ricambi non sono originali ma adattabili . Ogni riferimento originale é assolutamente indicativo .
 Spare parts are not original but perfectly suitable . Every original part number has to be considered for reference purpose only .

SUITABLE

VOLVO

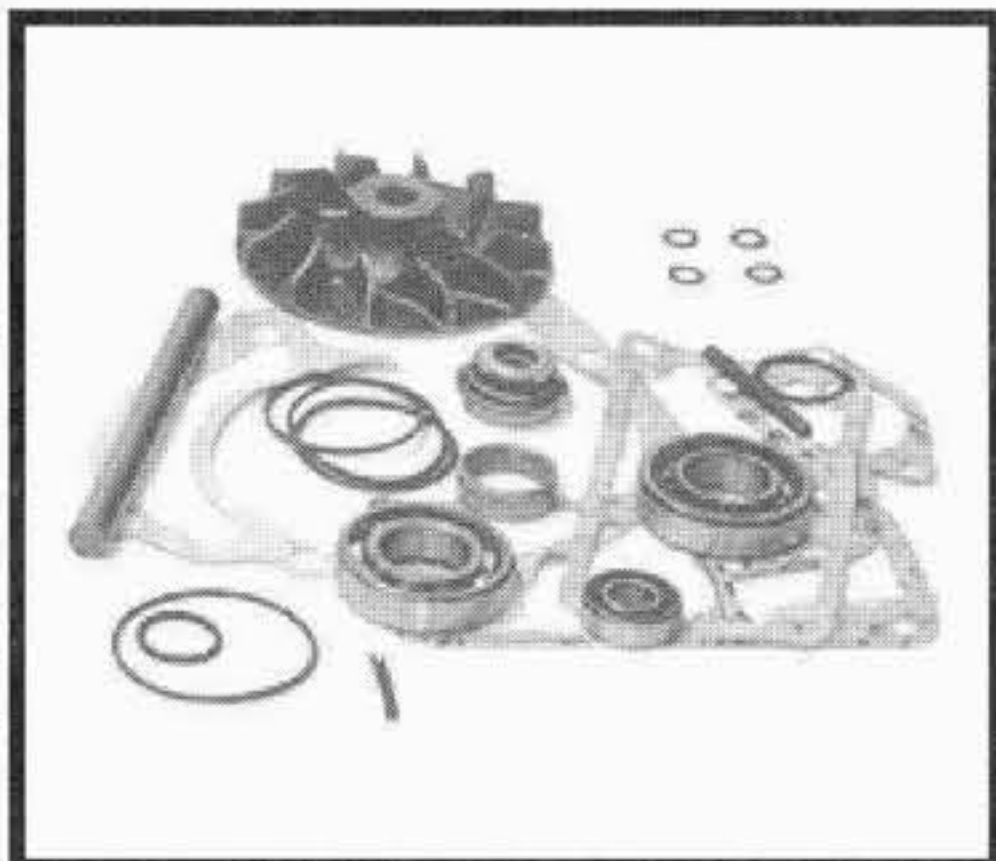
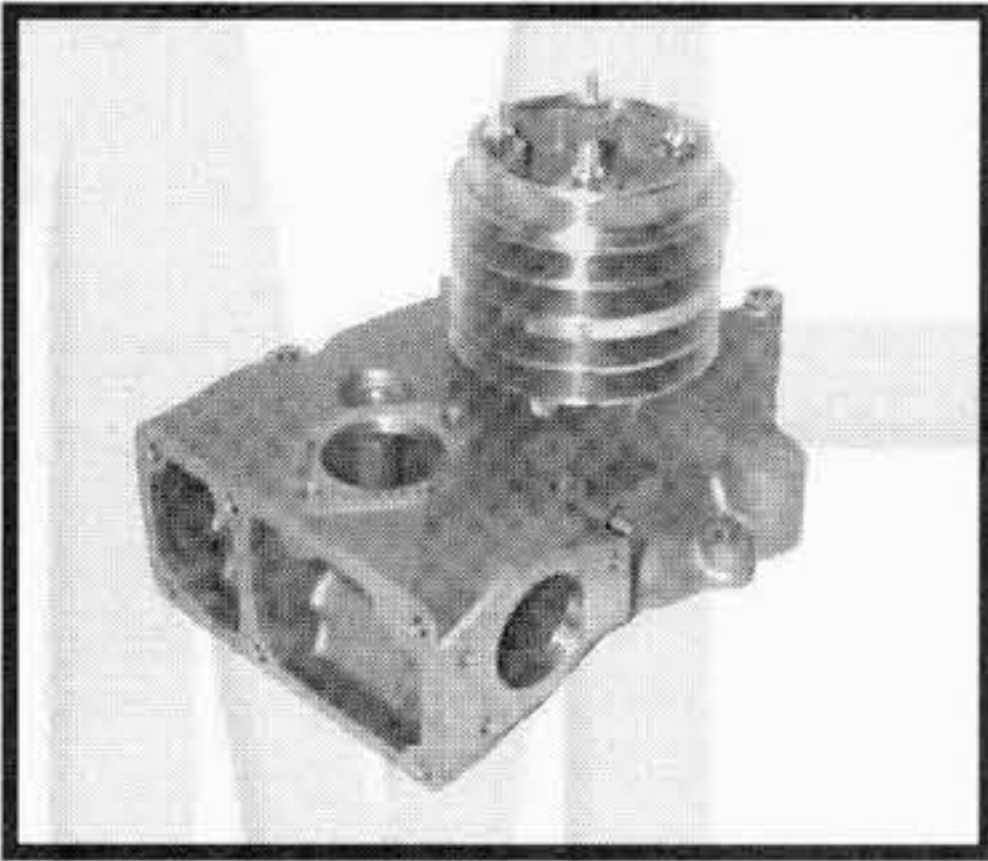
AUTOCARRI - CAMIONS - TRUCKS - LKW
Tel:+44(0)1925 850082 Fax: +(0)44 1925 850083
www.spwaterpumps.co.uk

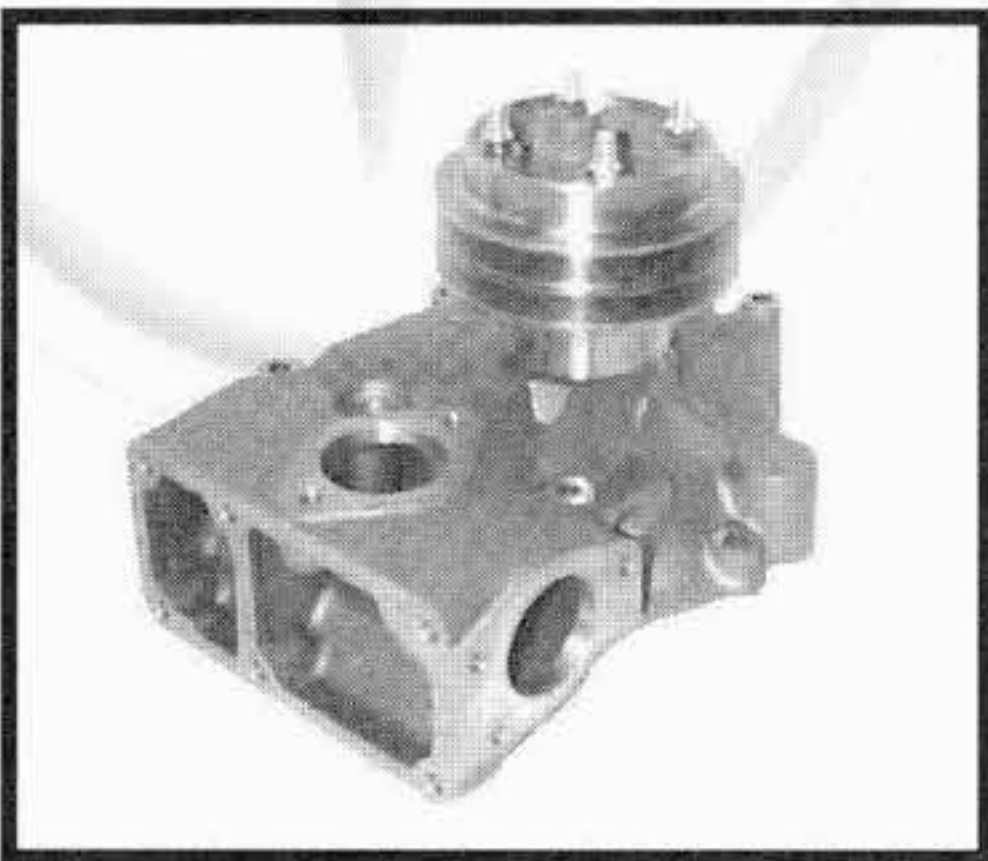
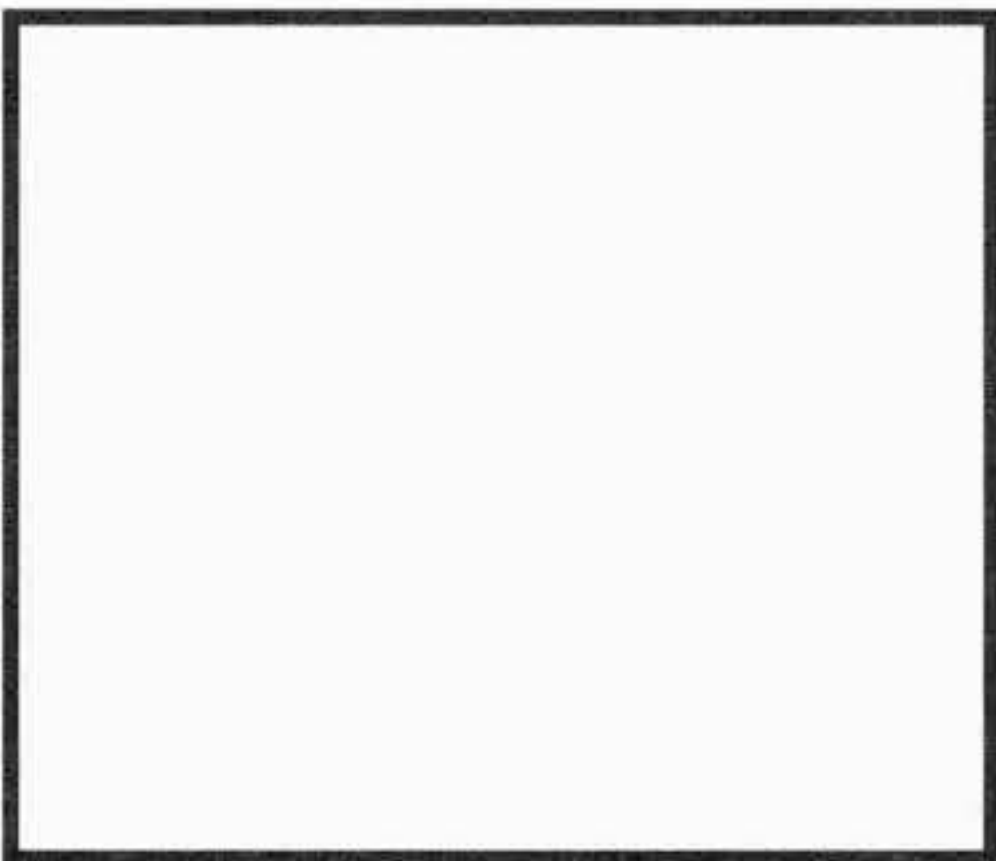

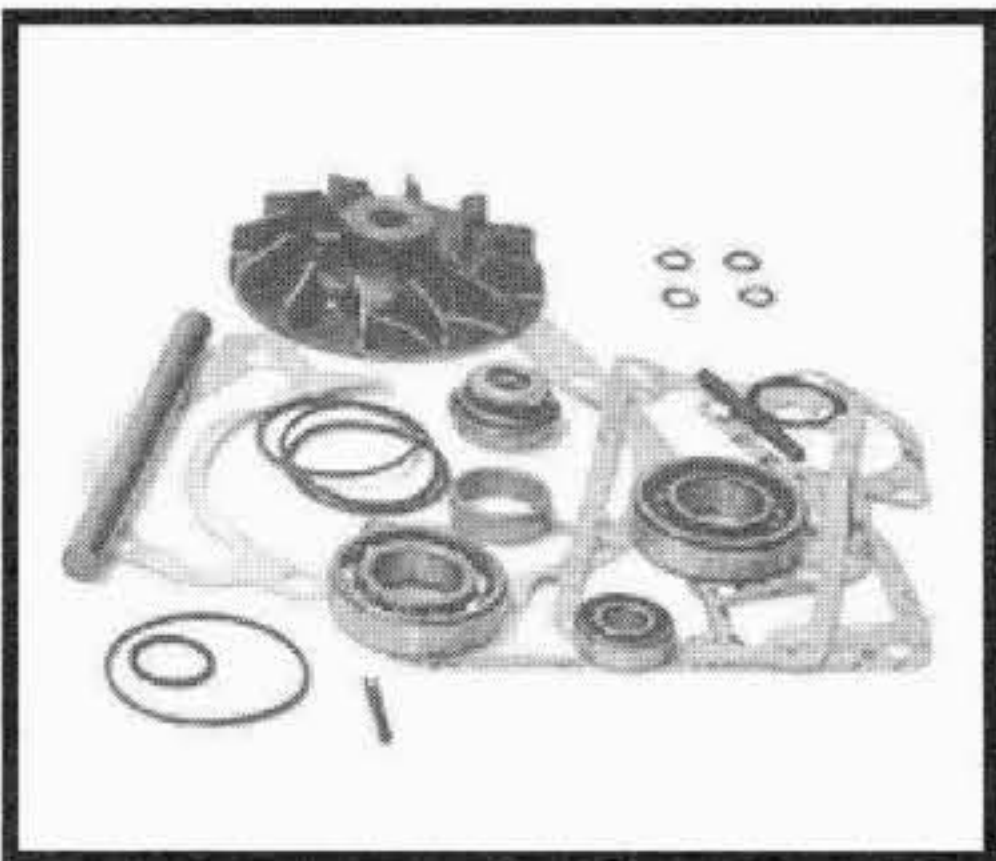
TIPO O MODELLO TYPE OU MODELE TYPE OR MODEL	MOTORE MOTEUR ENGINE	POMPA ACQUA POMPE A EAU WATER PUMP	OMP REF. / O.EM. REF	KIT RIPARAZIONE NECESSAIRE DE REP. REPAIR KIT	OMP REF. / O.EM. REF
F 10 dal telaio 25001 ---> ---> fino al telaio 314000 F 10 INTERCOOLER dal telaio 314001 --->	TD 101 G TD 101 GA TD 102 TD 103	317.220 1698.617 		312.285 276.800  in alternativa / alternatively use 312.172 275.618	
N 10 ---> fino al telaio 49000	TD 100 A	317.070 467.915  ad esaurimento sost. da / will be supersided by 317.225 1699.789		312.172 275.618  in alternativa / alternatively use 312.285 276.800	
N 10 ---> fino al telaio 49000 N 10 dal telaio 49001 --->	TD 100 B TD 100 BG TD 100 G TD 101 G	317.010 1545.248  ad esaurimento sost. da / will be supersided by 317.230 1699.788		312.172 275.618  in alternativa / alternatively use 312.285 276.800	
N 10 dal telaio 49001 ---> NL 10 NL 10 S N 10 MARK II	TD 102 TD 102 TD 102	317.230 1699.788 		312.285 276.800  in alternativa / alternatively use 312.172 275.618	

I ricambi non sono originali ma adattabili . Ogni riferimento originale é assolutamente indicativo .





Spare parts are not original but perfectly suitable . Every original part number has to be considered for reference purpose only .

SUITABLE

VOLVO

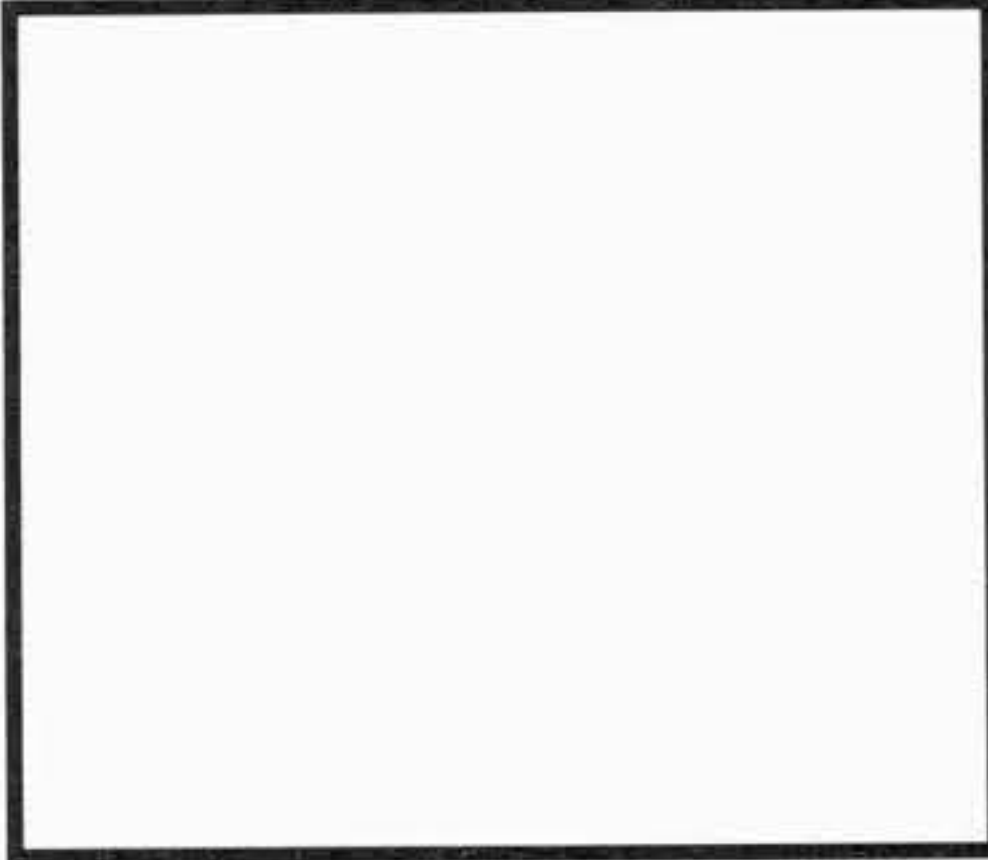
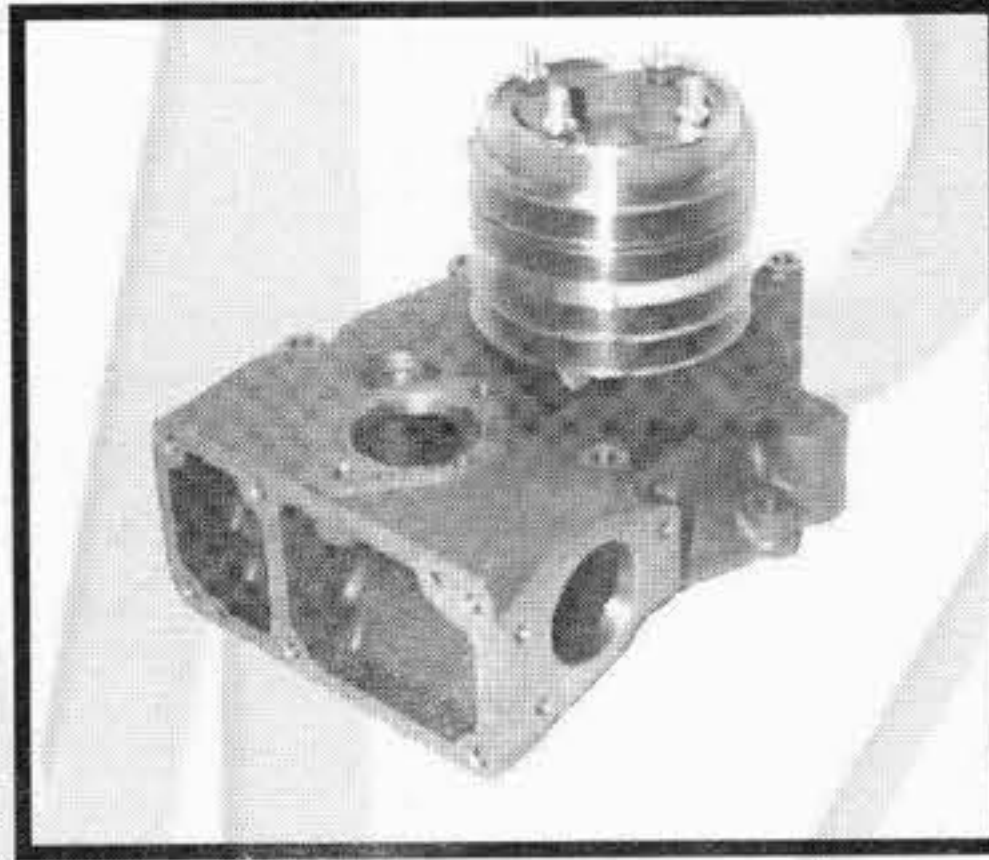
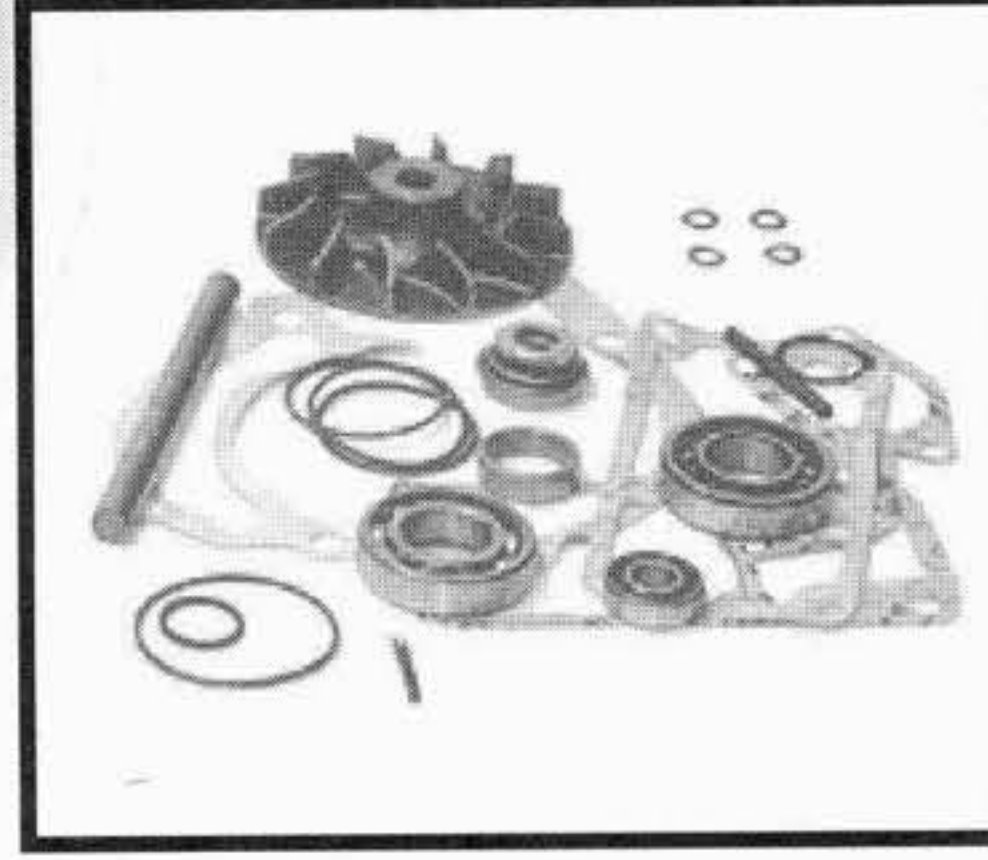
AUTOCARRI - CAMIONS - TRUCKS - LKW
Tel:+44(0)1925 850082 Fax: +(0)44 1925 850083
www.spwaterpumps.co.uk

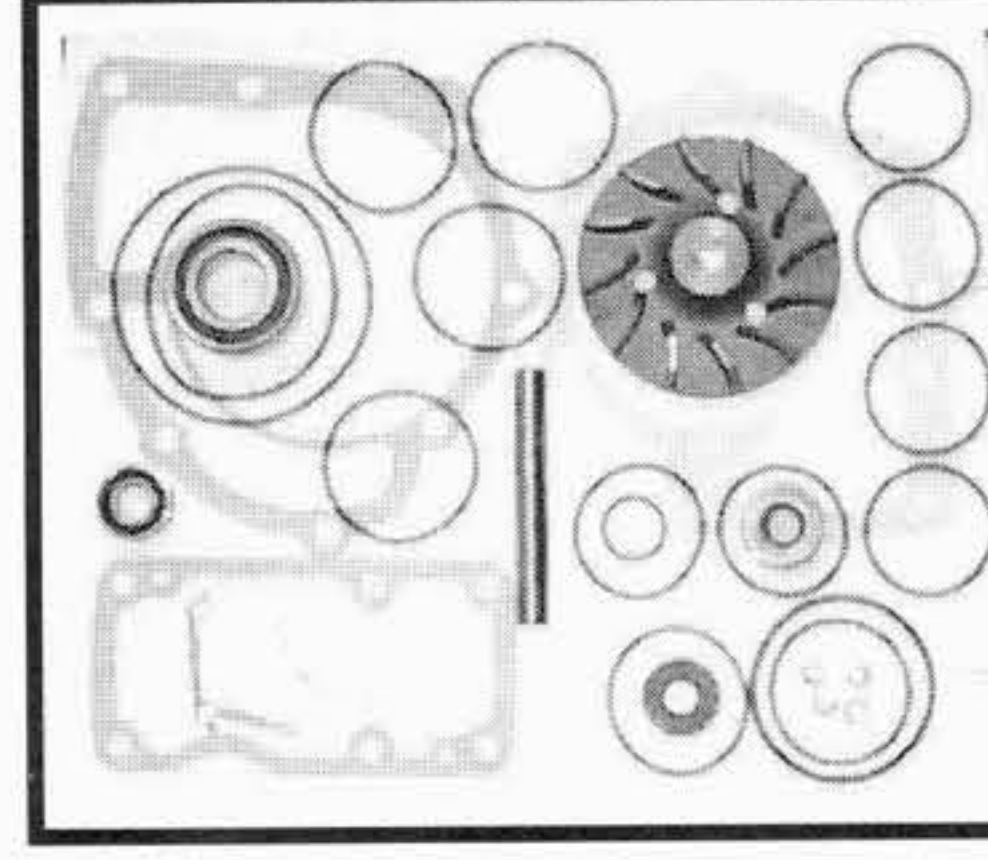

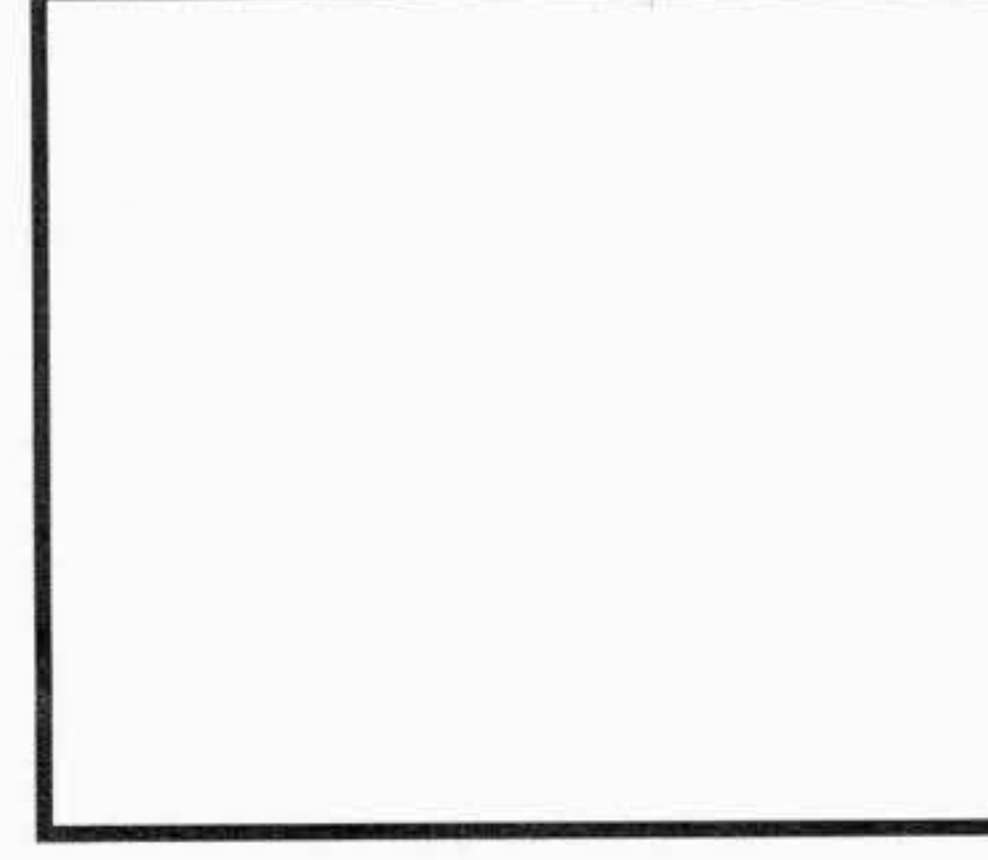



TIPO O MODELLO TYPE OU MODELE TYPE OR MODEL	MOTORE MOTEUR ENGINE	POMPA ACQUA POMPE A EAU WATER PUMP OMP REF. / O.EM. REF	KIT RIPARAZIONE NECESSAIRE DE REP. REPAIR KIT OMP REF. / O.EM. REF
<p>N 10 dal telaio 304000 ---></p> <p>NL 10 S dal telaio 304000 ---></p> <p>N 10 MARK II dal telaio 304000 ---></p>	<p>TD 101 USA</p> <p>TD 101 USA</p> <p>TD 101 USA</p>	<p>317.195 1545.427</p>  <p>ad esaurimento sost. da / will be superseded by 317.225 1699.789</p>	<p>312.178 275.986</p>  <p>in alternativa / alternatively use 312.285 276.800</p>
<p>N 10 dal telaio 304000 ---></p> <p>NL 10 - NL 10 S dal telaio 304000 ---></p> <p>N 10 MARK II dal telaio 304000 ---></p>	<p>TD 101 USA</p> <p>TD 101 USA</p> <p>TD 101 USA</p>	<p>317.225 1699.789</p> 	<p>312.285 276.800</p>  <p>in alternativa / alternatively use 312.172 275.618</p>
<p>F 10 dal telaio 25001 ---></p> <p>FL 10 INTERCOOLER 320</p> <p>FL 10</p> <p>FS 10</p> <p>F 12 ---> fino al telaio 34000</p> <p>F 12 dal telaio 34001 ---></p> <p>F 12 INTERCOOLER 360 dal telaio 314000 ---></p> <p>F 12 INTERCOOLER 420</p> <p>N 12 ---> fino al telaio 12000</p> <p>N 12 dal telaio 12001 ---></p> <p>NL 10 S</p> <p>NL 12 - NL 12 S</p>	<p>TD 101 F</p> <p>TD 102 F</p> <p>TD 101 F</p> <p>TD 102 F</p> <p>TD 120 C/D/E/F/FC/G/GA</p> <p>TD 121 F/FD/G/GD</p> <p>TD 122 FK / FS</p> <p>TD 120 A/E/G/GA</p> <p>TD 121 F/G/GA</p> <p>TD 121 GA</p> <p>TD 122 FK / FS</p>	<p>317.160 1545.261</p> 	<p>312.276 276.802</p>  <p>in alternativa / alternatively use 312.171 275.615</p>
<p>F 10 INTERCOOLER 320</p> <p>F 12 INTERCOOLER 360</p> <p>F 12 INTERCOOLER 420</p>	<p>TD 102 F - OCS</p> <p>TD 122 FK/FS-OCS</p> <p>TD 122 FK/FS-OCS</p>	<p>317.190 422.791</p> 	<p>312.175 270.791</p> 

NEW !!

I ricambi non sono originali ma adattabili . Ogni riferimento originale é assolutamente indicativo .
 Spare parts are not original but perfectly suitable . Every original part number has to be considered for reference purpose only .

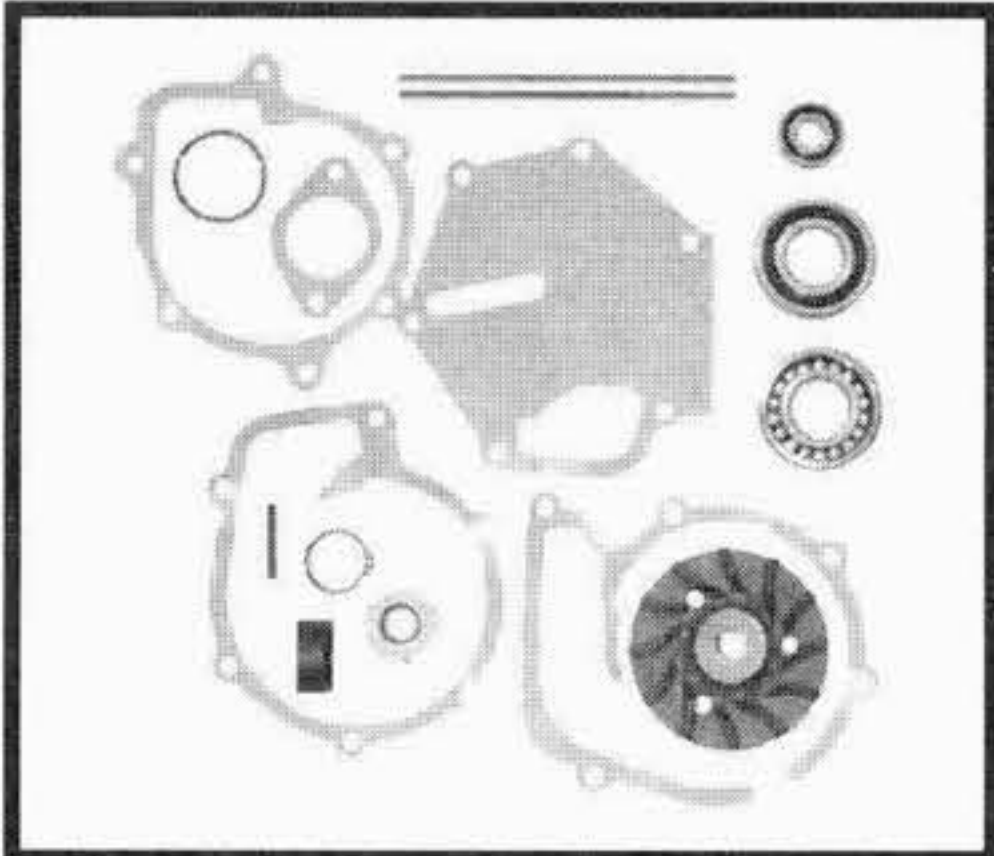
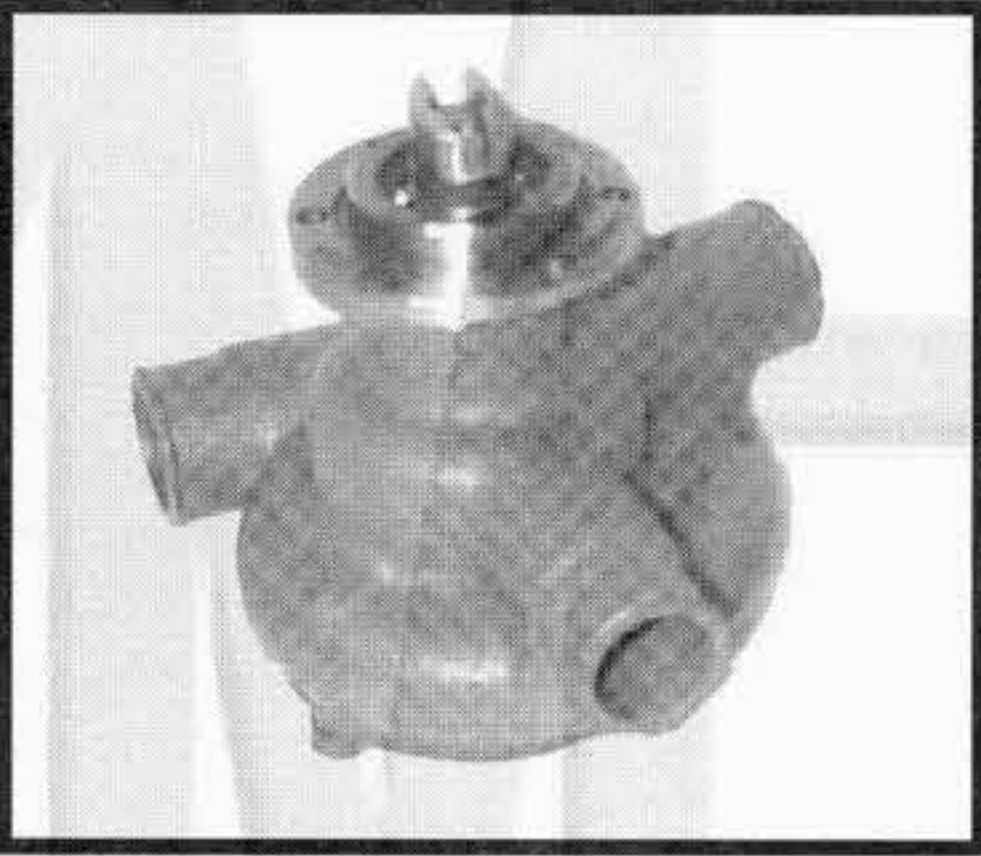
SUITABLE

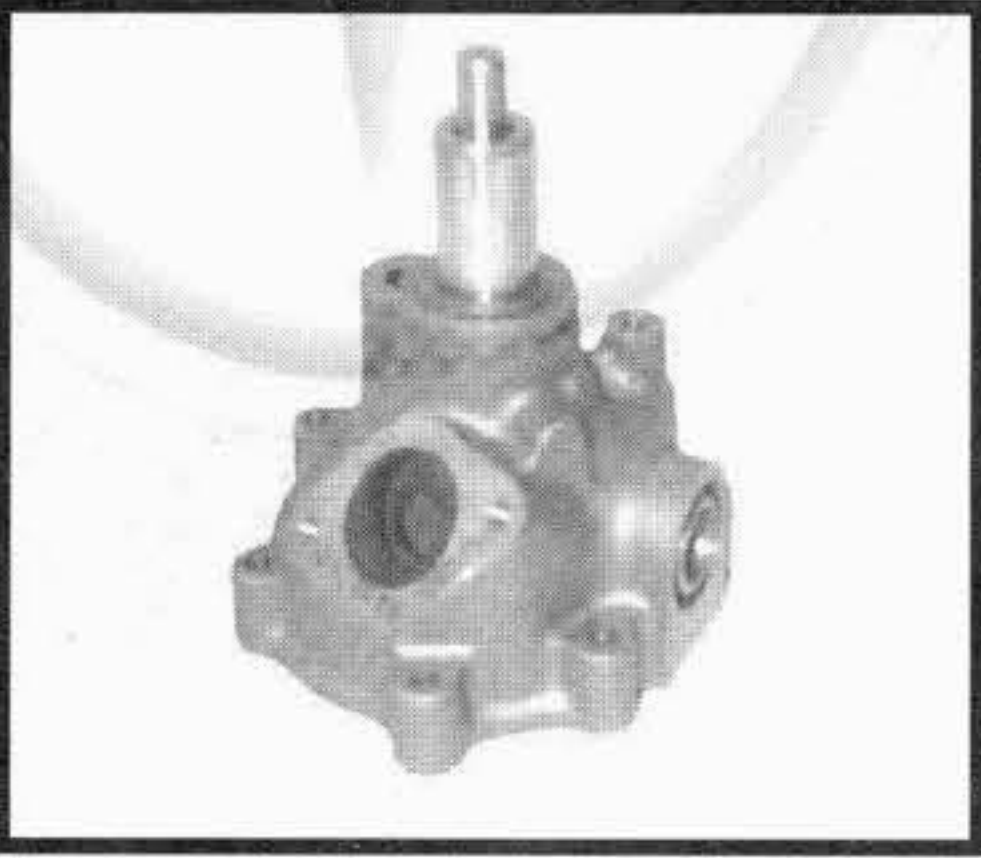
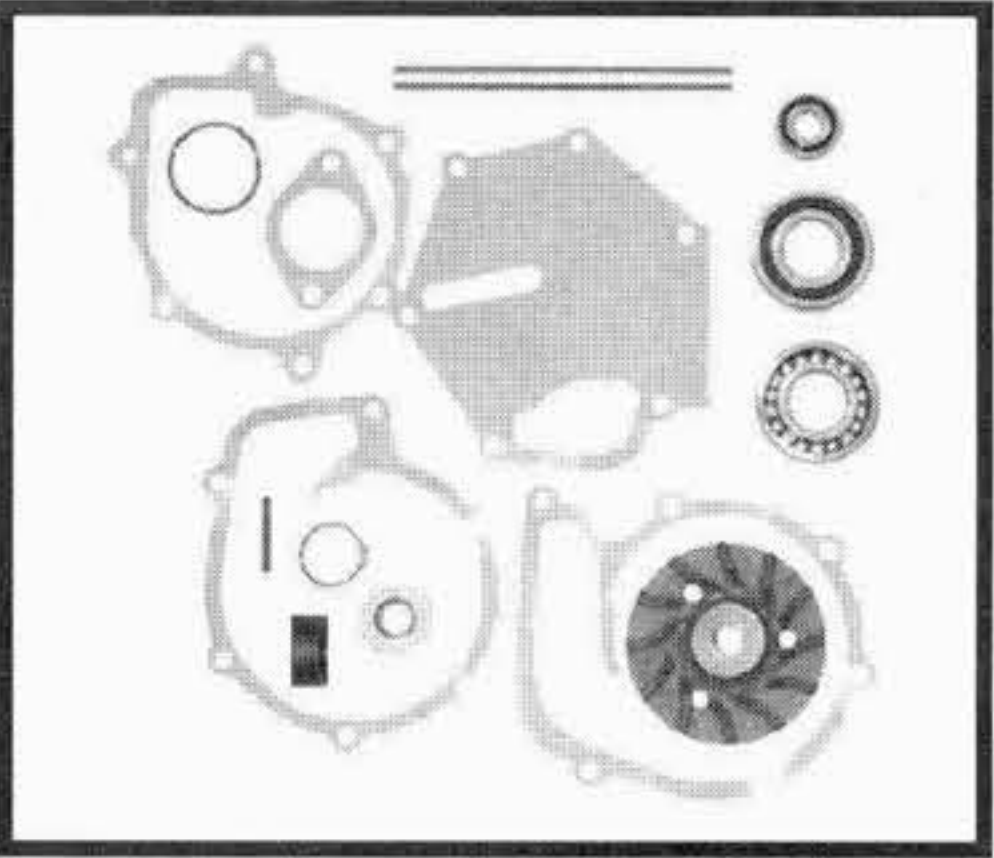
VOLVO**AUTOBUS - AUTOCARS - BUSES - OMNIBUSSE****Tel:+44(0)1925 850082 Fax: +(0)44 1925 850083****www.spwaterpumps.co.uk****SP WATER PUMPS**

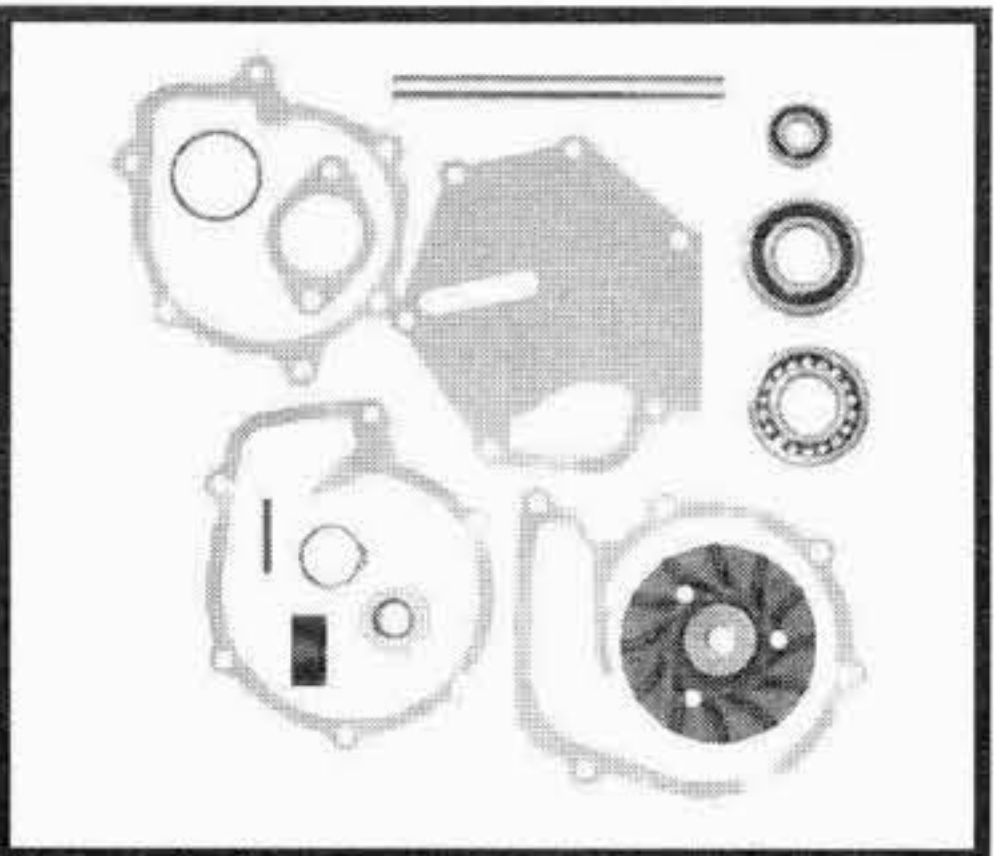
TIPO O MODELLO TYPE OU MODELE TYPE OR MODEL	MOTORE MOTEUR ENGINE	POMPA ACQUA POMPE A EAU WATER PUMP	KIT RIPARAZIONE NECESSAIRE DE REP. REPAIR KIT
B 57	TD 70 F TD 70 FC TD 70 FS TD 70 F USA TD 70 G	<p>317.000 1699.784</p> 	<p>312.275 276.806</p>  <p>in alternativa / alternatively use 312.170 275.607</p>
B 58 B 59 B 9 M B 10 M B 10 R	HD 100 A THD 100 AD	<p>317.080 1699.781</p> 	<p>312.286 3097.204</p>  <p>n alternativa / alternatively use 312.173 275.609</p>
B 6	D 60 TD 60 A TD 60 B TD 60 C TD 60 A USA TD 60 B USA	<p>317.040 465.242</p> 	<p>312.275 276.806</p>  <p>in alternativa / alternatively use 312.170 275.607</p>
B 6	TD 60 A TD 60 B	<p>317.110 1699.783</p> 	<p>312.275 276.806</p>  <p>in alternativa / alternatively use 312.170 275.607</p>

I ricambi non sono originali ma adattabili . Ogni riferimento originale é assolutamente indicativo .
Spare parts are not original but perfectly suitable . Every original part number has to be considered for reference purpose only .

SUITABLE





VOLVO

AUTOBUS - AUTOCARS - BUSES - OMNIBUSSE

Tel:+44(0)1925 850082 Fax: +(0)44 1925 850083

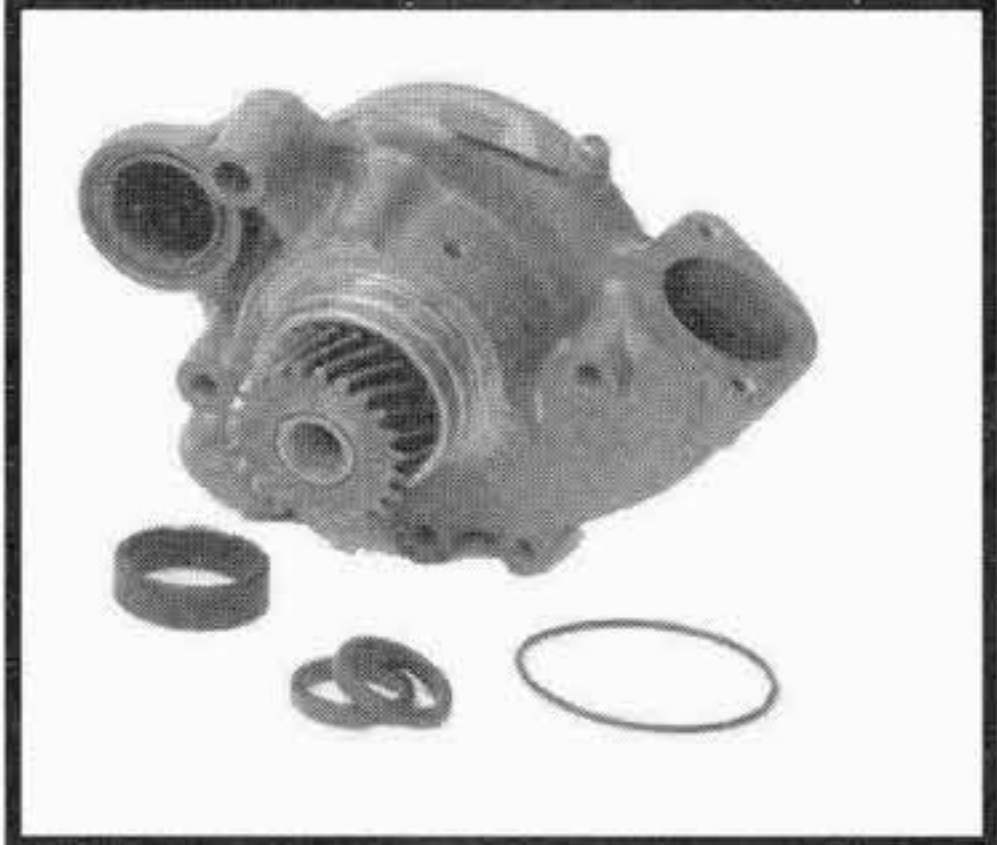
www.spwaterpumps.co.uk

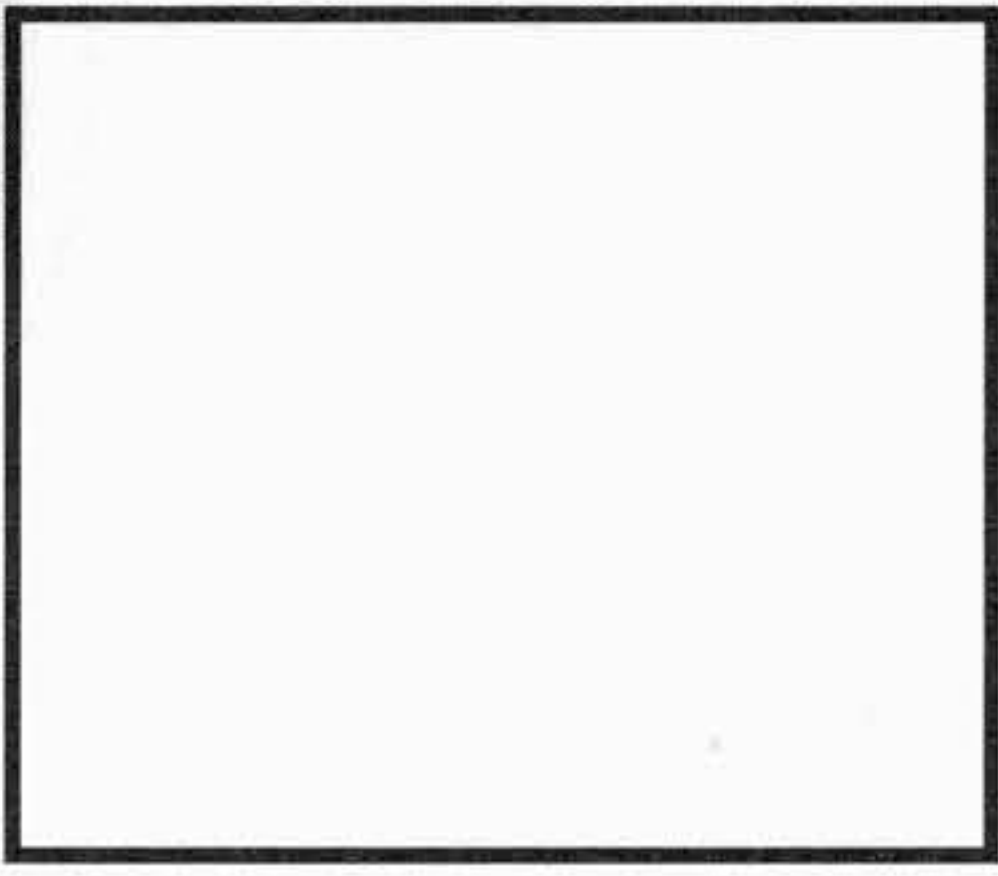

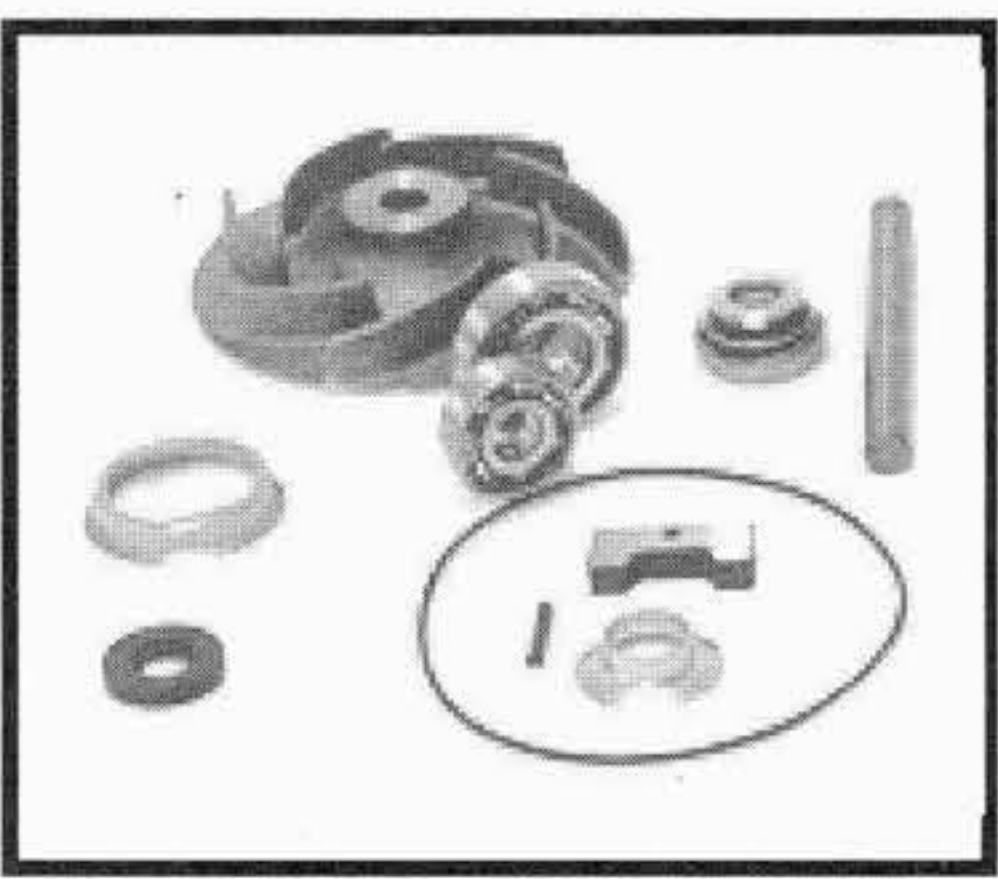
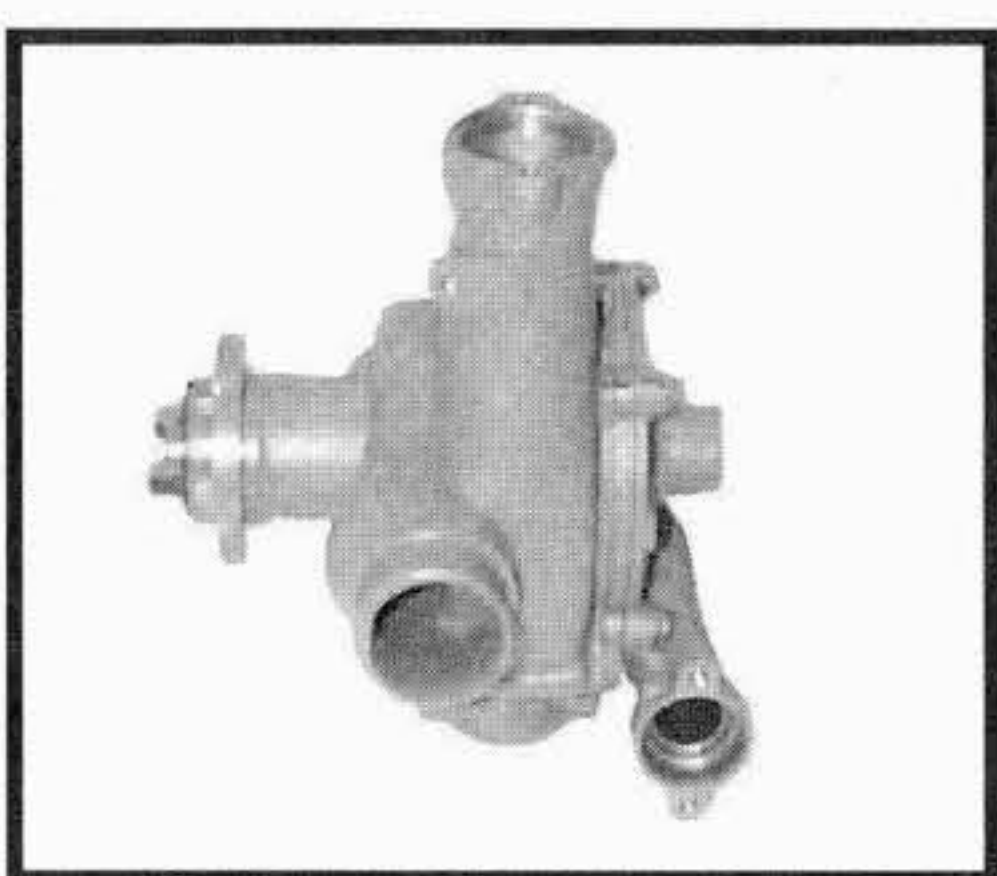
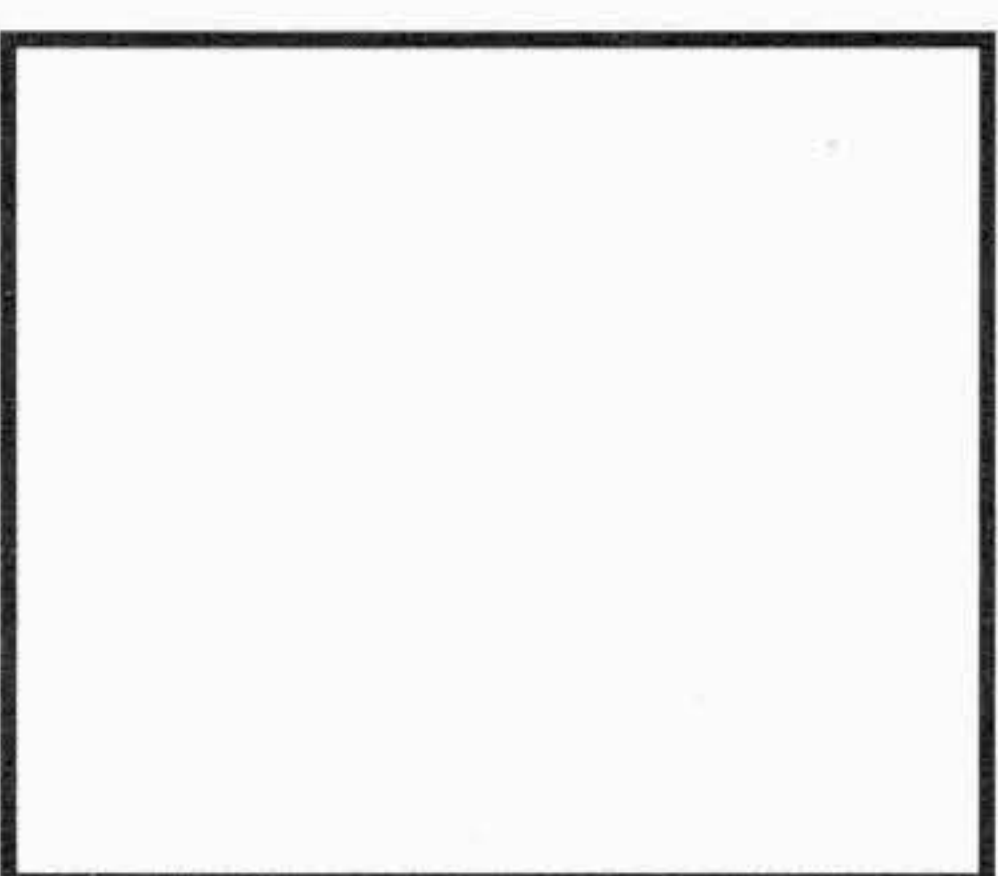
TIPO O MODELLO TYPE OU MODELE TYPE OR MODEL	MOTORE MOTEUR ENGINE	POMPA ACQUA POMPE A EAU WATER PUMP	KIT RIPARAZIONE NECESSAIRE DE REP. REPAIR KIT
<p>B 6</p> <p>B 6 Excellence 1000 Midi</p> <p>B 6 Midi</p> <p>B 6 - SN9</p> <hr/> <p>B 7 dal telaio n° 30000 ---></p> <p>317.350 - FM7 Buses B6, B7, B7L, B7R. TD73 High Output</p>	<p>TD 63 E</p> <p>D 6</p> <p>TD 73</p>	<p>317.175 8192.050</p>  <p>High Output Version 317.350 - FM7, B7L etc</p>	<p>312.277 276.835</p> 
<p>B 9 M</p> <p>B 10 M --> fino al telaio 20000</p> <p>B 10 R</p> <p>C 10 M</p>	<p>THD 101 G --> mot. 50984 THD 101 K</p>	<p>--- 469.744</p> <div style="border: 1px solid black; padding: 10px; text-align: center;"> <p>SOST. DA : / REPLACE BY :</p> <p>317.180 425.308</p> </div>	<p>312.174 275.623</p> 
<p>B 9 M</p> <p>B 10 M --> fino al telaio 20000</p> <p>B 10 R</p> <p>B 10 B</p> <p>C 10 M</p> <p>B 10 M dal telaio 20001 ---></p> <p>B 10 R</p>	<p>THD 101 G mot. 50985 ---> THD 101 K</p> <p>THD 101 G</p>	<p>317.180 425.308</p> 	<p>312.287 3097.203</p> 
<p>B 9 M</p> <p>B 10 B</p> <p>B 10 M dal telaio 20001 ---></p> <p>B 10 R</p> <p>C 10 M</p> <p>NEW !!</p>	<p>THD 101 KE</p>	<p>317.280 425.267</p> 	<p>312.294 3097.084</p> 

I ricambi non sono originali ma adattabili . Ogni riferimento originale é assolutamente indicativo .
Spare parts are not original but perfectly suitable . Every original part number has to be considered for reference purpose only .

SUITABLE



VOLVO

AUTOBUS - AUTOCARS - BUSES - OMNIBUSSE

Tel:+44(0)1925 850082 Fax: +(0)44 1925 850083

www.spwaterpumps.co.uk

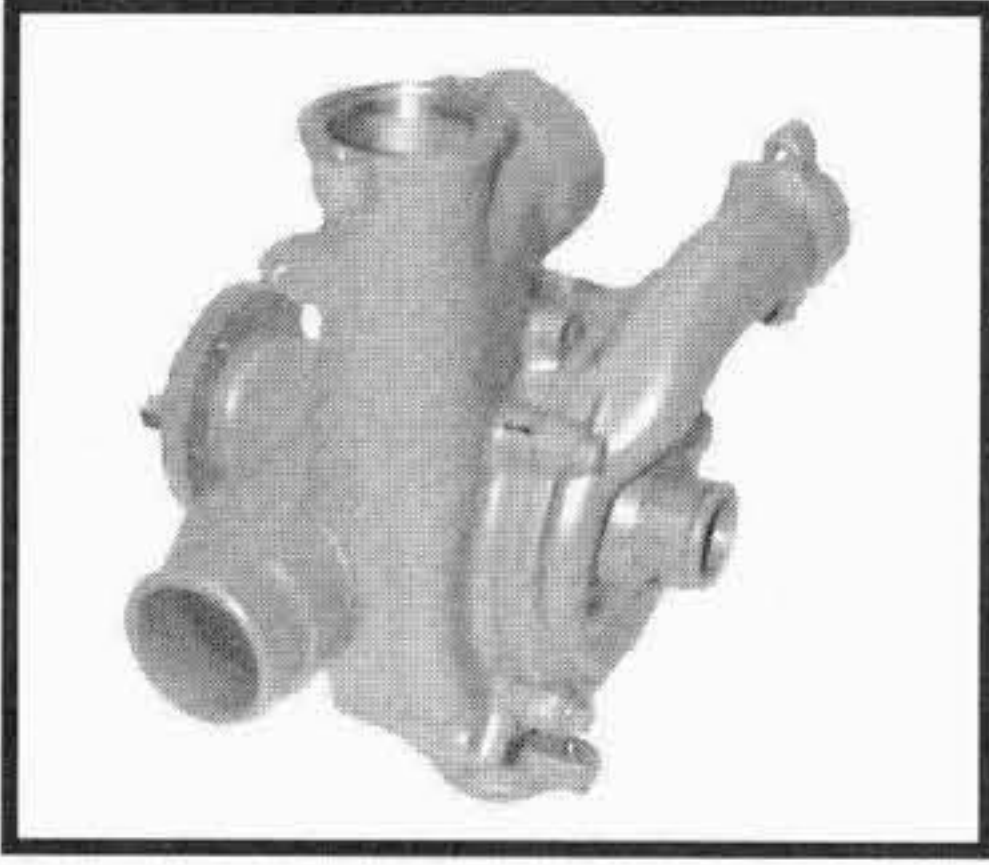
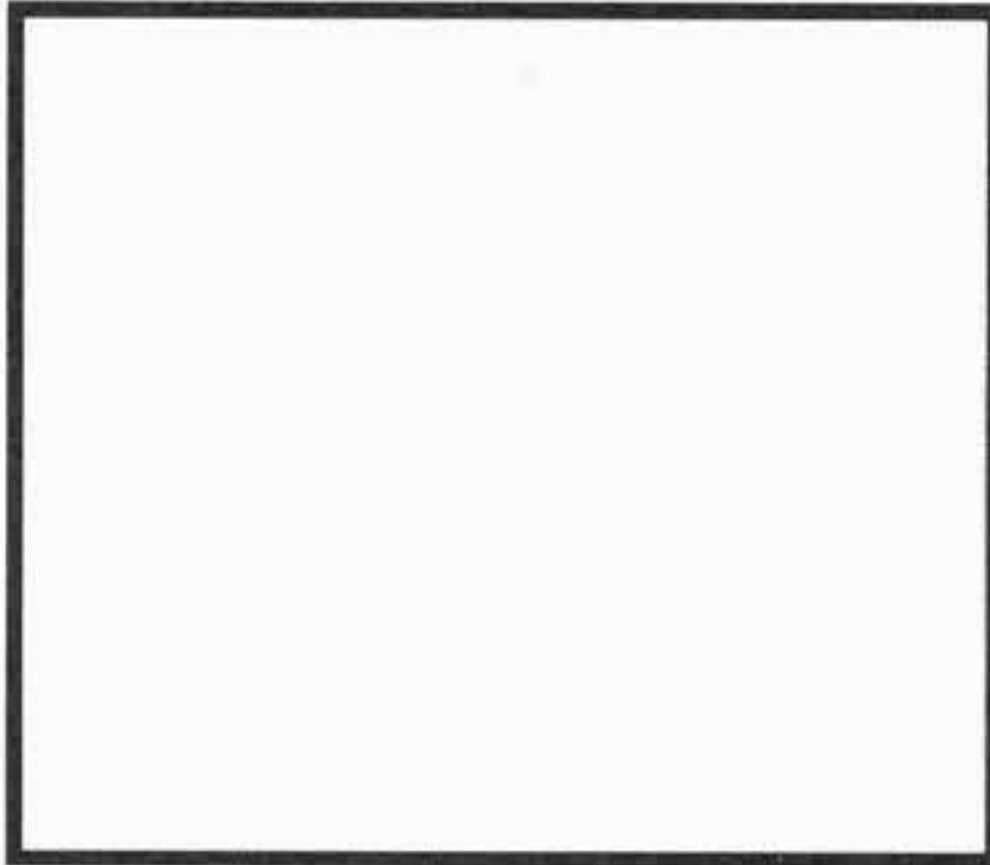
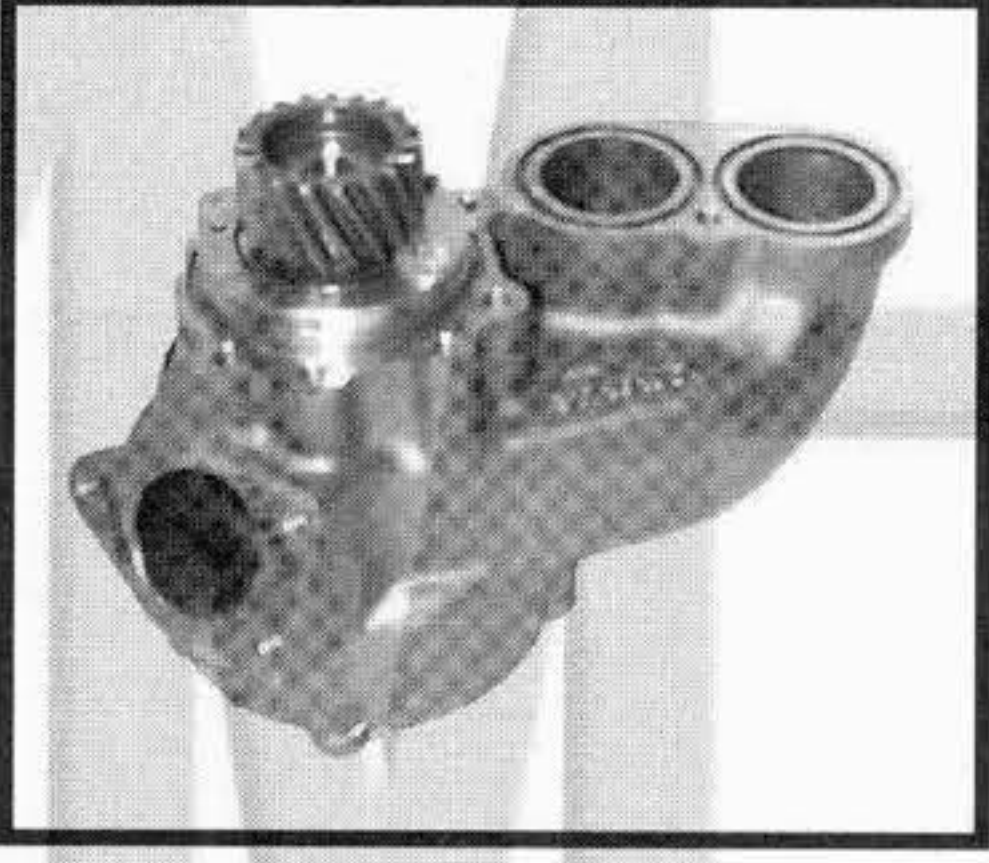
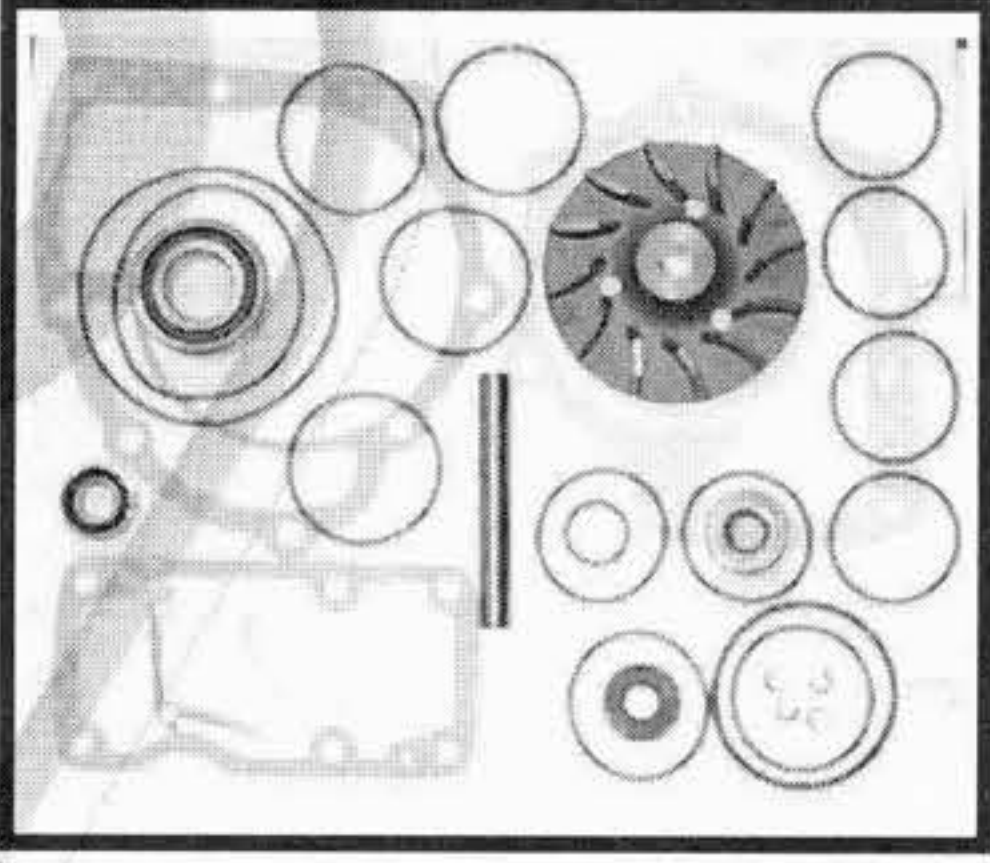
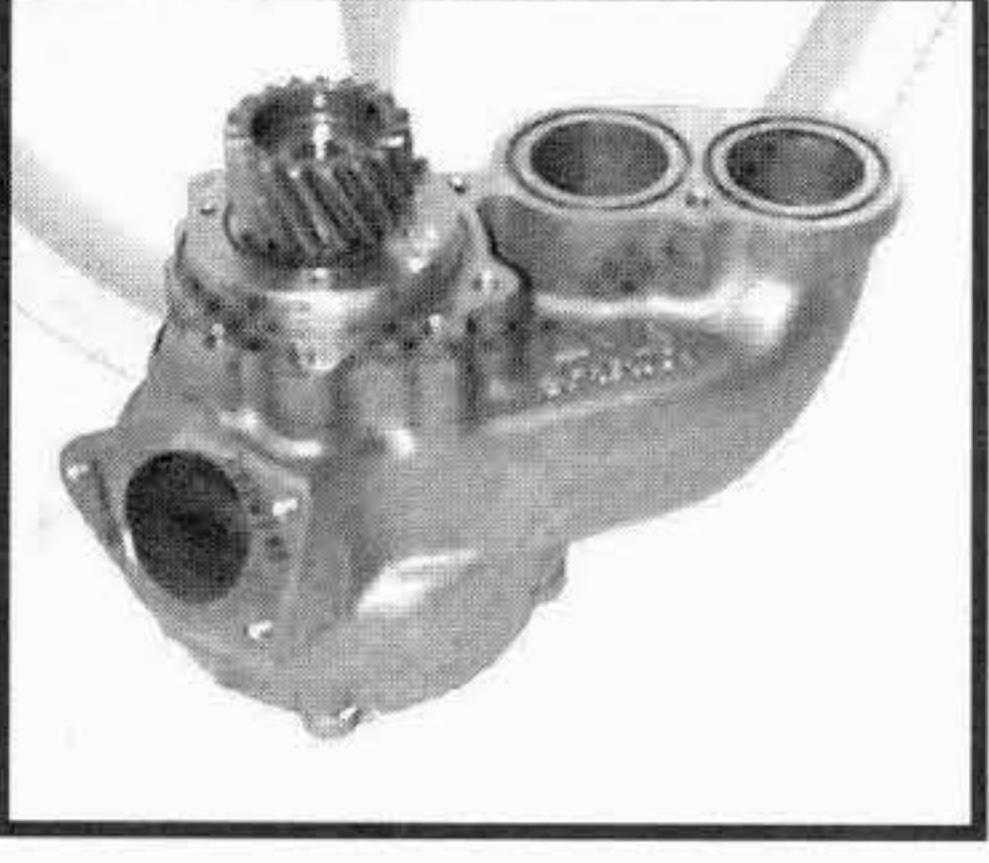

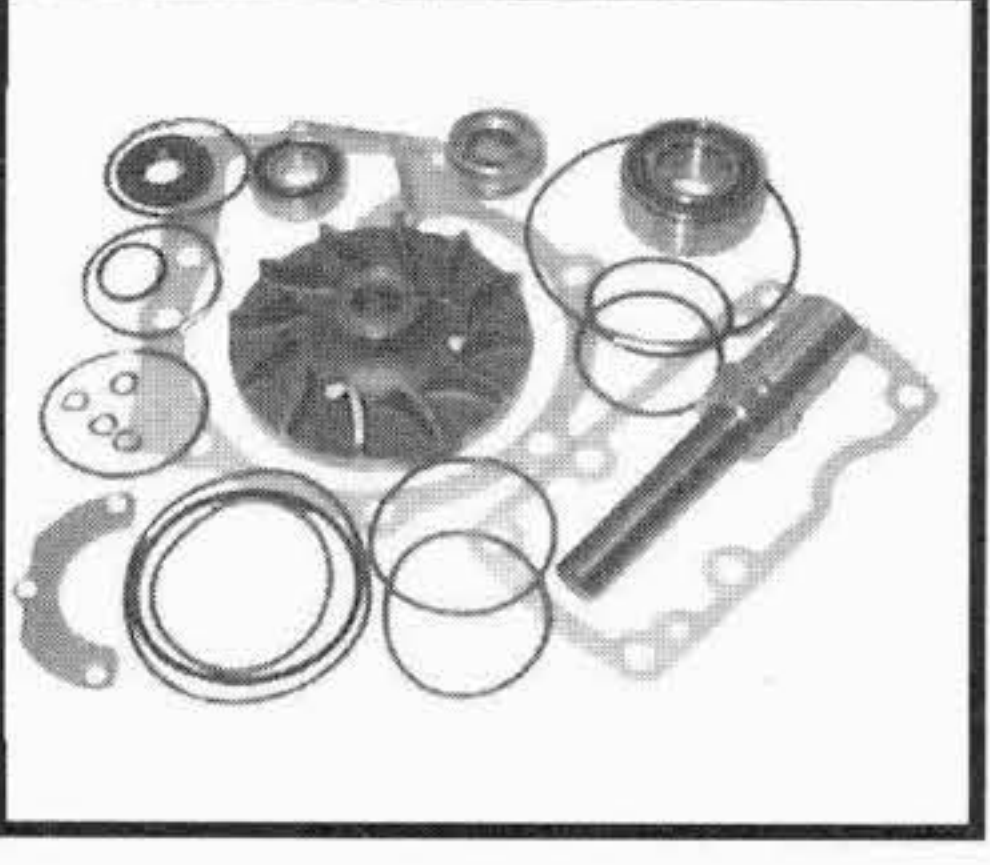
TIPO O MODELLO TYPE OU MODELE TYPE OR MODEL	MOTORE MOTEUR ENGINE	POMPA ACQUA POMPE A EAU WATER PUMP	KIT RIPARAZIONE NECESSAIRE DE REP. REPAIR KIT
		OMP REF. / O.EM. REF	OMP REF. / O.EM. REF
<p>B 10 B - SFL 12</p> <p>B 10 B Excellence 1000 / L / Shuttle</p> <p>B 10 B - SL 12</p> <p>B 10 M MK III</p> <p>B 10 R</p> <p>B 10 L</p> <p>C 10 M</p> <p>NEW !!</p>	<p>THD 102 KB</p> <p>THD 102 KD</p> <p>THD 102 KK</p> <p>THD 103 KB</p> <p>THD 103 KD</p> <p>THD 103 KF</p>	<p>317.290 425.268</p> 	<p>312.294 3097.084</p> 
<p>B 12</p> <p>Olympian Mk II</p>	<p>TD 120</p> <p>TD 121</p> <p>TD 122 FK</p> <p>TD 122 FS</p> <p>TD 122 FL</p> <p>TD 122 FH</p>	<p>317.160 1545.261</p> 	<p>312.276 276.802</p>  <p>in alternativa / alternatively use 312.171 275.615</p>
<p>B 12</p> <p>Olympian Mk II</p>	<p>TD 122 FK - OCS</p> <p>TD 122 FS - OCS</p> <p>TD 122 FL - OCS</p> <p>TD 122 FH - OCS</p>	<p>317.190 422.791</p> 	<p>312.175 270.791</p> 
<p>B 12 ---> fino al telaio N° 4999</p> <p>Olympian Mk II</p> <p>NEW !!</p>	<p>TD 123 E</p> <p>TD 123</p>	<p>317.240 1675.945</p> 	<p>312.278 276.814</p> 

I ricambi non sono originali ma adattabili . Ogni riferimento originale é assolutamente indicativo .
Spare parts are not original but perfectly suitable . Every original part number has to be considered for reference purpose only .

SUITABLE

VOLVO**AUTOCARRI - CAMIONS - TRUCKS - LKW****Tel:+44(0)1925 850082 Fax: +(0)44 1925 850083****www.spwaterpumps.co.uk****SP**
WATER PUMPS

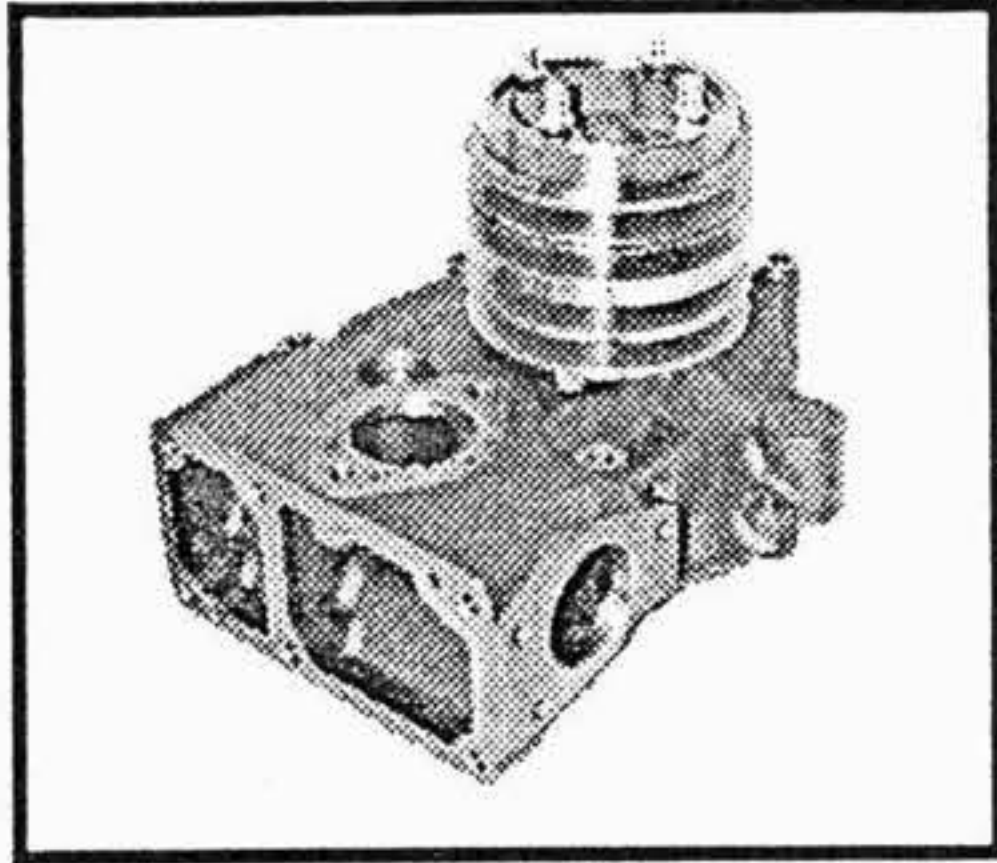
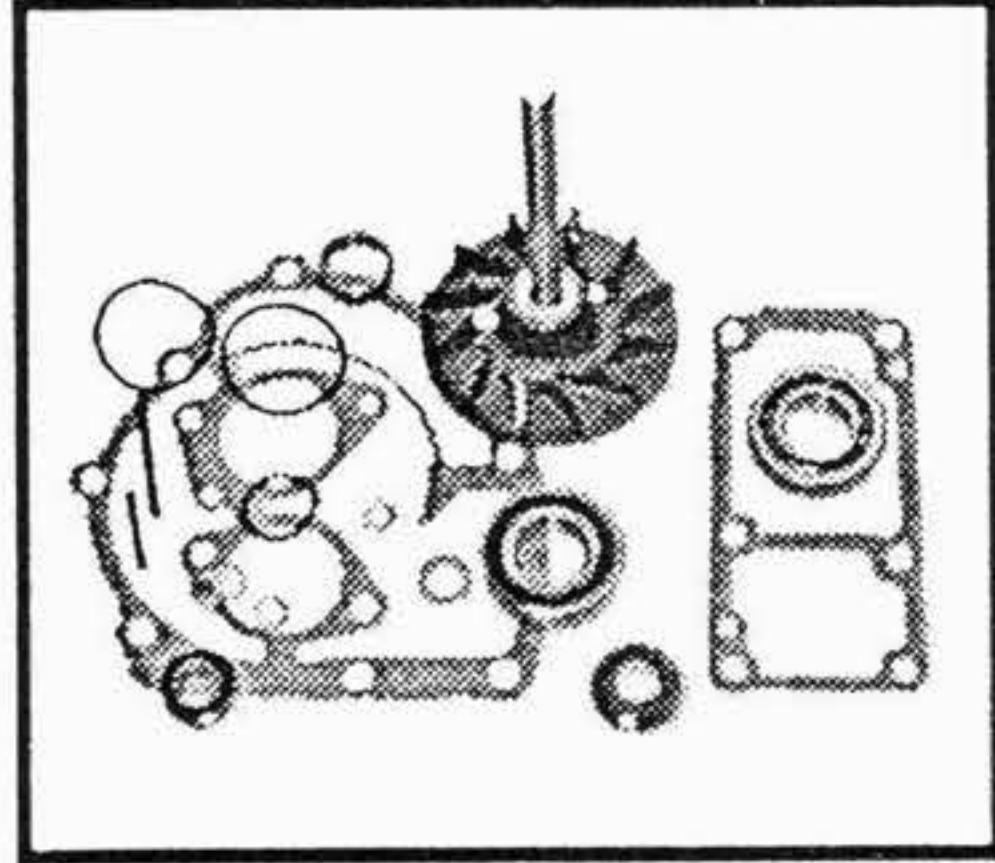
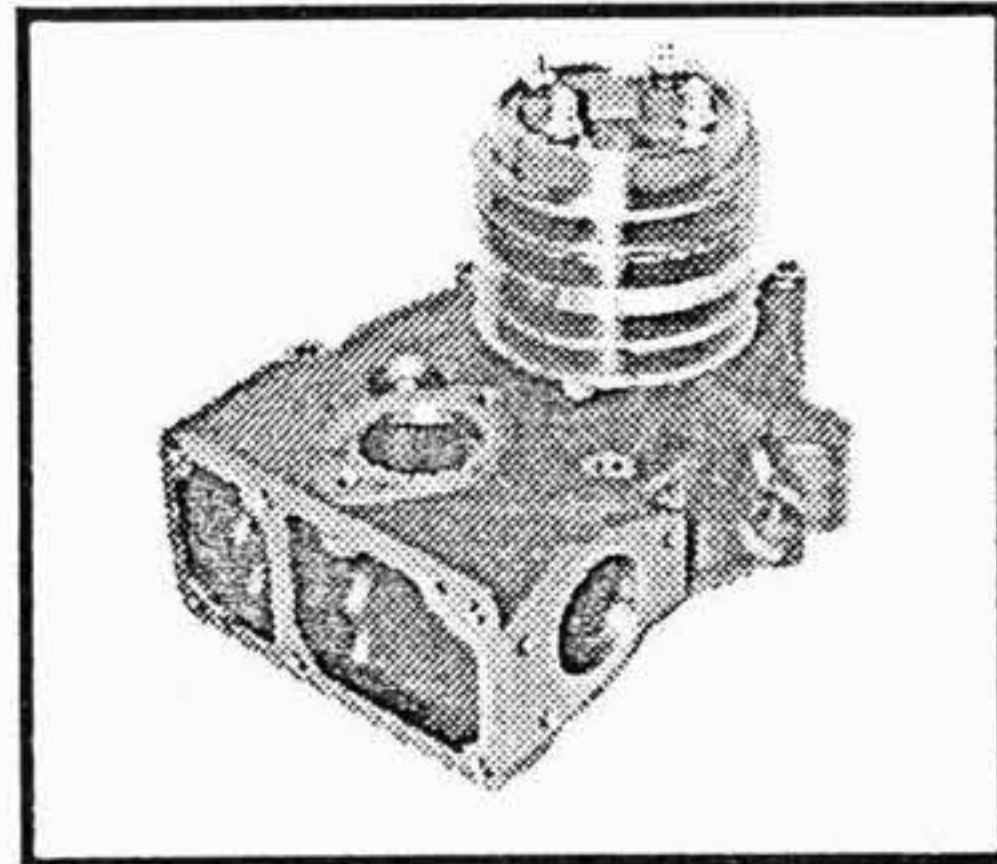
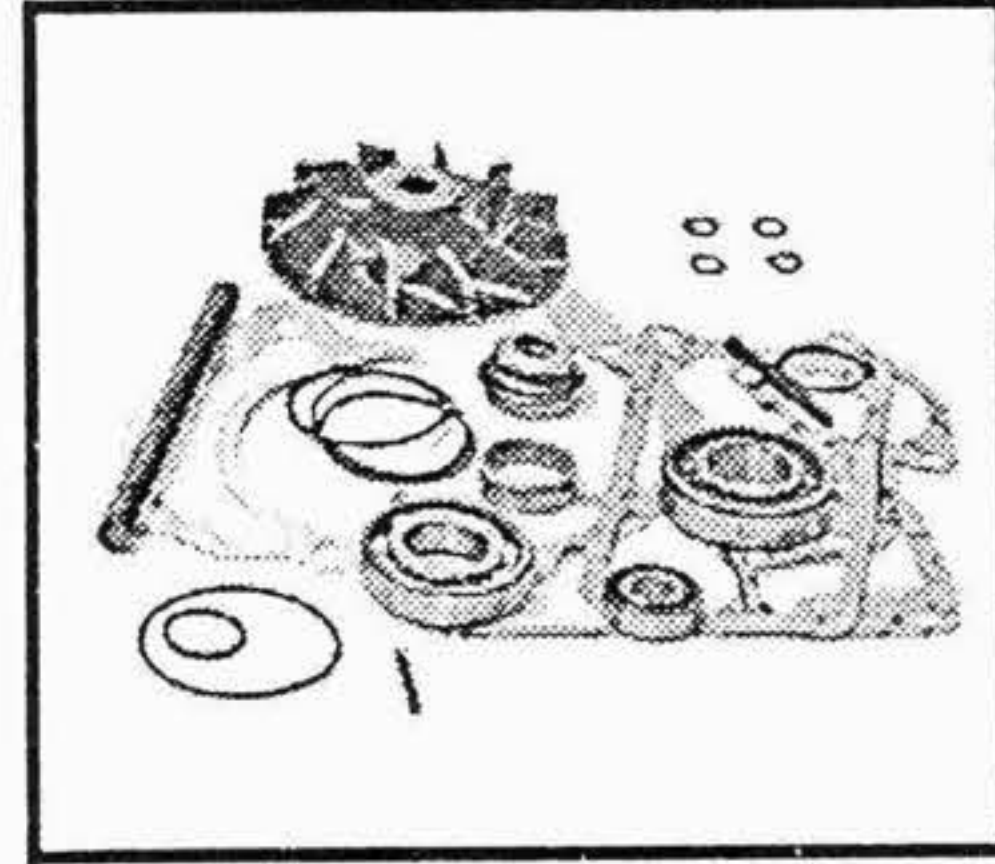
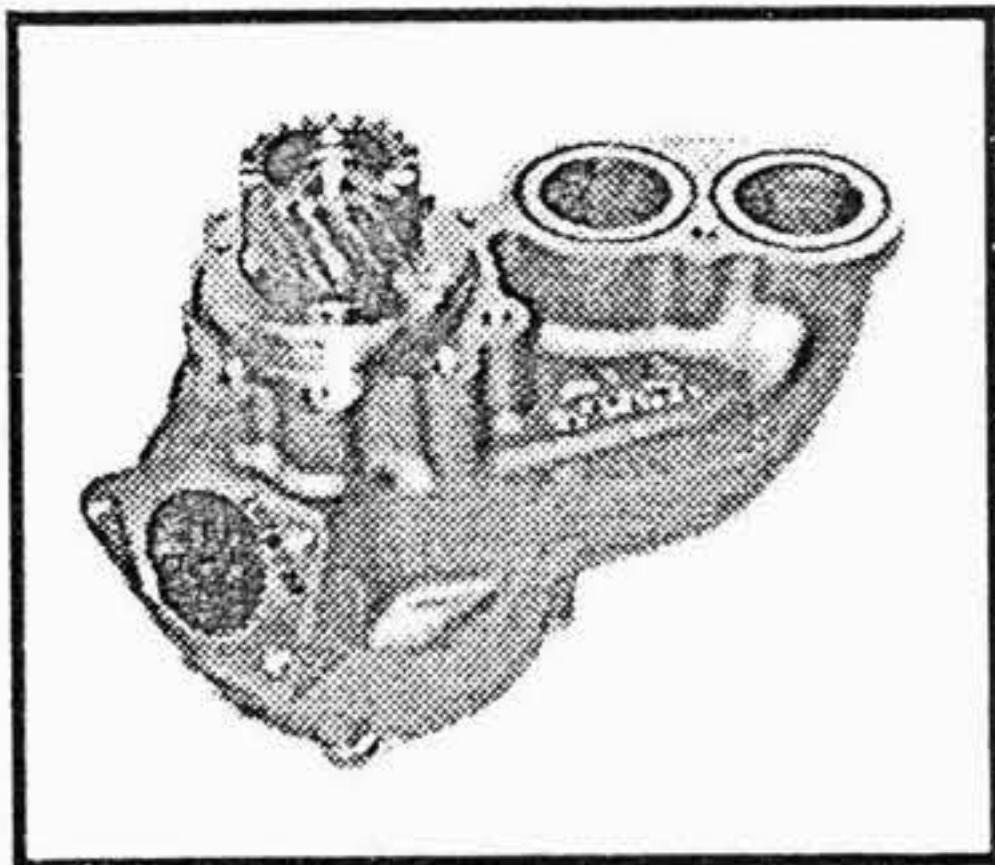
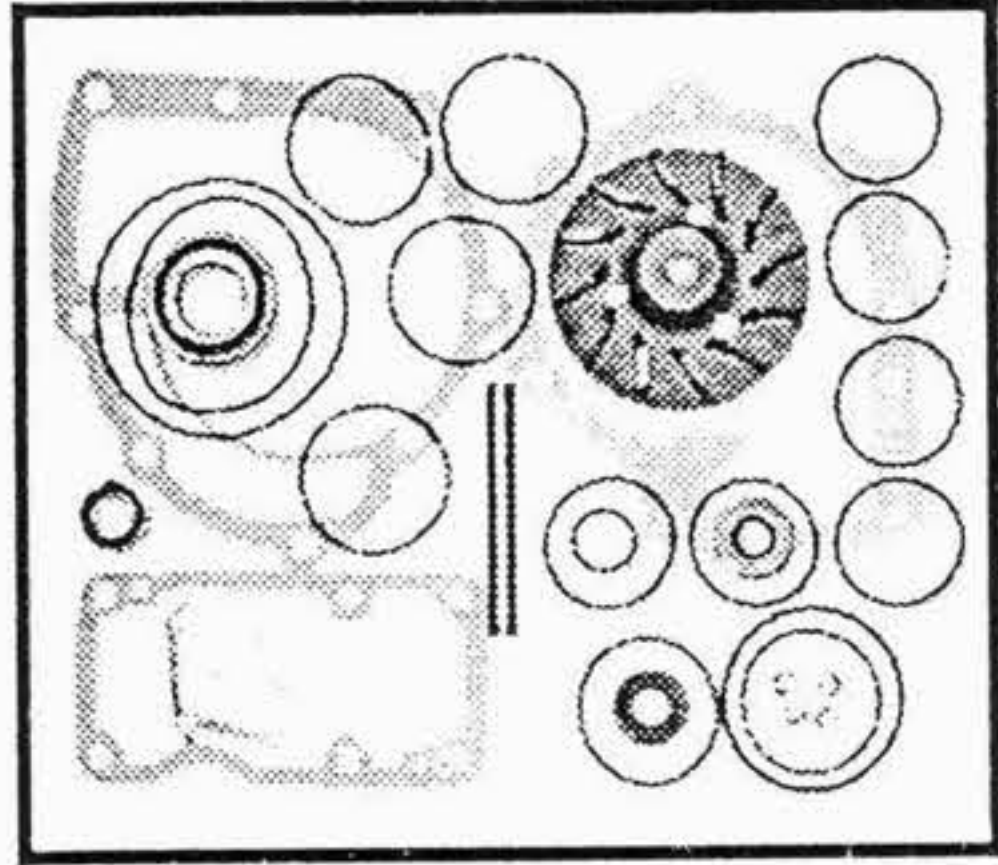
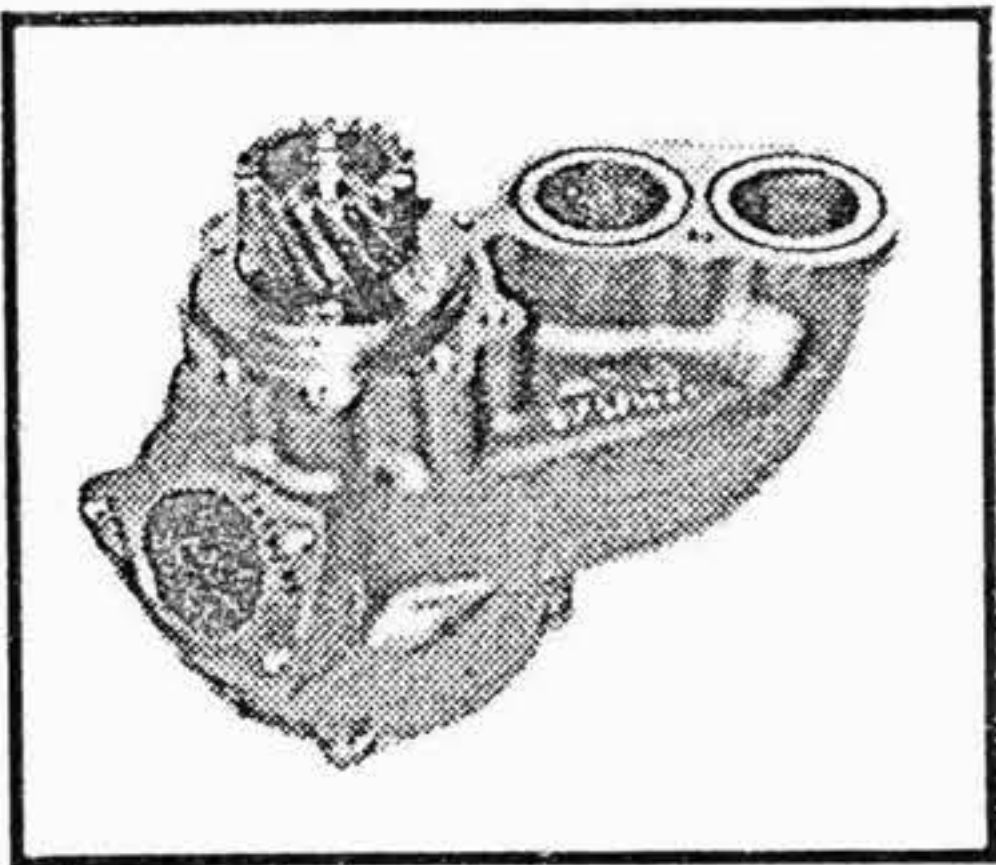
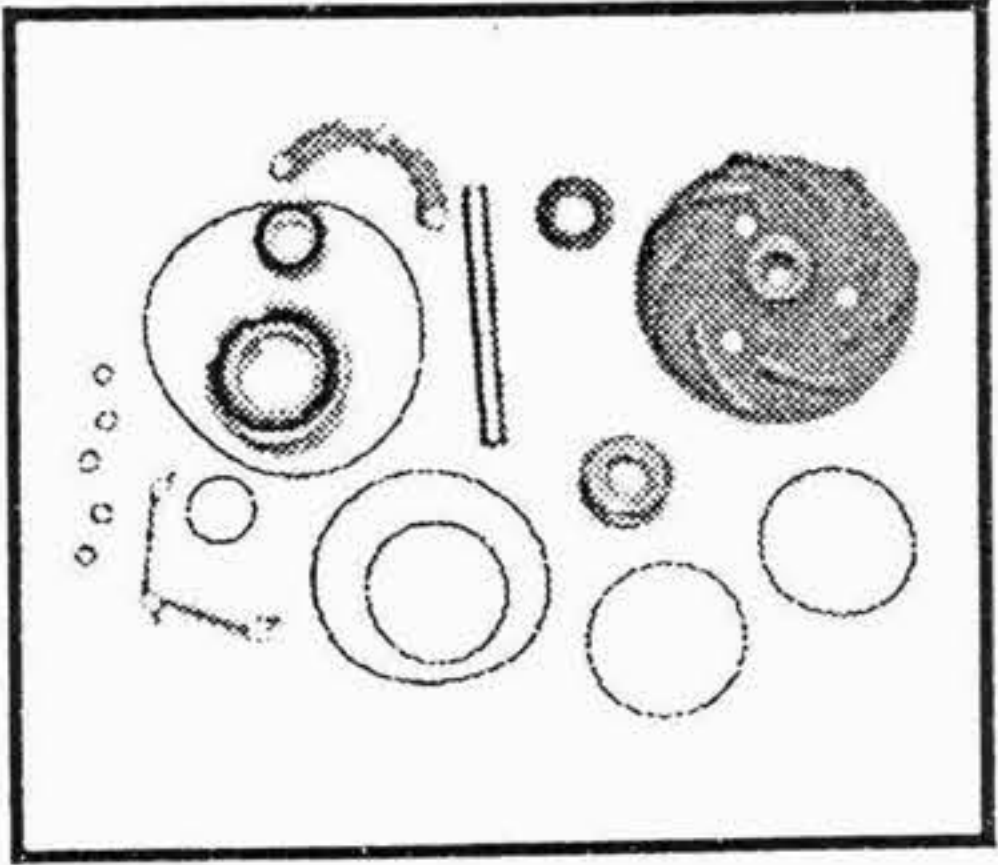
TIPO O MODELLO TYPE OU MODELE TYPE OR MODEL	MOTORE MOTEUR ENGINE	POMPA ACQUA POMPE A EAU WATER PUMP	OMP REF. / O.E.M. REF	KIT RIPARAZIONE NECESSAIRE DE REP. REPAIR KIT	OMP REF. / O.E.M. REF
N 10 dal telaio 304000 --->	TD 101 USA		317.195 1545.427		312.178 275.986
NL 10 S dal telaio 304000 --->	TD 101 USA				
N 10 MARK II dal telaio 304000 -->	TD 101 USA	ad esaurimento sost. da / will be supersided by 317.225 1699.789		in alternativa / alternatively use 312.285 276.800	
N 10 dal telaio 304000 --->	TD 101 USA		317.225 1699.789		312.285 276.800
NL 10 - NL 10 S dal telaio 304000 --->	TD 101 USA				
N 10 MARK II dal telaio 304000 -->	TD 101 USA			in alternativa / alternatively use 312.172 275.618	
F 10 dal telaio 25001 ---> FL 10 INTERCOOLER 320 FL 10 FS 10 F 12 ---> fino al telaio 34000 F 12 dal telaio 34001 ---> F 12 INTERCOOLER 360 dal telaio 314000 ---> F 12 INTERCOOLER 420 N 12 ---> fino al telaio 12000 N 12 dal telaio 12001 ---> NL 10 S NL 12 - NL 12 S	TD 101 F TD 102 F TD 101 F TD 102 F TD 120 C/D/E/F/G/GA TD 121 F/FD/G/GD TD 122 FK / FS TD 120 A/E/G/GA TD 121 F/G/GA TD 121 GA TD 122 FK / FS		317.160 1545.261		312.276 276.802
F 10 INTERCOOLER 320 F 12 INTERCOOLER 360 F 12 INTERCOOLER 420	TD 102 F - OCS TD 122 FK/FS-OCS TD 122 FK/FS-OCS		317.190 422.791		312.175 270.791

I ricambi non sono originali ma adattabili . Ogni riferimento originale é assolutamente indicativo .
Spare parts are not original but perfectly suitable . Every original part number has to be considered for reference purpose only .

SUITABLE

VOLVO

AUTOCARRI - CAMIONS - TRUCKS - LKW
Tel:+44(0)1925 850082 Fax: +(0)44 1925 850083
www.spwaterpumps.co.uk

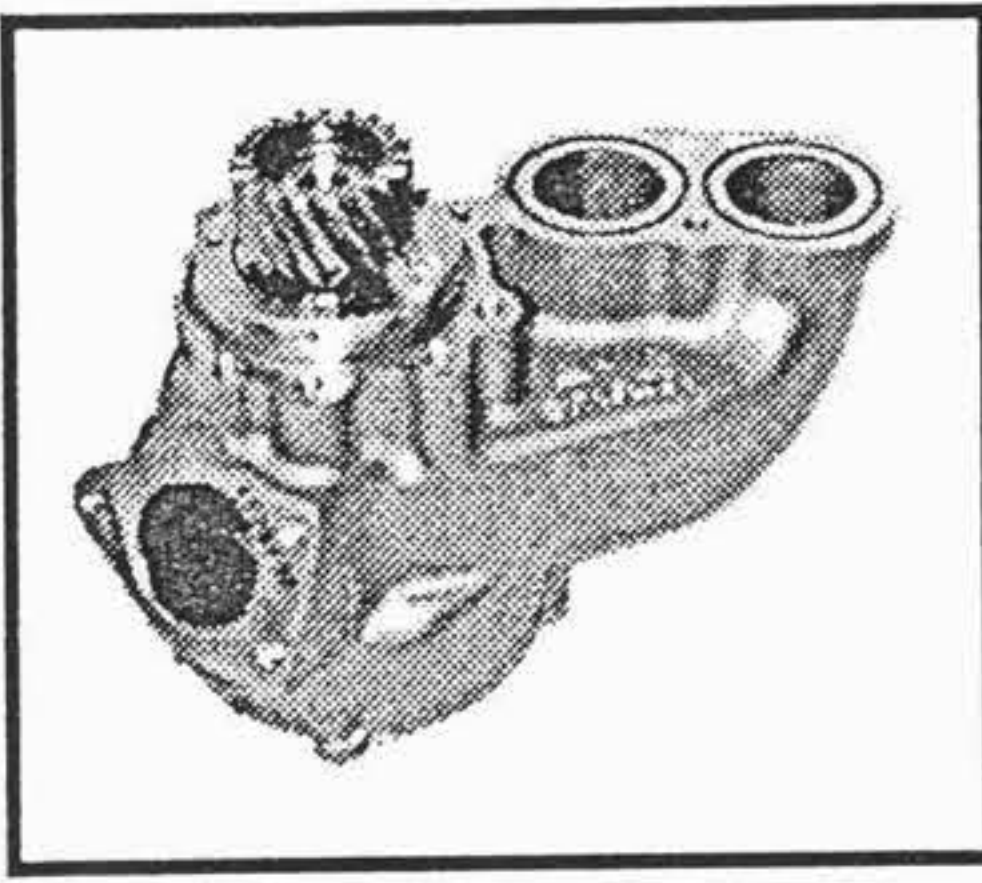
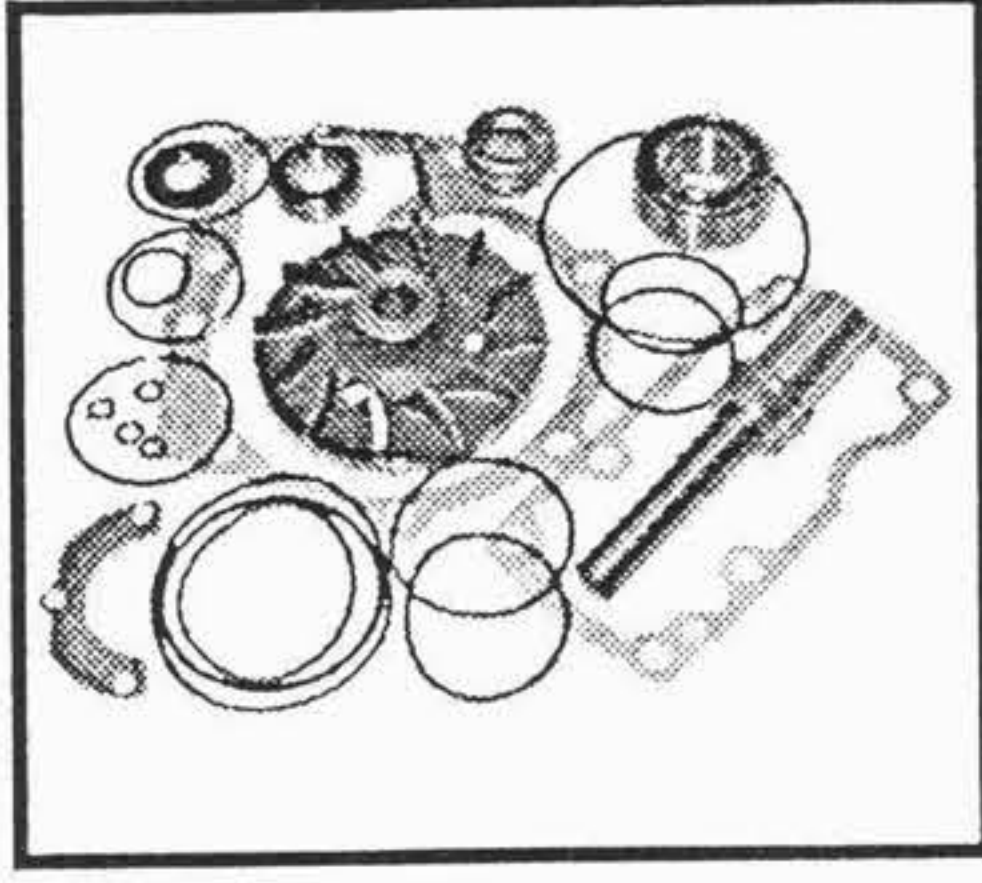
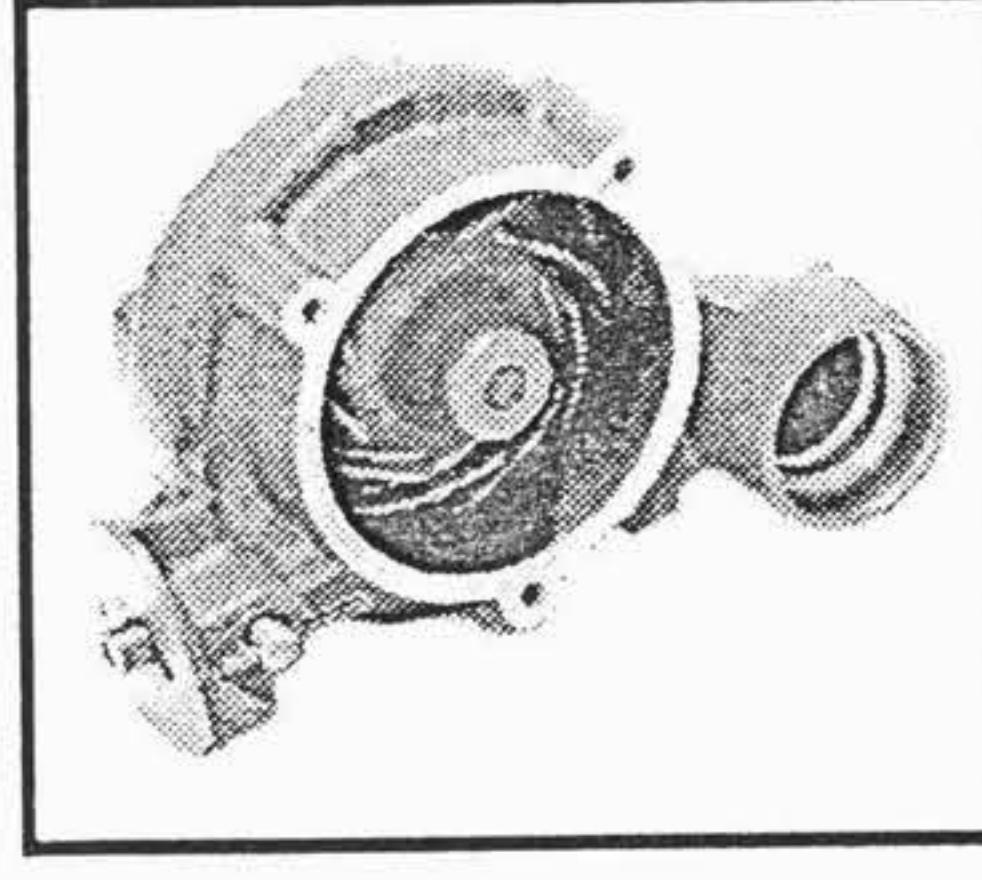
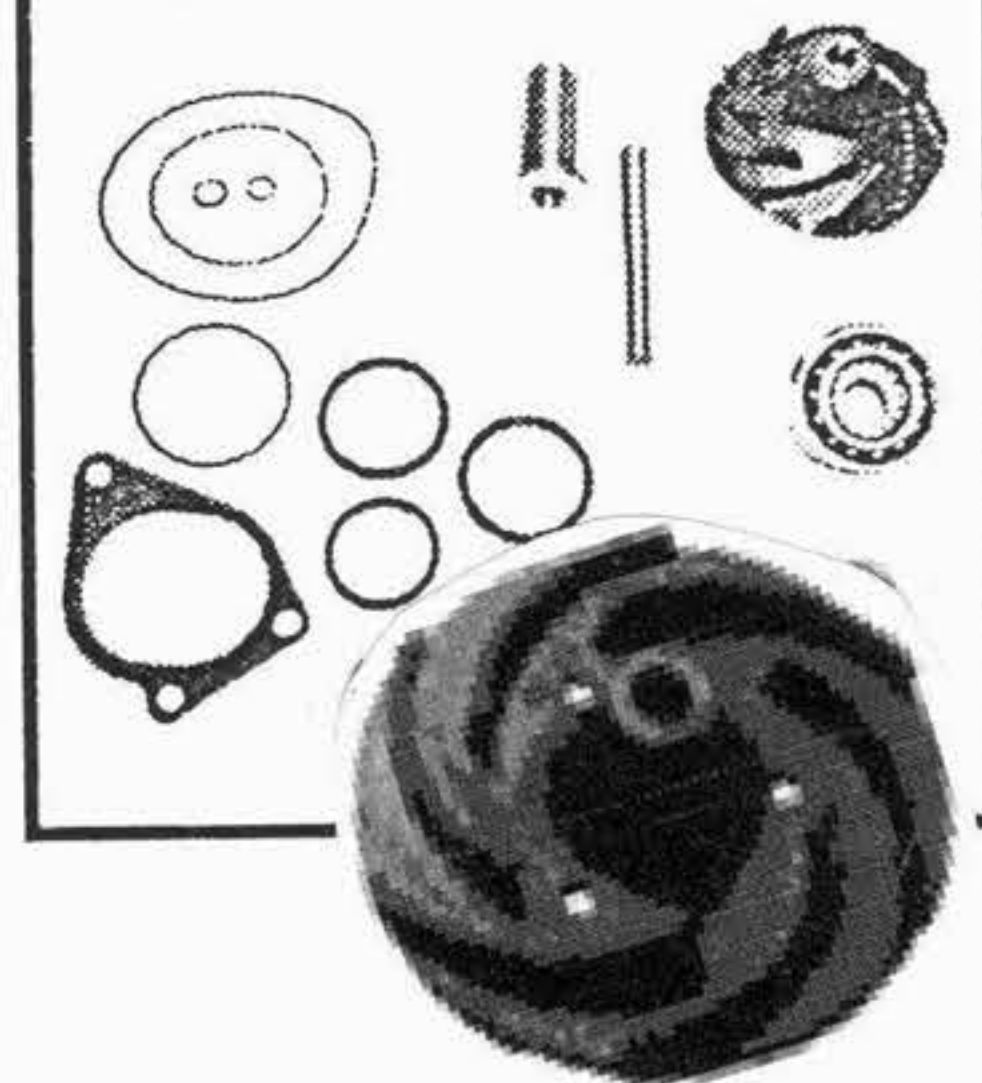
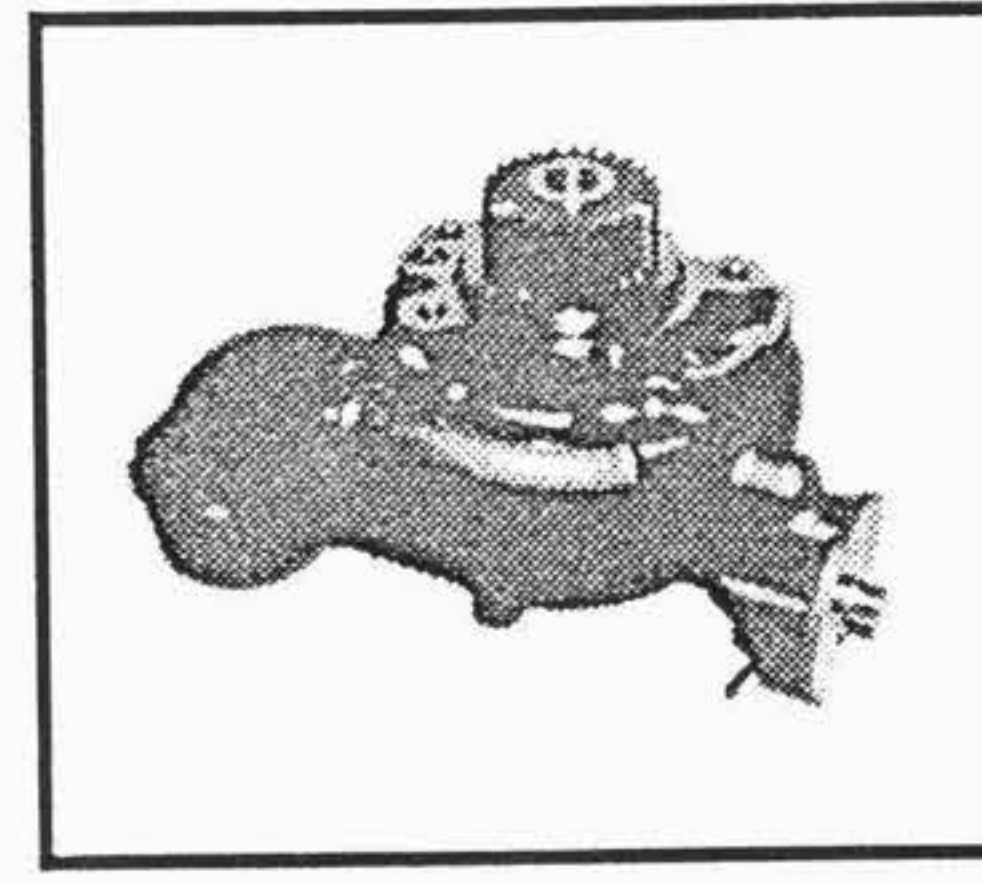
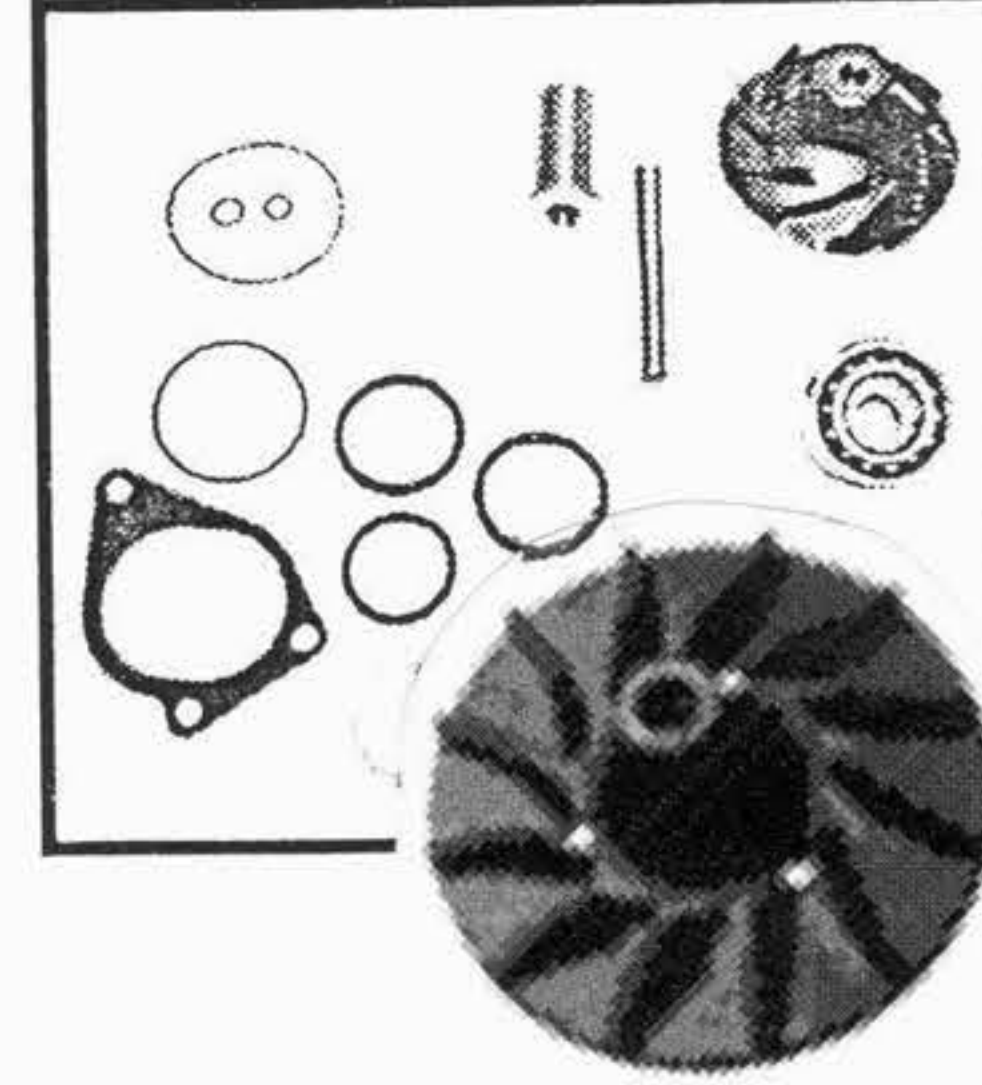
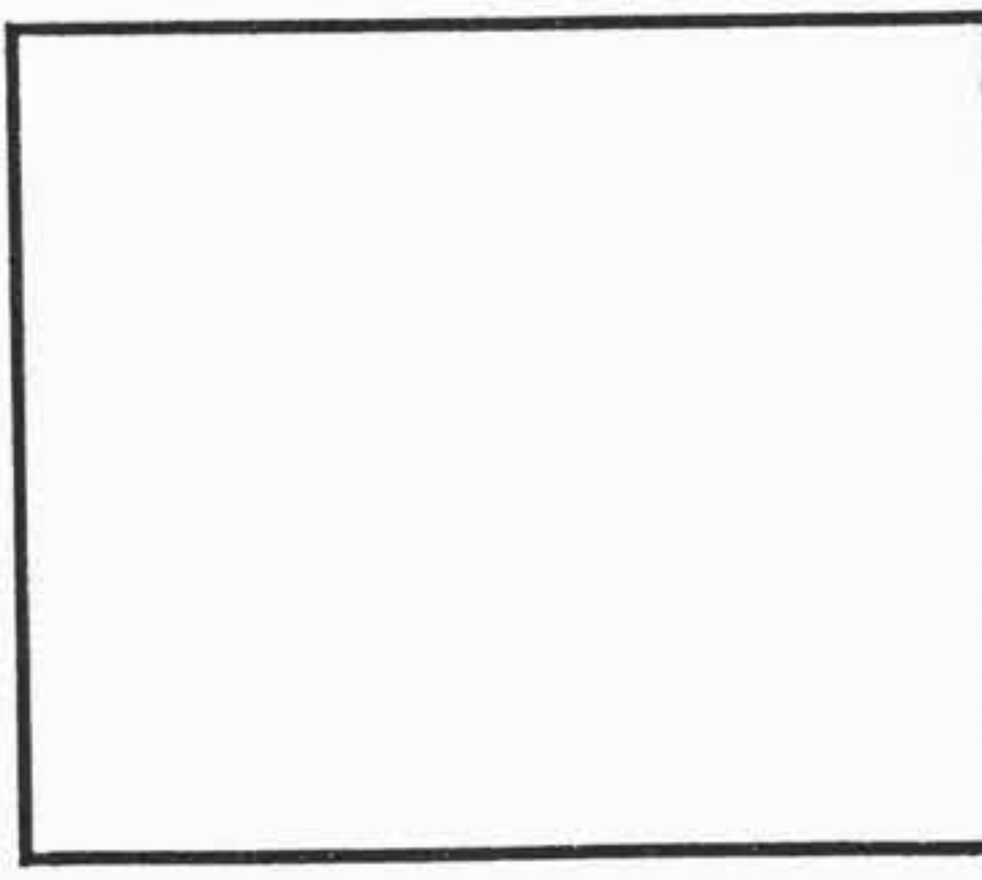
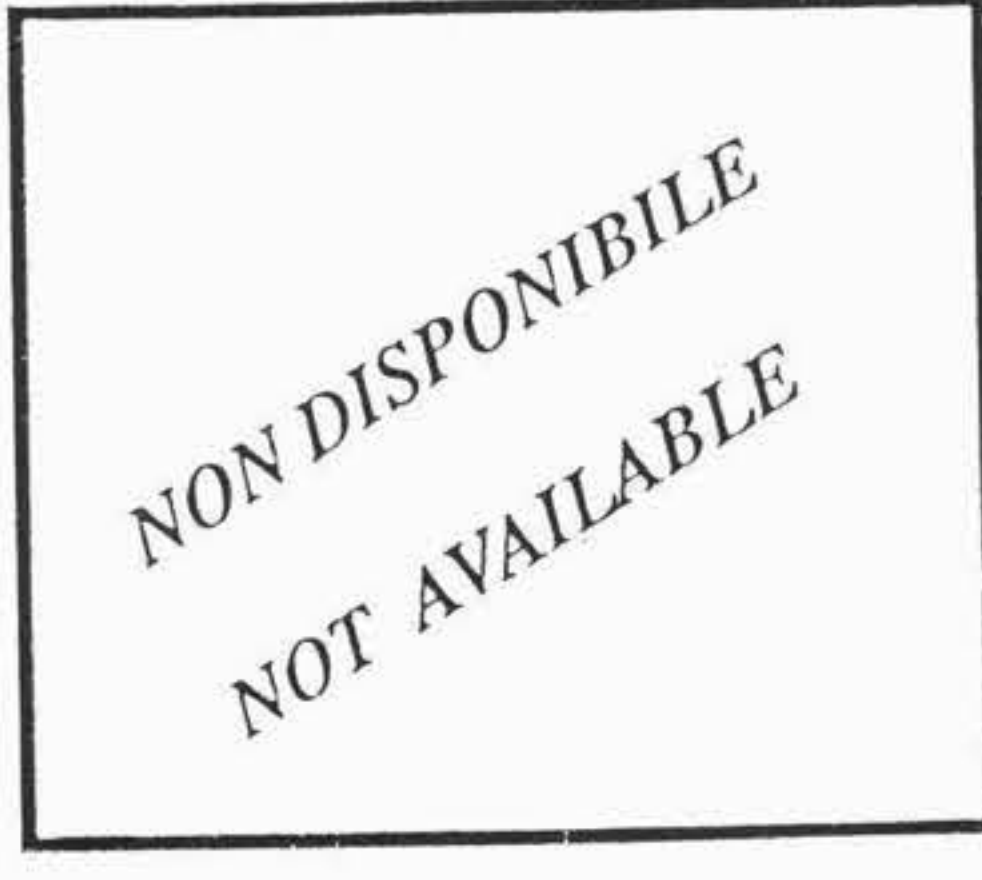

TIPO O MODELLO TYPE OU MODELE TYPE OR MODEL	MOTORE MOTEUR ENGINE	POMPA ACQUA POMPE A EAU WATER PUMP	KIT RIPARAZIONE NECESSAIRE DE REP. REPAIR KIT
F 10 dal telaio 314000 ---> FL 10 FS 10 F 12 FL 12 NL 10 NL 10 S NL 12 NL 12 S	TD 102 TD 103 E TD 103 ES TD 103 TD 123 E TD 123 E TD 123 ES	317.240 1675.945 	312.278 276.814 
FH 12 fino al telaio / up to chassis ---> 2911151 FL 10 FL 12 Per versioni con cambio manuale For vehicles with manual gearbox * Pour vehicules avec boîte de vitesse manuelle	D 12 A D 12 A D 12 A	317.250 8149.941 	312.291 276.121 
FH 12 fino al telaio / up to chassis ---> 2911151 FL 12 Per versioni con cambio automatico Per versioni con ritardatore VOITH For vehicles with automatic gearbox * For vehicles with VOITH hydraulic retarder	D 12 A 420 D 12 A 420 NEW !!	317.310 8149.882 	312.296 276.852 
FH 12 dal telaio / from chassis 2911152 ---> FM 12 Per versioni con cambio manuale For vehicles with manual gearbox	D 12 C D 12 C NEW !!	317.320 8170.305 	--- ---  <p>NON DISPONIBILE NOT AVAILABLE</p>

I ricambi non sono originali ma adattabili . Ogni riferimento originale é assolutamente indicativo .
 Spare parts are not original but perfectly suitable . Every original part number has to be considered for reference purpose only .

SUITABLE



VOLVO

AUTOCARRI - CAMIONS - TRUCKS - LKW

Tel:+44(0)1925 850082 Fax: +(0)44 1925 850083

www.spwaterpumps.co.uk

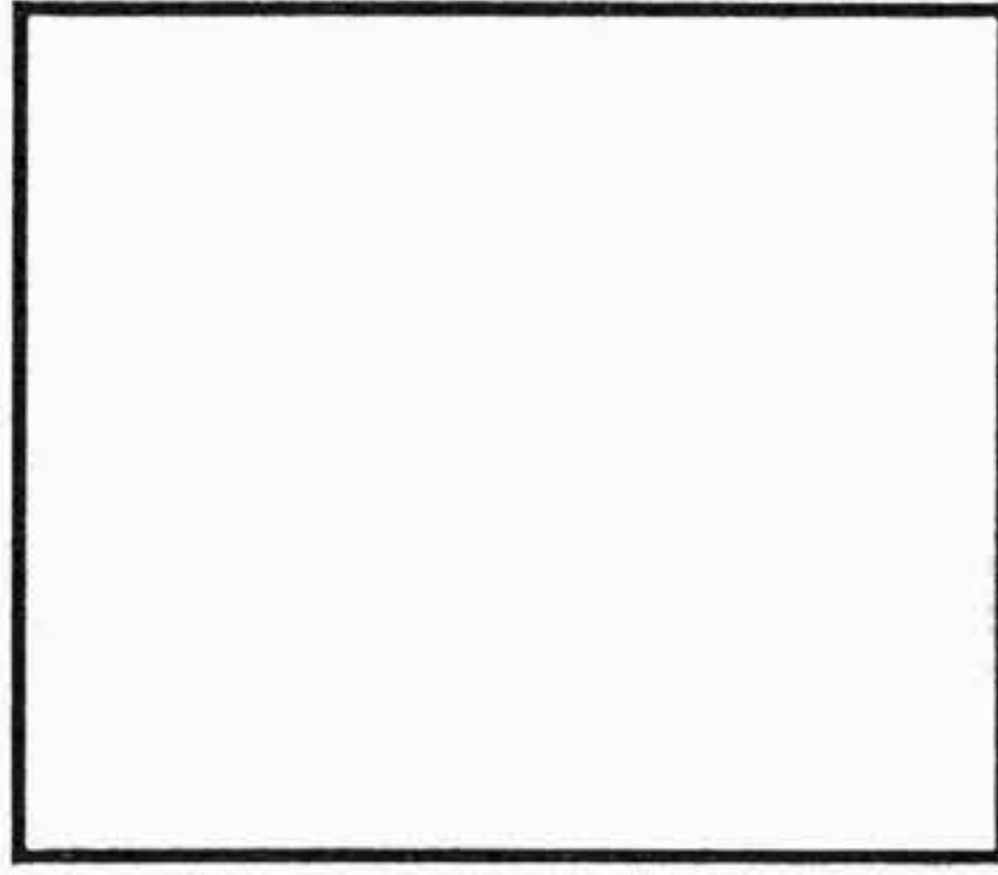
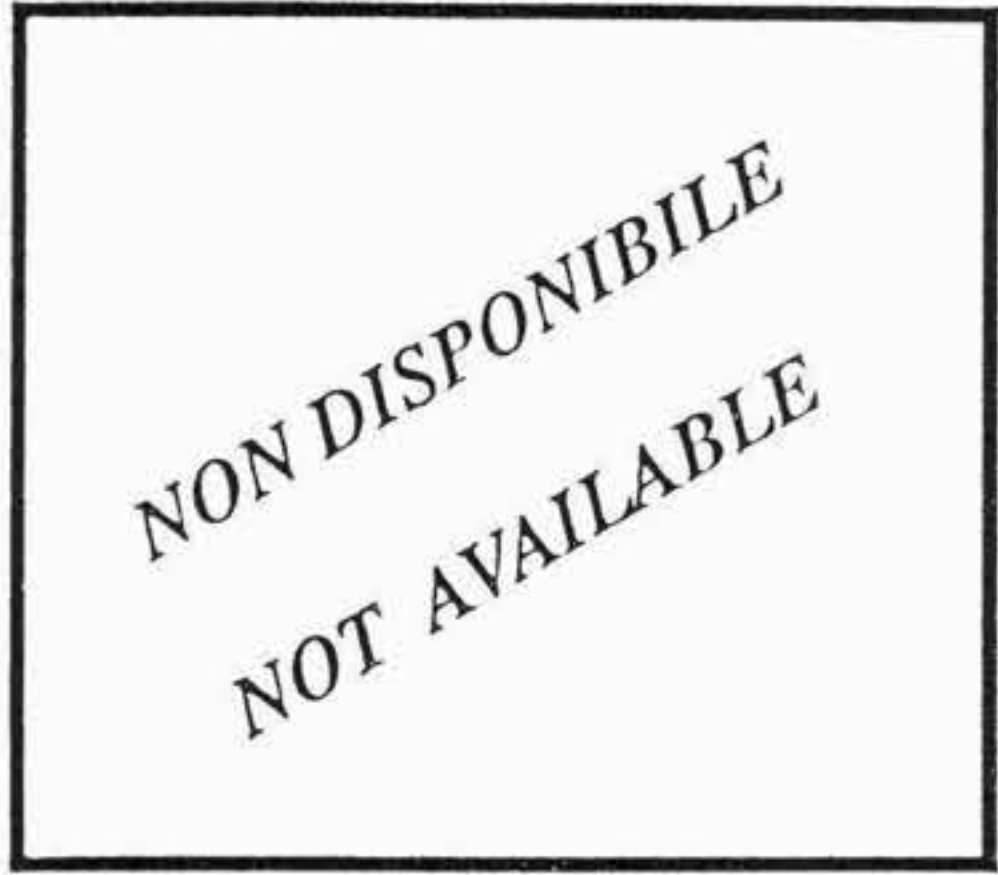
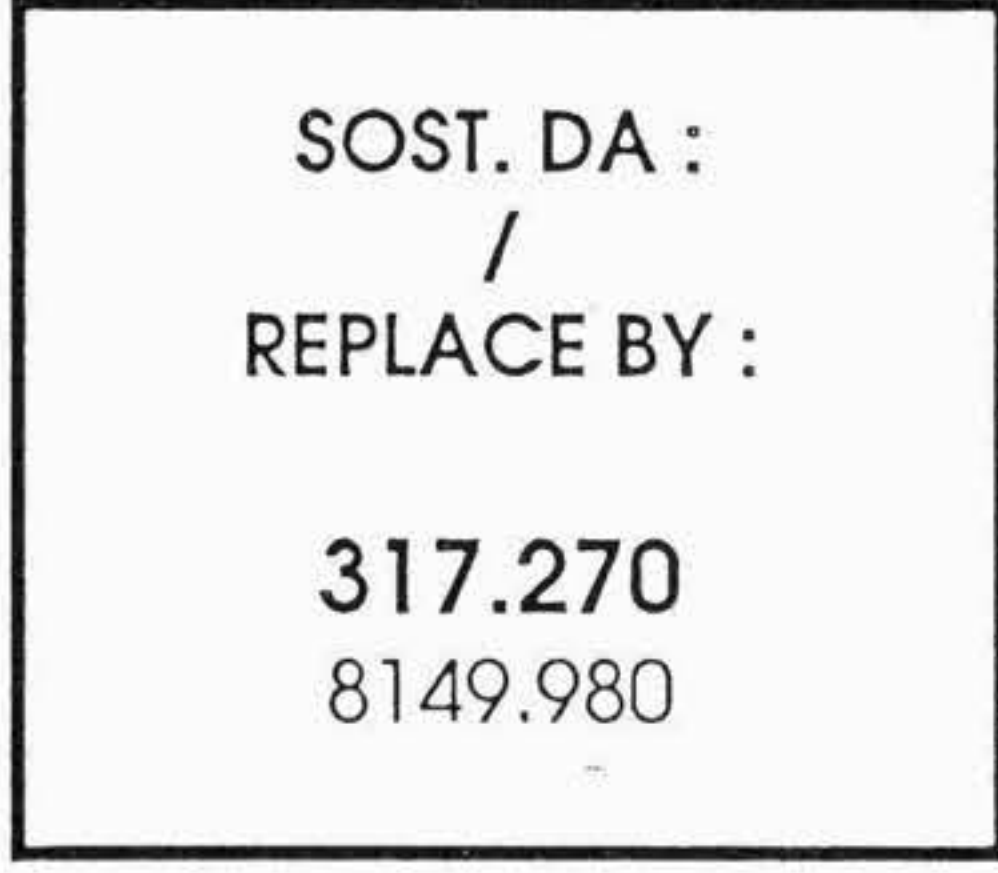

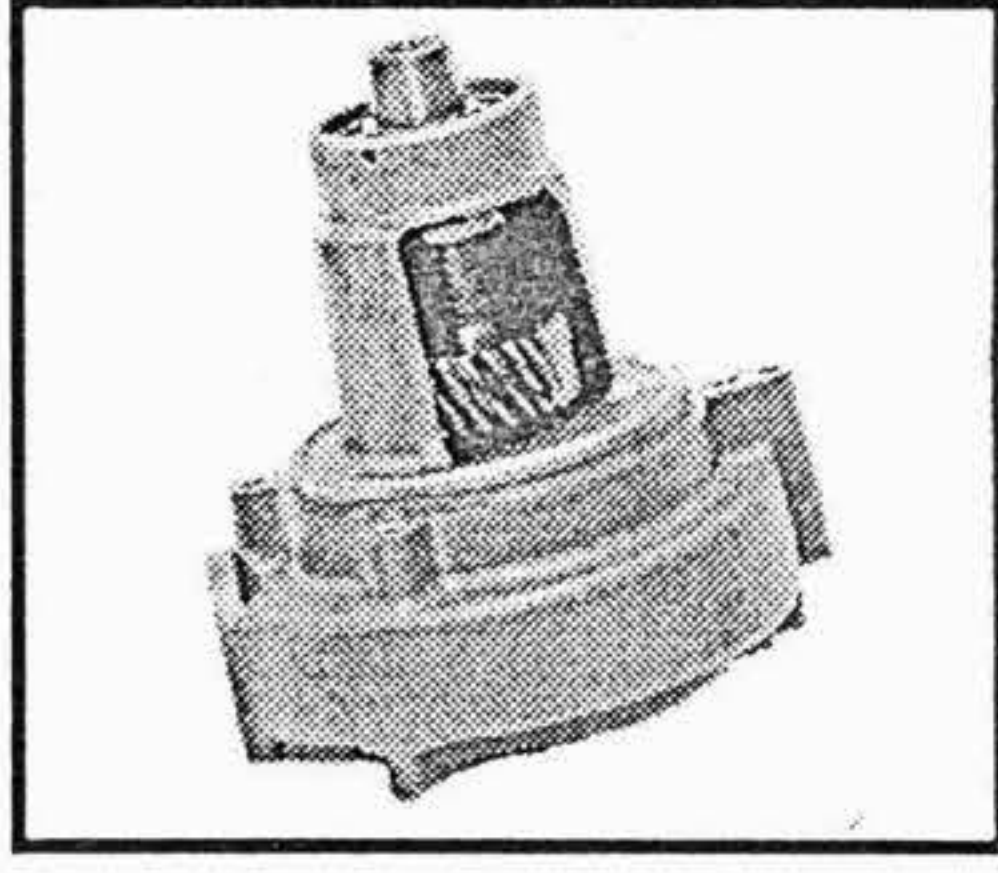
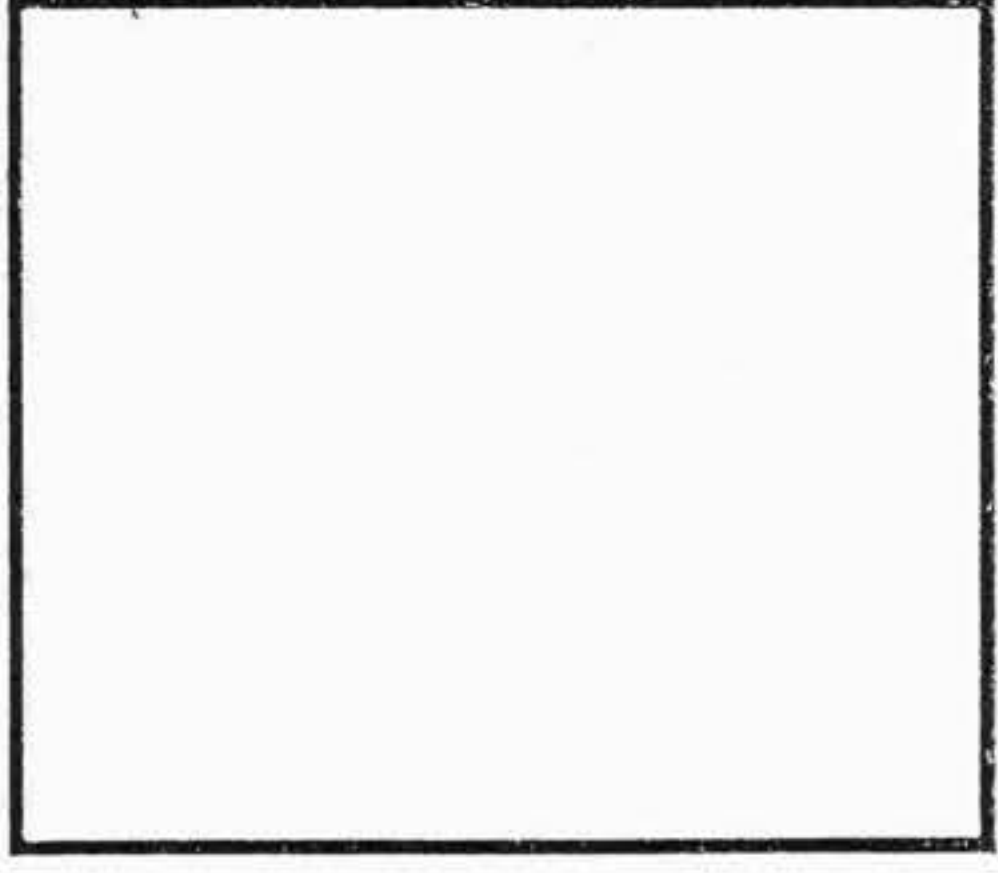
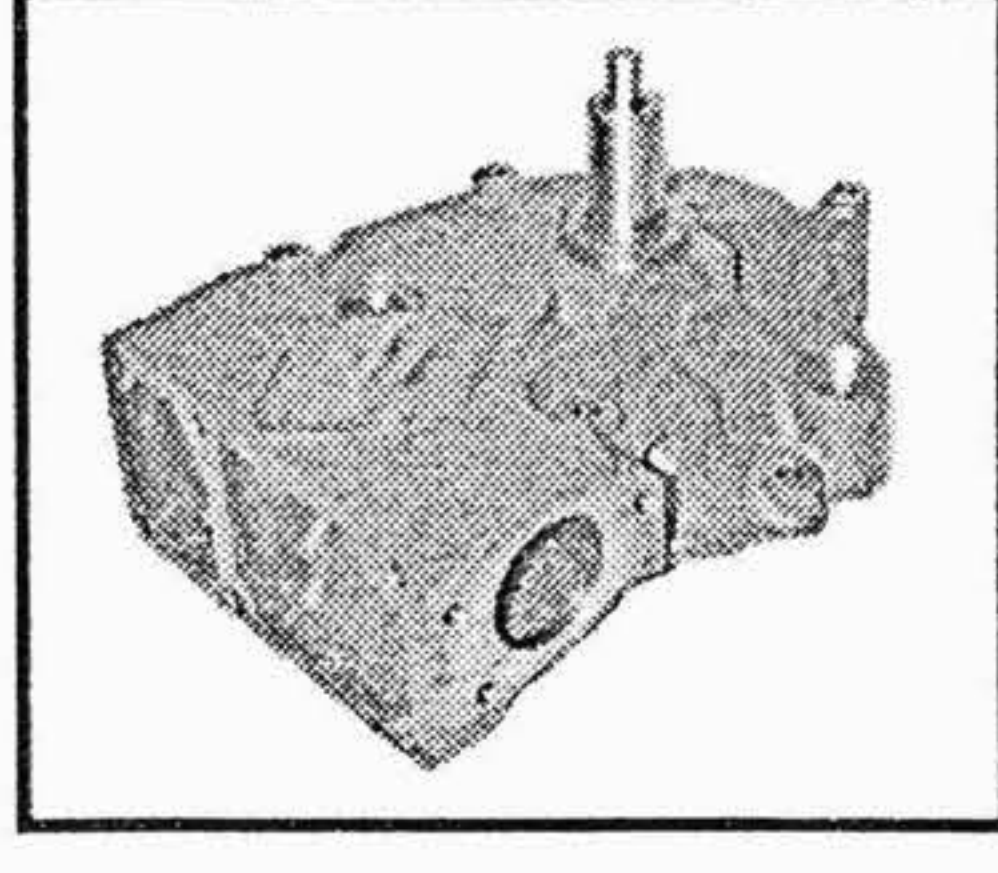
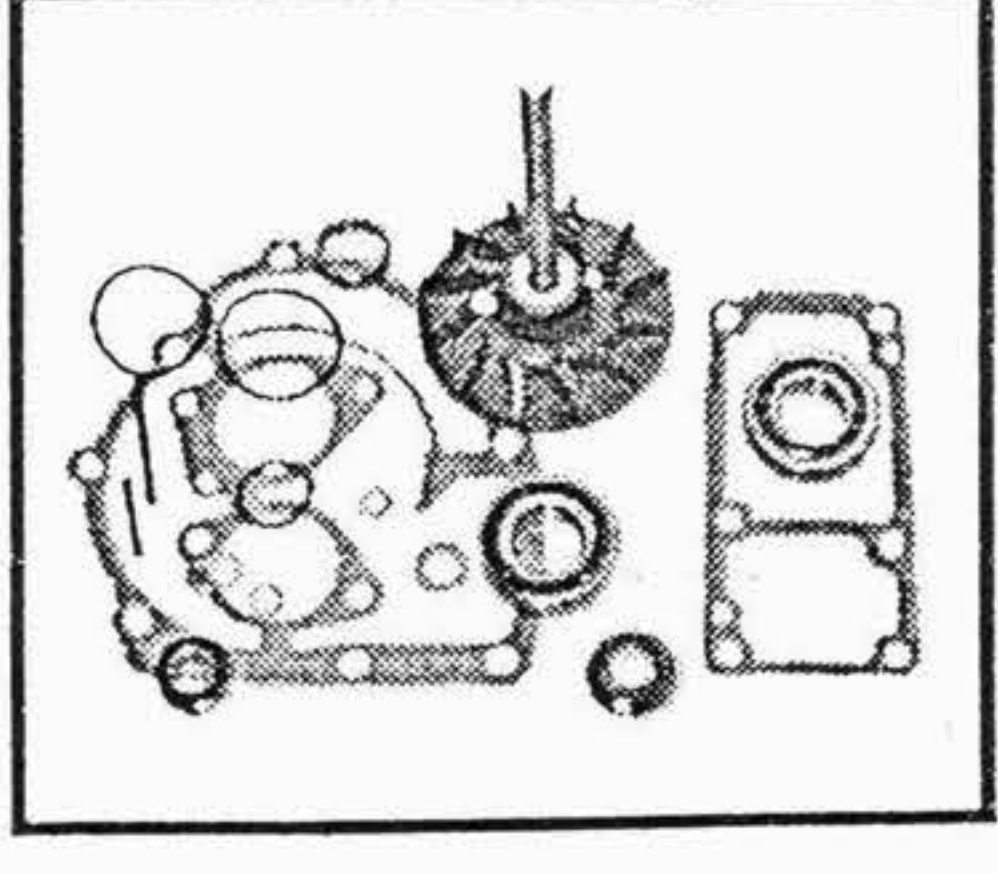
TIPO O MODELLO TYPE OU MODELE TYPE OR MODEL	MOTORE MOTEUR ENGINE	POMPA ACQUA POMPE A EAU WATER PUMP	KIT RIPARAZIONE NECESSAIRE DE REP. REPAIR KIT
<p>FH 12</p> <p>dal telaio / from chassis 2911152 ---></p> <p>FM 12</p> <p>Per versioni con cambio automatico</p> <p>Per versioni con ritardatore VOITH</p> <p>For vehicles with automatic gearbox</p> <p>For vehicles with VOITH hydraulic retarder</p>	<p>D 12 C</p> <p>D 12 C</p> <p>NEW !!</p>	<p>317.330 8170.833</p> 	<p>---</p> <p>---</p>  <p>NON DISPONIBILE NOT AVAILABLE</p>
<p>F 16</p>	<p>TD 162 F - FL</p> <p>TD 163 F - FL</p> <p>TD 164</p> <p>L330C Loading Shovel</p> <p>NEW !!</p>	<p>317.260 1556.330</p>  <p>SOST. DA : / REPLACE BY :</p> <p>317.270 8149.980</p>	<p>312.292 276.636</p> 
<p>FH 16</p>	<p>D 16 A</p> <p>NEW !!</p>	<p>317.270 8149.980</p> 	<p>312.293 276.637</p> 
<p>F 88</p> <p>N 88</p>	<p>D 100 B</p> <p>TD 100 A</p> <p>TD 100 B</p>	<p>317.050 422.311</p> 	<p>312.172 275.618</p> 

I ricambi non sono originali ma adattabili . Ogni riferimento originale é assolutamente indicativo .
Spare parts are not original but perfectly suitable . Every original part number has to be considered for reference purpose only .

SUITABLE

VOLVO

AUTOCARRI - CAMIONS - TRUCKS - LKW
Tel:+44(0)1925 850082 Fax: +(0)44 1925 850083
www.spwaterpumps.co.uk

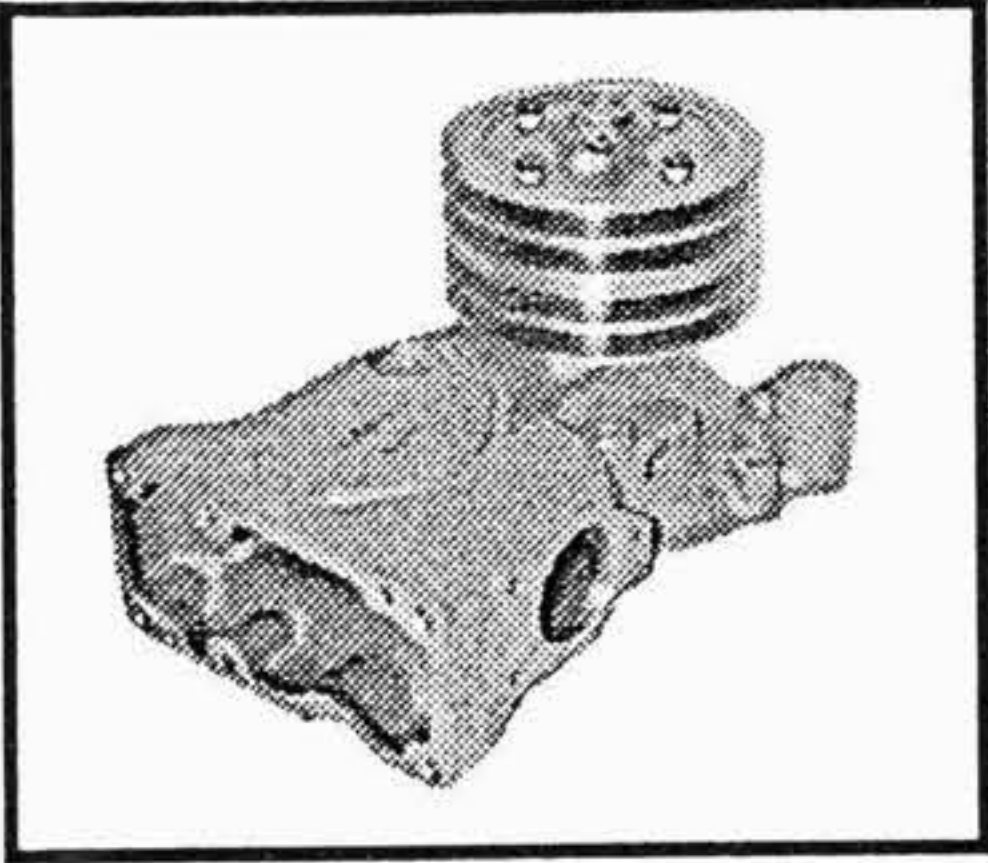
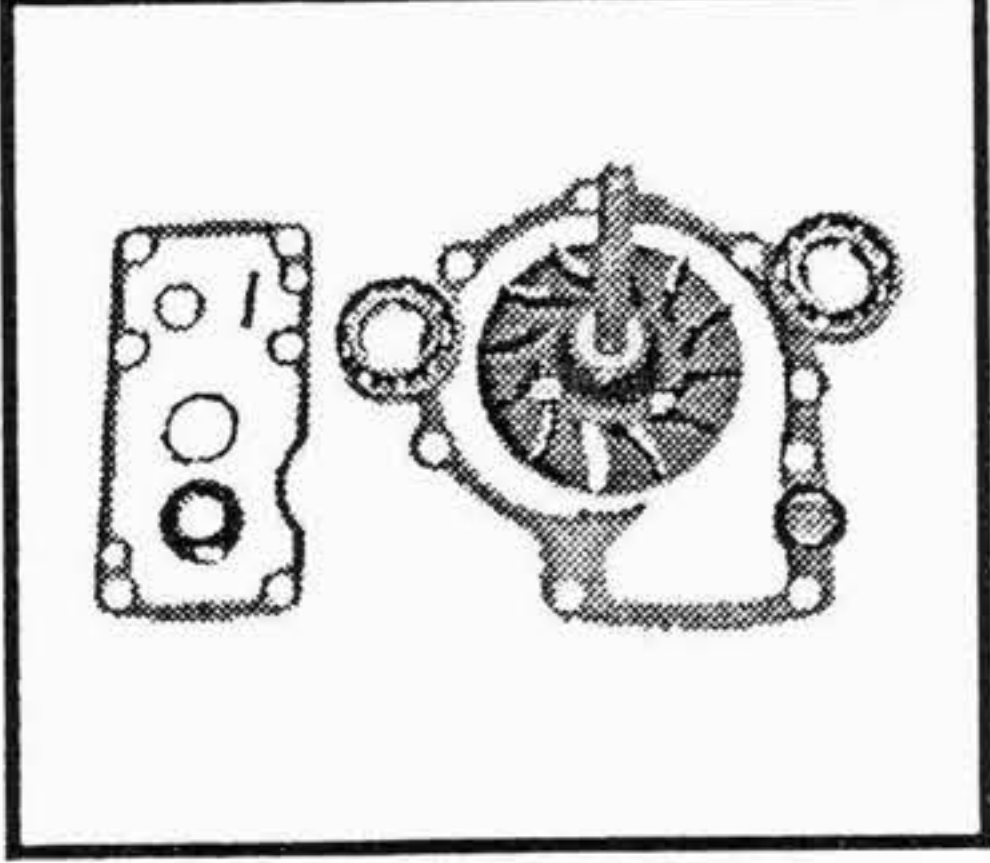
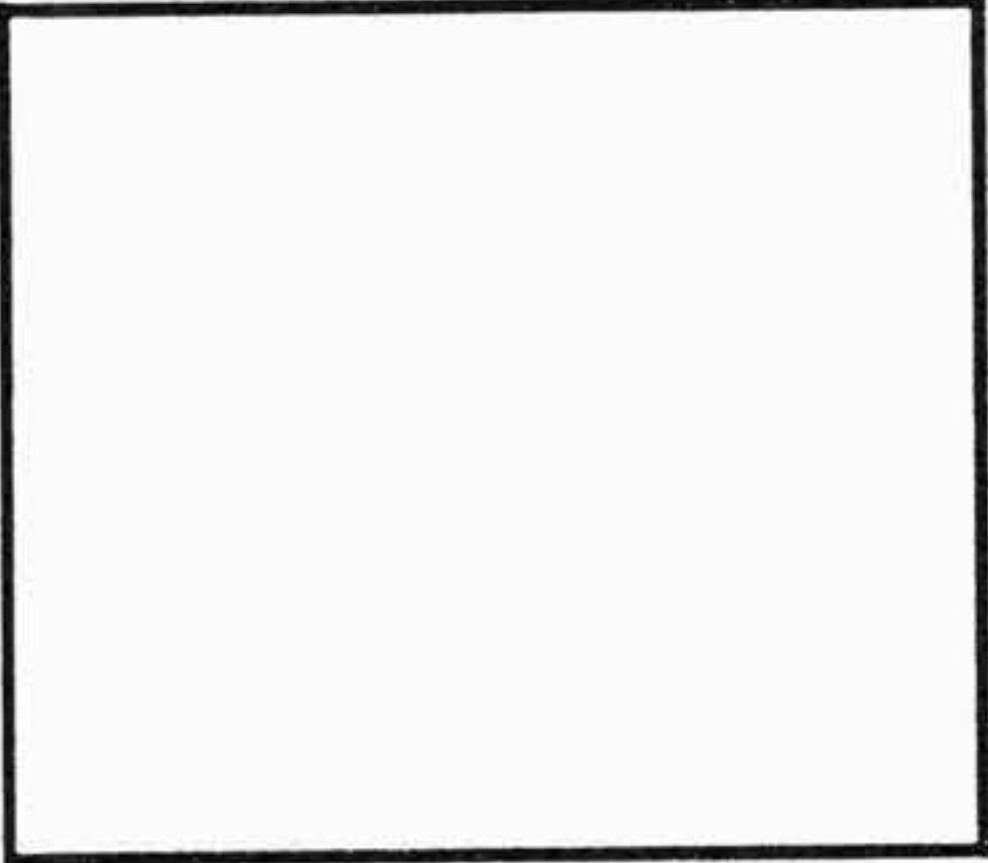
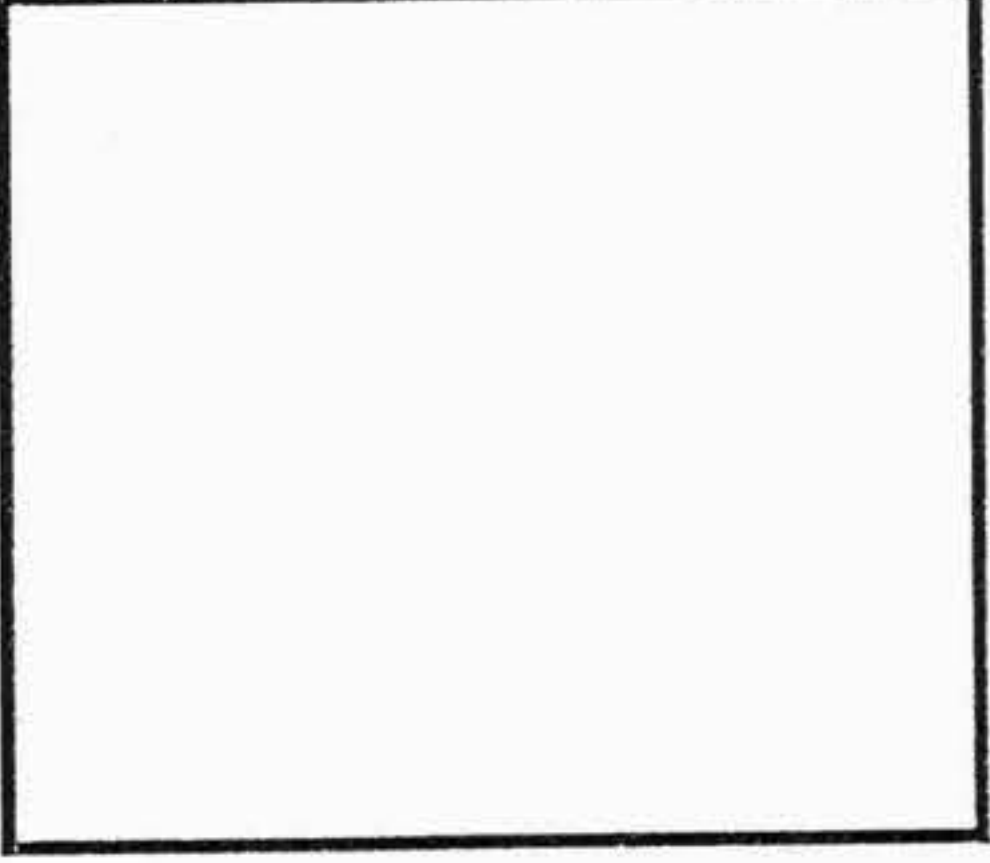
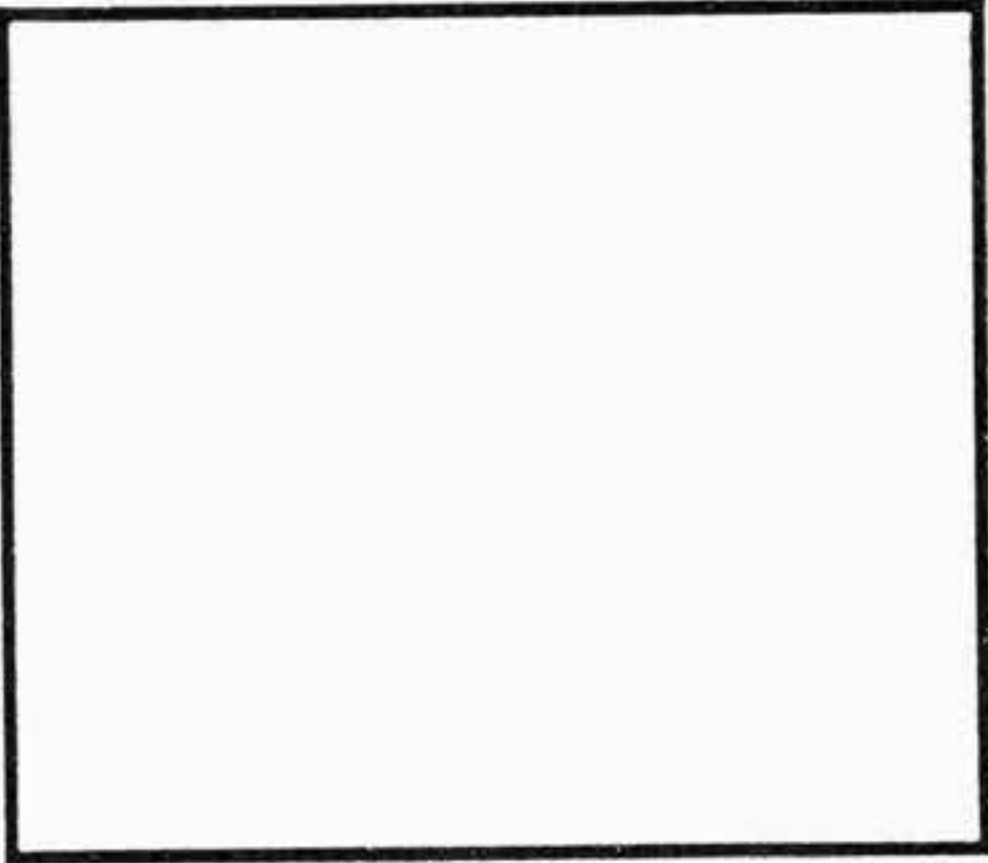
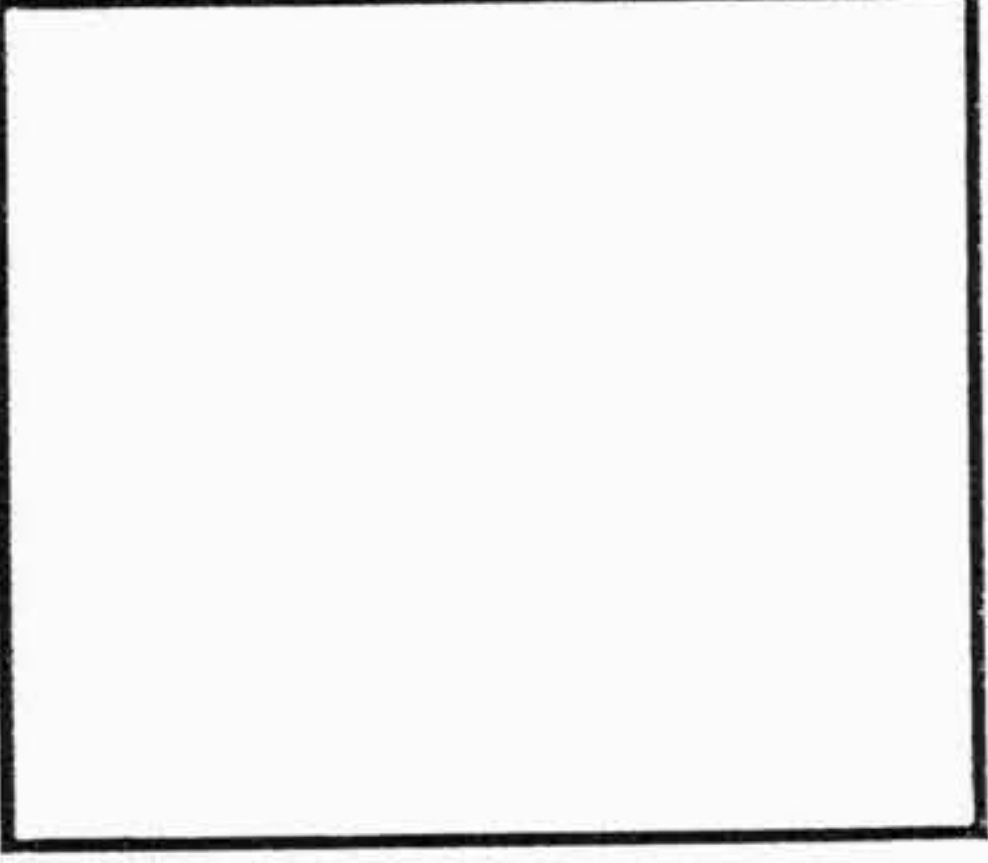
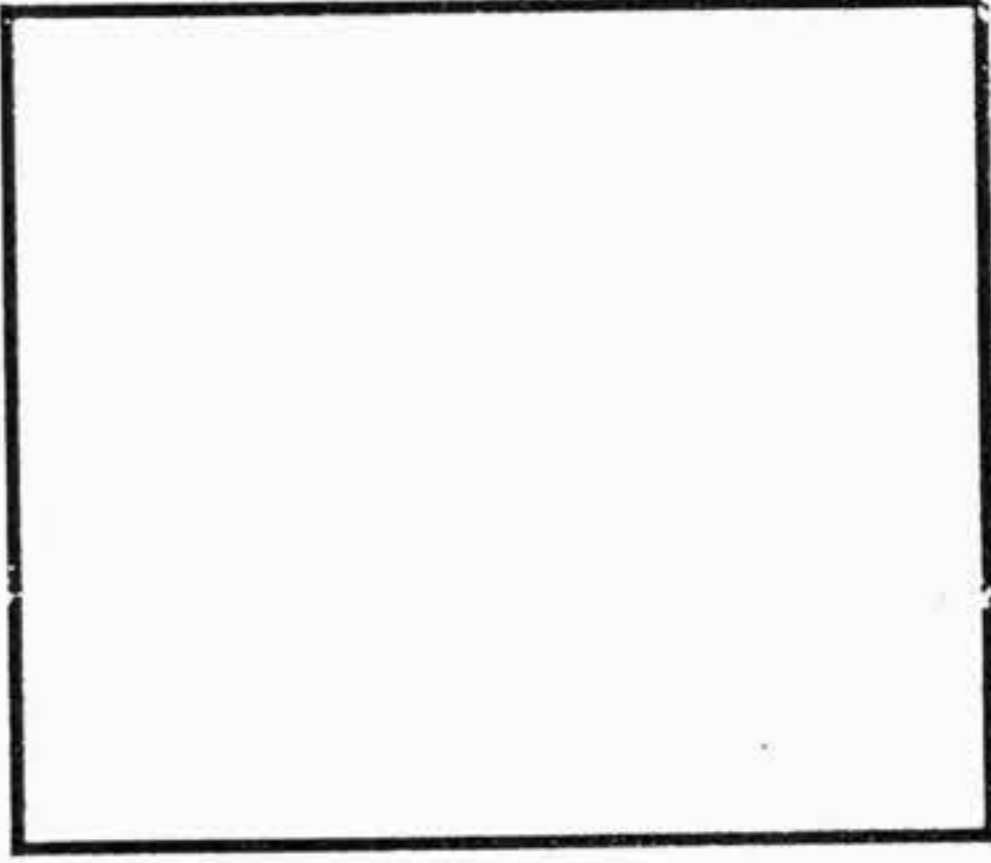
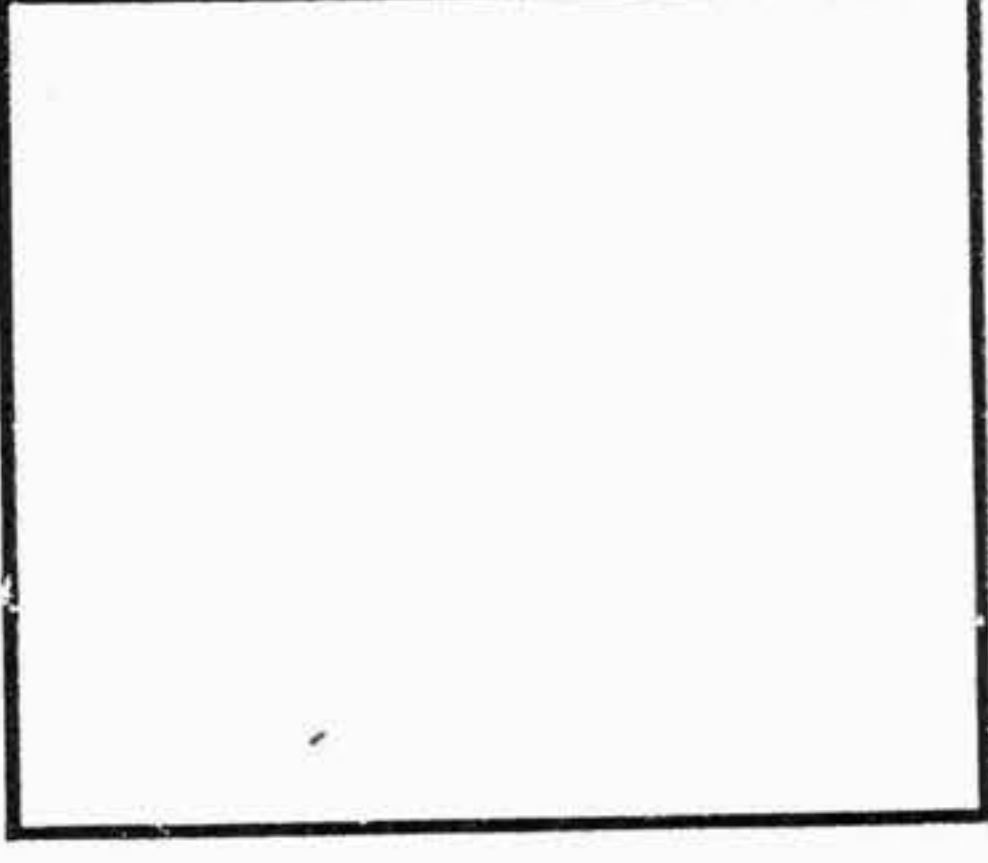

TIPO O MODELLO TYPE OU MODELE TYPE OR MODEL	MOTORE MOTEUR ENGINE	POMPA ACQUA POMPE A EAU WATER PUMP	KIT RIPARAZIONE NECESSAIRE DE REP. REPAIR KIT
		OMP REF. / O.E.M. REF	OMP REF. / O.E.M. REF
F 89 N 89	TD 120 TD 100 A	<p>317.090 423.333</p> 	<p>312.169 275.613</p> 
			
			
			

I ricambi non sono originali ma adattabili . Ogni riferimento originale é assolutamente indicativo .
 Spare parts are not original but perfectly suitable . Every original part number has to be considered for reference purpose only .

SUITABLE

VOLVO

AUTOBUS - AUTOCARS - BUSES - OMNIBUSSE

Tel:+44(0)1925 850082 Fax: +(0)44 1925 850083

www.spwaterpumps.co.uk

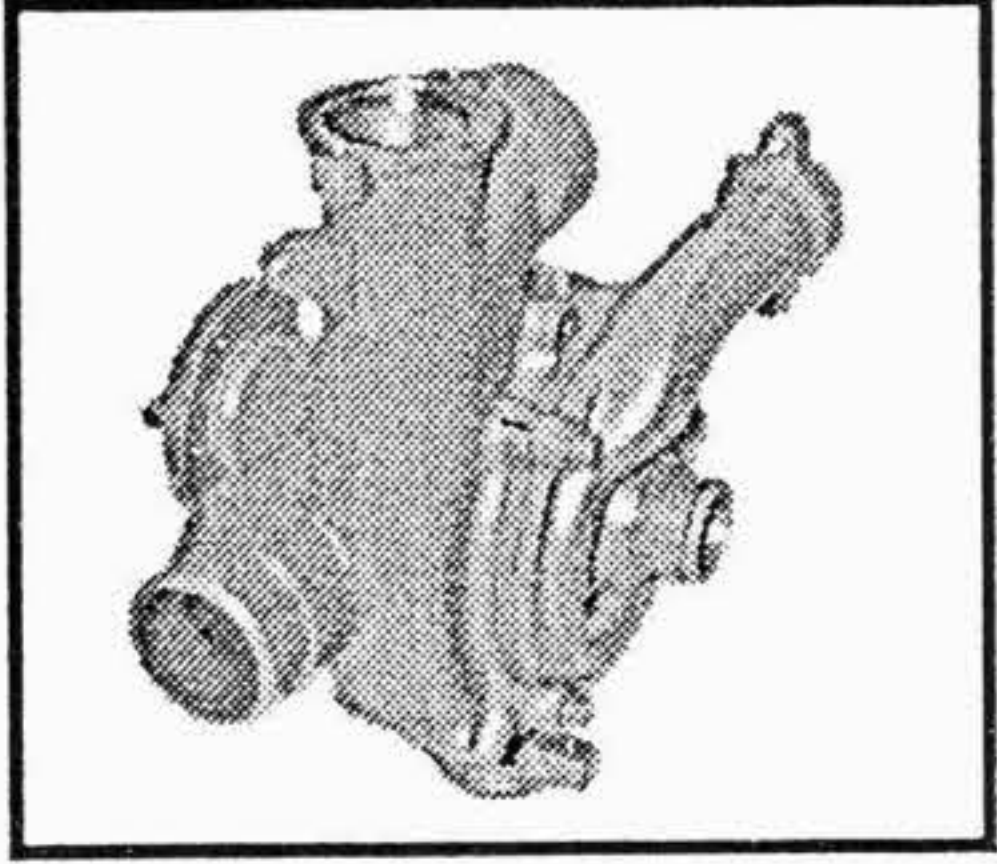
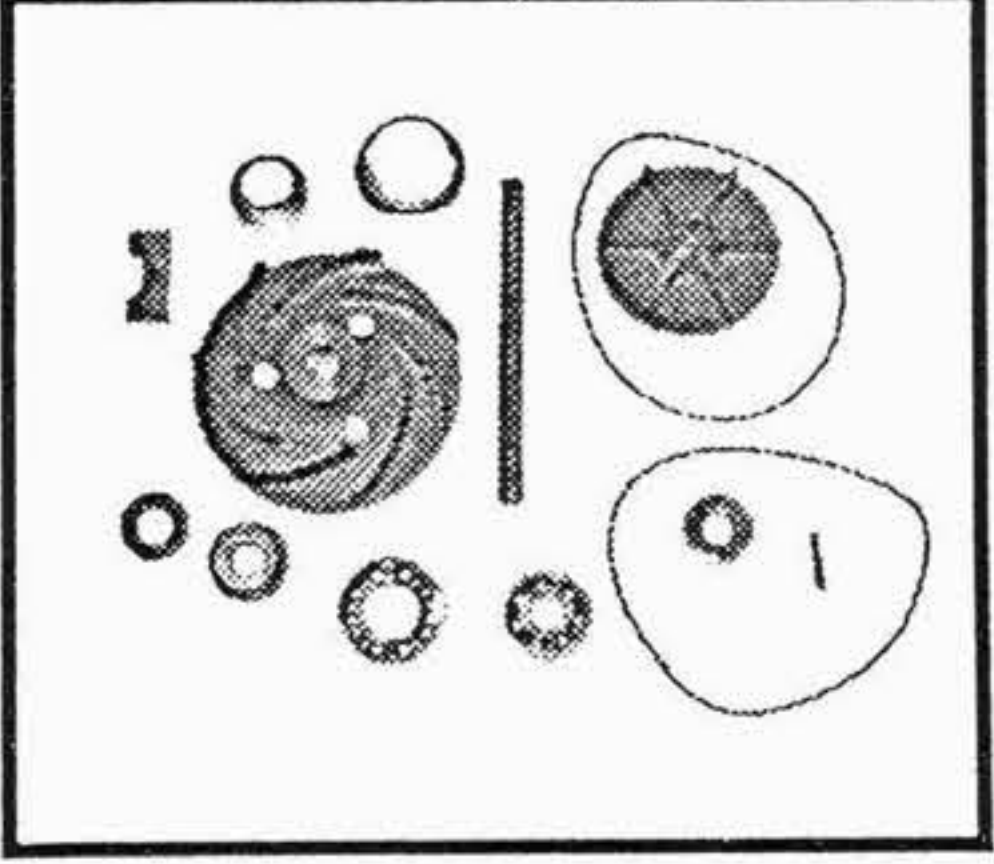
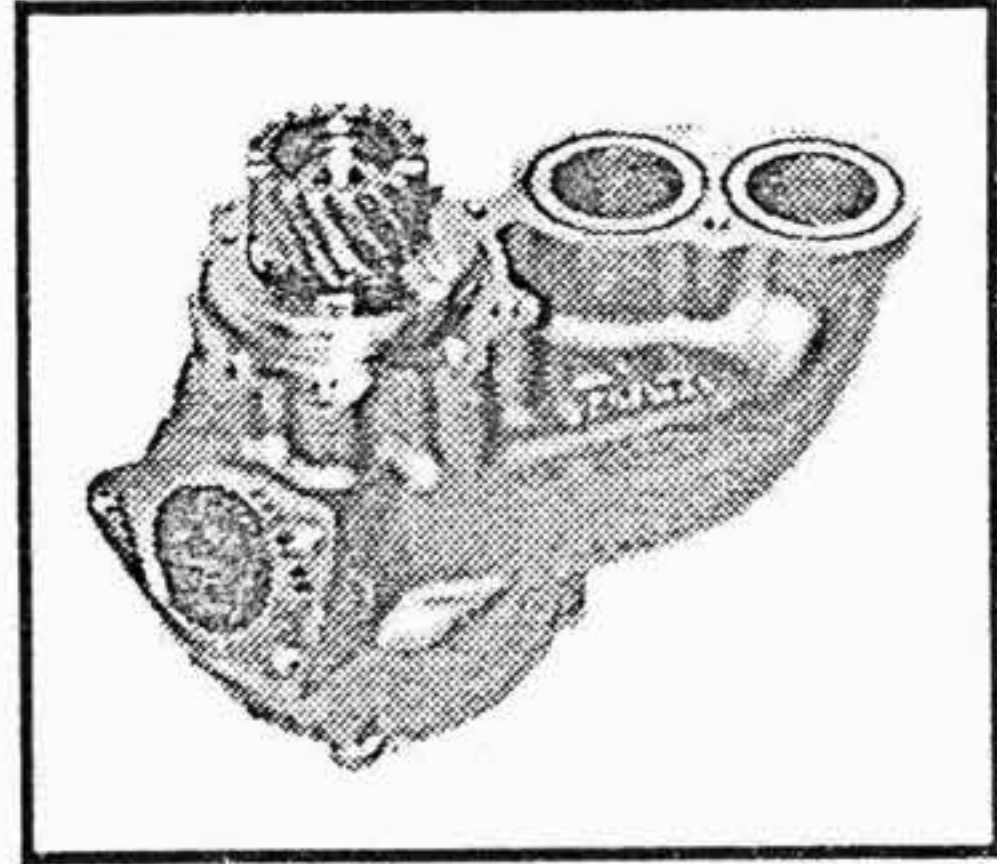
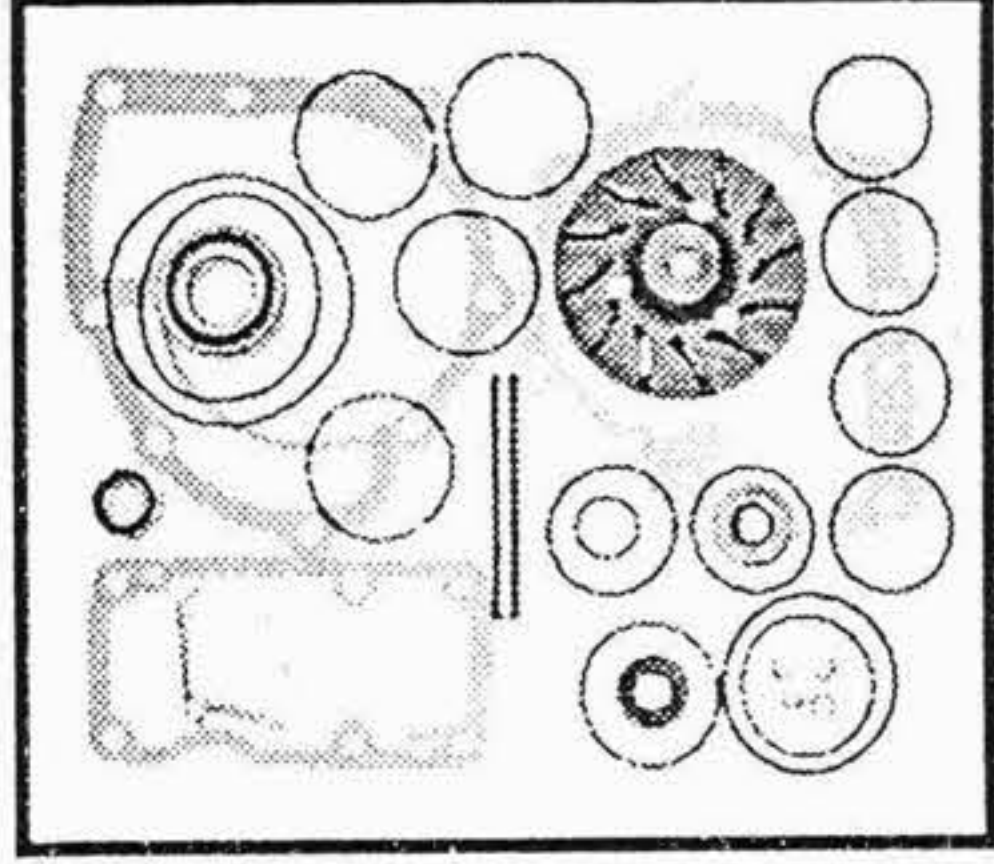
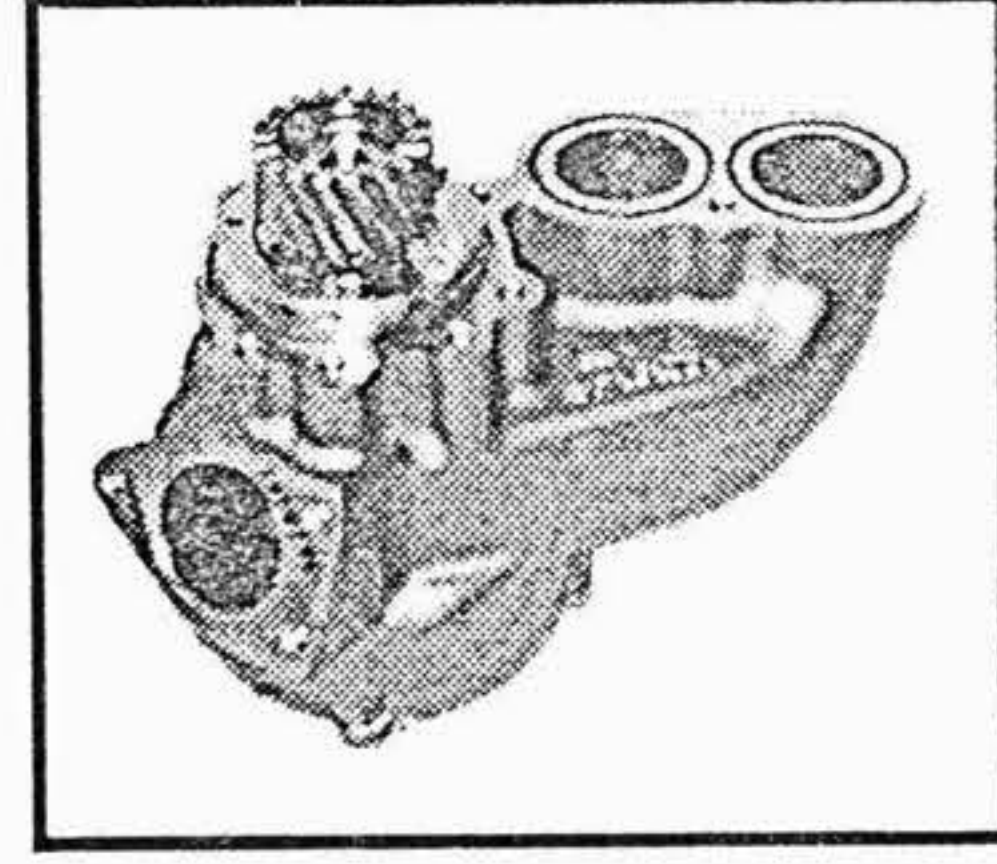
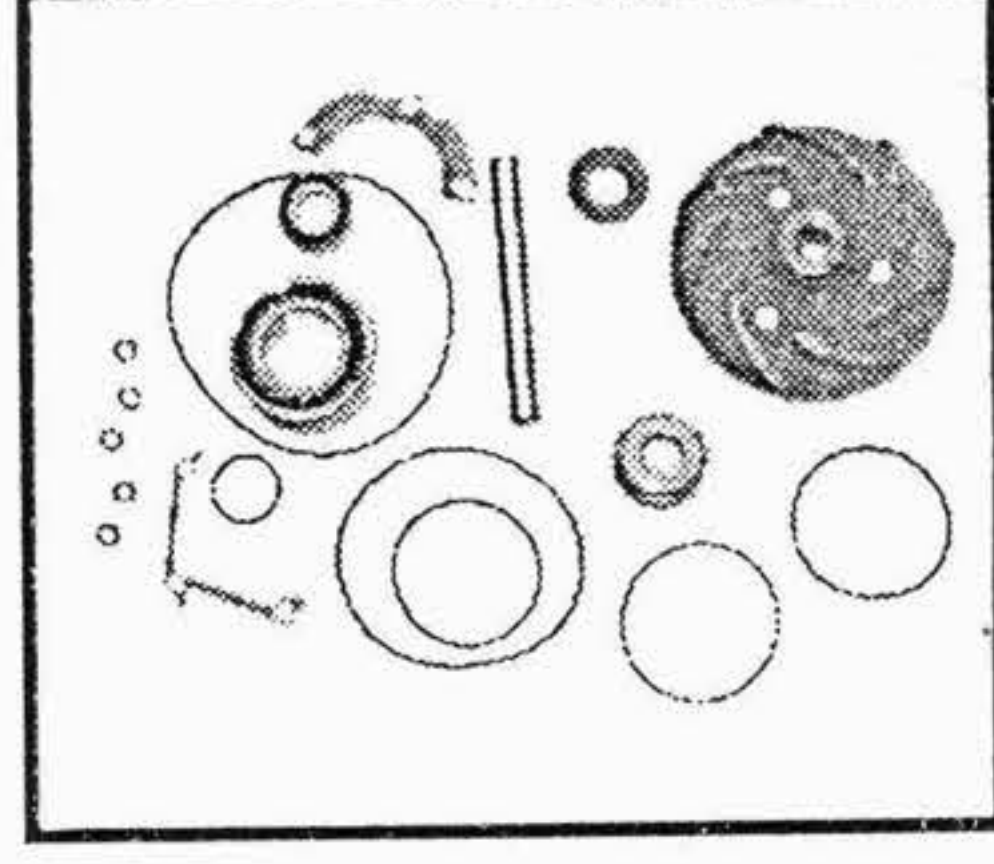
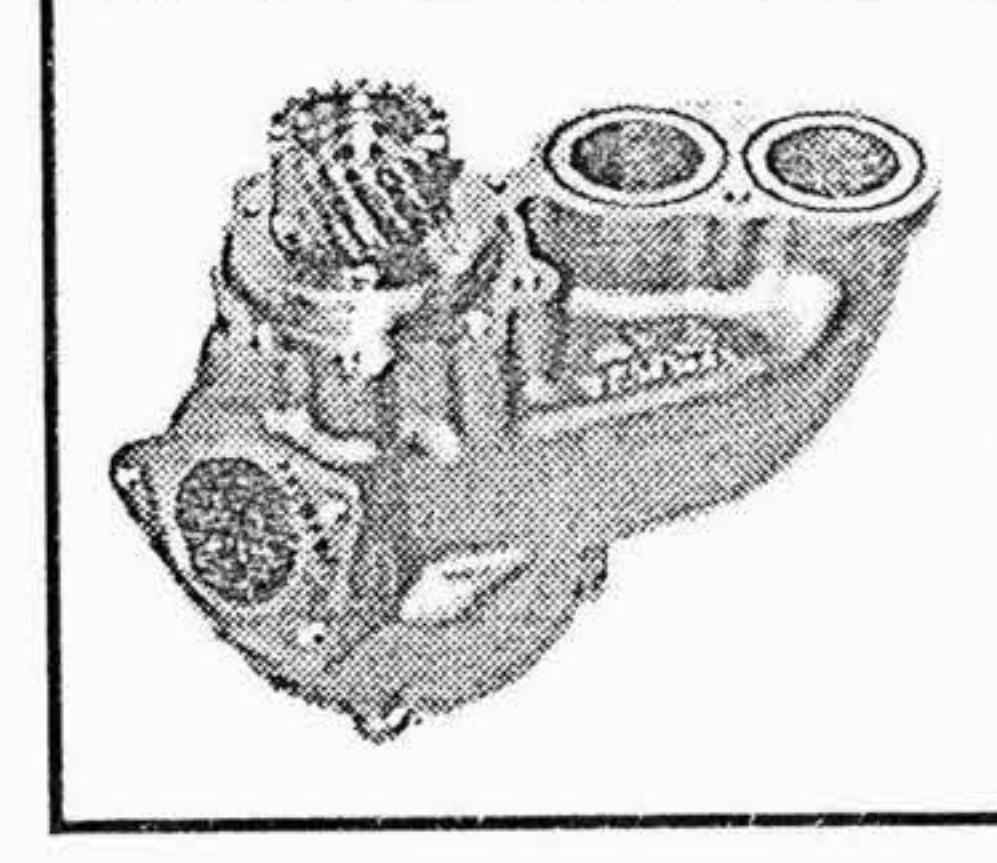
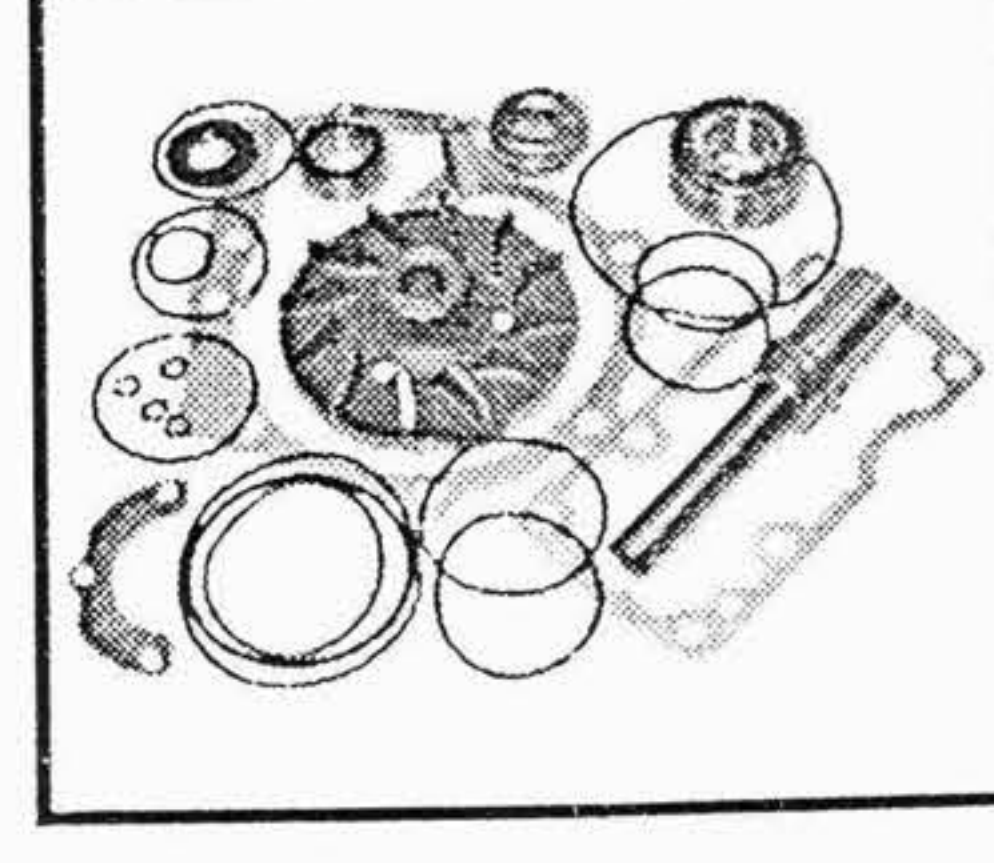

TIPO O MODELLO TYPE OU MODELE TYPE OR MODEL	MOTORE MOTEUR ENGINE	POMPA ACQUA POMPE A EAU WATER PUMP	KIT RIPARAZIONE NECESSAIRE DE REP. REPAIR KIT
B 10 B - SFL 12 B 10 B Excellence 1000 / L / Shuttle B 10 B - SL 12 B 10 M MK III B 10 R B 10 L C 10 M <div style="text-align: right; font-size: 2em; font-weight: bold; transform: rotate(-15deg);">NEW !!</div>	THD 102 KB THD 102 KD THD 102 KK THD 103 KB THD 103 KD THD 103 KF	317.290 425.268 	312.294 3097.084 
B 12 Olympian Mk II	TD 120 TD 121 TD 122 FK TD 122 FS TD 122 FL TD 122 FH	317.160 1545.261 	312.276 276.802  in alternativa / alternatively use 312.171 275.615
B 12 Olympian Mk II	TD 122 FK - OCS TD 122 FS - OCS TD 122 FL - OCS TD 122 FH - OCS	317.190 422.791 	312.175 270.791 
B 12 ---> fino al telaio N° 4999 Olympian Mk II <div style="text-align: right; font-size: 2em; font-weight: bold; transform: rotate(-15deg);">NEW !!</div>	TD 123 E TD 123	317.240 1675.945 	312.278 276.814 

I ricambi non sono originali ma adattabili . Ogni riferimento originale é assolutamente indicativo .
 Spare parts are not original but perfectly suitable . Every original part number has to be considered for reference purpose only .

SUITABLE

VOLVO

AUTOBUS - AUTOCARS - BUSES - OMNIBUSSE

Tel:+44(0)1925 850082 Fax: +(0)44 1925 850083

www.spwaterpumps.co.uk

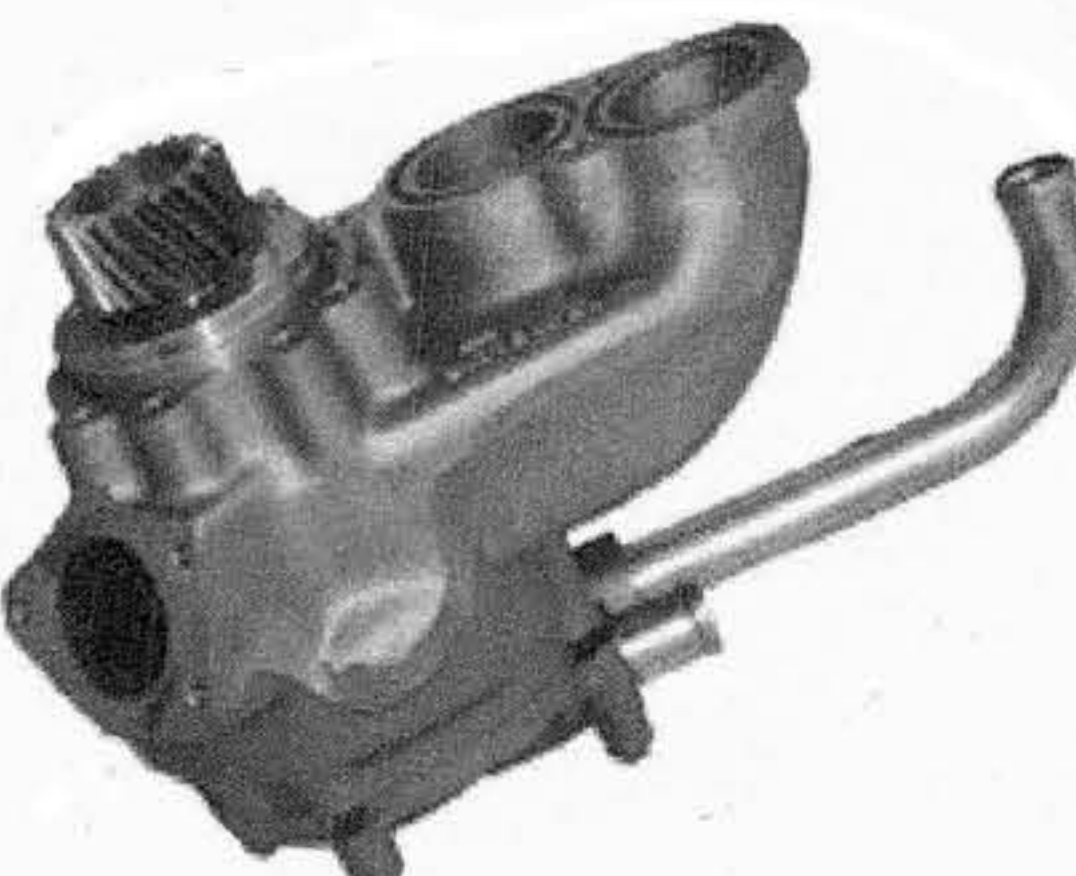
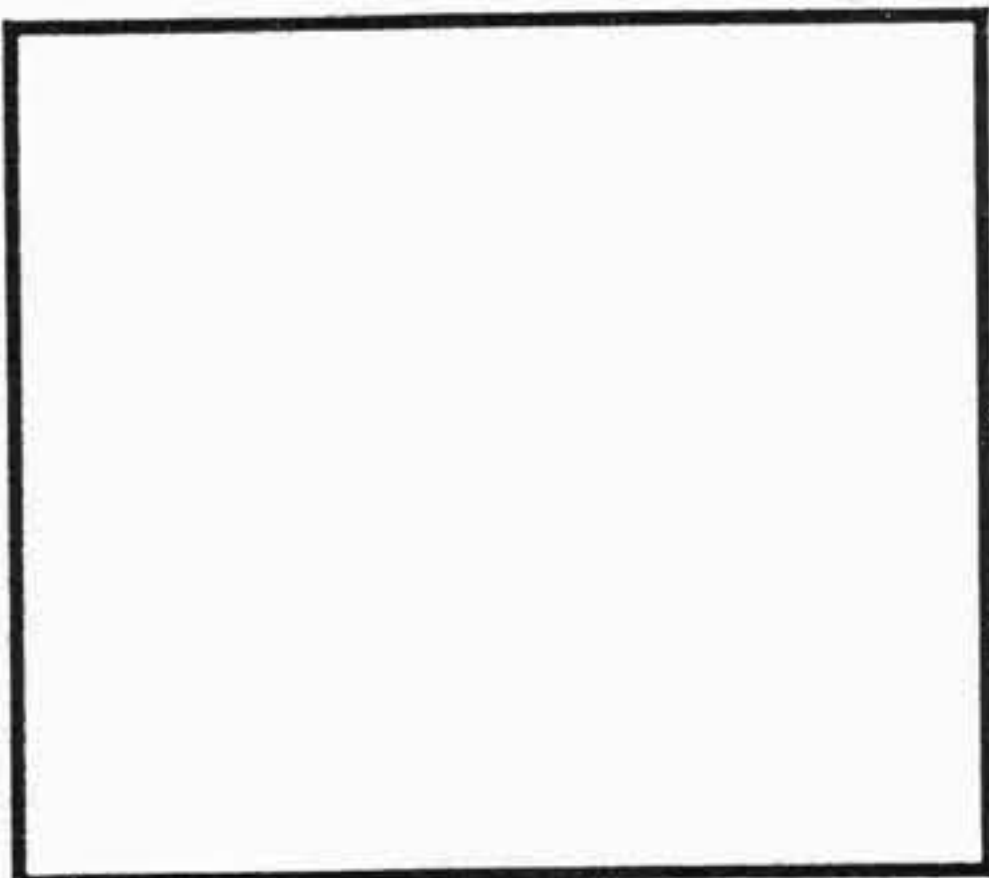
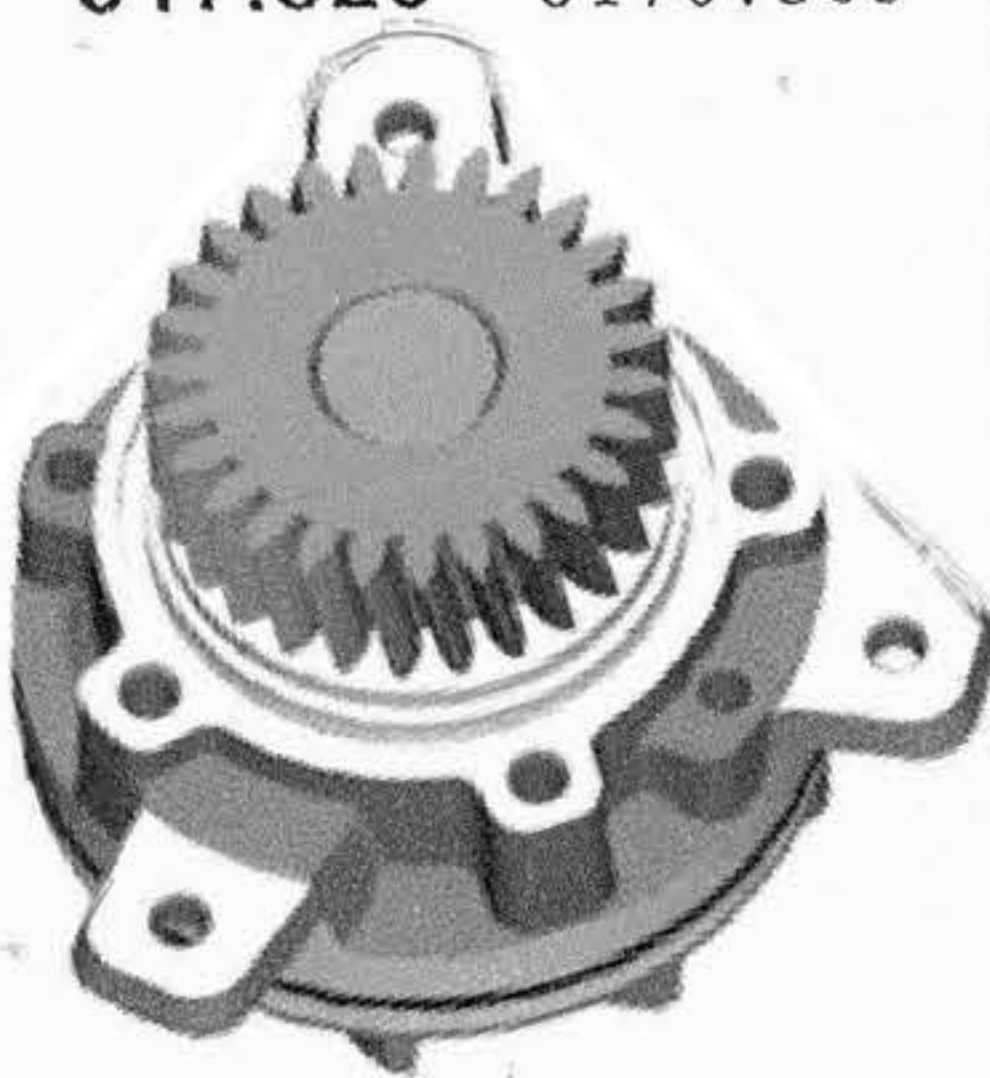
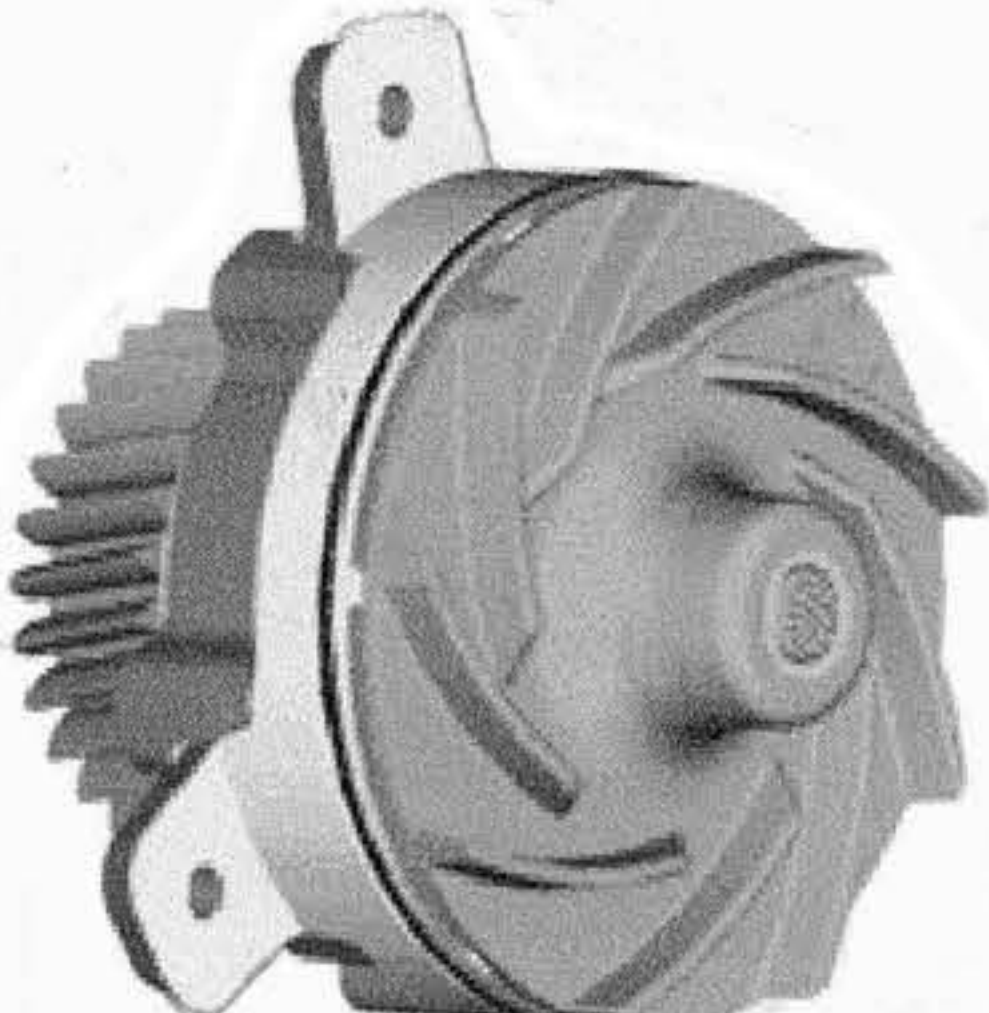
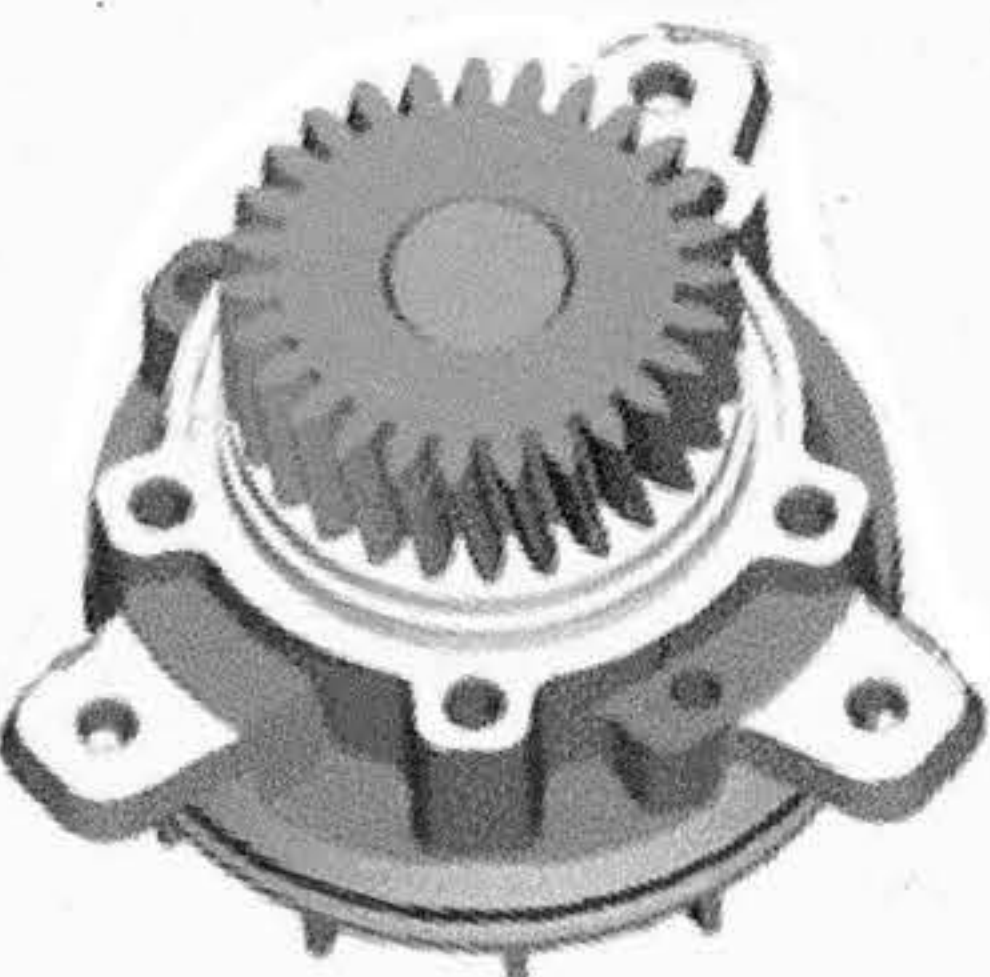
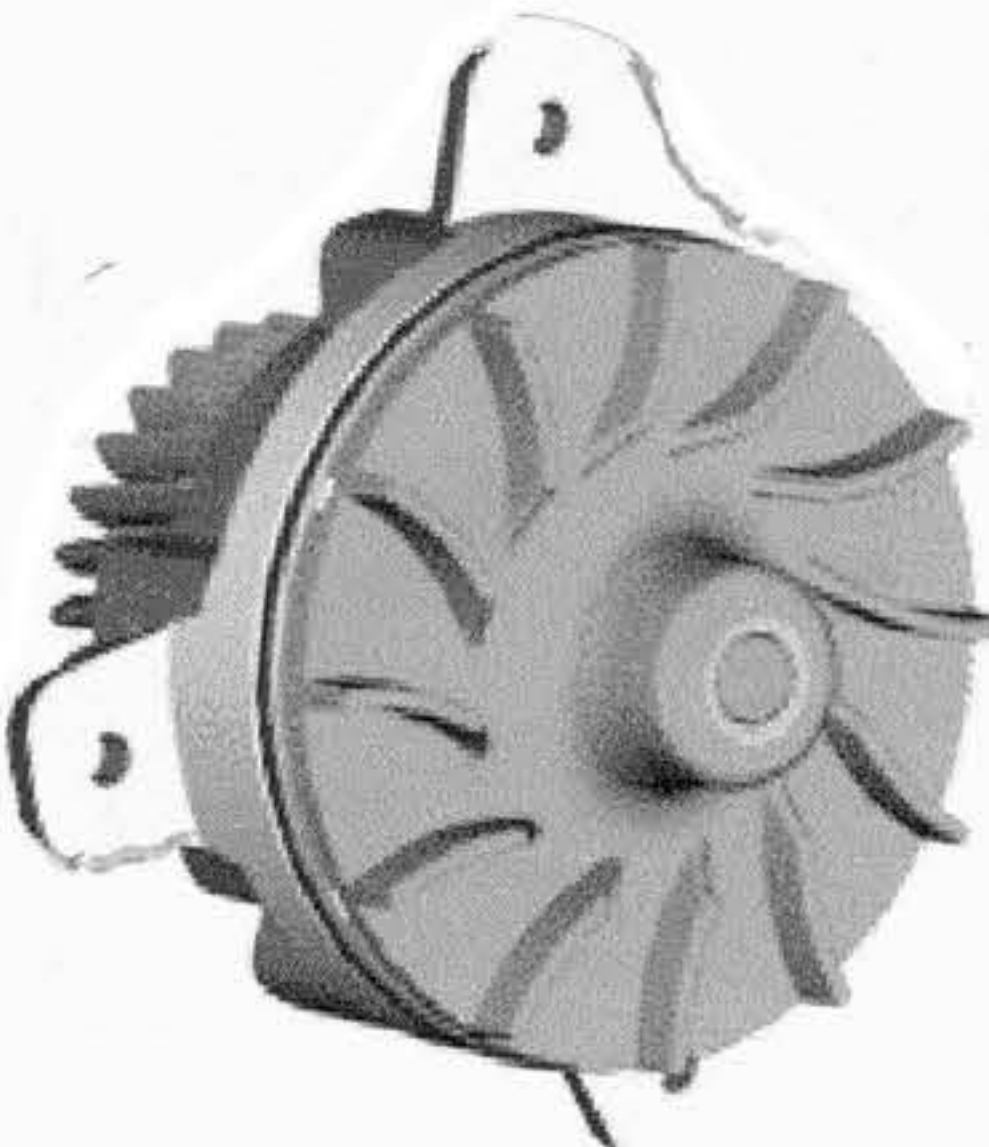
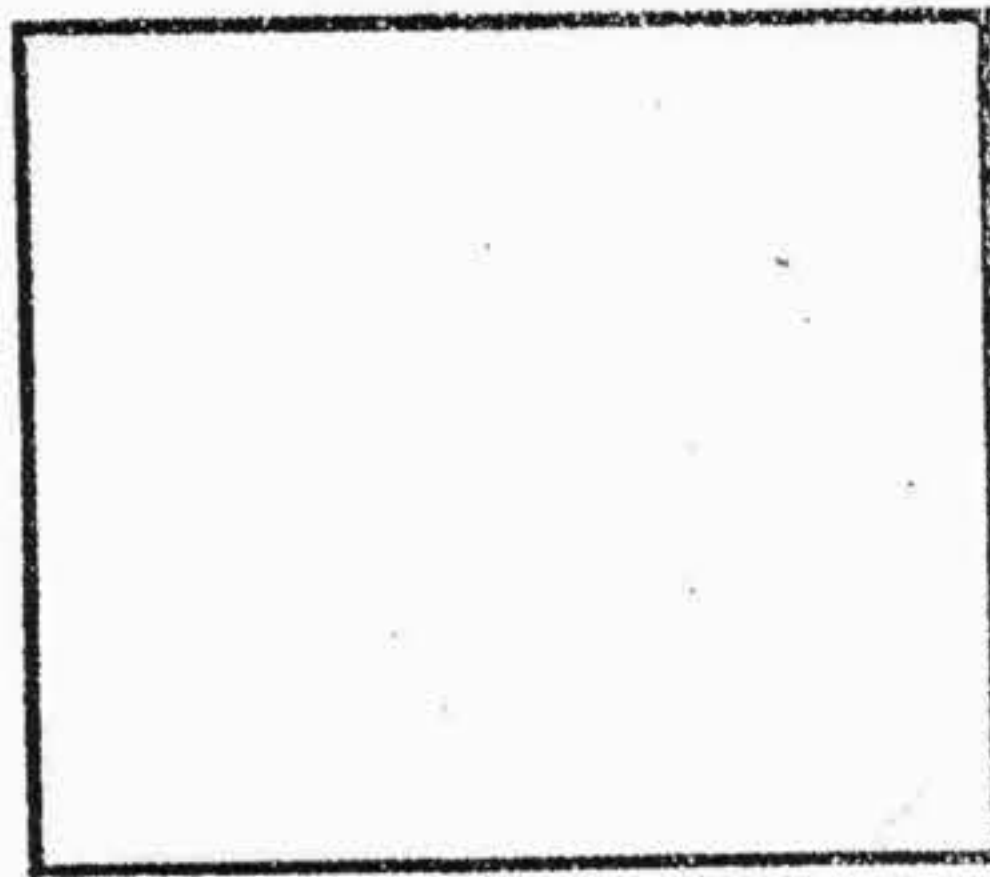

TIPO O MODELLO TYPE OU MODELE TYPE OR MODEL	MOTORE MOTEUR ENGINE	POMPA ACQUA POMPE A EAU WATER PUMP	OMP REF. / O.E.M. REF. KIT RIPARAZIONE NECESSAIRE DE REP. REPAIR KIT
B 12 OLYMPIAN Mk II	TD 102 KF D10A NEW !!	317.300 425.751  85000412	312.295 3097.368 3097402 
FH 12 dal telaio / from chassis 2911152 ---> AFTER CHASSIS No 29911152 FM 12 Per versioni con cambio manuale For vehicles with <u>manual gearbox</u> *	8113274 85000452 2073427 D 12 C NEW !!	317.320 8170.305 	
FH 12 dal telaio / from chassis 2911152 ---> FM 12 Per versioni con cambio automatico Per versioni con ritardatore VOITH For vehicles with <u>automatic gearbox</u> * For vehicles with <u>VOITH hydraulic retarder</u>	D 12 C 8112375 D 12 C NEW !!	317.330 8170.833 	
F 16 NEW !!	TD 162 F - FL TD 163 F - FL	317.260 1556.330 <div data-bbox="924 2524 1381 2916" style="border: 1px solid black; padding: 5px;">Questo complessivo pompa acqua è stato sostituito con il tipo L' Ensemble de pompe d' eau a ete remplacè par le modele This complex of water pump has been replaced by the type O.E. 8149.980 - OMP 317.270 Questa pagina resta valida per i ricambi Cette page reste valable pour les pièces de recharge . This page remain valid for the spare parts</div>	312.292 276.636 

VOLVO

Tel: +(0)44 1925 850082 Fax: +(0)44 1925 850083
www.spwaterpumps.co.uk



TYPE OR MODEL	ENGINE	WATER PUMP	WATER PUMP
VOLVO B10M MK 111 8112356	UK Version ZSP1933	317.275 	317.275 
FM7 B6, B7, B7L, B7R HIGH OUTPUT 85000387	TD 73 ZSP1930 Latest High Output FM7, B7I	317.350 	317.298 
VOLVO FM9 D9A 85000214 85000062 85000486 20744939 3161436	D9A ZSP1945 AUTOBUS - 8300, 9300	ZSP1945 AWAITING PHOTO	
VOLVO B12M, B12B 85000412 85000476 85000657 85000337 1549491 8170833 8170305 20592629 20568564	B12B, B12M ZSP1943 B12, DH12D DH12C AUTOBUS- 9700	ZSP1942 AWAITING PHOTO	

VOLVO

Tel: +(0)44 1925 850082 Fax: +(0)44 1925 850083
www.spwaterpumps.co.uk



TYPE OR MODEL	ENGINE	WATER PUMP	REPAIR KIT