

# WATER PUMP CATALOGUE

## TRACTOR & PLANT SECTION

### ALL MAKES

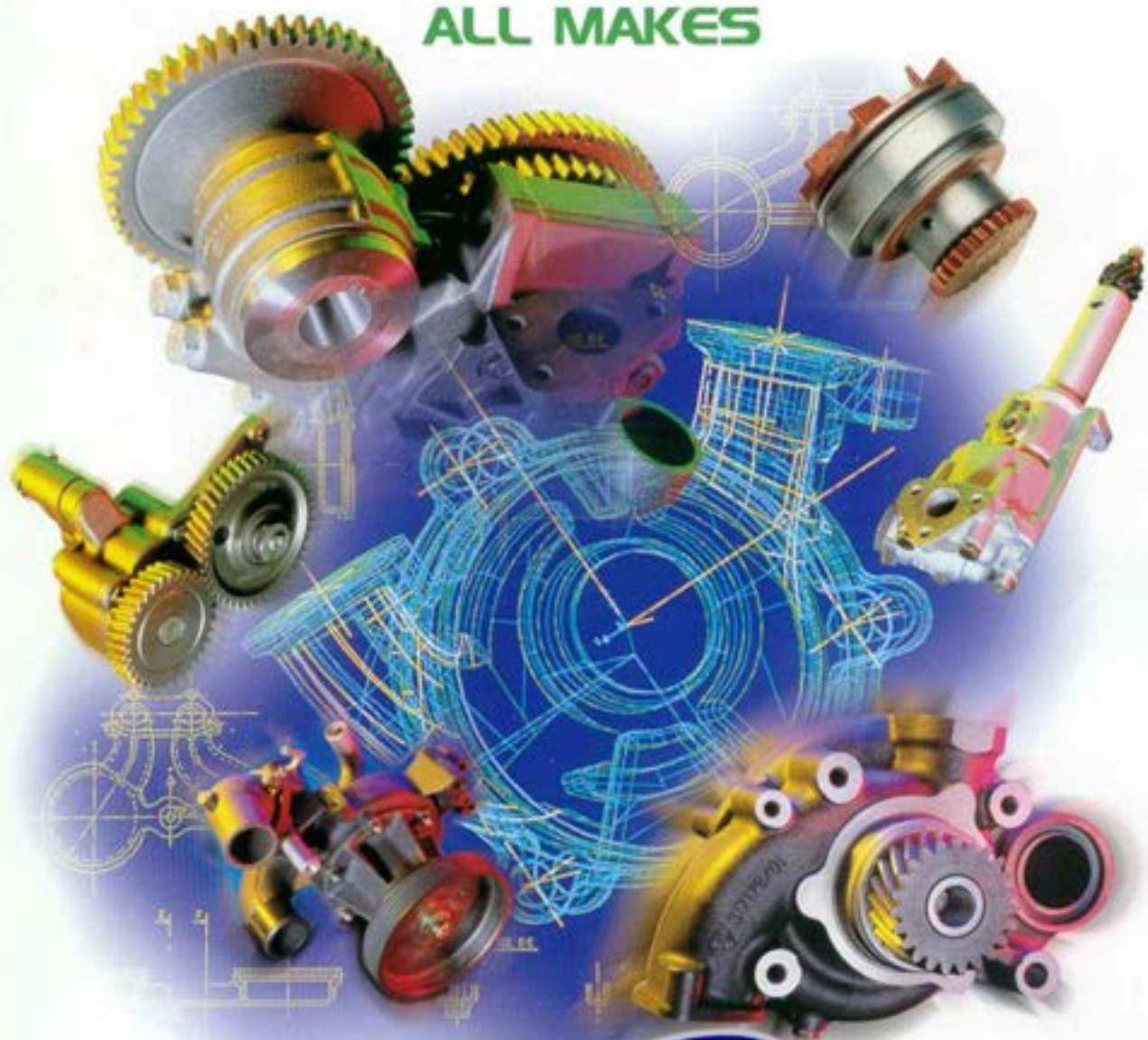

# SP

## WATER PUMPS

### WEB EDITION

S.P. WATER PUMPS LTD

18 Tatton Court, Kingsland Grange, Woolston,  
Warrington, Cheshire. ENGLAND. WAI 4RR

TEL: +44(0)1925 850082 FAX: +44(0)1925 850083

Email:sales@spwaterpumps.co.uk Web Site:www.spwaterpumps.co.uk



Tel: +44(0)1925 850082  
Fax: +44(0)1925 850083

## TRACTOR & PLANT SECTION

# WATER PUMP INDEX

<b>BELARUS</b>	<b>Section 04</b>
<b>CUMMINS</b>	<b>Section 09</b>
<b>EBRO</b>	<b>Section 14</b>
<b>FENDT XAVER</b>	<b>Section 15</b>
<b>NEW HOLLAND</b>	<b>Section 16</b>
<b>FORD</b>	<b>Section 17</b>
<b>HANOMAG</b>	<b>Section 19</b>
<b>I.H. - CASE</b>	<b>Section 22</b>
<b>JOHN DEERE</b>	<b>Section 24</b>
<b>LANDINI</b>	<b>Section 29</b>
<b>MB TRAC   UNIMOG</b>	<b>Section 33</b>
<b>MASSEY FERGUSON</b>	<b>Section 34</b>
<b>PERKINS</b>	<b>Section 34</b>
<b>RENAULT D.M.A</b>	<b>Section 36</b>
<b>SAME DEUTZ-FAHR</b>	<b>Section 38</b>
<b>STEYR</b>	<b>Section 39</b>
<b>VOLVO BM</b>	<b>Section 39</b>
<b>VOLVO</b>	<b>Section 41</b>
<b>VOLVO PENTA</b>	<b>Section 41</b>



**SECTION 04**

**APPLICATION**

**BELARUS**

**WATER PUMPS WASSERPUMPEN  
POMPE A EAU BOMBA DE AGUA  
POMPA ACQUA**

**S.P. WATER PUMPS LTD  
18 Tatton Court, Kingsland Grange, Woolston,  
Warrington, Cheshire. ENGLAND. WAI 4RR  
TEL: +44(0) 1925 850082 Fax: +44(0) 1925 850083  
Email:sales@spwaterpumps.co.uk Web Site:www.spwaterpumps.co.uk**

SUITABLE



# BELARUS

TRACTORS

Tel: +44(0)1925 850082 Fax: +(0)44 1925 850083

www.spwaterpumps.co.uk

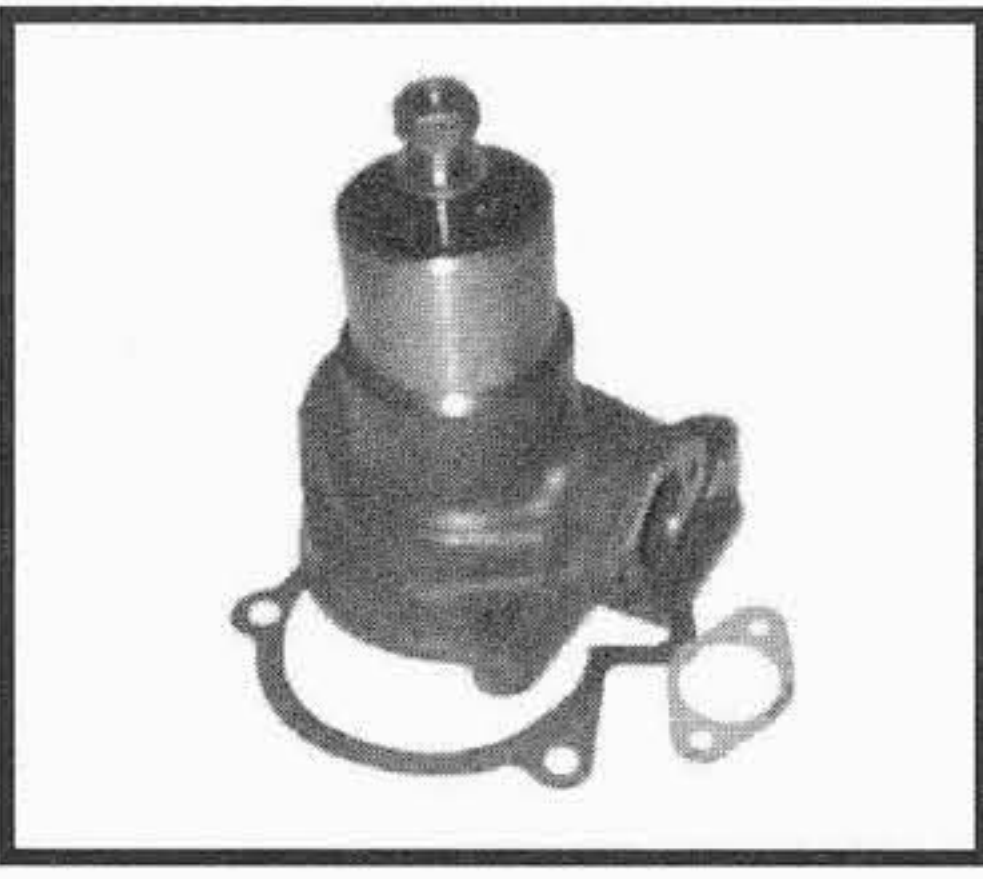
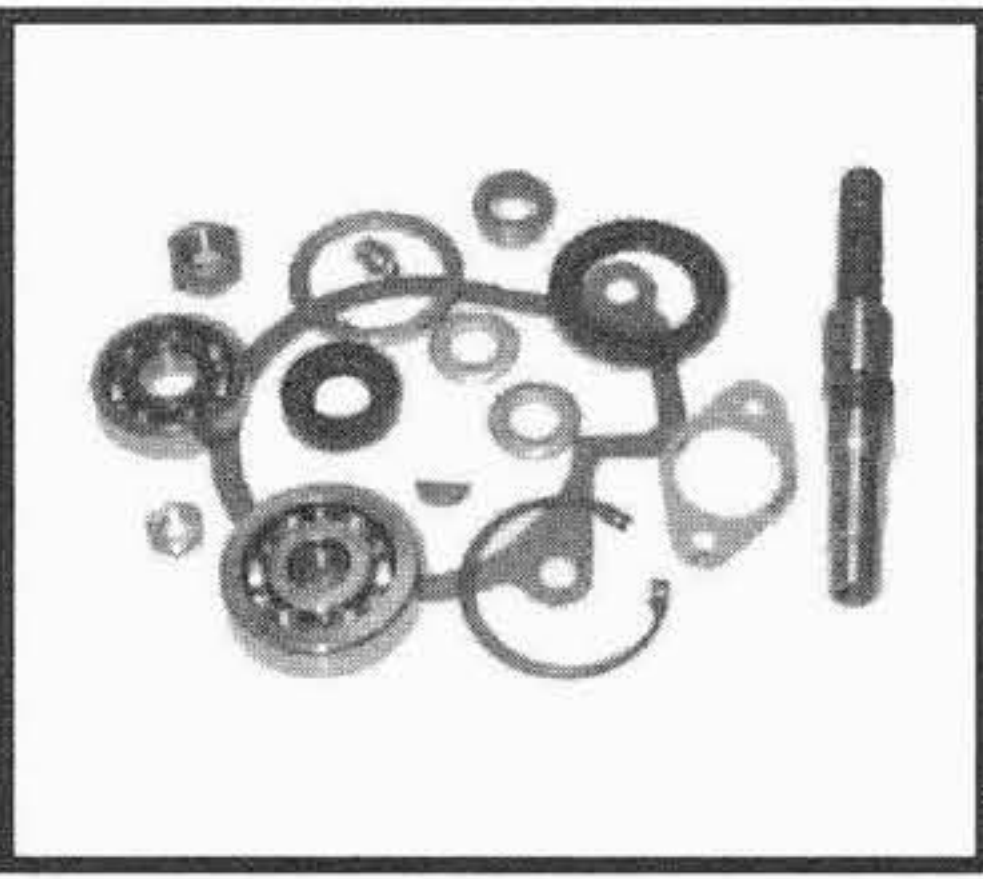
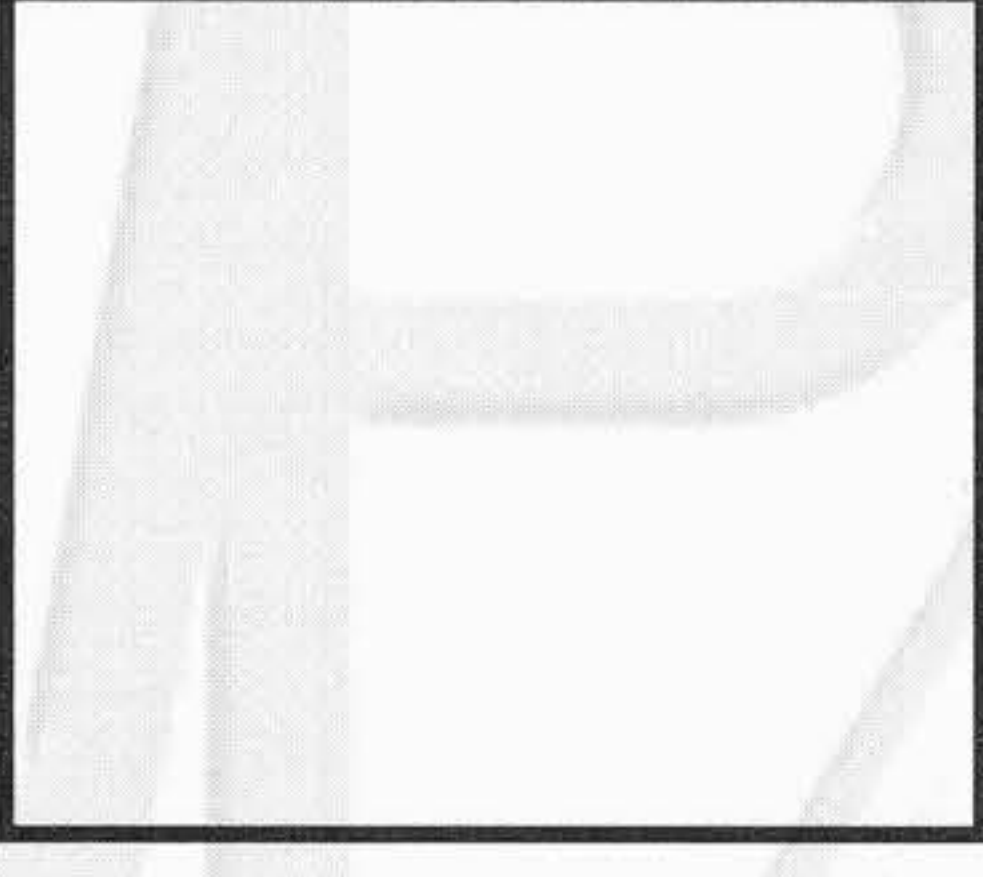
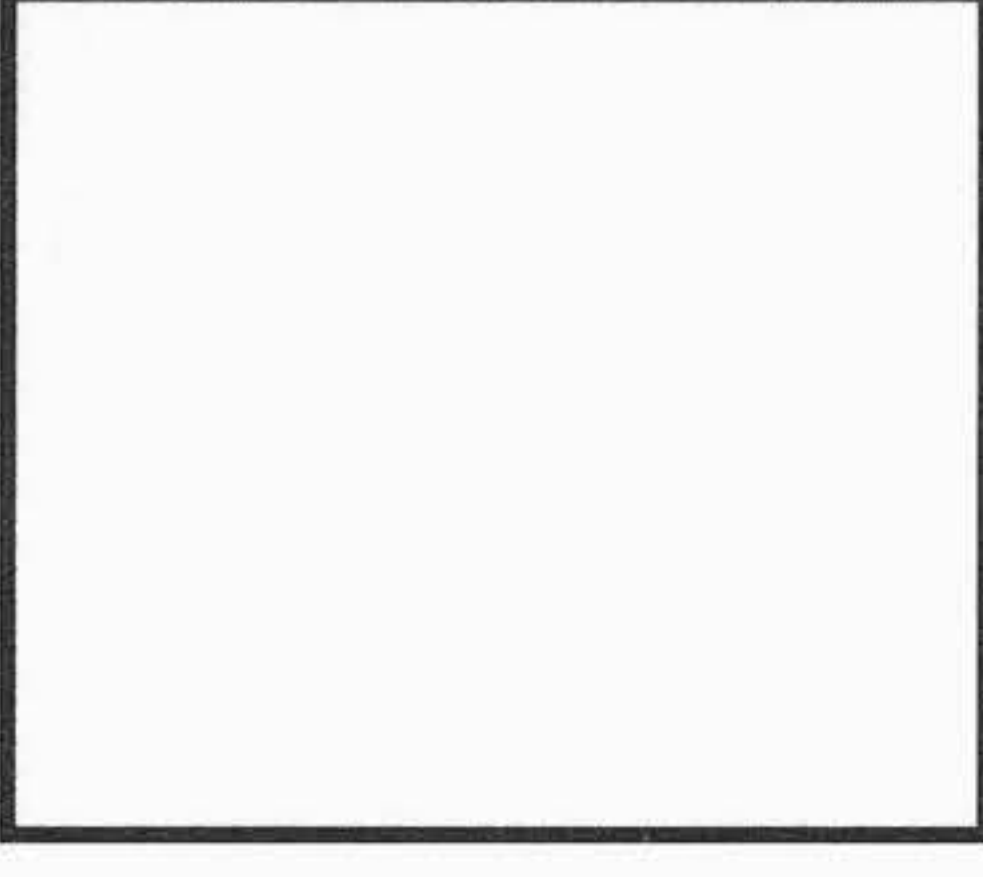
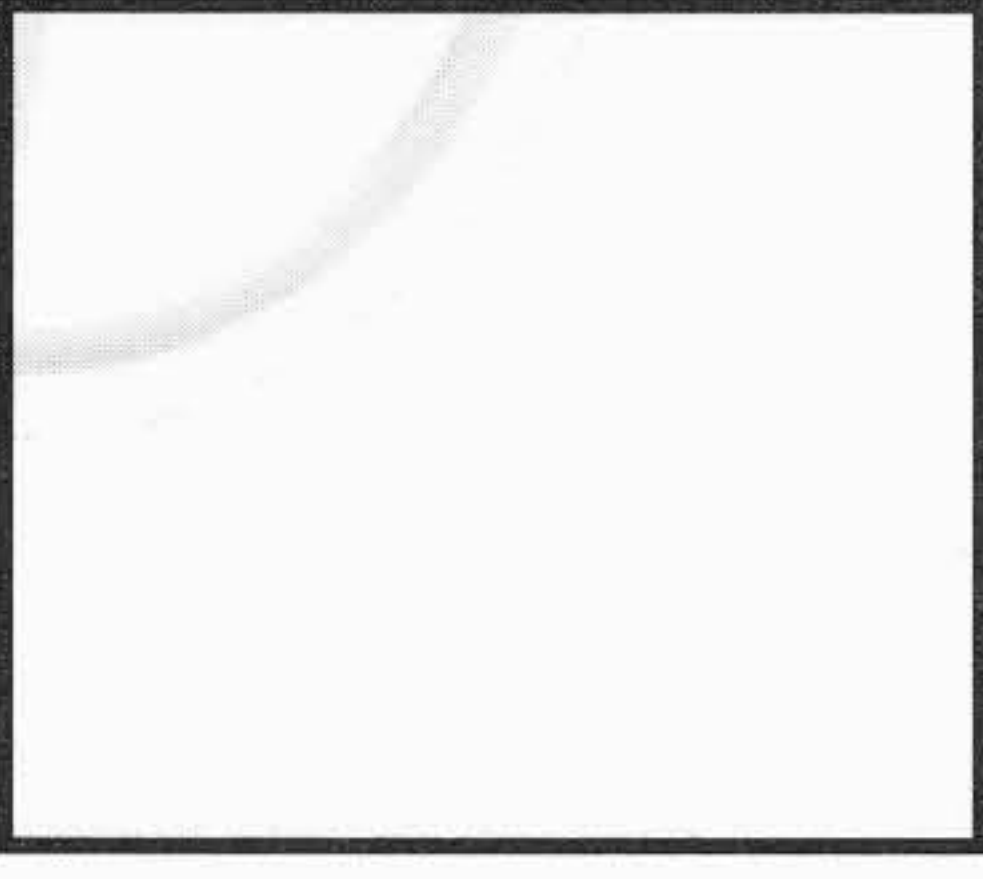

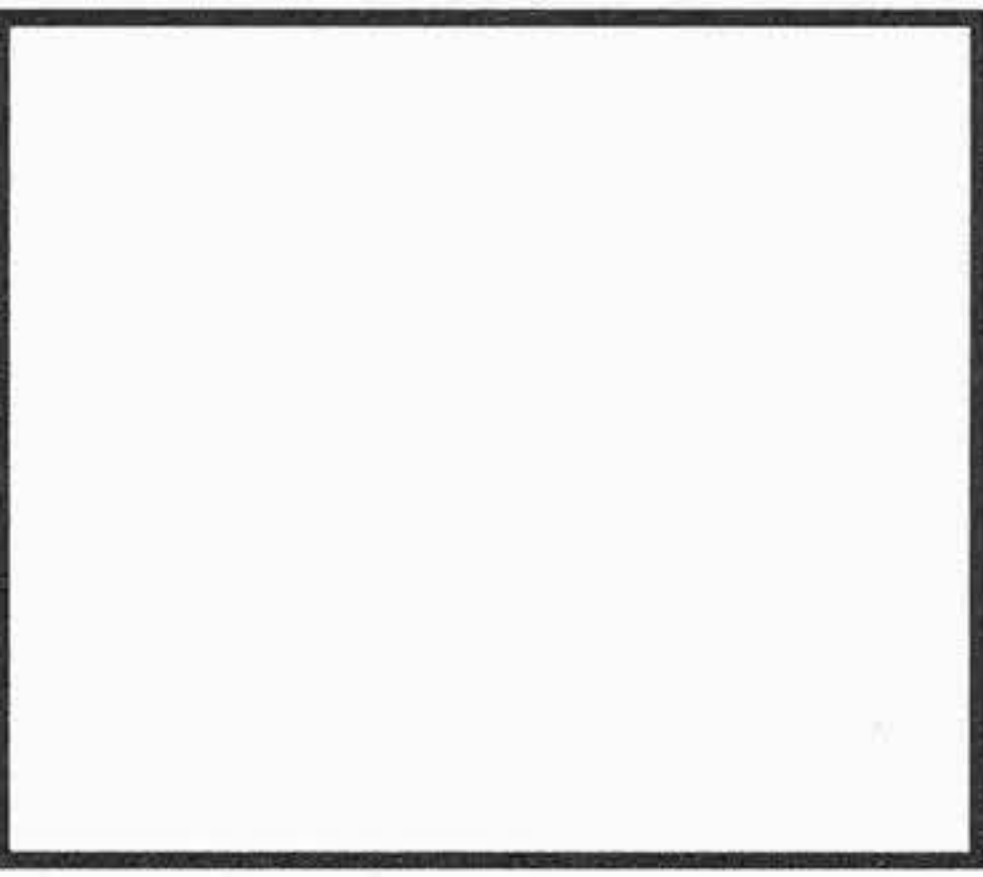
TIPO O MODELLO TYPE OU MODELE TYPE OR MODEL	MOTORE MOTEUR ENGINE	POMPA ACQUA POMPE A EAU WATER PUMP OMP REF. / O.EM. REF	KIT RIPARAZIONE NECESSAIRE DE REP. REPAIR KIT OMP REF. / O.EM. REF
MTZ 50 - MTZ 50 JI  MTZ 52 - MTZ 52 JI		<p style="text-align: center;"><b>330.100</b>      130701A</p> 	<p style="text-align: center;"><b>332.220</b>      -</p> 
			
			
			

I ricambi non sono originali ma adattabili . Ogni riferimento originale é assolutamente indicativo .  
Spare parts are not original but perfectly suitable . Every original part number has to be considered for reference purpose only .



## **SECTION 22**

# **APPLICATION**

# CASE

**CASE IH  
CASE POCLAIN  
IHC**

**WATER PUMPS WASSERPUMPEN  
POMPE A EAU BOMBA DE AGUA  
POMPA ACQUA**

**S.P. WATER PUMPS LTD  
18 Tatton Court, Kingsland Grange, Woolston,  
Warrington, Cheshire. ENGLAND. WAI 4RR  
TEL: +44(0) 1925 850082 Fax: +44(0) 1925 850083  
Email:sales@spwaterpumps.co.uk Web Site:www.spwaterpumps.co.uk**

TAVOLE DI CONVERSIONE  
TABLE DE CONVERSION  
CONVERSION TABLE

CASE



NUMERO ORIGINALE NUMERO ORIGINAL ORIGINAL NUMBER	NUMERO SOSTITUTIVO REPLACE PAR NUMERO REPLACED BY NUMBER	RIFERIMENTO OMP REFERENCE OMP OMP REFERENCE
A77703	J802358	
A77704	J802479	
J802358		1321.020
J802479		1321.025
672644C93	673162C92	
673162C91	673162C92	
673162C92	673162C93	
673162C93	673162C94	
673162C94		321.110
673623C91	673162C92	
675806C1	673162C92	
677415C93	673162C92	
703820R94	703820R95	
703820R95	3065132R92	
710353R1		321.017
710358R4		321.017
710359R1	760201R1	
710361R1		321.012
711114R12		321.037
712612R95		321.038
713876R1		321.013
716410R98	716410R99	
716410R99		321.056
716411R1		321.053
716866R23		321.039
718891R97		321.020
718892R1		321.015
749908C91	673162C92	
749909C91	673162C92	
760205R1		321.019
763613R95		321.030
764954R1		321.007
787579R2		321.006
933031R1		321.009
1094012R91	1094012R92	
1094012R92		322.179
1094021R91		322.165
3052183R93	3052183R94	
3052183R94		322.167
3055177R1		321.033
3055188R1		321.003
3055192R91		321.002
3055211R2		321.011
3055259R91	3132112R91	
3055260R1		321.046
3055285R92		322.166
3055285R93	3055285R94	

NUMERO ORIGINALE NUMERO ORIGINAL ORIGINAL NUMBER	NUMERO SOSTITUTIVO REPLACE PAR NUMERO REPLACED BY NUMBER	RIFERIMENTO OMP REFERENCE OMP OMP REFERENCE
3055285R94		322.189
3055308R1		321.008
3065132R92		321.040
3118125R91		329.490
3118126R91		322.183
3119778R92		321.050
3132112R91		321.005
3132146R1		321.066
3132148R1	3132146R1	
3132676R93		321.060
3132677R2	3132677R4	
3132677R4		321.001
3132677R21	3132677R41	
3132677R41		321.047
3132678R1		321.061
3132738R93		321.010
3132739R92	3132739R93	
3132739R93		321.090
3132741R93		321.000
3136053R92		321.080
3136217R92		321.095
3136218R1		321.054
3138936R92		321.075
3138937R1		321.076
3144456R93		321.085
3144458R93		321.105
3144609R1	3144609R3	
3144609R3		321.064
3144661R93		321.070
3218038R93		321.100
3218392R2		321.004
3218765R91		321.063
3218766R1		321.051
3218767R92	3218769R92	
3218769R91	3218769R92	
3218769R92		321.065
3218772R1		321.062

OGNI RIFERIMENTO ORIGINALE E' ASSOLUTAMENTE INDICATIVO. CHAQUE REFERENCE ORIGINAL EST ABSOLUMENT INDICATIVE. EVERY ORIGINAL PART NUMBER HAS TO BE CONSIDERED FOR REFERENCE PURPOSE ONLY.

SUITABLE

# CASE IH

Tel: +44(0)1925 850082 Fax: +(0)44 1925 850083  
www.spwaterpumps.co.uk

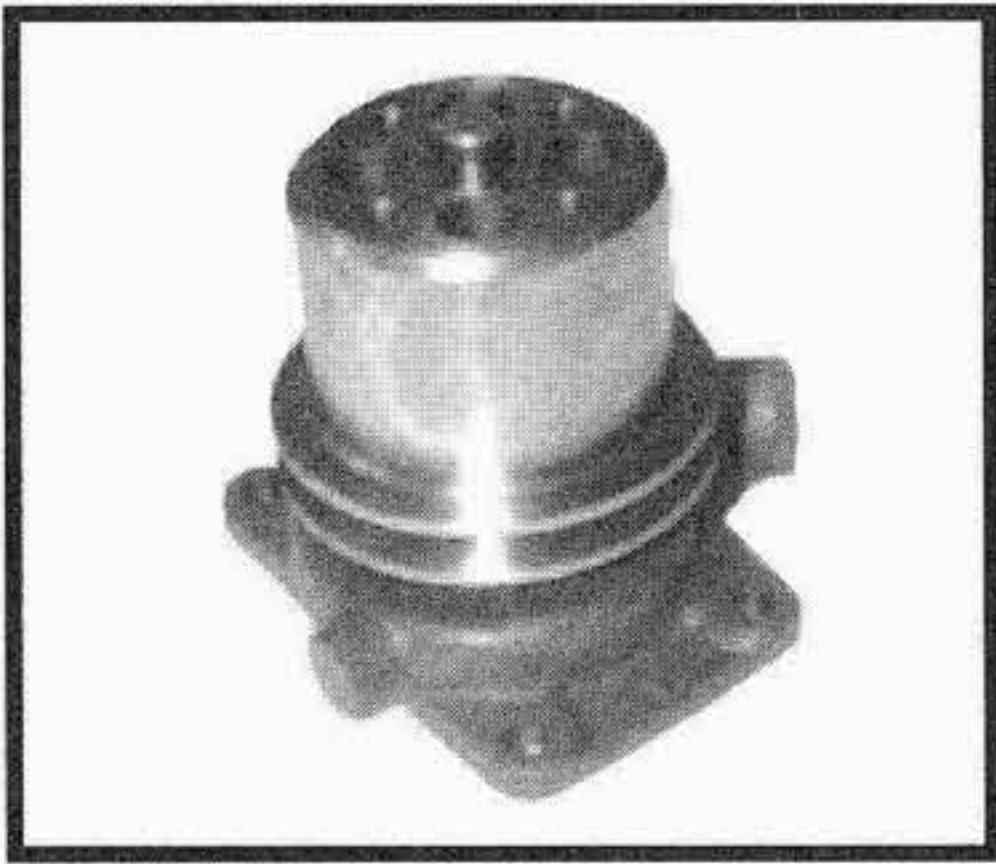
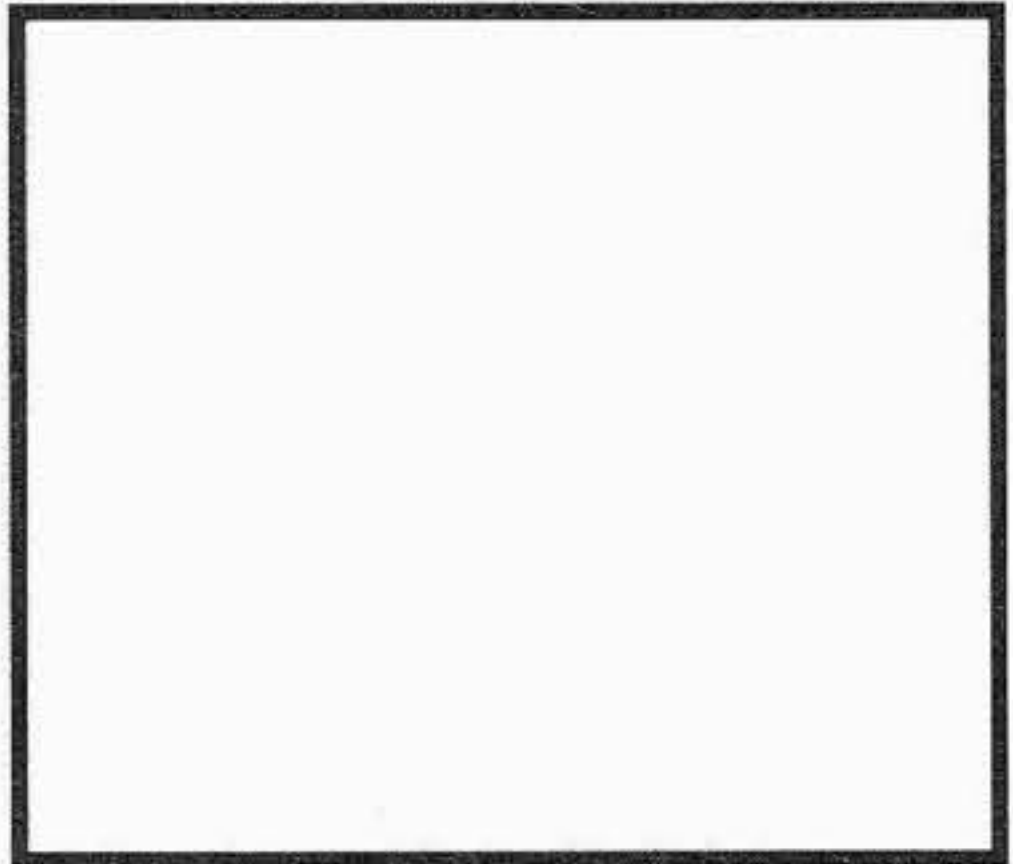
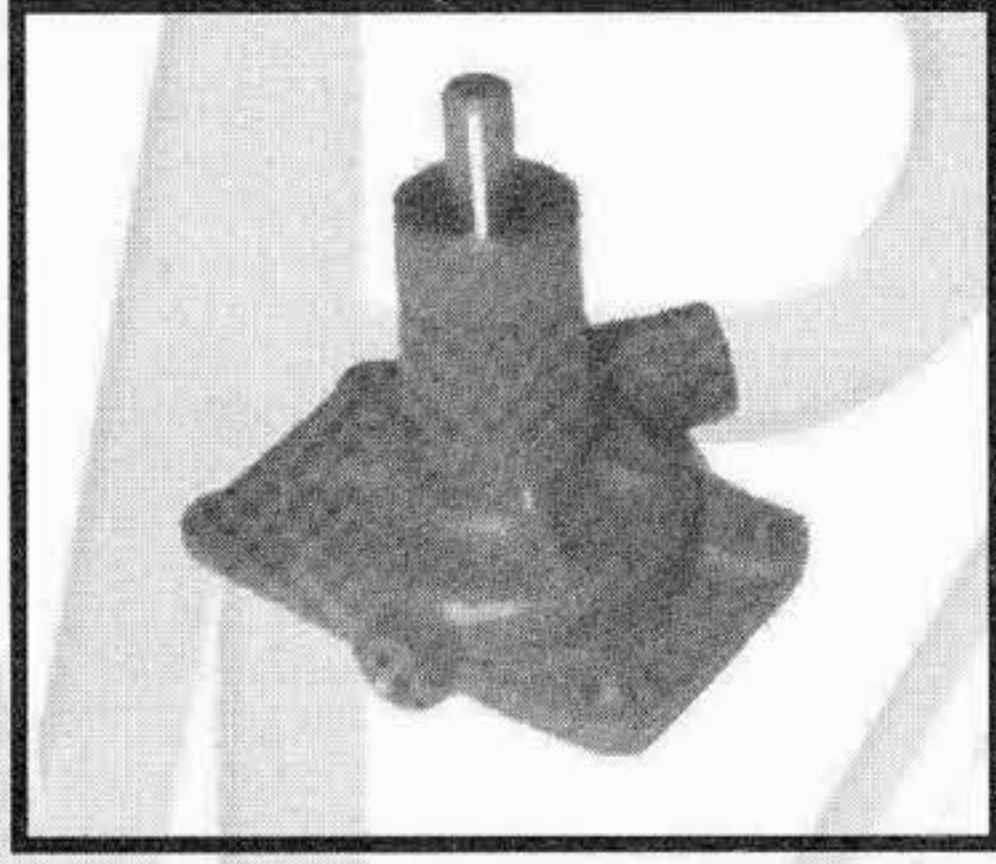
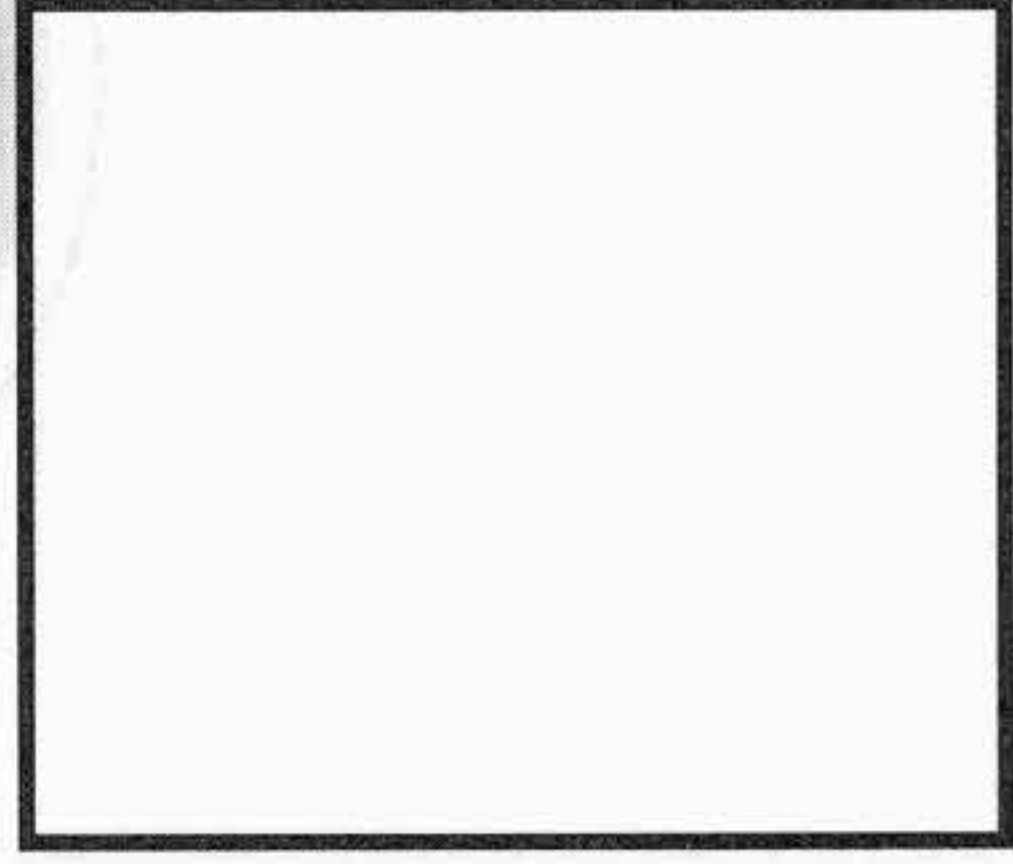
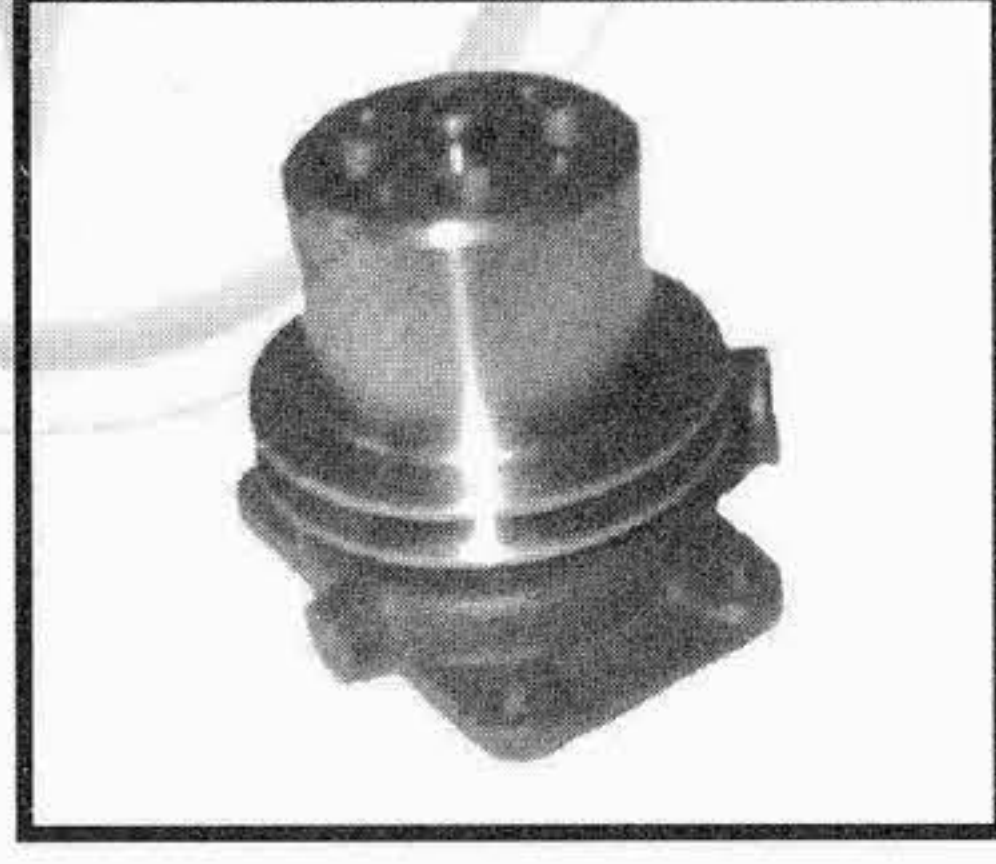
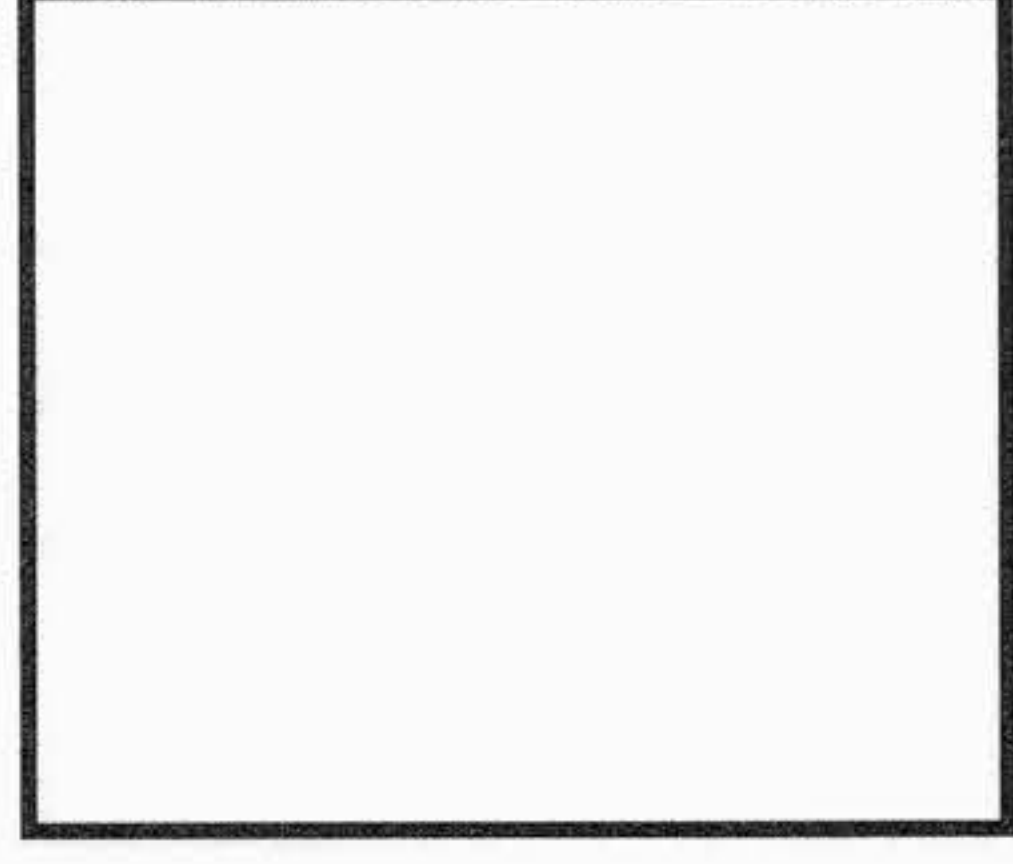
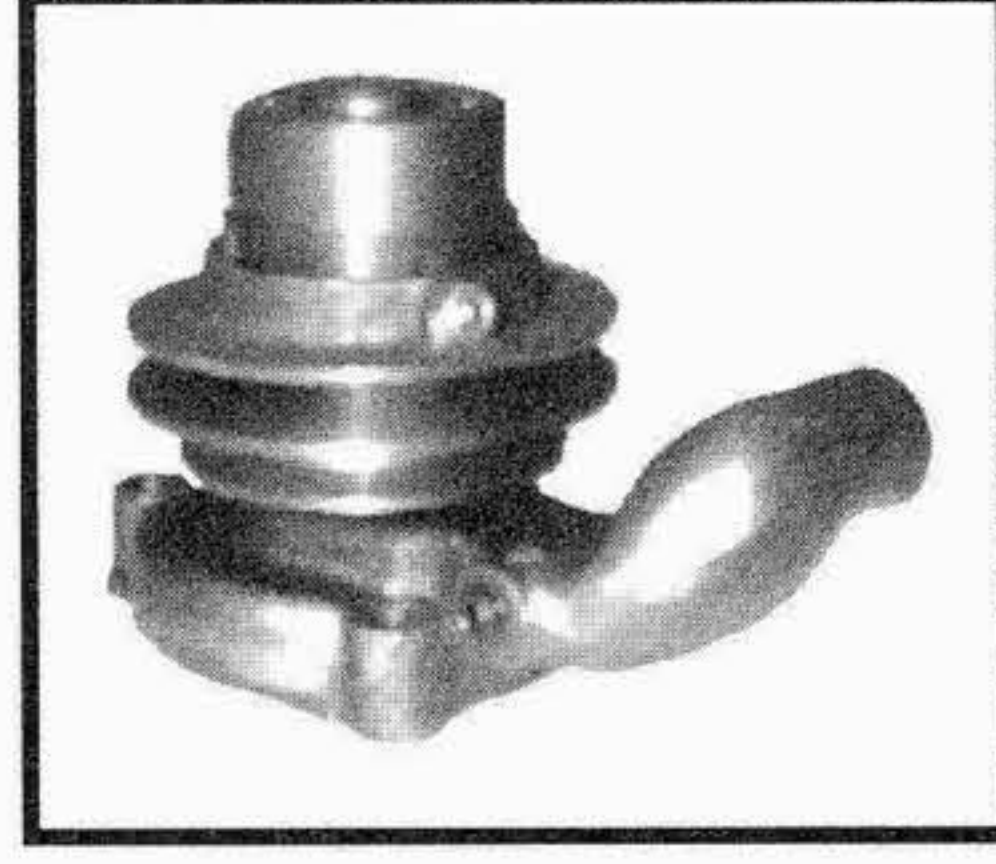
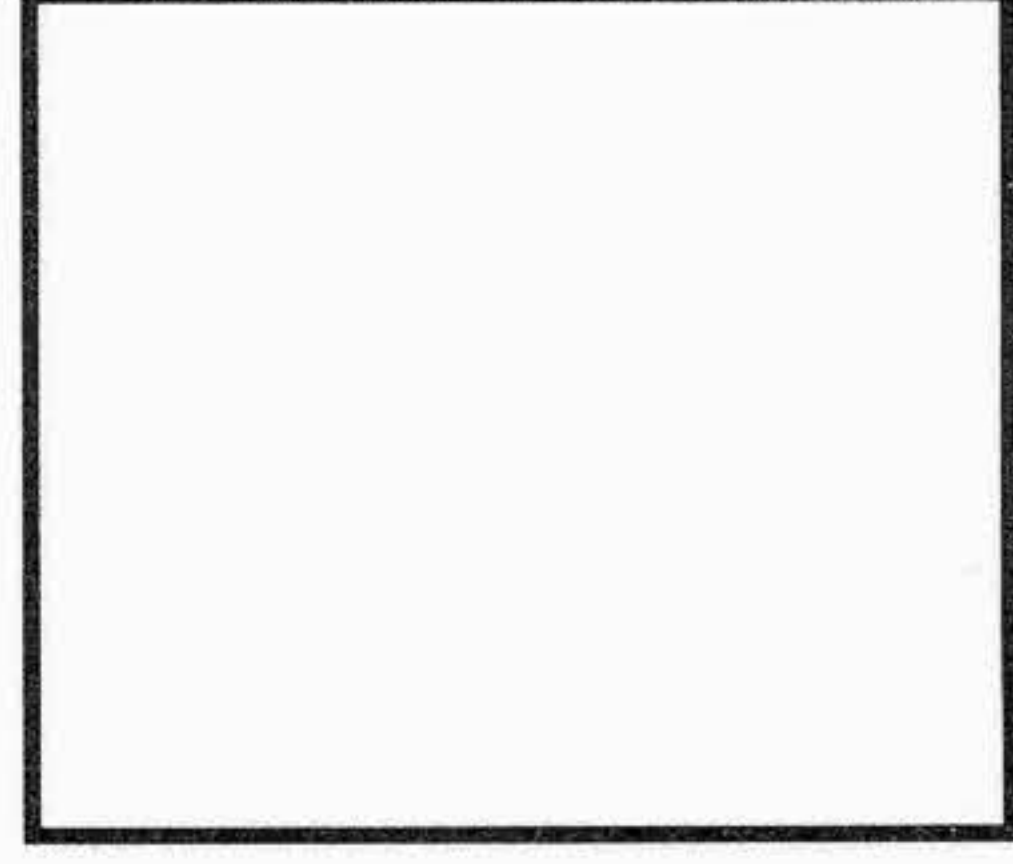

TIPO O MODELLO TYPE OU MODELE TYPE OR MODEL	MOTORE MOTEUR ENGINE	POMPA ACQUA POMPE A EAU WATER PUMP	KIT RIPARAZIONE NECESSAIRE DE REP. REPAIR KIT
DLD 2  DED 3  DGD 4	D 212 - D 214 D 215 - D 217 D 219 - D 320 D 322 - D 324 D 326 - D 430 D 432 - D 436 D 439 - D 440  Engines by Germany	321.020 718891R97  	322.167 3052183R94  
Tractors 137	Serie D  Engines by France	321.030 763613R95  	322.167 3052183R94  
--	Serie D  Engines by Germany	321.056 716410R99  	322.167 3052183R94  
B 250 B 275 B 276 B 354 B 374 B 384 B 414 B 434 B 444	BD 154  con dinamo with dynamo	321.040 3065132R92  	322.165 1094021R91  

I ricambi non sono originali ma adattabili . Ogni riferimento originale é assolutamente indicativo .  
Spare parts are not original but perfectly suitable . Every original part number has to be considered for reference purpose only .

SUITABLE

# CASE IH

Tel: +44(0)1925 850082 Fax: +(0)44 1925 850083

www.spwaterpumps.co.uk

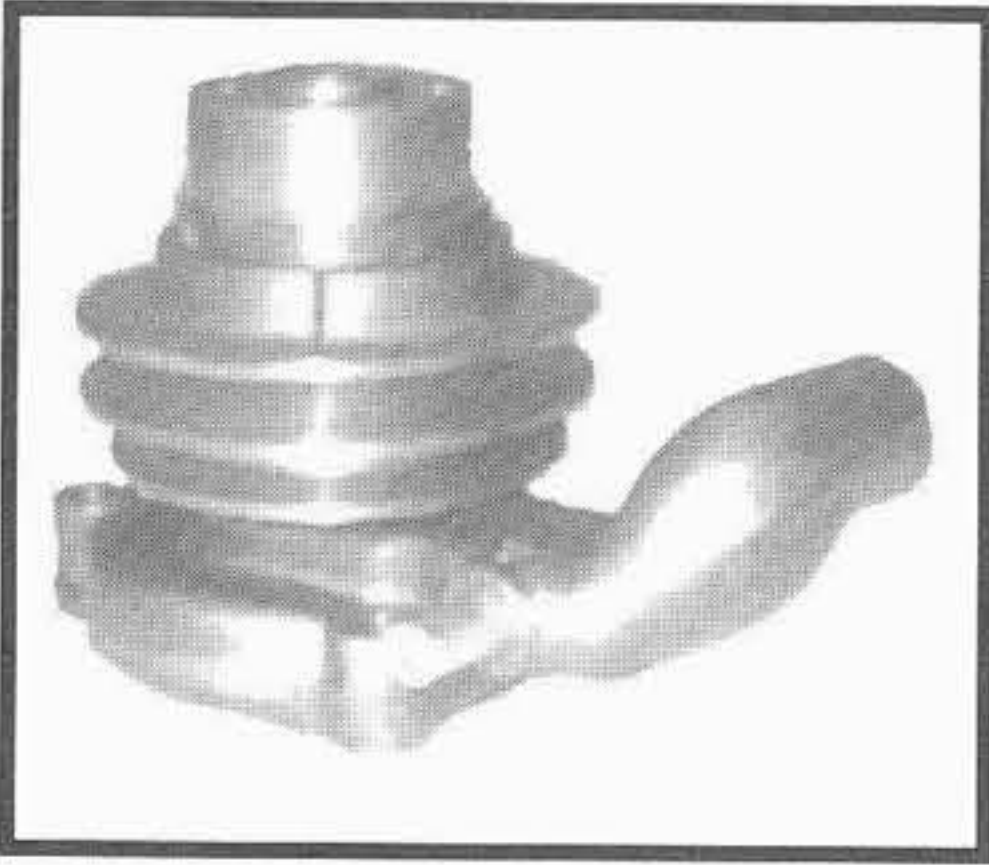
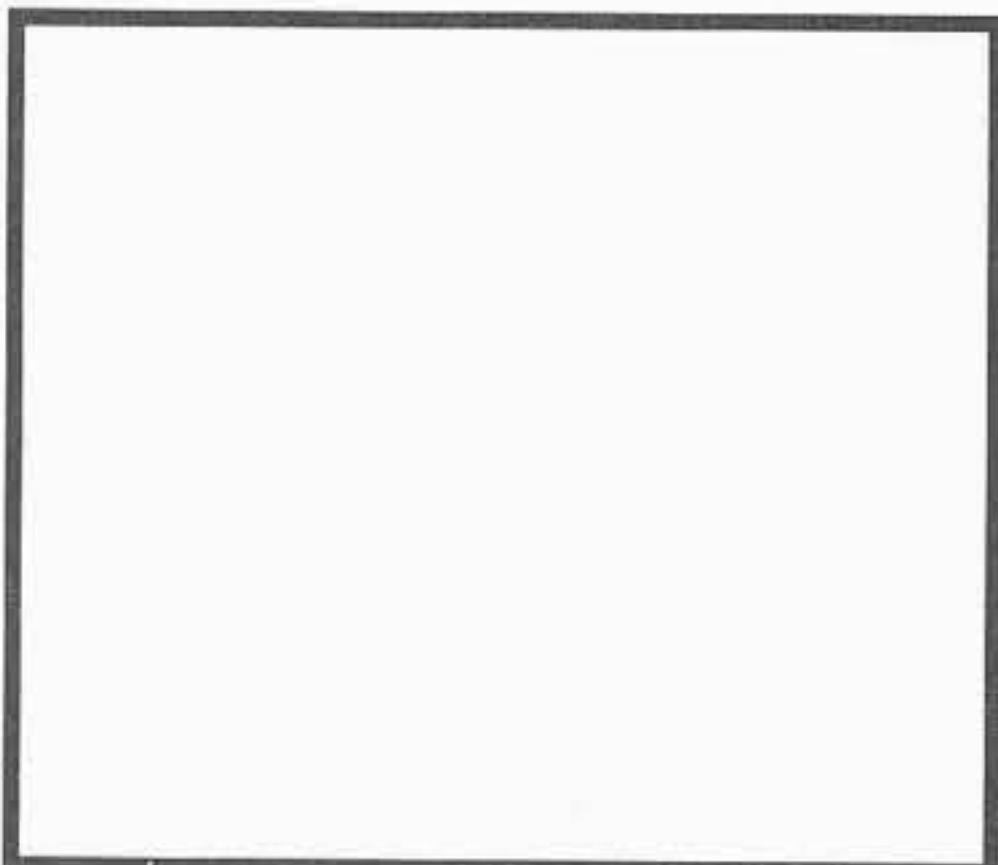
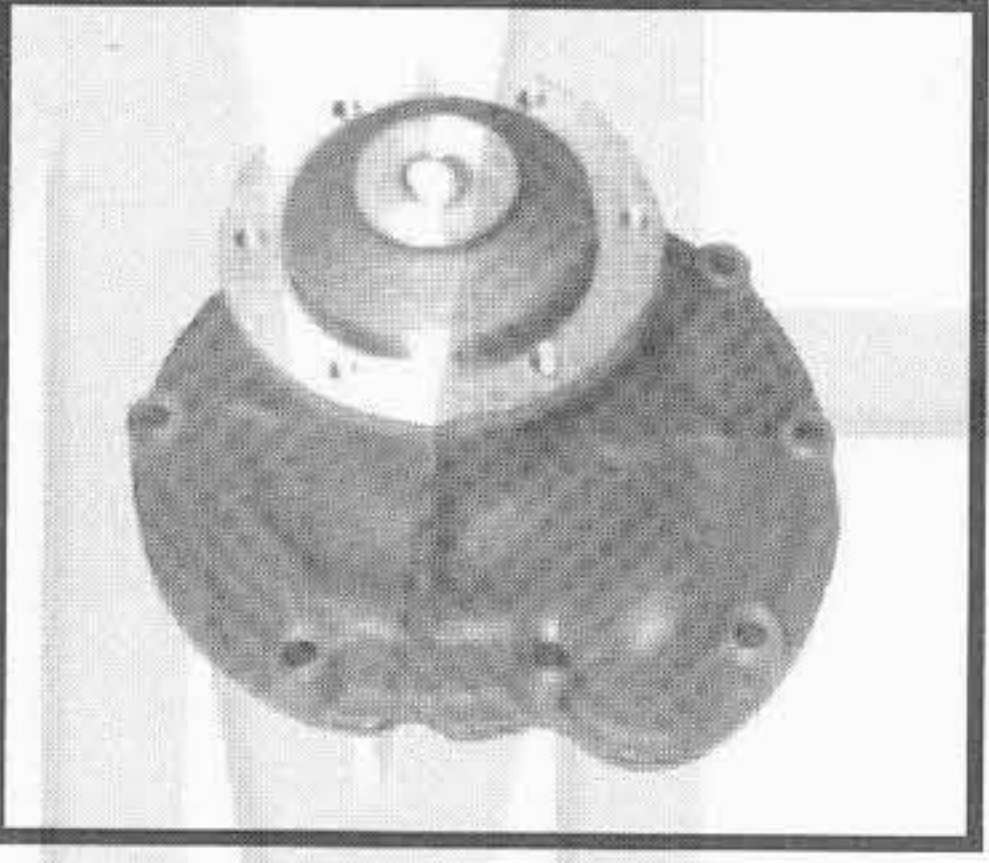
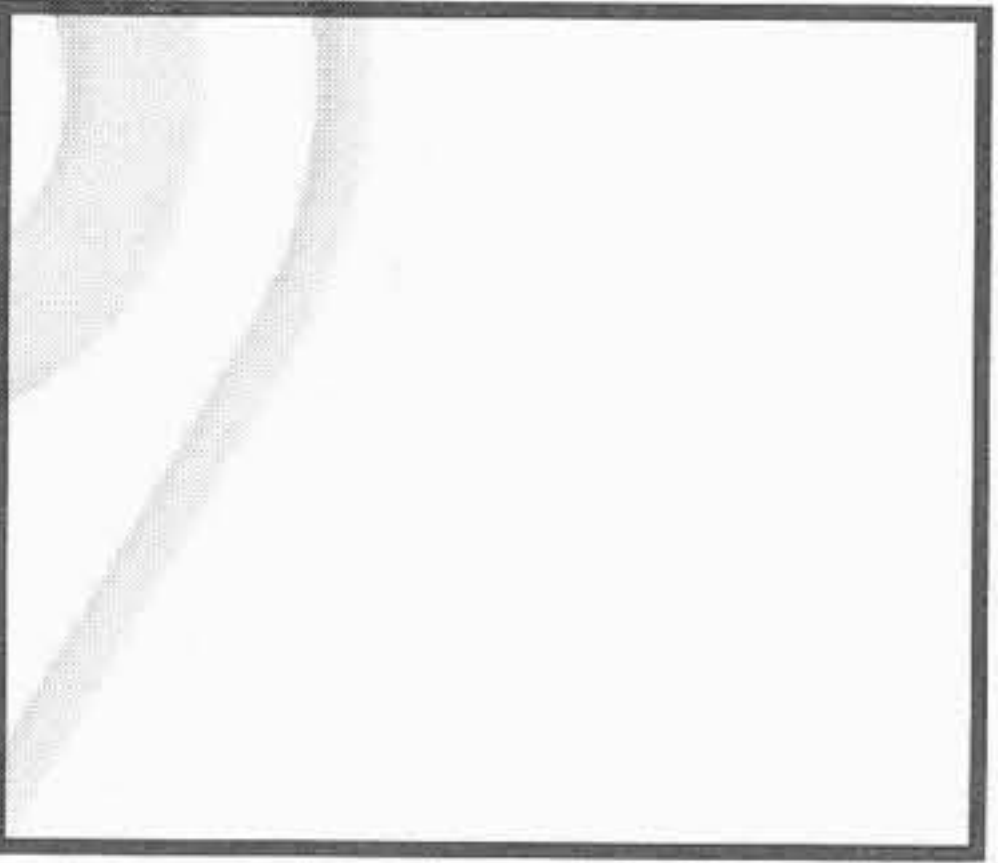
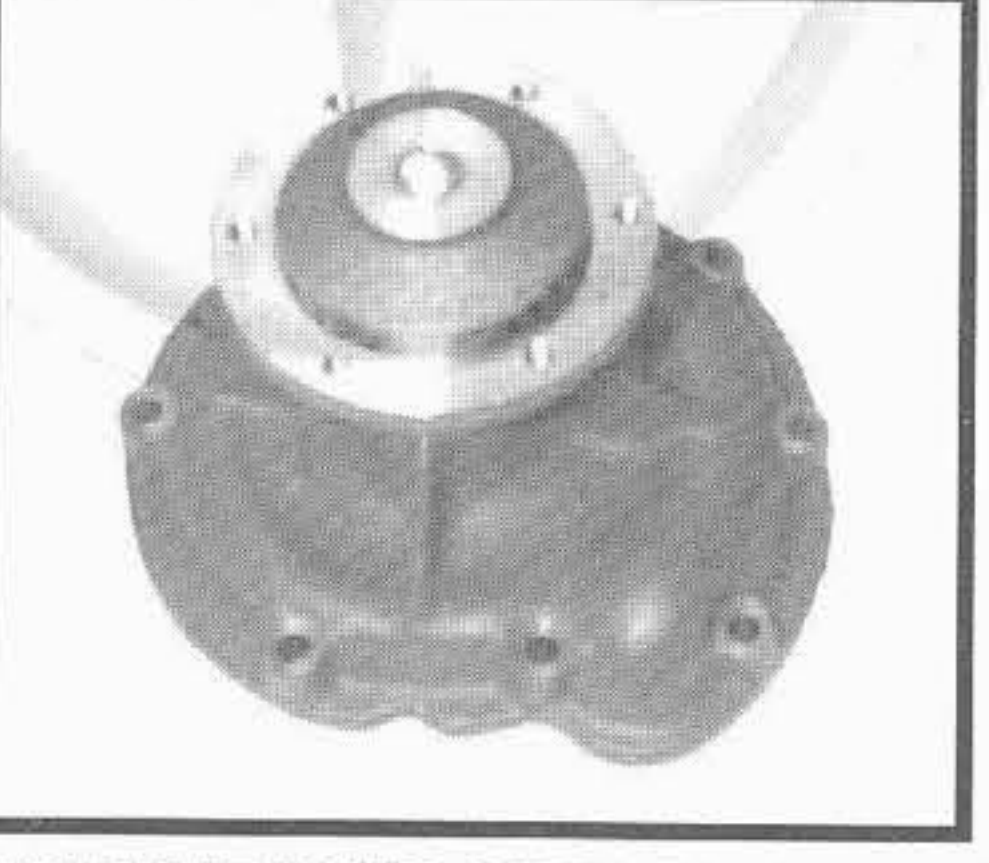
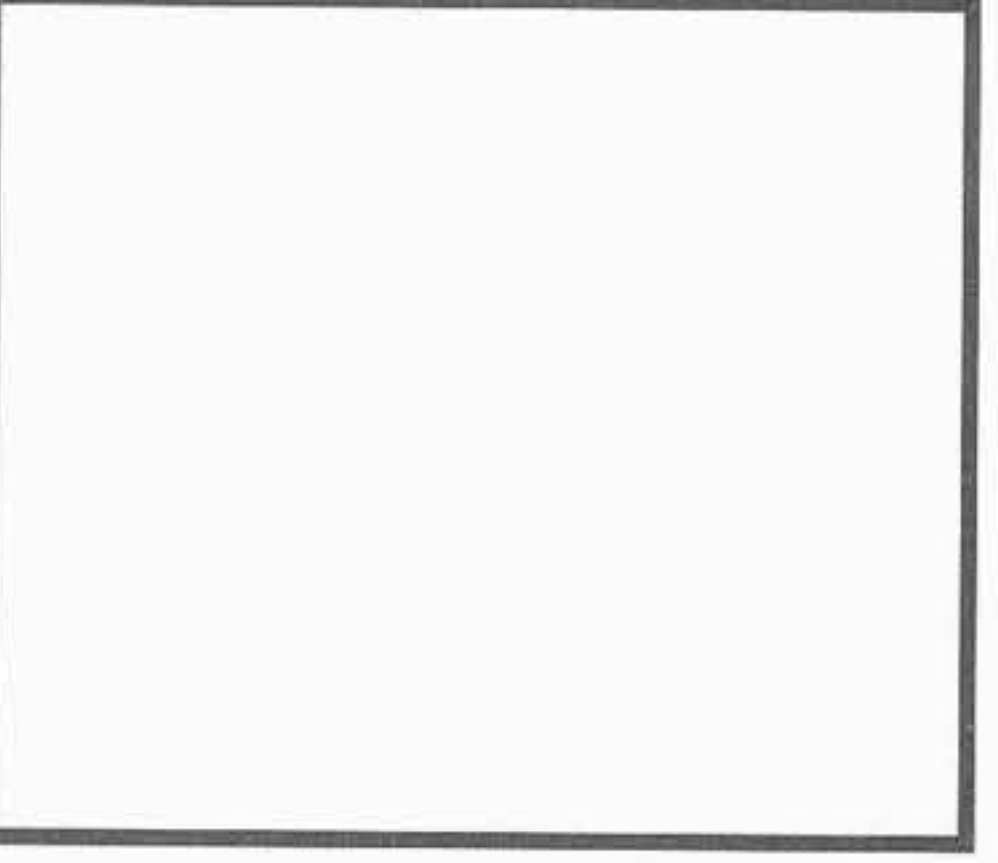
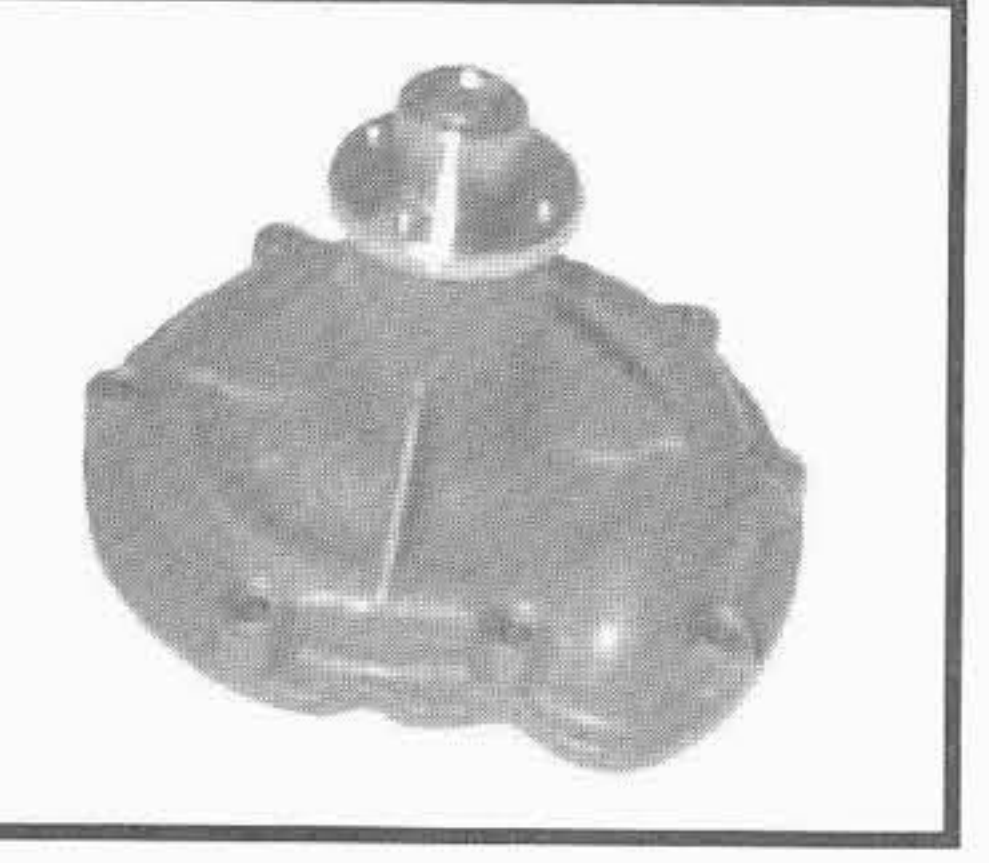
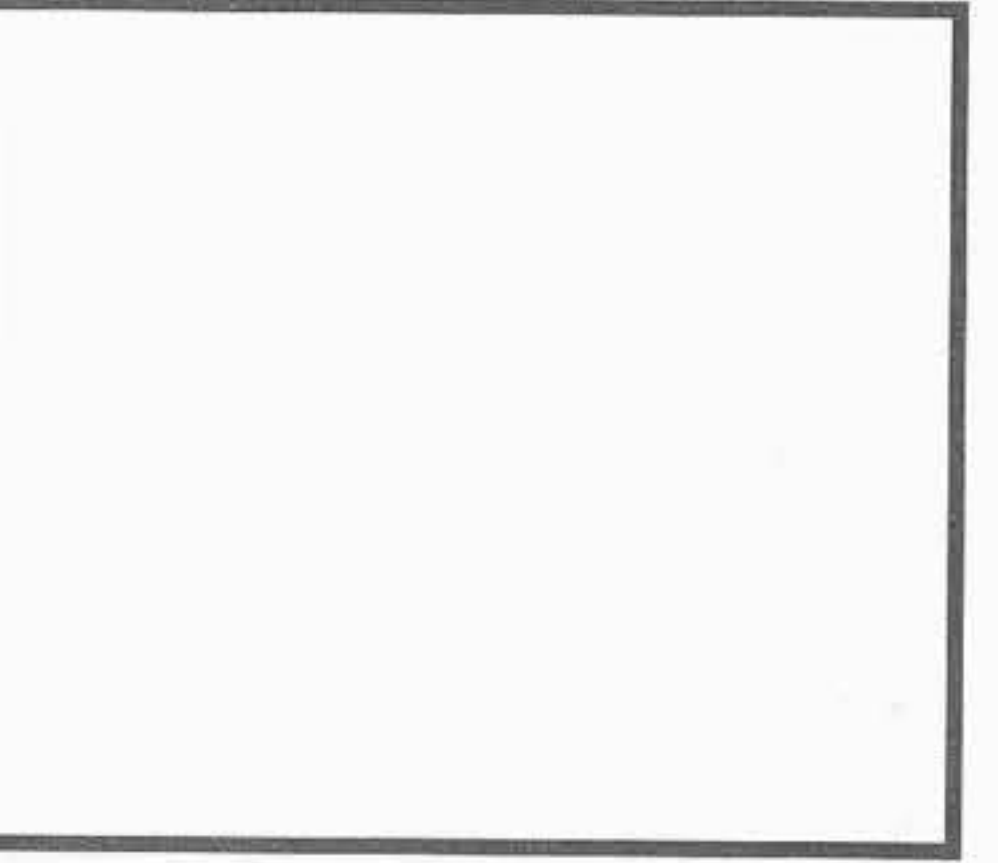

TIPO O MODELLO TYPE OU MODELE TYPE OR MODEL	MOTORE MOTEUR ENGINE	POMPA ACQUA POMPE A EAU WATER PUMP OMP REF. / O.EM. REF	KIT RIPARAZIONE NECESSAIRE DE REP. REPAIR KIT OMP REF. / O.EM. REF
B 414  B 434  B 444	BD 154  con alternatore with alternator	<b>321.050</b> 3119778R92  	<b>322.165</b> 1094021R91  
740 - 840 - 940  433 - 533 - 633 - 733 - 833  743 - 743 XL  554 - 644 - 724 - 744 844 S - 844XL  745 S - 745 XL - 845 845 XL - 985 XL  5000 - 5500 <b>WINDROWER</b>	D 239	<b>321.010</b> 3132738R93   CON GIRANTE / WITH IMPELLER Ø = 98 mm Albero cuscinetto / shaft bearing Ø = 38,1 mm	<b>322.179</b> 1094012R92    <b>322.166</b> 3055285R92
743 - 743 XL  554 - 644 - 744 844 S - 844XL  745 S - 745 XL 845 - 845 XL  856 XL  TD 7 E - TD 8 E  100 E - 125 E	D 239	<b>321.000</b> 3132741R93   CON GIRANTE / WITH IMPELLER Ø = 112 mm Albero cuscinetto / shaft bearing Ø = 38,1 mm	<b>322.178</b> ---    <b>322.166</b> 3055285R92
H 84 N/A - H 85  260 A <b>UK</b>  380 B  474 - 484 - 484 N/A - 584 584 N/A - 684 N/A - 784 N/A  385 - 485 - 585 685 - 785 - 885  395 - 495 - 595 - 695 795 - 895 - 995  248 - 258 - 268 - 288  3210 - 4210 3220 - 4220 3230 - 4230 4240		<b>321.080</b> 3136053R92   CON GIRANTE / WITH IMPELLER Ø = 98 mm Albero cuscinetto / shaft bearing Ø = 38,1 mm	<b>322.179</b> 1094012R92    <b>322.166</b> 3055285R92

I ricambi non sono originali ma adattabili . Ogni riferimento originale é assolutamente indicativo .  
 Spare parts are not original but perfectly suitable . Every original part number has to be considered for reference purpose only .





SUITABLE

# CASE IH

Tel: +44(0)1925 850082 Fax: +(0)44 1925 850083  
www.spwaterpumps.co.uk

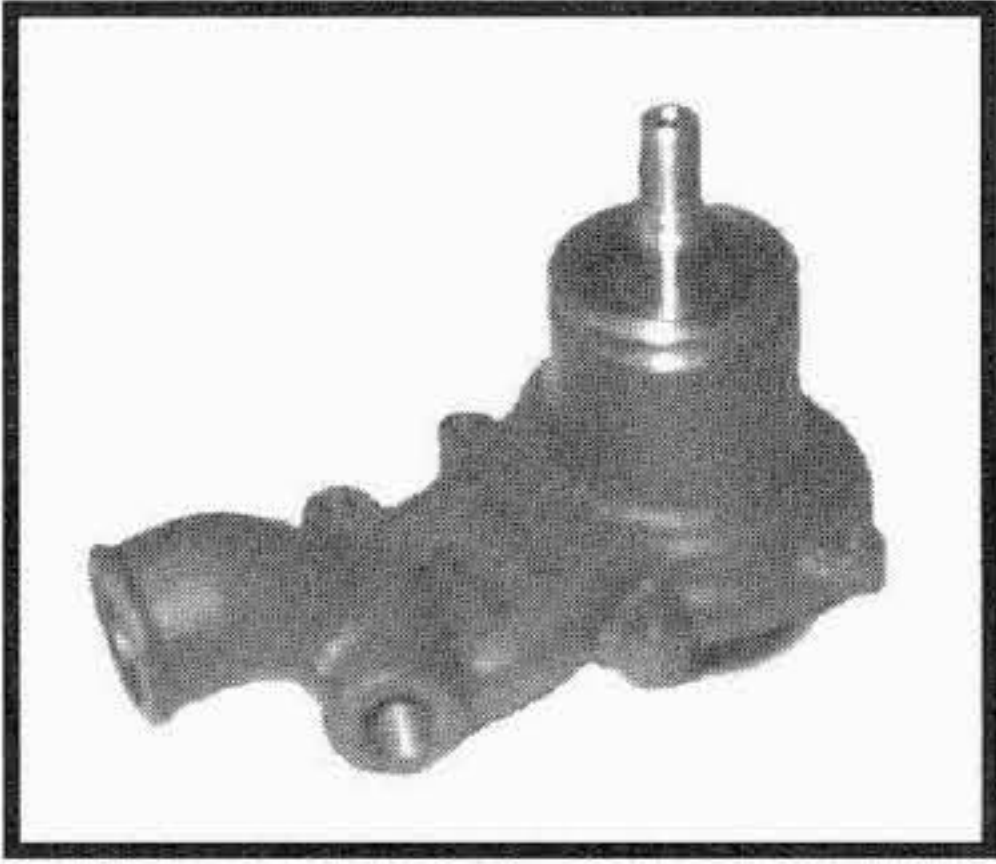

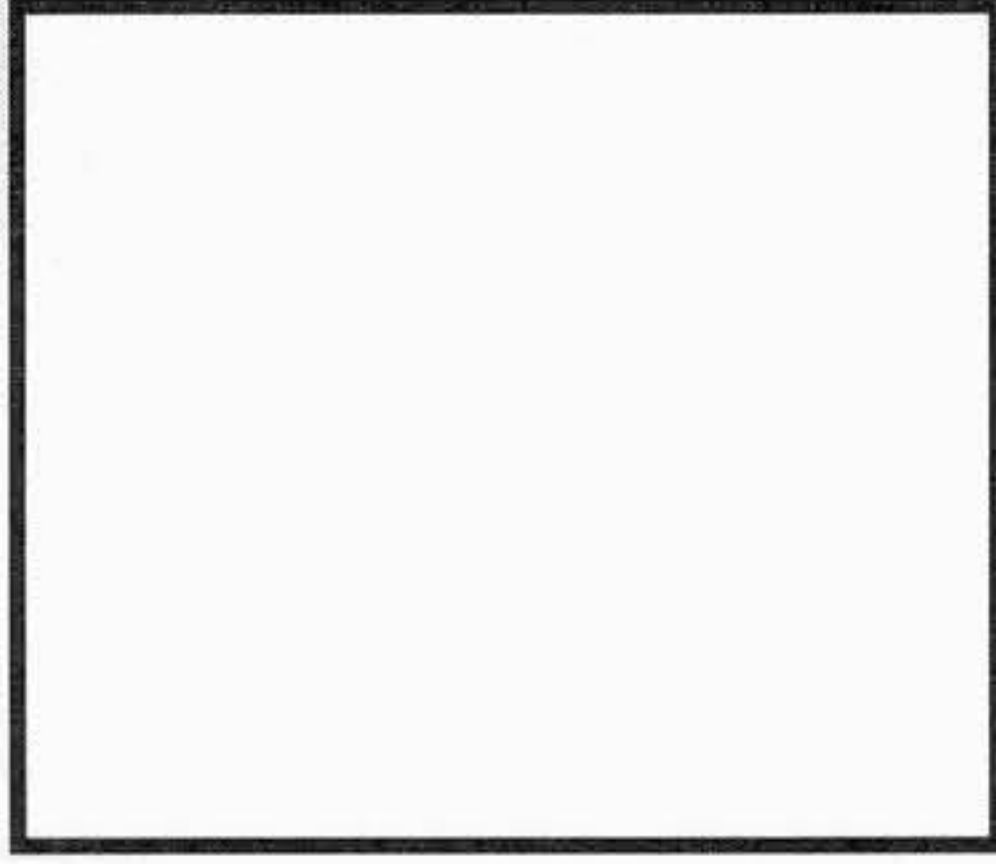
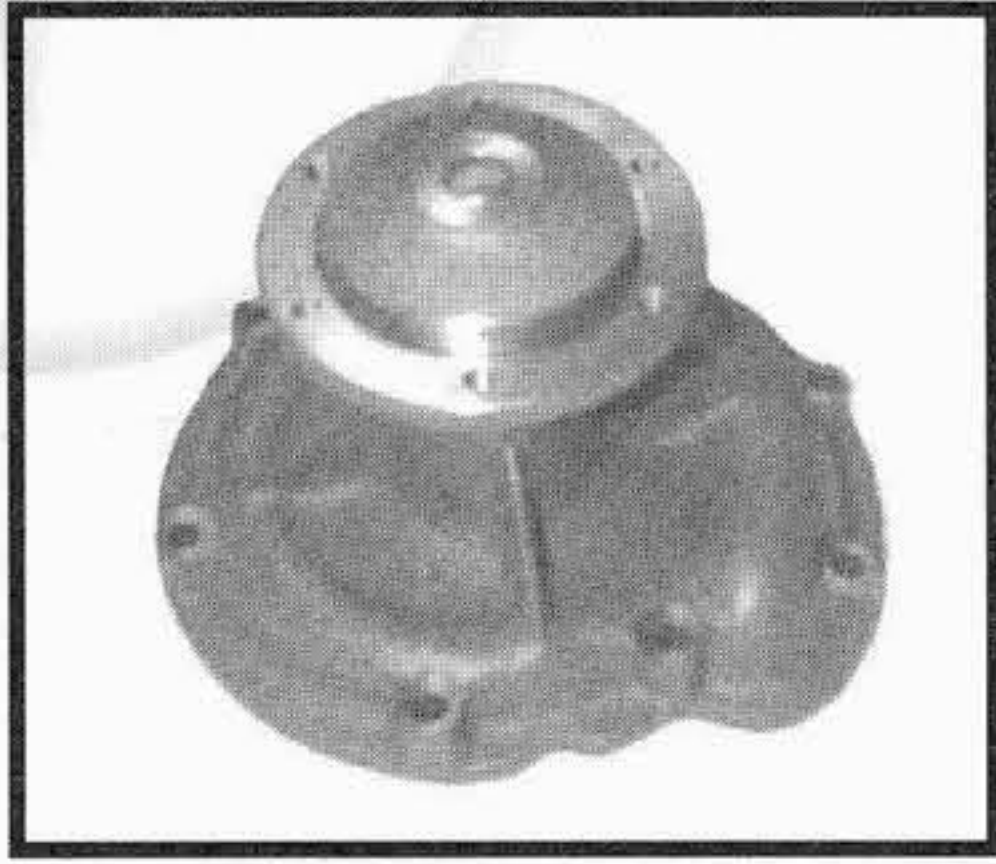
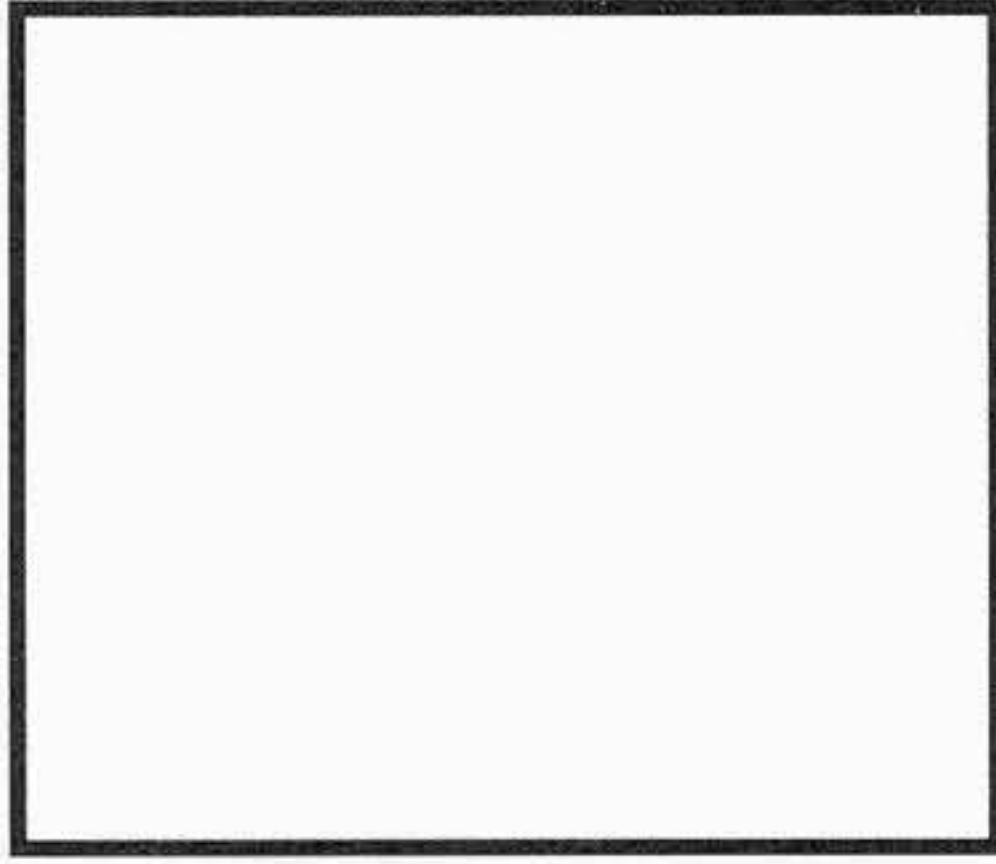
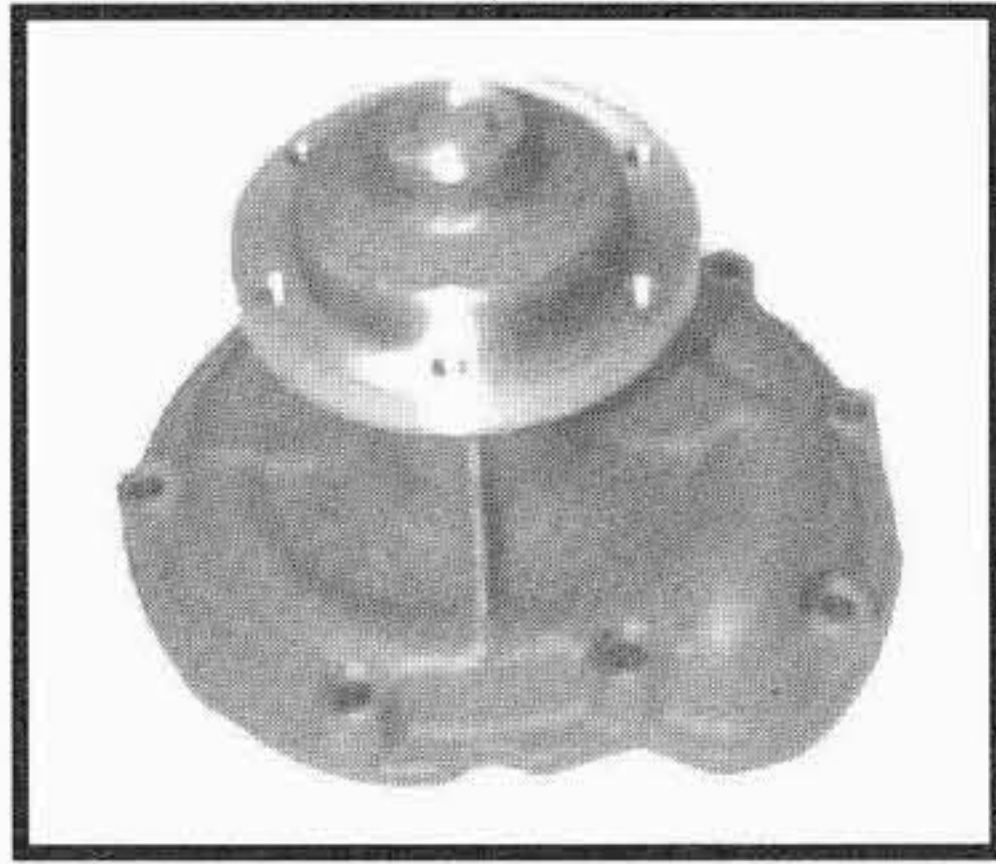
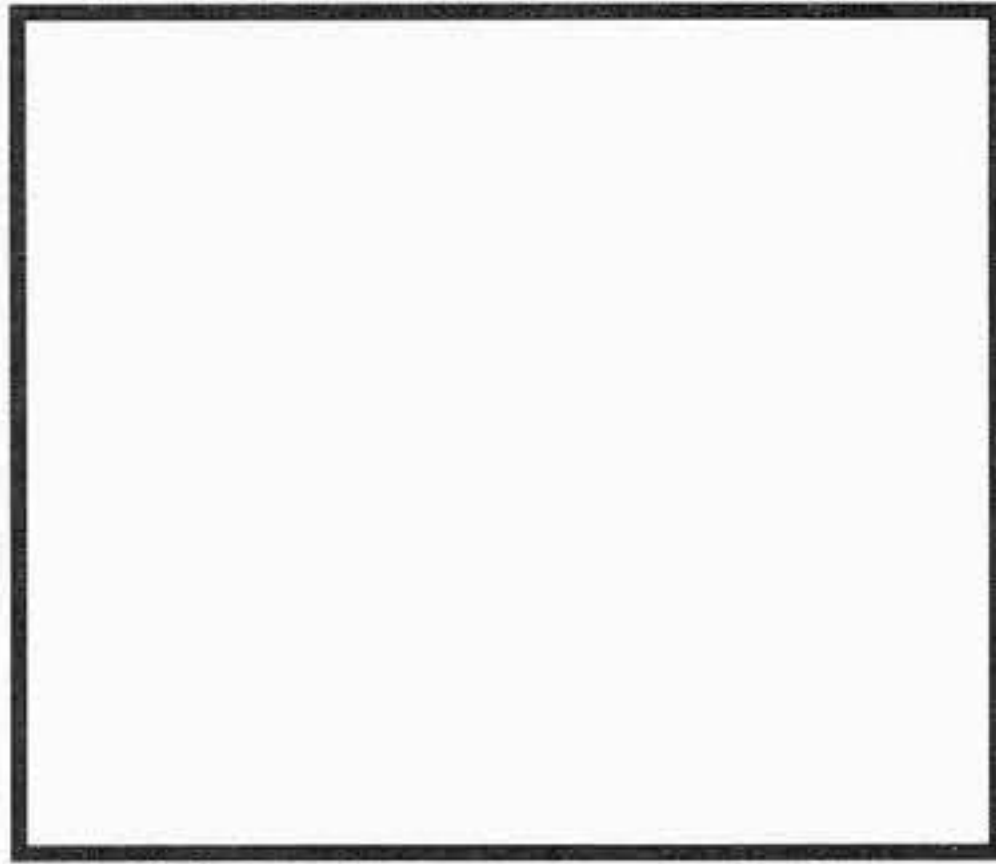
TIPO O MODELLO TYPE OU MODELE TYPE OR MODEL	MOTORE MOTEUR ENGINE	POMPA ACQUA POMPE A EAU WATER PUMP OMP REF. / O.EM. REF	KIT RIPARAZIONE NECESSAIRE DE REP. REPAIR KIT OMP REF. / O.EM. REF
475	A4.236 - A4.248	<b>329.490</b> 3118125R91 	<b>322.183</b> 3118126R91 
H 85  884 N/A  685 - 785 - 885  695 - 795 - 895 - 995  3210 - 4210 3220 - 4220 3230 - 4230 4240		<b>321.090</b> 3132739R93  CON GIRANTE / WITH IMPELLER Ø = 112 mm Albero cuscinetto / shaft bearing Ø = 38,1 mm	<b>322.178</b> ---  <b>322.166</b> 3055285R92
440 - 540 - 640  740 - 840 - 940  433 - 533 - 633 - 733 - 833		<b>321.095</b> 3136217R92  CON GIRANTE / WITH IMPELLER Ø = 98 mm Albero cuscinetto / shaft bearing Ø = 38,1 mm	<b>322.179</b> 1094012R92  <b>322.166</b> 3055285R92
955 XL - 1055 XL - 1255  1255 XL - 1455 - 1455 XL  946 - 1046 - 1246  956 - 956 XL - 1056 - 1056 XL		<b>321.075</b> 3138936R92  CON GIRANTE / WITH IMPELLER Ø = 112 mm Albero cuscinetto / shaft bearing Ø = 38,1 mm	<b>322.178</b> ---  <b>322.166</b> 3055285R92

I ricambi non sono originali ma adattabili . Ogni riferimento originale é assolutamente indicativo .  
Spare parts are not original but perfectly suitable . Every original part number has to be considered for reference purpose only .

SUITABLE

# CASE IH

Tel: +44(0)1925 850082 Fax: +(0)44 1925 850083

www.spwaterpumps.co.uk

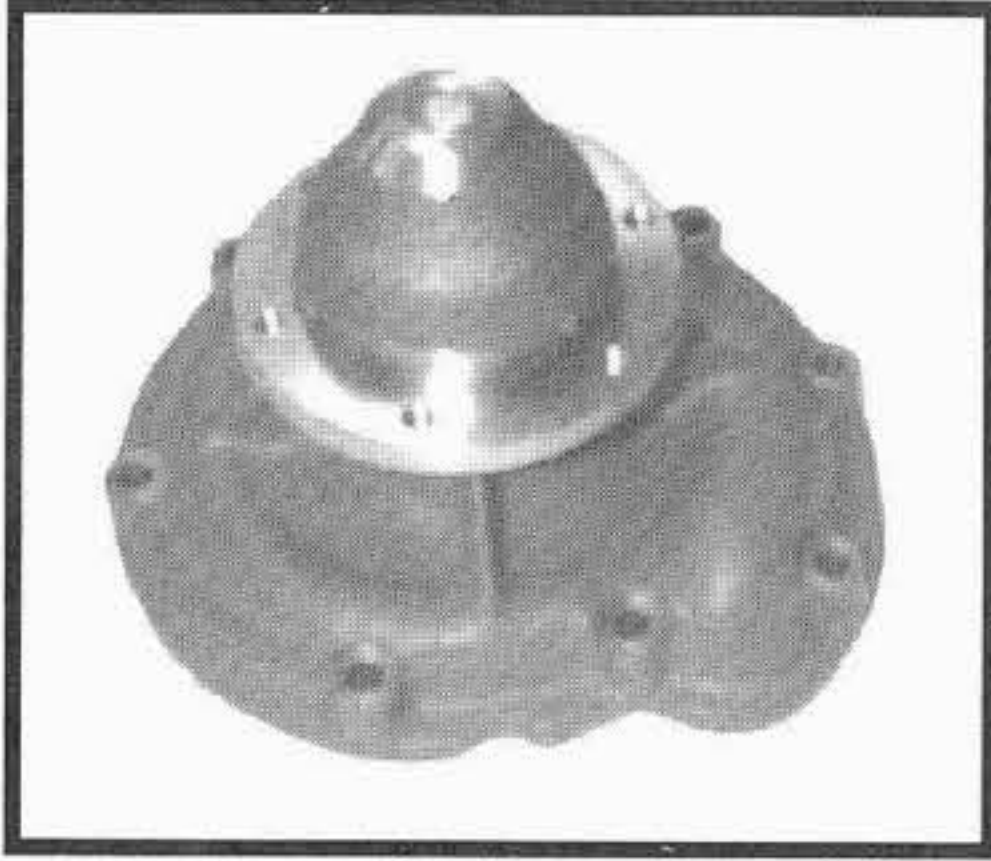
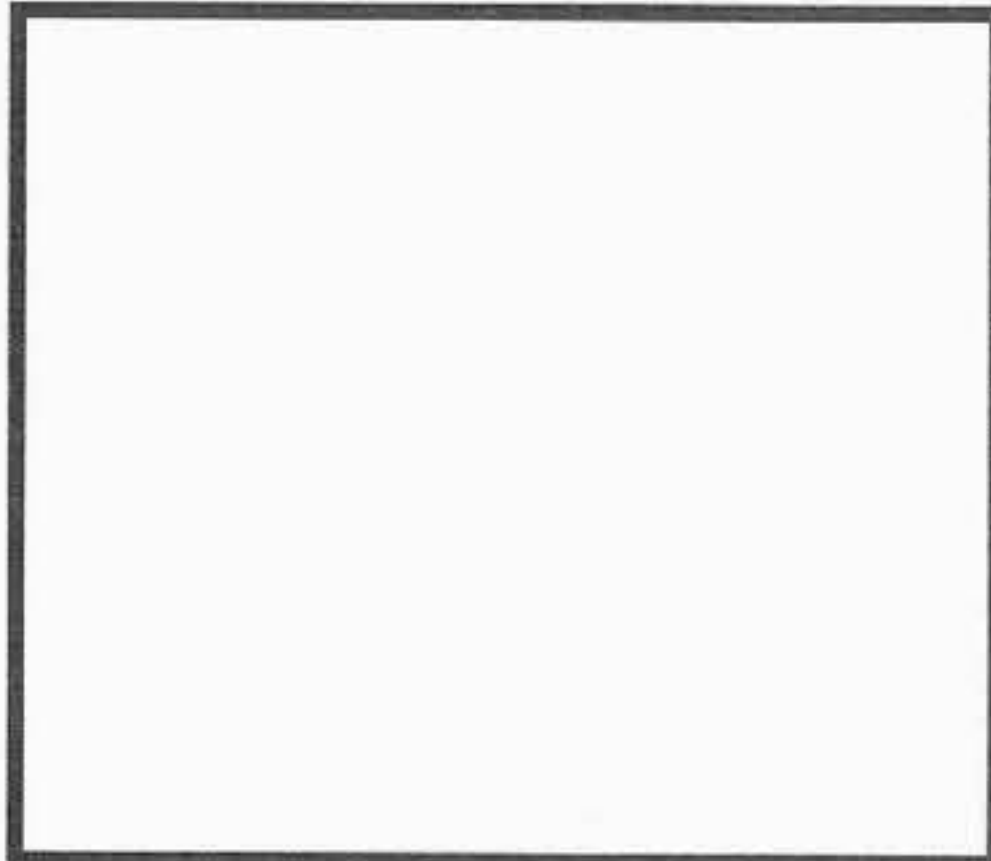
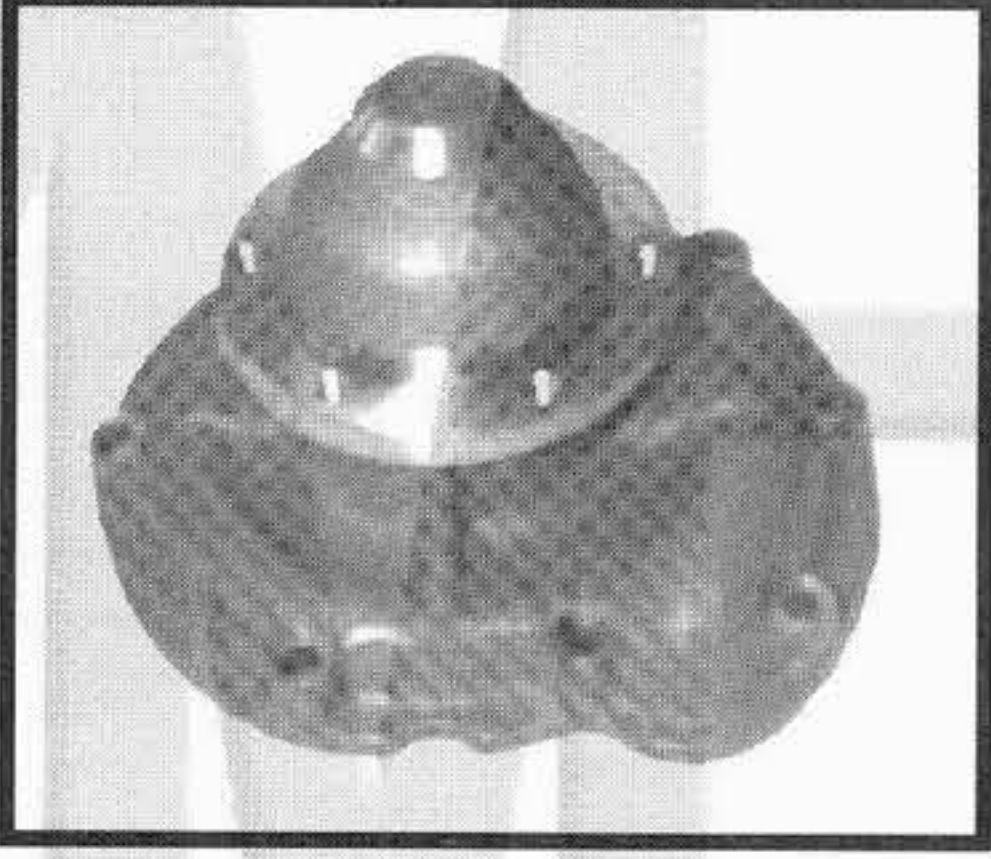
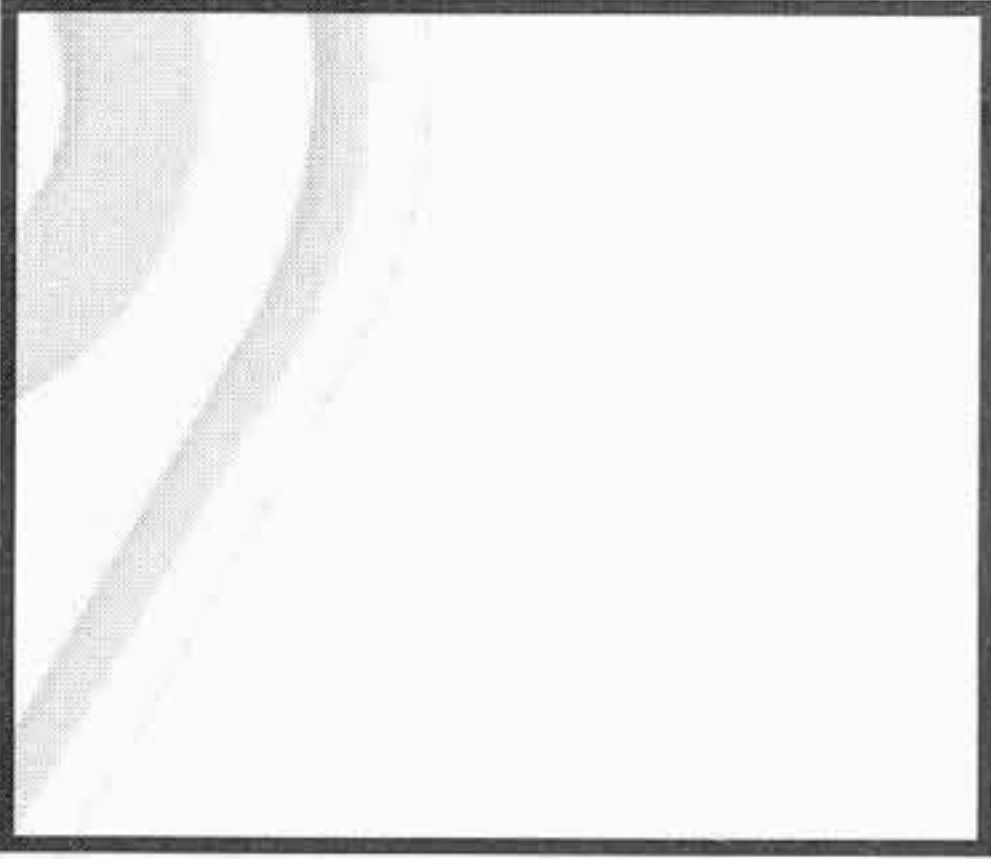
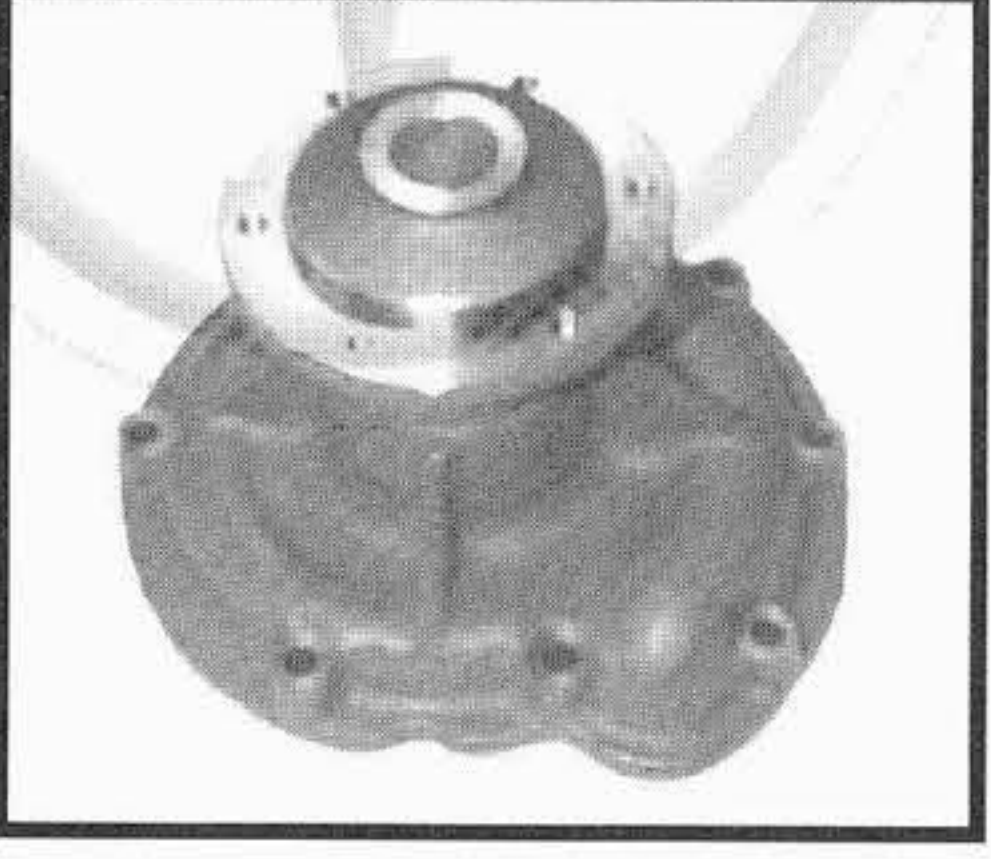
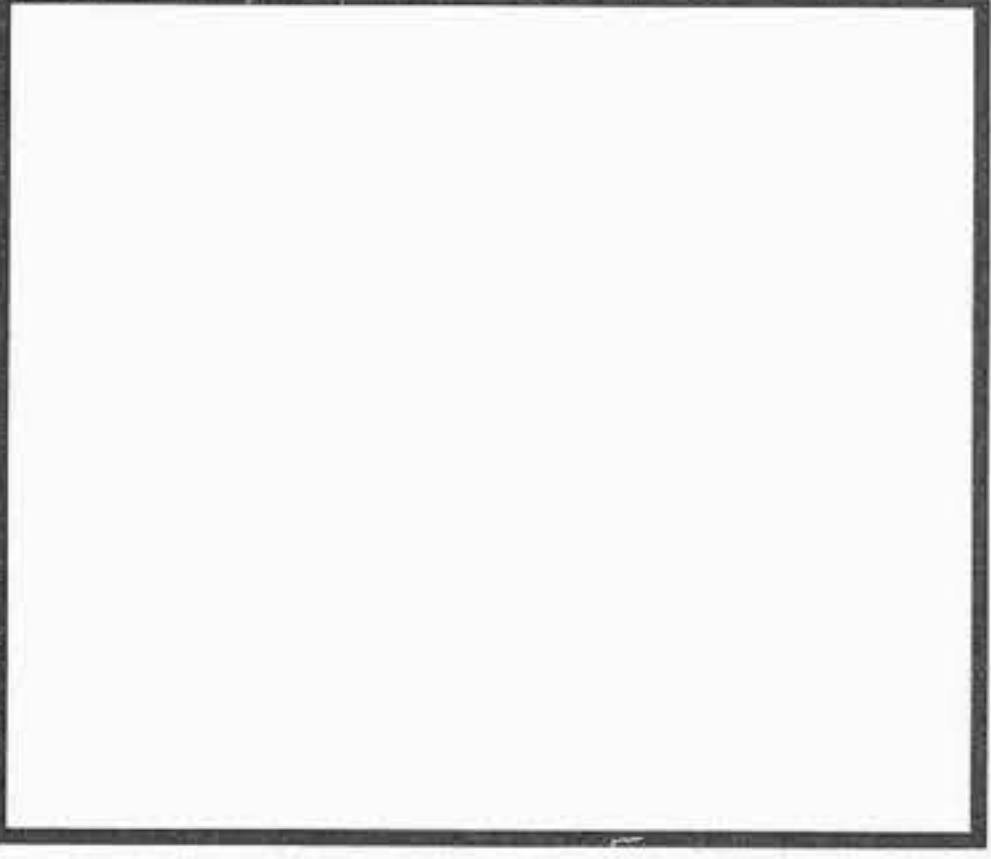
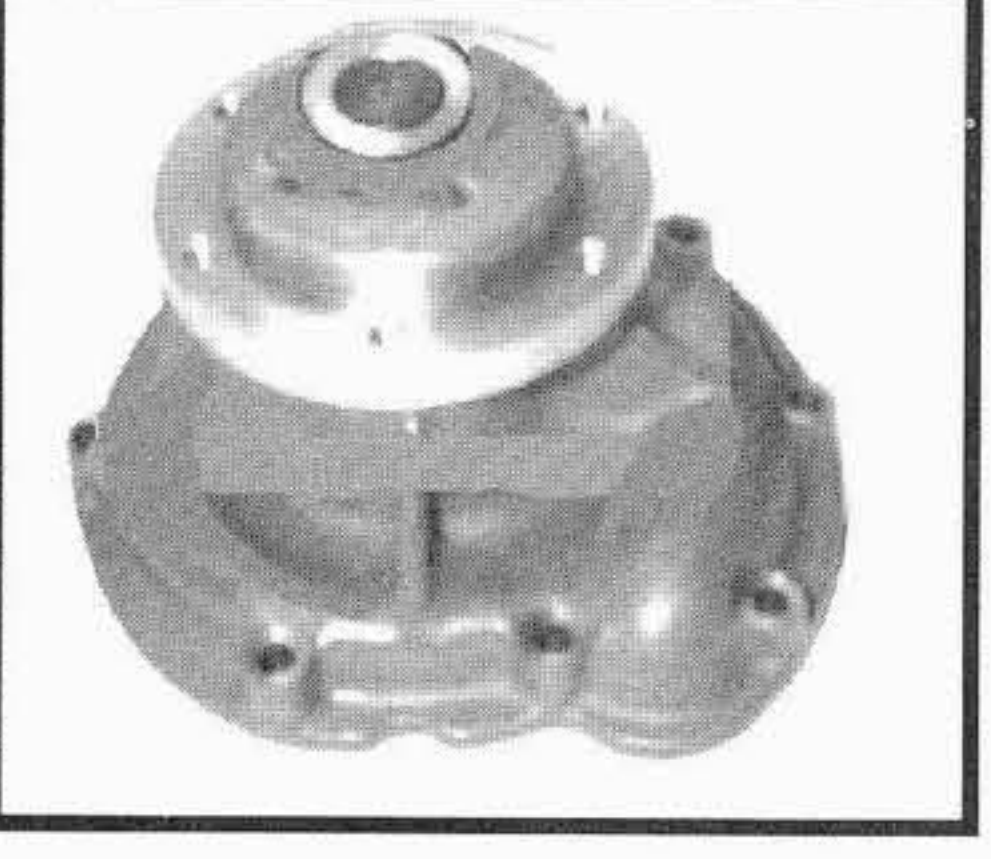
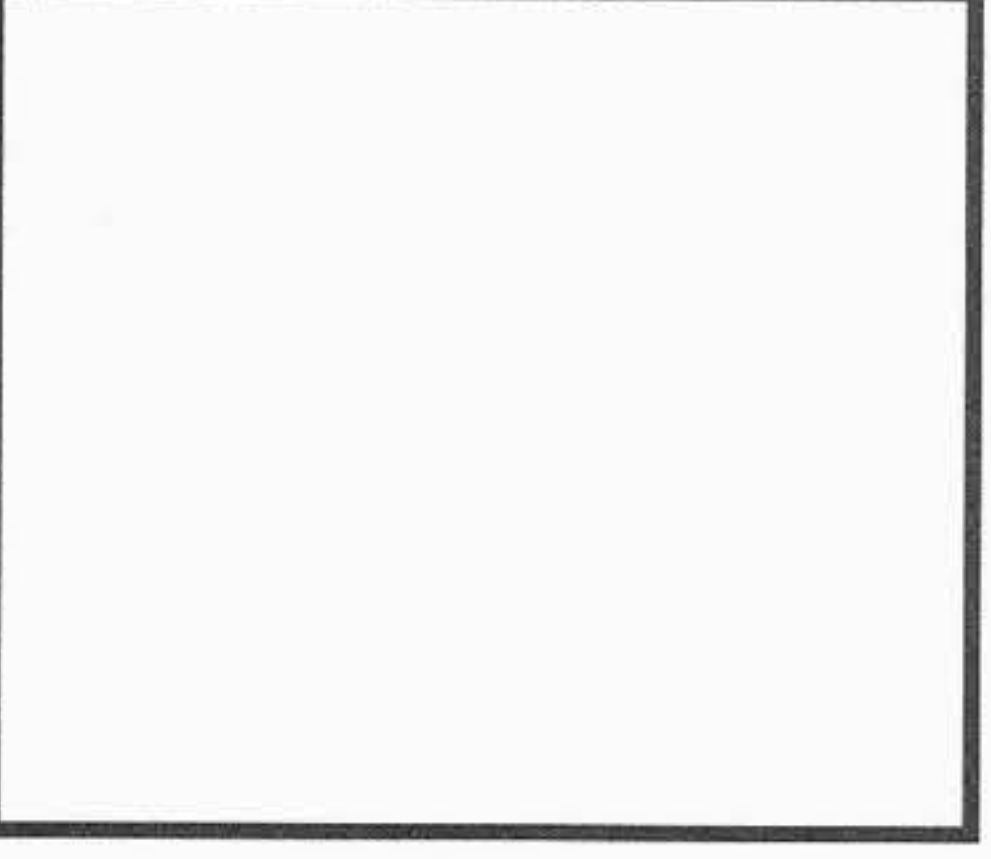

TIPO O MODELLO TYPE OU MODELE TYPE OR MODEL	MOTORE MOTEUR ENGINE	POMPA ACQUA POMPE A EAU WATER PUMP OMP REF. / O.EM. REF	KIT RIPARAZIONE NECESSAIRE DE REP. REPAIR KIT OMP REF. / O.EM. REF
955 XL - 1055 XL - 1255 1255 XL - 1455 - 1455 XL  946 - 1046 - 1246  956 - 956 XL - 1056 - 1056 XL  1620 E	D 358 6 cyl.	<p><b>321.060</b> 3132676R93</p>  <p>CON GIRANTE / WITH IMPELLER Ø = 112 mm                      Albero cuscinetto / shaft bearing Ø = 38,1 mm</p>	<p><b>322.178</b> ---</p>  <p><b>322.166</b> 3055285R92</p>
	DT 358 6 cyl.	<p><b>321.070</b> 3144661R93</p>  <p>CON GIRANTE / WITH IMPELLER Ø = 112 mm                      Albero cuscinetto / shaft bearing Ø = 47 mm</p>	<p><b>322.190</b> ---</p>  <p><b>322.189</b> 3055285R94</p>
510 B	D 268	<p><b>321.085</b> 3144456R93</p>  <p>CON GIRANTE / WITH IMPELLER Ø = 112 mm                      Albero cuscinetto / shaft bearing Ø = 47 mm</p>	<p><b>322.190</b> ---</p>  <p><b>322.189</b> 3055285R94</p>
520 B	D 358	<p><b>321.100</b> 3218038R93</p>  <p>CON GIRANTE / WITH IMPELLER Ø = 112 mm                      Albero cuscinetto / shaft bearing Ø = 47 mm</p>	<p><b>322.190</b> ---</p>  <p><b>322.189</b> 3055285R94</p>

I ricambi non sono originali ma adattabili . Ogni riferimento originale é assolutamente indicativo .  
 Spare parts are not original but perfectly suitable . Every original part number has to be considered for reference purpose only .



SUITABLE

# CASE IH

Tel: +44(0)1925 850082 Fax: +(0)44 1925 850083

www.spwaterpumps.co.uk

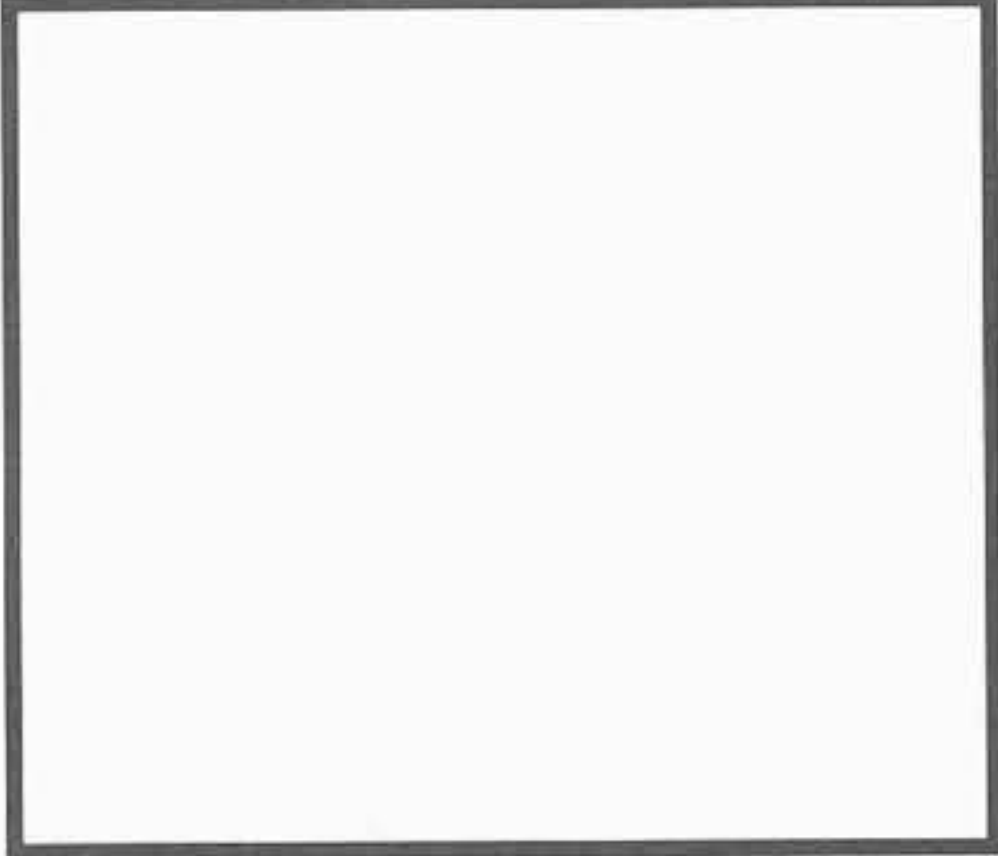
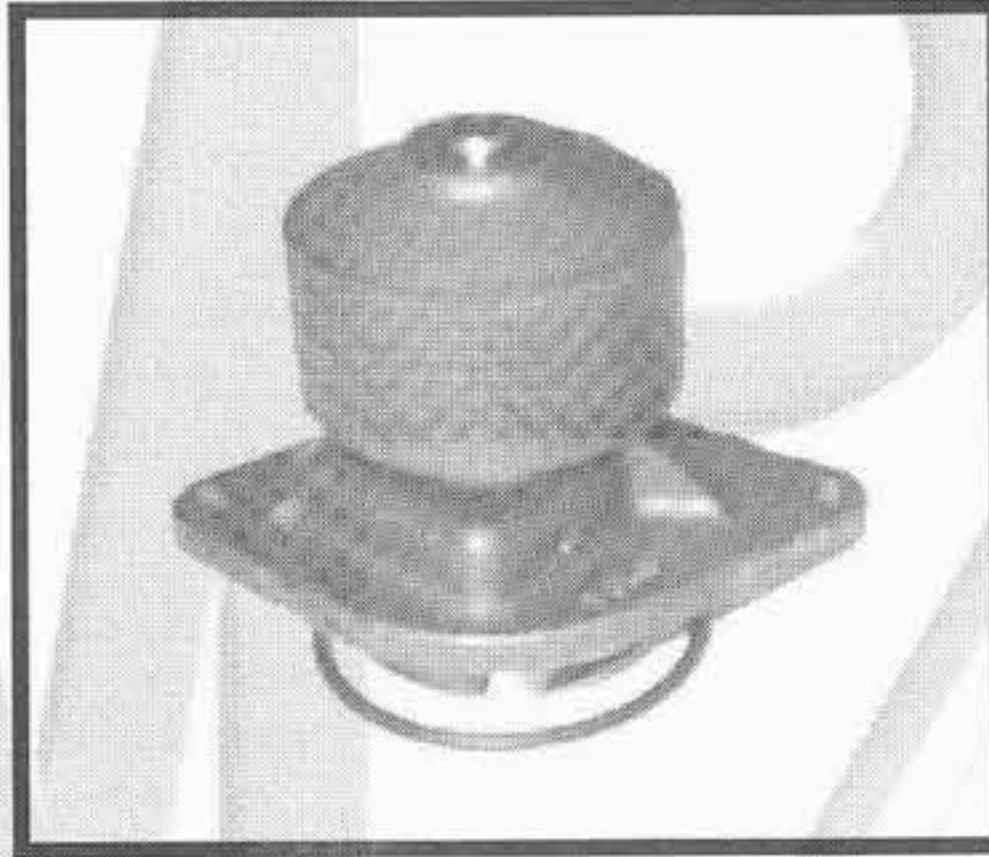

TIPO O MODELLO TYPE OU MODELE TYPE OR MODEL	MOTORE MOTEUR ENGINE	POMPA ACQUA POMPE A EAU WATER PUMP OMP REF. / O.EM. REF	KIT RIPARAZIONE NECESSAIRE DE REP. REPAIR KIT OMP REF. / O.EM. REF
	D 358	<p><b>321.105</b> 3144458R93</p>  <p>CON GIRANTE / WITH IMPELLER Ø = 98 mm Albero cuscinetto / shaft bearing Ø = 47 mm</p>	<p>--- ---</p>  <p><b>322.189</b> 3055285R94</p>
<p>5120 - MX 90 5130 - MX 100 <b>MAXXUM</b> 5140 - MX 120 <b>TRACTORS</b> 5150 - MX 135</p> <p>1840 - 1845 C - 602 752 - 580 K</p> <p>580 K - 688 / C - 688 / P</p> <p>1102 - W 15</p> <p>621 - 888 / C - 888 / P 1088 / C - 1088 / P</p> <p>1640</p>	<p>4 - 390 6 - 590 6T - 590 6TA - 590</p> <p>4 - 390</p> <p>4T - 390</p> <p>6 - 590</p> <p>6T - 590</p> <p>6TA - 590</p>	<p><b>1321.020</b> J802358</p> 	<p><b>NON DISPONIBILE</b> <b>NOT AVAILABLE</b></p>
<p>7110 7120 <b>MAGNUM</b> 7130 <b>TRACTORS</b> 7140</p> <p>1660 - 721</p> <p>1680</p>	<p>6T - 830 6T - 830 6T - 830 6TA - 830</p> <p>6T - 830</p> <p>6TA - 830</p>	<p><b>1321.025</b> J802479</p> 	<p><b>NON DISPONIBILE</b> <b>NOT AVAILABLE</b></p>
<p>966 TRACTOR 815 COMBINE</p> <p>1066 - 1086 TRACTORS 915 COMBINE</p> <p>186 - 1486 - 1586 - 3388 TRACTORS 1460 - 1480 COMBINES</p> <p>4366 - 4386 - 3588 - 3788 TRACTORS 1470 - 1480 COMBINES</p>	<p>D 414</p> <p>DT 414</p> <p>D 436 - DT 436</p> <p>D 436 - DT 436</p>	<p><b>321.110</b> 673162C94</p> 	<p><b>NON DISPONIBILE</b> <b>NOT AVAILABLE</b></p>



**SECTION 09**





**APPLICATION**



**CUMMINS**



**WATER PUMPS WASSERPUMPEN  
POMPE A EAU BOMBA DE AGUA  
POMPA ACQUA**

**S.P. WATER PUMPS LTD**  
18 Tatton Court, Kingsland Grange, Woolston,  
Warrington, Cheshire. ENGLAND. WAI 4RR  
TEL: +44(0) 1925 850082 Fax: +44(0) 1925 850083  
Email:sales@spwaterpumps.co.uk Web Site:www.spwaterpumps.co.uk

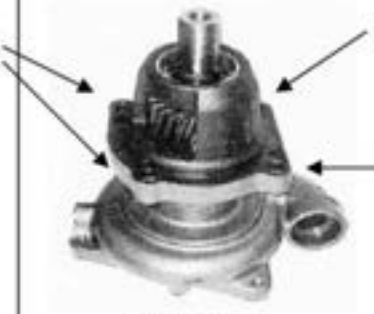

TYPE OR MODEL	ENGINE	WATER PUMP	REPAIR KIT
FFC NTC270-CT NTC290 - NTC290R NT310 NTC350 NTC335 NT855-C280 NT855-310 NT855-C355 NTA855-C360	IMPELLER 5-1/4 inches  Twin Groove Pulley	<p style="text-align: center;"><b>451.040</b></p>  <p style="text-align: center;">AR45090—3000886</p>	
		<p style="text-align: center;"><b>451.045</b></p>  <p style="text-align: center;">AR45182—3022475</p>	
BIG CAM  NTC290 NTC350 NTC400  FORMULA 290 FORMULA 350	IMPELLER 4-1/2 inches  MULTI VEE PULLEY Diameter 4-11/16 inches	<p style="text-align: center;"><b>451.050</b></p>  <p style="text-align: center;">C3022474—AR45184</p>	
		<p style="text-align: center;"><b>451.055</b></p>  <p style="text-align: center;">3801788</p>	

TYPE OR MODEL	ENGINE	WATER PUMP	REPAIR KIT
<b>B SERIES</b>  4CYL - 3900 cc 4B 3.9, 4BT 3.9, 4BTA 3.9  6 CYL - 5900 cc 6B 5.9, 6BT 5.9 6BTA 5.9	6 Ltr B SERIES  ERF EC6 Daf 44, 55 Dennis Dart	<b>451.020</b>    3927105	
<b>C SERIES</b>  6 CYL - 8300 cc 6CT8 - 6CTA 8.3	8 Ltr C SERIES  ERF EC8  Dennis Javelin	<b>451.025</b>    3913430	
<b>ISB ENGINE</b>  6 CYL - 6 Ltr  Fitted With 7 Vane High Output Impeller	<b>ISB ENGINE</b>  Iveco Tector Daf LF45, LF55  Late Version Dennis Dart Fitted with ISB	<b>451.021</b>	
<b>ISC ENGINE</b>  6 CYL - 8 Ltr	<b>ISC ENGINE</b>	<b>451.026</b>	

TYPE OR MODEL	ENGINE	WATER PUMP	REPAIR KIT
<b>CUMMINS L10</b> 10 Ltr Engine ERF EC10 LTA10-240, 270, 300	L10 ENGINE 4 Hole Mounting Before 1991 3803402 3801840	<b>ZSP1233</b>  C3801524	
<b>CUMMINS M11</b> 11 Ltr Engine C3803404 ERF EC11 L10-310E L10-330E MTA11-330E Used on a 2 Belt System	LONG SHAFT 65 mm 3 Hole Mounting 1991 & After 3803403	<b>ZSP1234</b>  C3800737	
<b>CUMMINS M11</b> 11 Ltr Engine SHORT SHAFT VERSION - 30 mm C3800754 Late Version ERF EC11 ECX11	SHORT SHAFT 30 mm 3 Hole Mounting	<b>ZSP1235</b>  C3800754	





## **SECTION 14**

# **APPLICATION**

# **EBRO**

**WATER PUMPS WASSERPUMPEN**  
**POMPE A EAU BOMBA DE AGUA**  
**POMPA ACQUA**

**S.P. WATER PUMPS LTD**  
18 Tatton Court, Kingsland Grange, Woolston,  
Warrington, Cheshire. ENGLAND. WAI 4RR  
TEL: +44(0) 1925 850082 Fax: +44(0) 1925 850083  
Email:sales@spwaterpumps.co.uk Web Site:www.spwaterpumps.co.uk

TAVOLE DI CONVERSIONE  
TABLE DE CONVERSION  
CONVERSION TABLE

EBRO









NUMERO ORIGINALE NUMERO ORIGINAL ORIGINAL NUMBER	NUMERO SOSTITUTIVO REPLACE PAR NUMERO REPLACED BY NUMBER	RIFERIMENTO OMP REFERENCE OMP OMP REFERENCE
32346		259.066
58293	89019	252.168
58307		152.152
58719	58307	252.152
59140	89024	252.192
85800	U7LW0025	
86957	U7LW0029	
89019	U7LW0044	252.130
89024	U7LW0027	252.107
89034	U7LW0006	252.094
0030927		259.058
0040057		259.008
0170040		251.184
0170046		259.009
0330875		259.112
0380098		259.053
0380164		259.051
0490484		259.068
0490690		259.064
0500006		251.191
0524406		259.028
0572226		259.102
0576005		259.006
0650540		259.041
0748419		259.071
0920007		259.007
0920009		259.032
0920056		259.037
0920058		251.772
0920106		251.381
2232133		259.072
2415209	2415216	
2415216		251.042
2417208		259.022
2431154		259.041
2564406		259.028
2418M001	2418M004	259.428
2418M004		259.428
2521D406		259.158
31145741		259.085
31146952		259.015
32753417		259.056
32764119	3276P003	
32764127	3276P003	
3276P003		259.014
3312K011		259.156
33143112		259.024

NUMERO ORIGINALE NUMERO ORIGINAL ORIGINAL NUMBER	NUMERO SOSTITUTIVO REPLACE PAR NUMERO REPLACED BY NUMBER	RIFERIMENTO OMP REFERENCE OMP OMP REFERENCE
33157108		259.019
33157109		259.017
33415117		253.169
33811314		259.052
33813313		259.018
33814115		259.038
36866271		259.042
36866724		259.374
36866729		259.369
36867128		259.367
36867137		259.366
36867138		259.368
36867157		259.047
36867198		259.371
37447192		259.061
37447603		259.076
37477232		259.059
37711262		259.063
37711301		259.104
37711530		259.067
37711632		259.016
41312207	41312518	
41312416	41312487	
41312487		259.080
41312511	41312574	
41312518		259.110
41312574		259.040
41313201	41313225	
41313225	41313231	
41313231	4131A013	
41313231P		259.450
41313232	4131A021	
4131A013	4131A021	
4131A021		159.490
U5MW0010	U5MW0055	
U5MW0019		159.110
U5MW0023		159.310
U5MW0055	U5MW0061	
U5MW0061		159.365
U7 LW0025		152.112
U7 LW0027		152.107
U7 LW0029	U7LW0032	
U7 LW0032		152.183
U7 LW0044		152.130

OGNI RIFERIMENTO ORIGINALE E' ASSOLUTAMENTE INDICATIVO. CHAQUE REFERENCE ORIGINAL EST ABSOLUMENT INDICATIVE. EVERY ORIGINAL PART NUMBER HAS TO BE CONSIDERED FOR REFERENCE PURPOSE ONLY.

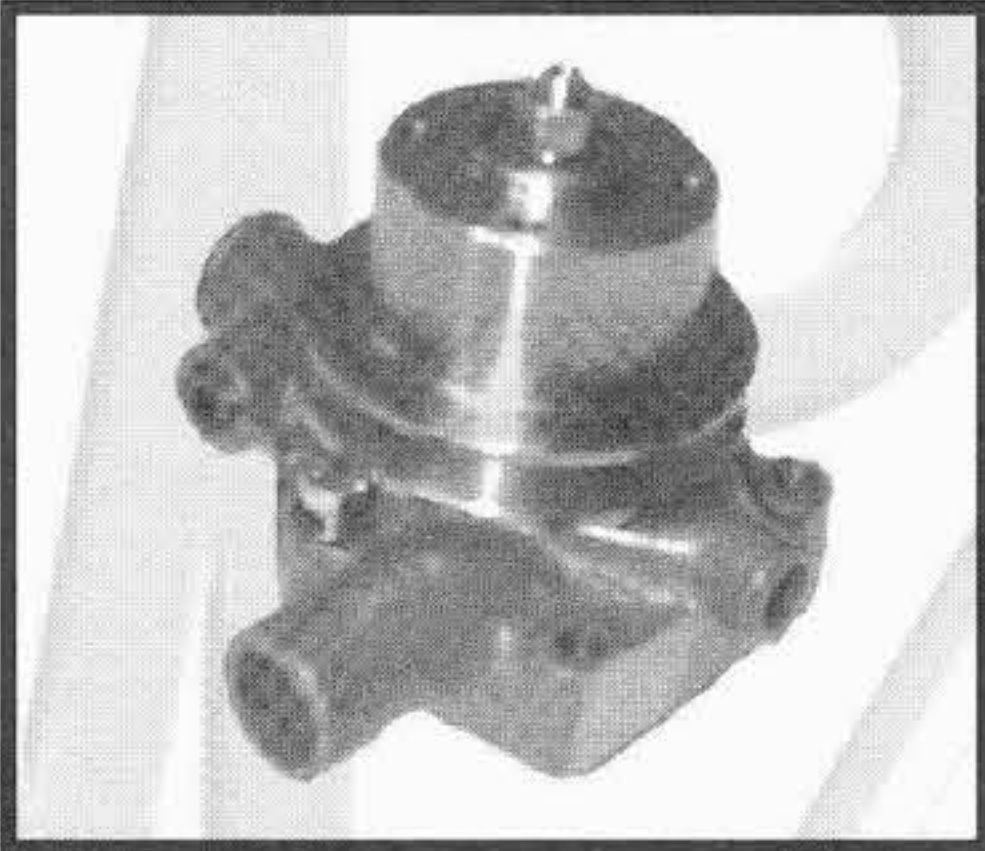
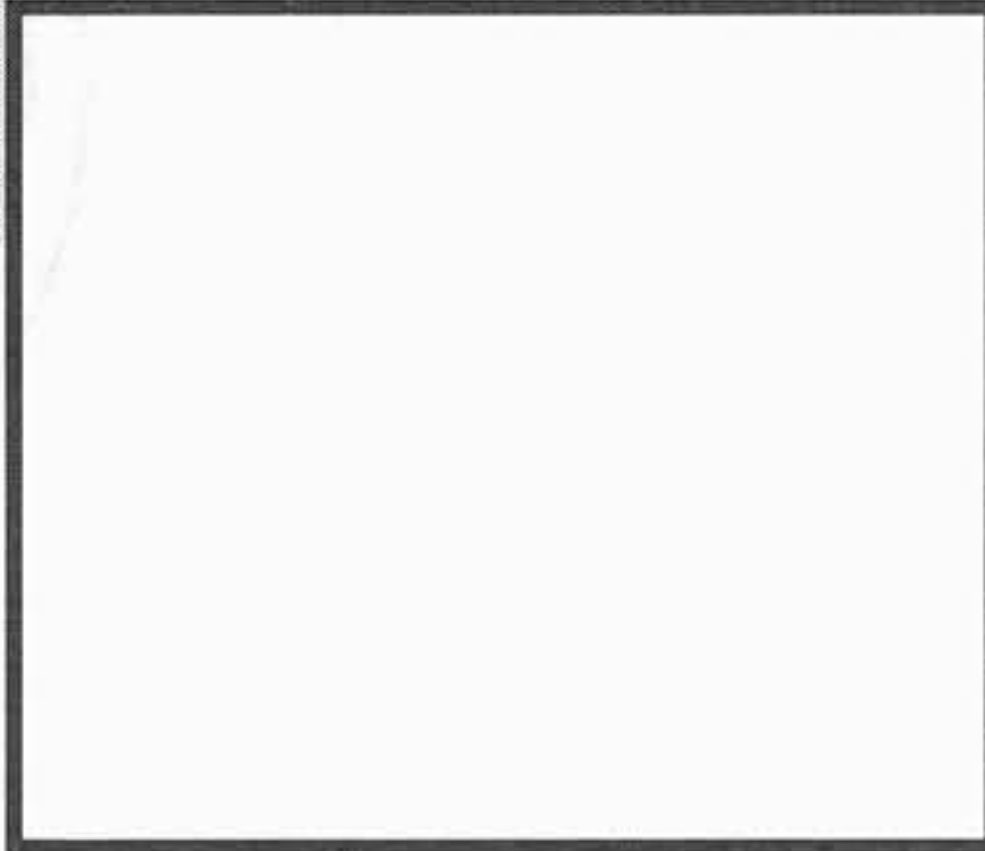
SUITABLE

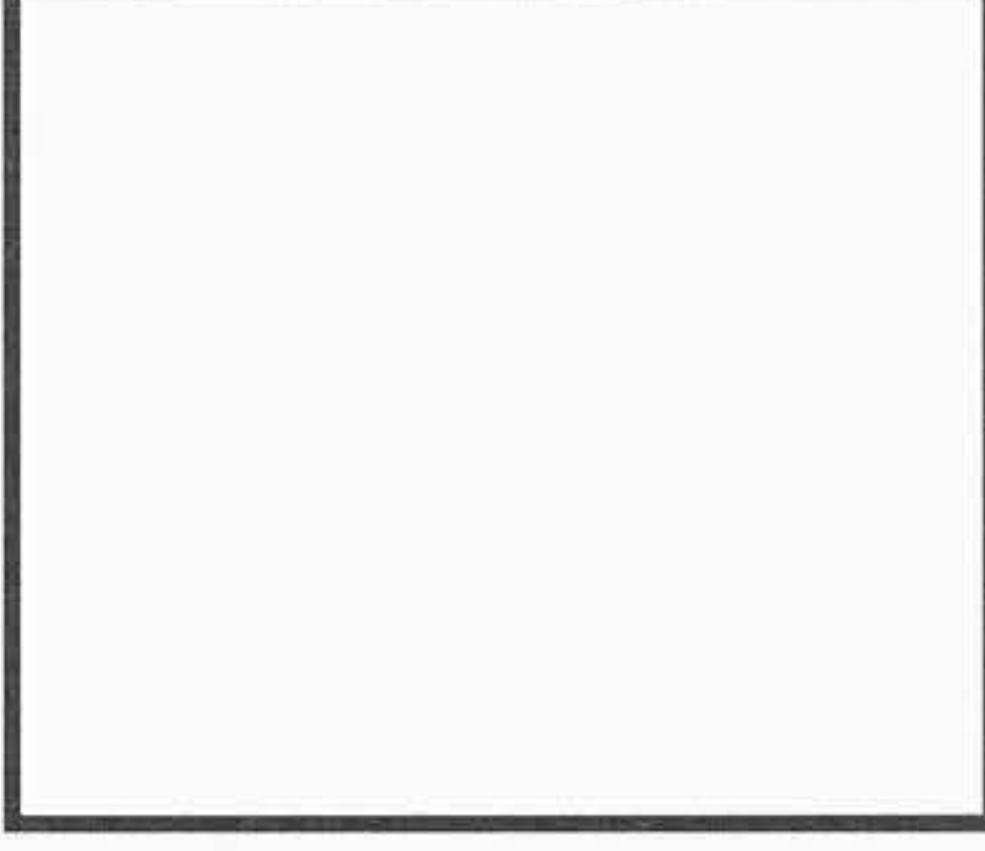
**EBRO****TRACTORS****Tel:+44(0)1925 850082 Fax: +(0)44 1925 850083****www.spwaterpumps.co.uk**

TIPO O MODELLO TYPE OU MODELE TYPE OR MODEL	MOTORE MOTEUR ENGINE	POMPA ACQUA POMPE A EAU WATER PUMP OMP REF. / O.EM. REF	KIT RIPARAZIONE NECESSAIRE DE REP. REPAIR KIT OMP REF. / O.EM. REF
2 T - 3 T  350	PERKINS 3.152	<b>259.050</b> 41312784 CON PULEGGIA / WITH PULLEY  <b>159.310</b> U5MW0023 SENZA PULEGGIA / WITHOUT PULLEY	<b>152.130</b> U7LW0044 
TA13 DHI  460	PERKINS D4.203 4.203	<b>259.040</b> 41312574 CON PULEGGIA / WITH PULLEY  <b>159.365</b> U5MW0061 SENZA PULEGGIA / WITHOUT PULLEY	<b>152.107</b> U7LW0027 
1.70/1 - 1.70/TA13  470 - 480 E  1022 - 6070  6075 - 6080	PERKINS D4.236 4.236 4.248 4.248	<b>259.450</b> 41313231P CON PULEGGIA / WITH PULLEY  <b>159.490</b> 4131A021 SENZA PULEGGIA / WITHOUT PULLEY	<b>152.183</b> U7LW0032 
100 C - 100 R  684 E	PERKINS 6.305	<b>259.110</b> 41312518 CON PULEGGIA / WITH PULLEY  <b>159.110</b> U5MW0019 SENZA PULEGGIA / WITHOUT PULLEY	<b>152.152</b> 58307 

I ricambi non sono originali ma adattabili . Ogni riferimento originale é assolutamente indicativo .

Spare parts are not original but perfectly suitable . Every original part number has to be considered for reference purpose only .



## **SECTION 15**

# **APPLICATION**

# **FENDT**

**WATER PUMPS WASSERPUMPEN  
POMPE A EAU BOMBA DE AGUA  
POMPA ACQUA**

**S.P. WATER PUMPS LTD  
18 Tatton Court, Kingsland Grange, Woolston,  
Warrington, Cheshire. ENGLAND. WAI 4RR  
TEL: +44(0) 1925 850082 Fax: +44(0) 1925 850083  
Email:sales@spwaterpumps.co.uk Web Site:www.spwaterpumps.co.uk**



SUITABLE





# FENDT

## TRACTORS

Tel:+44(0)1925 850082 Fax: +(0)44 1925 850083

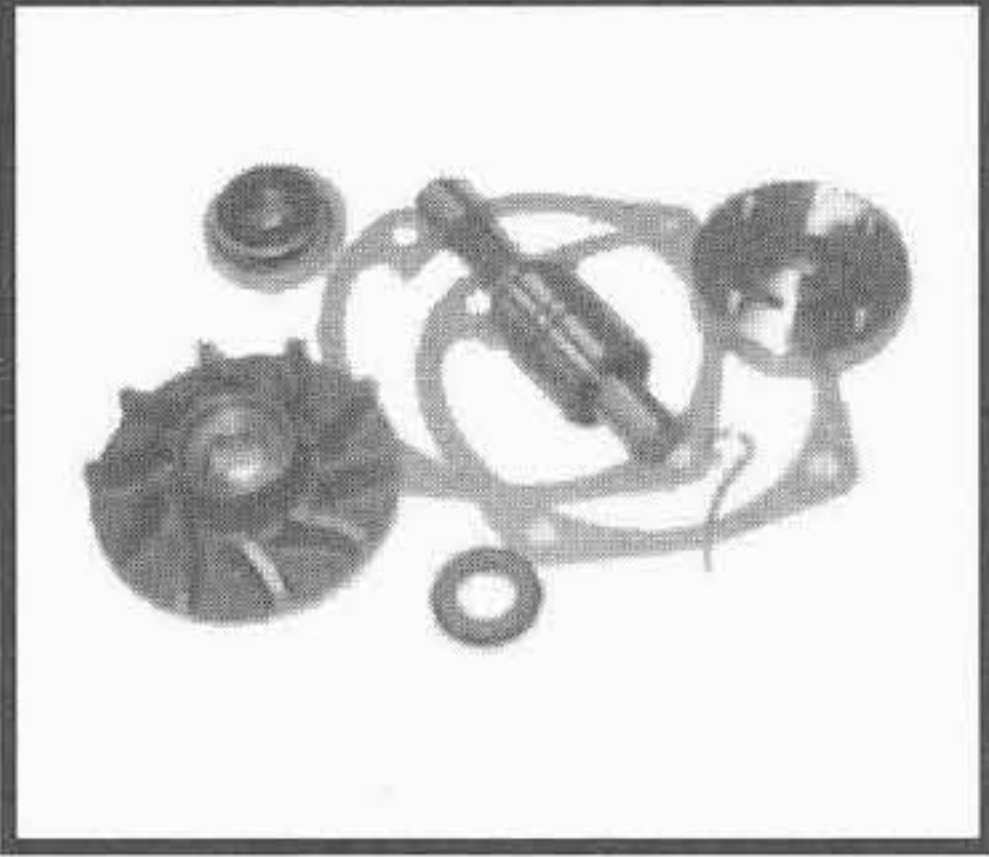
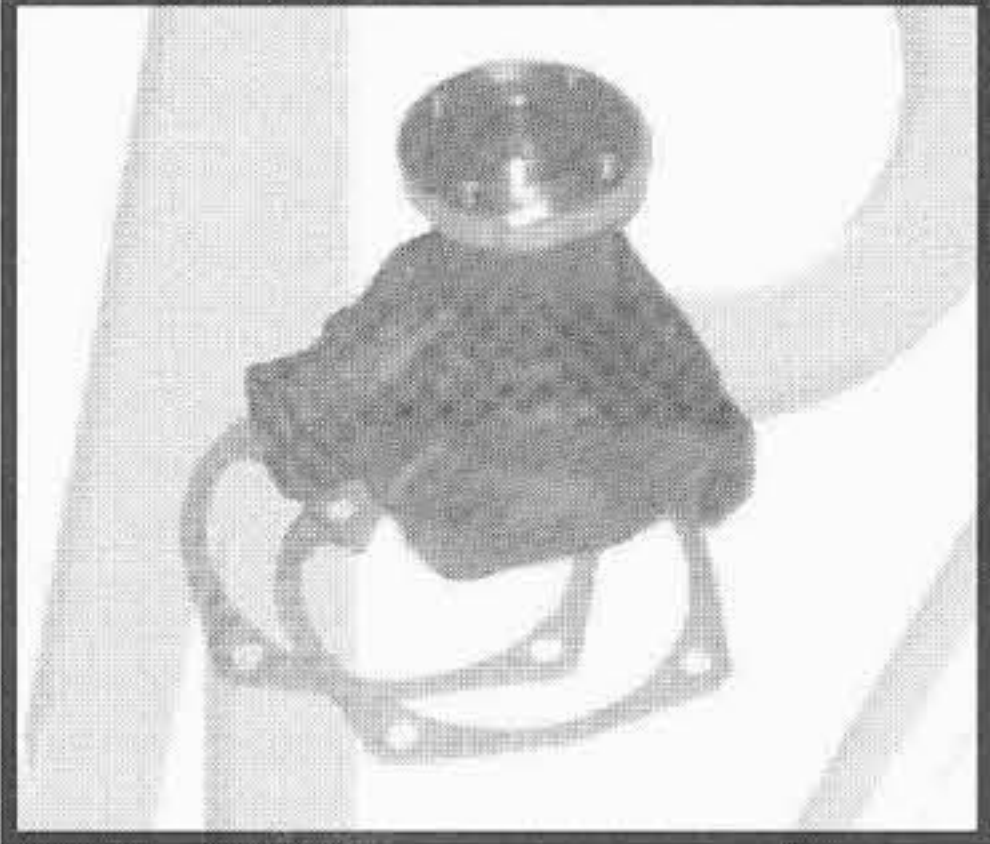
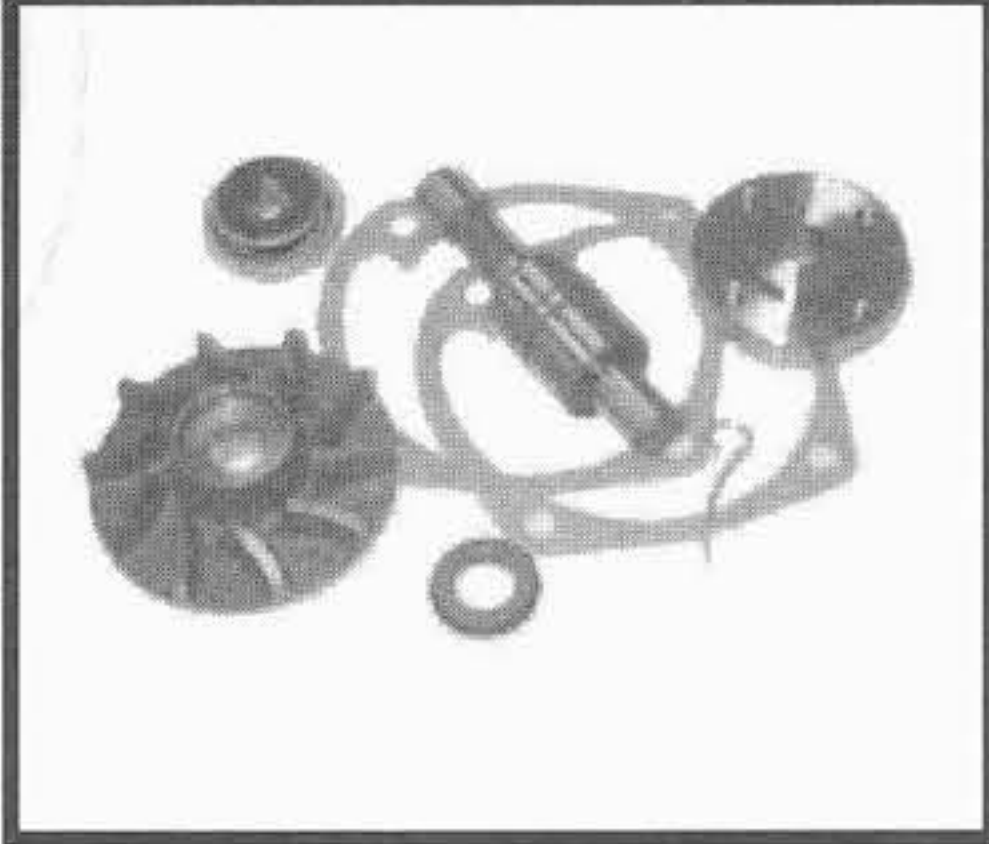
www.spwaterpumps.co.uk

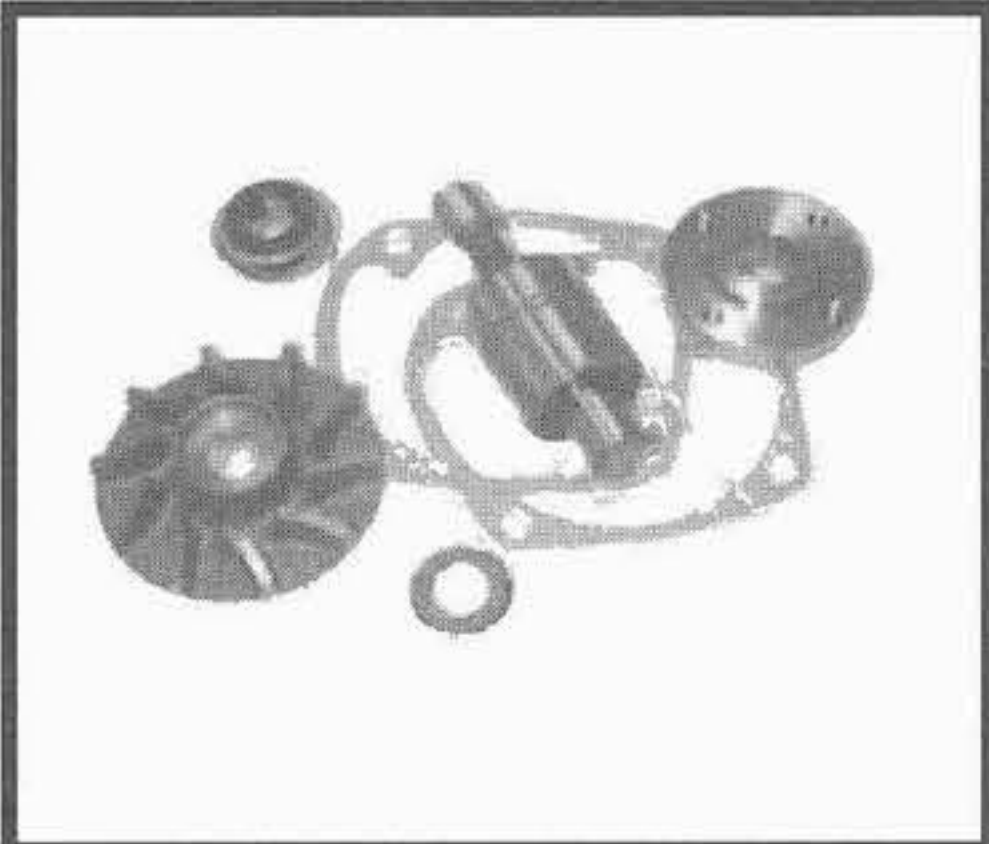

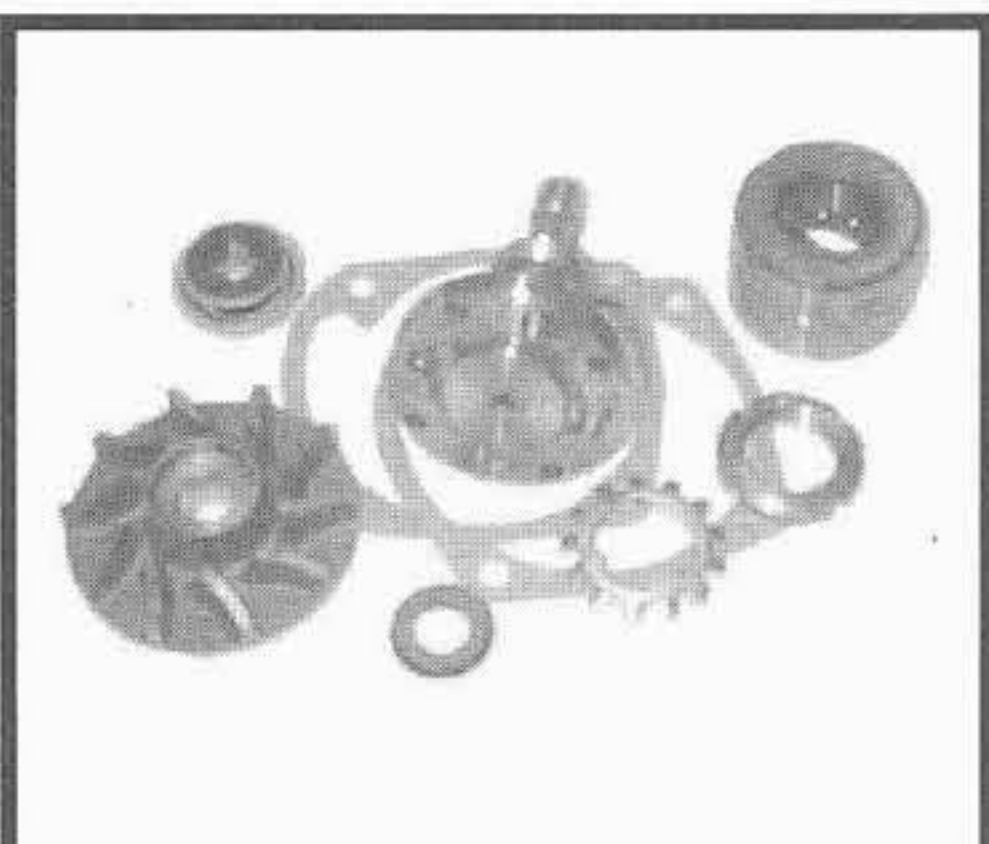
TIPO O MODELLO TYPE OU MODELE TYPE OR MODEL	MOTORE MOTEUR ENGINE	POMPA ACQUA POMPE A EAU WATER PUMP OMP REF. / O.EM. REF	KIT RIPARAZIONE NECESSAIRE DE REP. REPAIR KIT OMP REF. / O.EM. REF
<p>FARMER</p> <p>103 - 103 S 104 S - 105 105 S - 106 S - 108 S</p> <p>FAVORIT</p> <p>12 S - 610 S 611 S - 612 S</p>	<p>MWM D226-3 MWM D226-4 MWM D226-6</p>	<p>6.207.0.731.002.5</p> <div style="border: 1px solid black; padding: 10px; text-align: center;"> <p>SOST. DA : / REPLACE BY :</p> <p><b>363.160</b></p> </div> <p>PREMISTOPPA / SEAL Ø = 35 mm</p>	<p><b>362.089</b> -</p> <div style="border: 1px solid black; padding: 5px;">  </div>
<p>FARMER</p> <p>103 - 103 S 104 S - 105 105 S - 106 S - 108 S</p> <p>FAVORIT</p> <p>12 S - 610 S 611 S - 612 S</p>	<p>MWM D226-3 MWM D226-4 MWM D226-6</p>	<p><b>363.160</b> 6.226.0.731.006.5</p> <div style="border: 1px solid black; padding: 5px;">  </div> <p>F.281.200.610.010</p>	<p><b>362.090</b> 6.226.8.019.085.7</p> <div style="border: 1px solid black; padding: 5px;">  </div>
<p>300 SERIES</p> <p>WITH AIR CONDITIONING</p> <p>600 SERIES</p>	<p>MWM D226-3 MWM D226-4 MWM D226-6</p>	<p><b>363.295</b> 6.228.0.731.009.5</p> <div style="border: 1px solid black; padding: 5px;">  </div>	<p><b>362.282</b> -</p> <div style="border: 1px solid black; padding: 5px;">  </div>
<p>all version with ----&gt;</p>	<p>MWM D228</p>	<p><b>363.300</b> 6.228.0.731.015.5</p> <div style="border: 1px solid black; padding: 5px;">  </div> <p>F.382.200.610.020</p>	<p><b>362.284</b> -</p> <div style="border: 1px solid black; padding: 5px;">  </div> <p>F.385.200.610.021</p>

NEW !!

I ricambi non sono originali ma adattabili . Ogni riferimento originale é assolutamente indicativo .  
Spare parts are not original but perfectly suitable . Every original part number has to be considered for reference purpose only .



## **SECTION 17**

# **APPLICATION**

# **FORD**

## **INDUSTRIAL ENGINES**

**WATER PUMPS WASSERPUMPEN**  
**POMPE A EAU BOMBA DE AGUA**  
**POMPA ACQUA**

**S.P. WATER PUMPS LTD**  
18 Tatton Court, Kingsland Grange, Woolston,  
Warrington, Cheshire. ENGLAND. WAI 4RR  
TEL: +44(0) 1925 850082 Fax: +44(0) 1925 850083  
Email:sales@spwaterpumps.co.uk Web Site:www.spwaterpumps.co.uk

SUITABLE

# FORD

## INDUSTRIAL ENGINES

Tel:+44(0)1925 850082 Fax: +(0)44 1925 850083

www.spwaterpumps.co.uk



MOTORE  
MOTEUR  
ENGINE

POMPA ACQUA  
POMPE A EAU  
WATER PUMP

OMP REF.

O.EM. REF.

**2722**

**164.145**

826F8501ABA

6174469

**2725**

**4 CYL.**

**2726 T**

**6 CYL.**

**2726 TM**

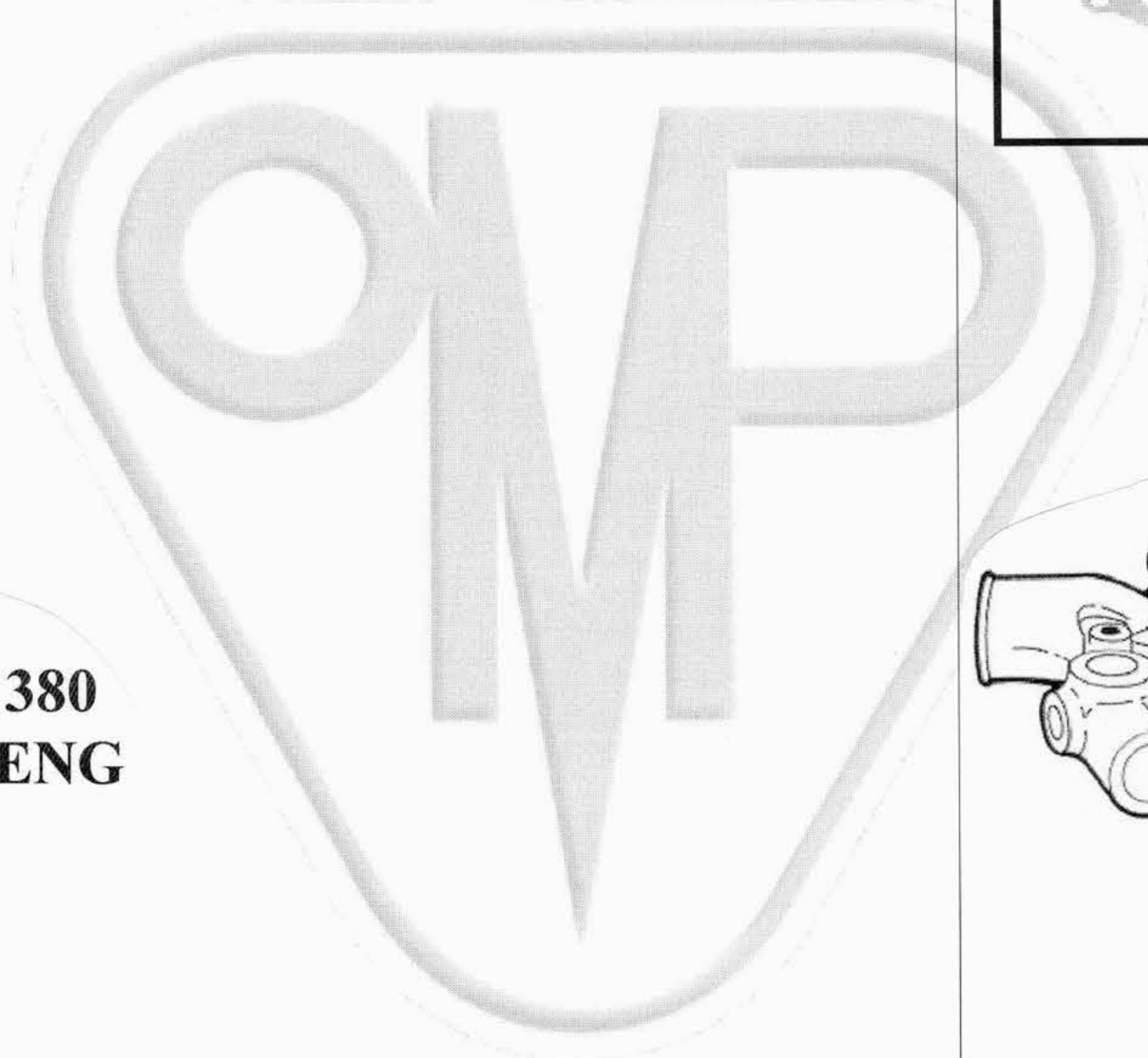
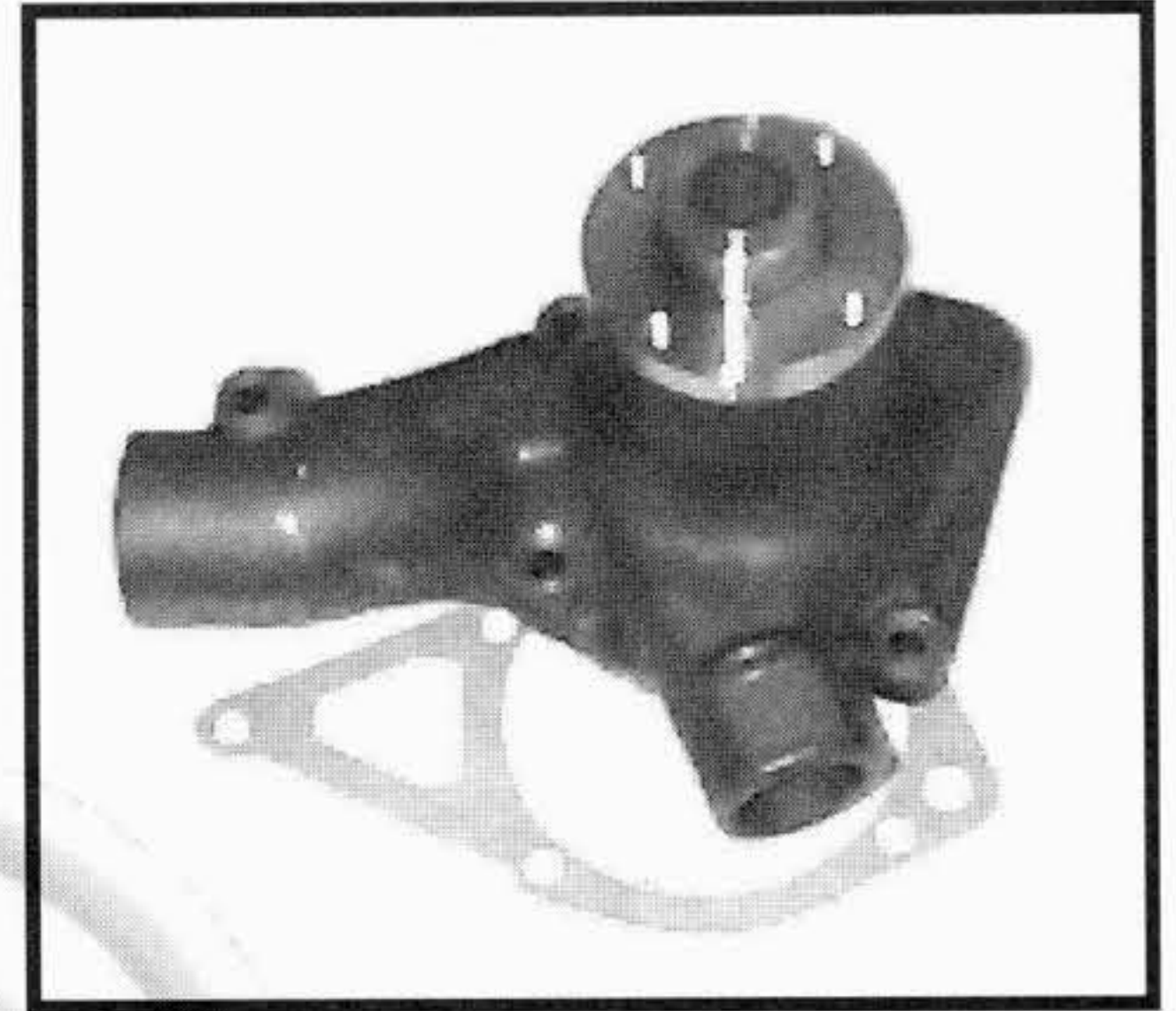

**5008468**  
**813, 365, 380**  
**DOVER ENG**

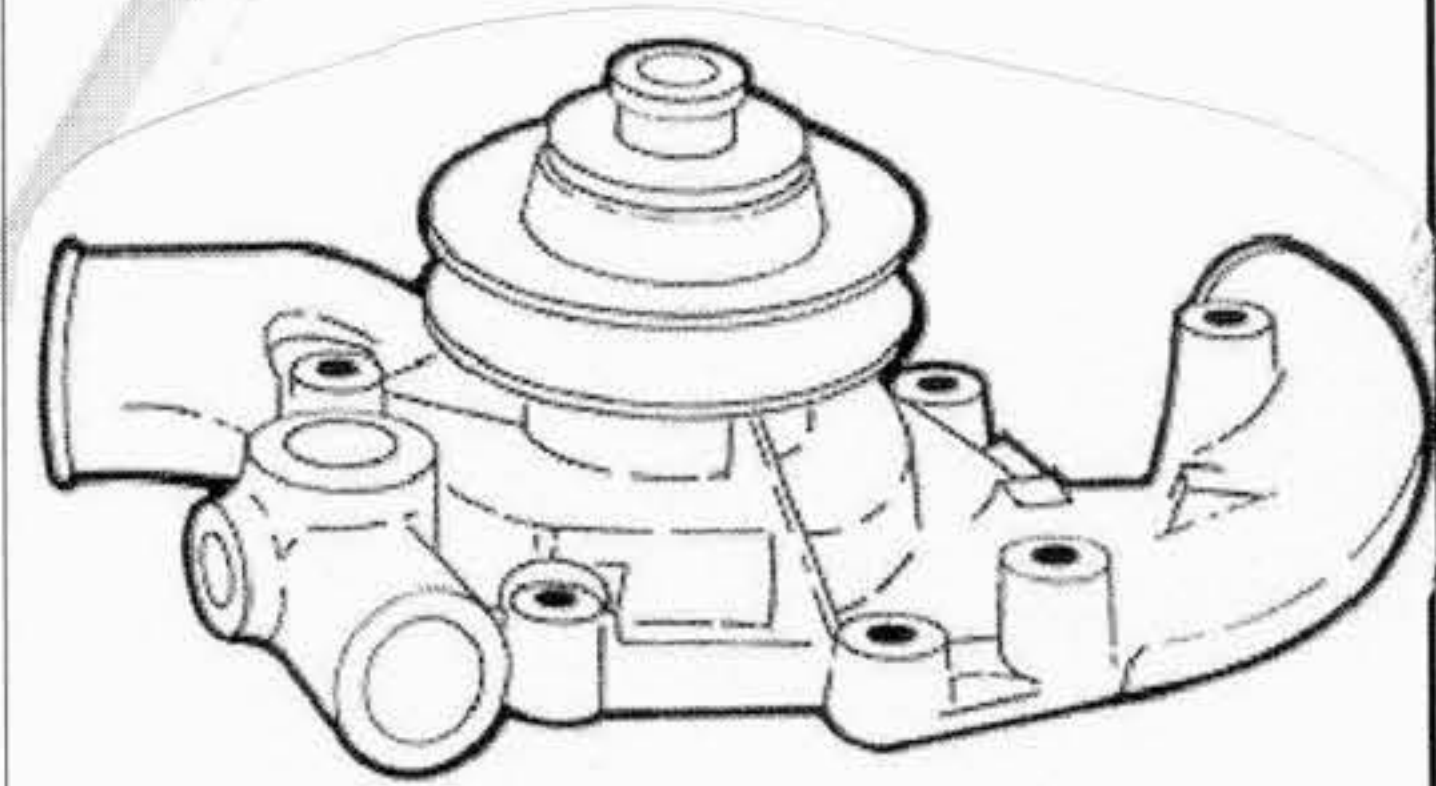

**5024545**  
**TRANSIT 2.5**

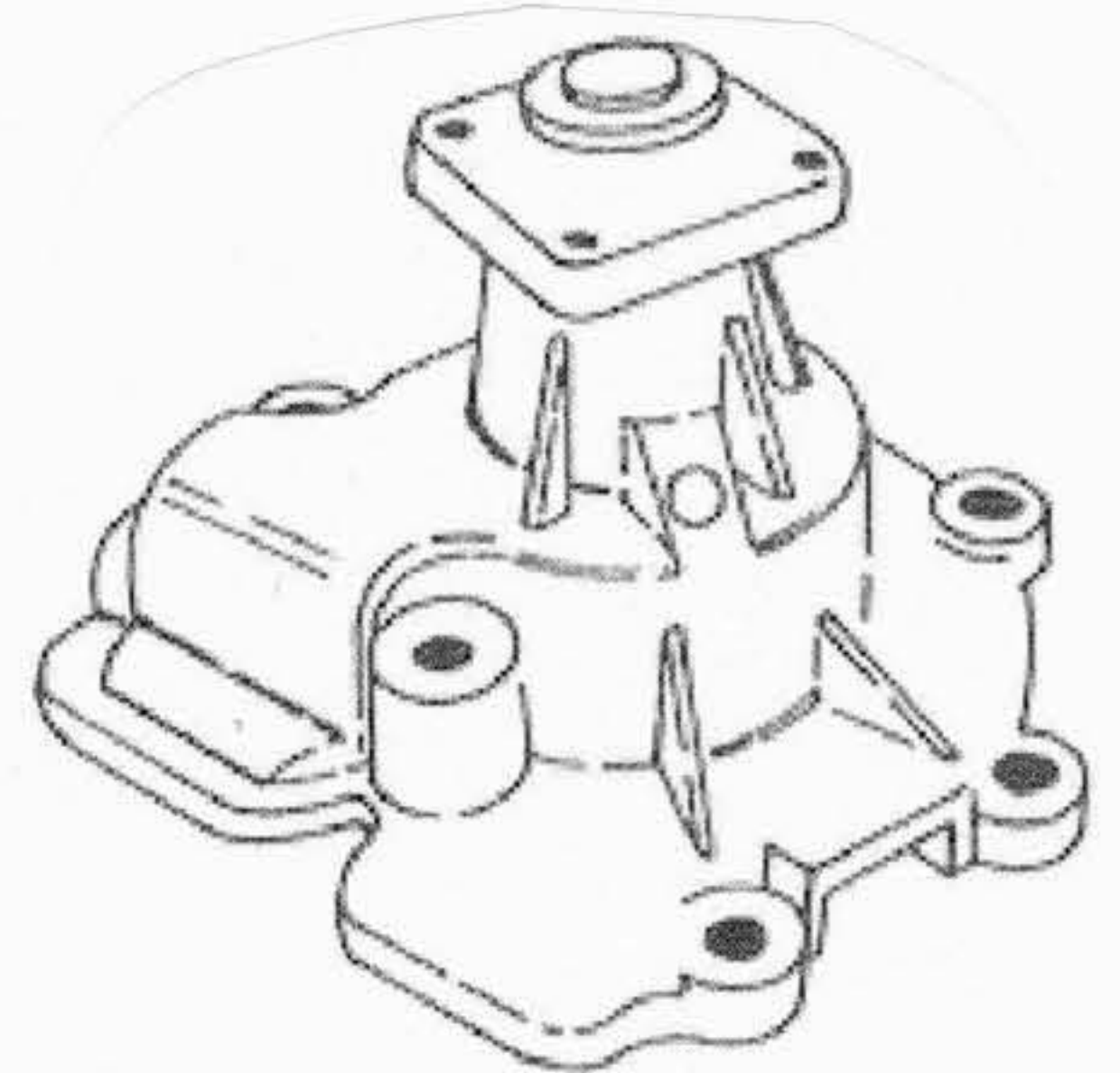





**SECTION 19/2**

**APPLICATION**

**HANOMAG**  
**HENSCHHEL**

**TRACTORS**

**WATER PUMPS WASSERPUMPEN**  
**POMPE A EAU BOMBA DE AGUA**  
**POMPA ACQUA**

**S.P. WATER PUMPS LTD**  
18 Tatton Court, Kingsland Grange, Woolston,  
Warrington, Cheshire. ENGLAND. WAI 4RR  
TEL: +44(0) 1925 850082 Fax: +44(0) 1925 850083  
Email:sales@spwaterpumps.co.uk Web Site:www.spwaterpumps.co.uk

SUITABLE

# HANOMAG HENSCHEL TRACTORS

Tel: +44(0)1925 850082 Fax: +(0)44 1925 850083

www.spwaterpumps.co.uk

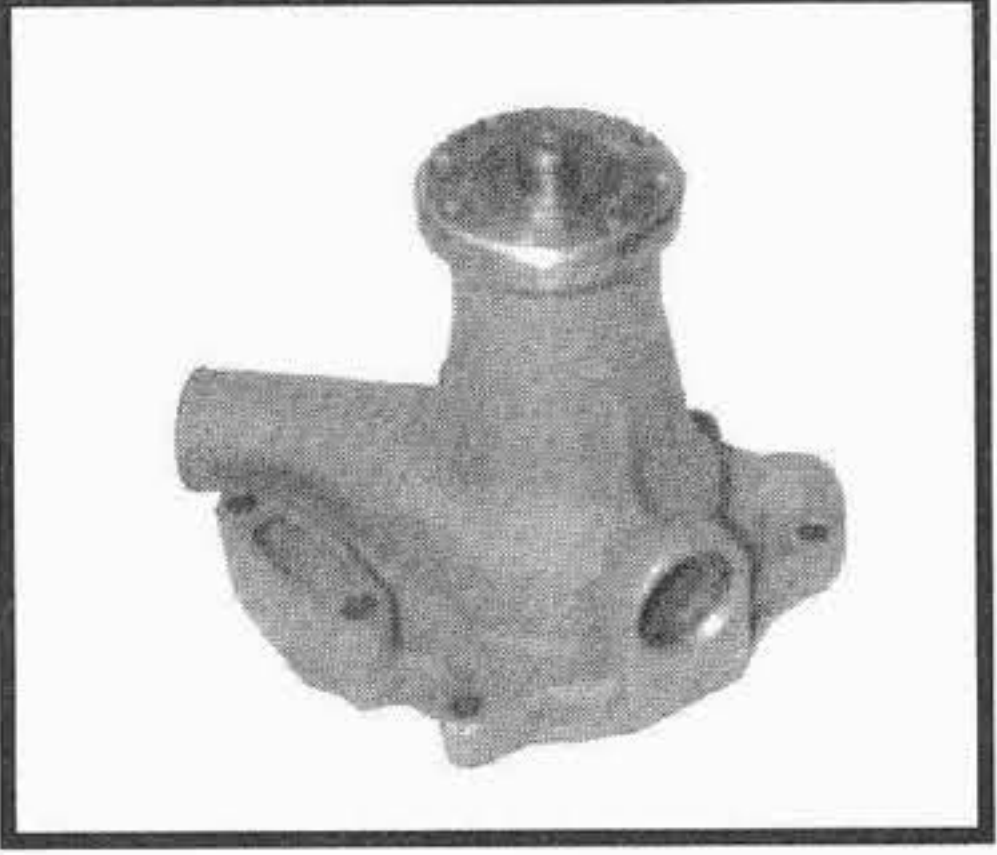
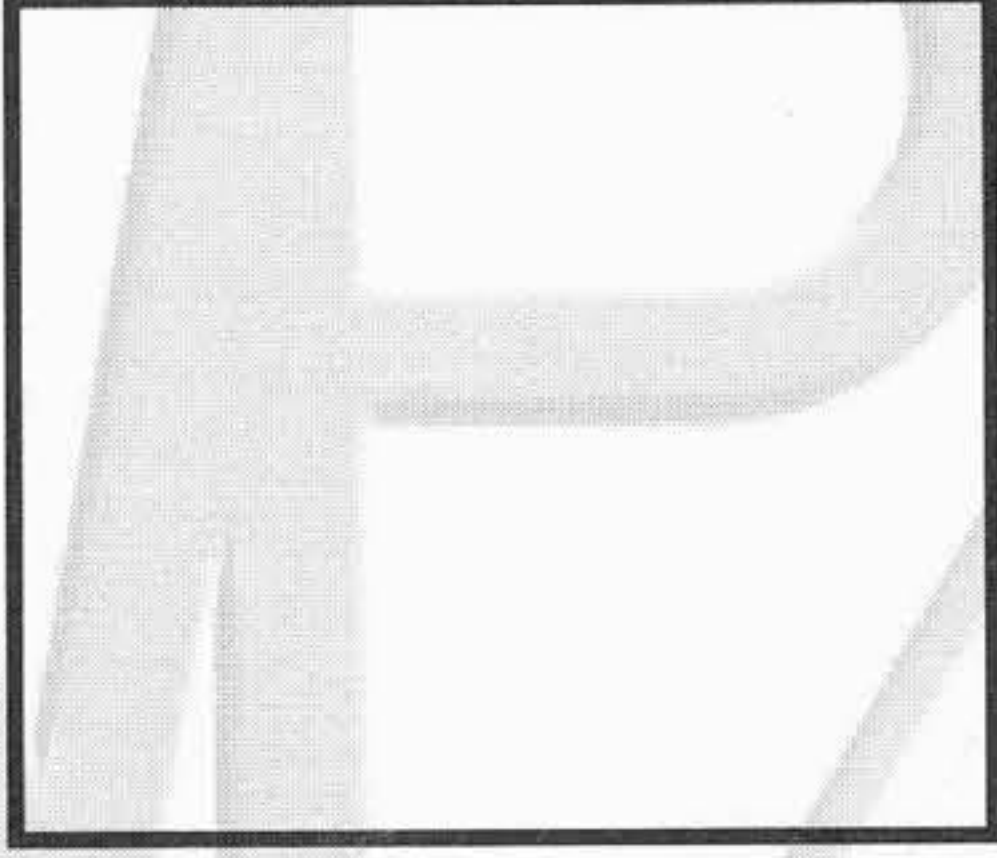
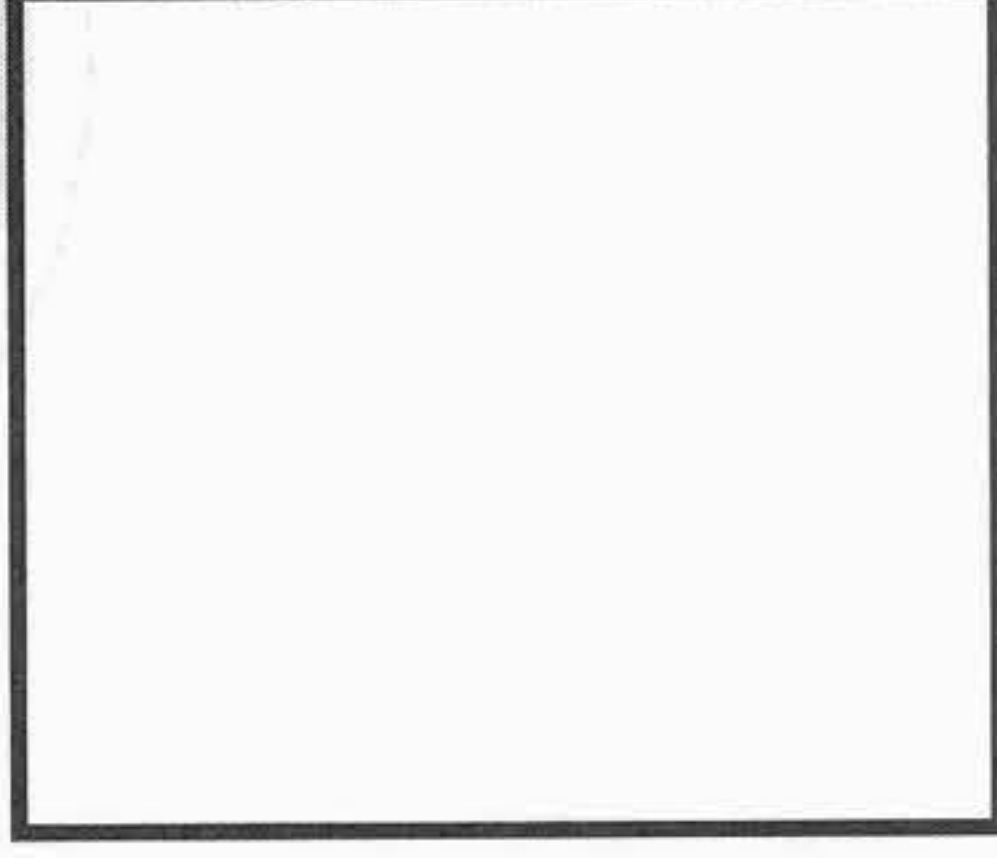
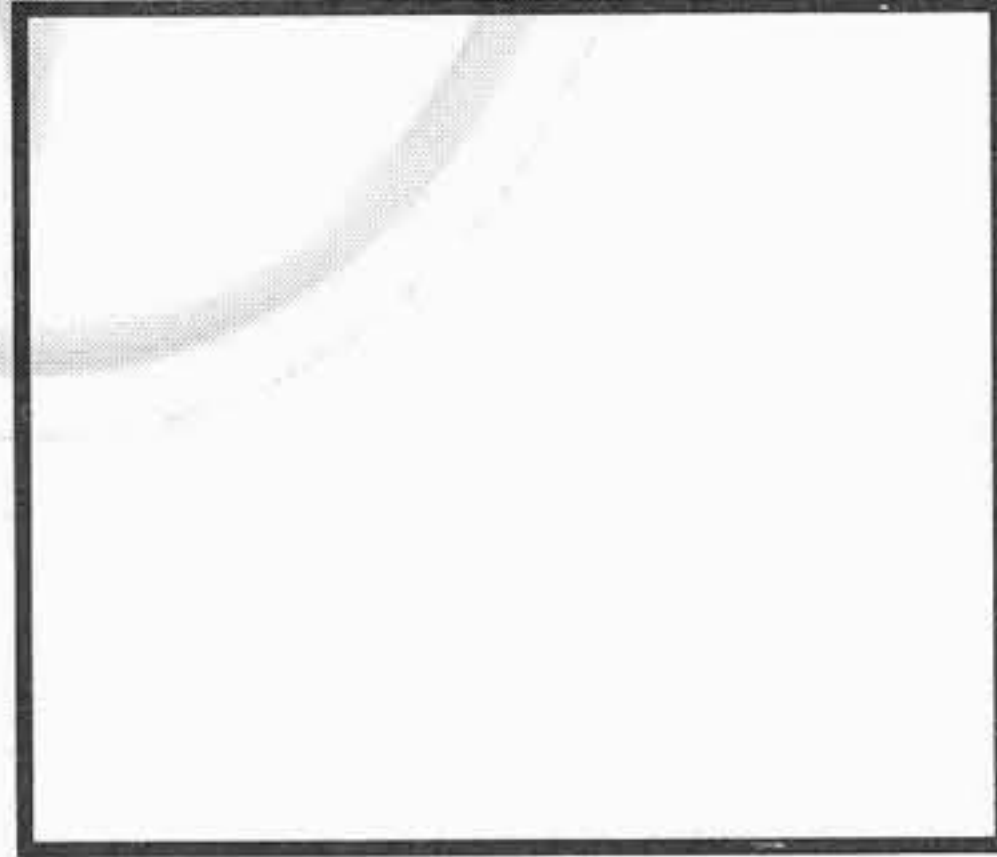
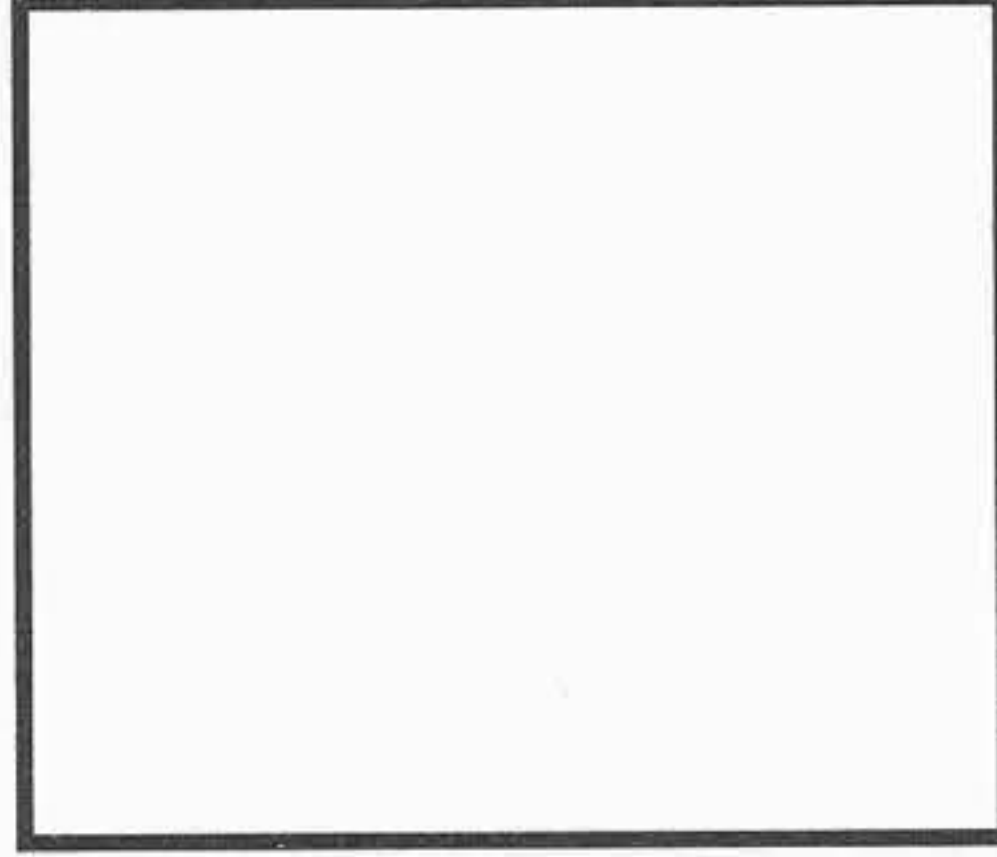
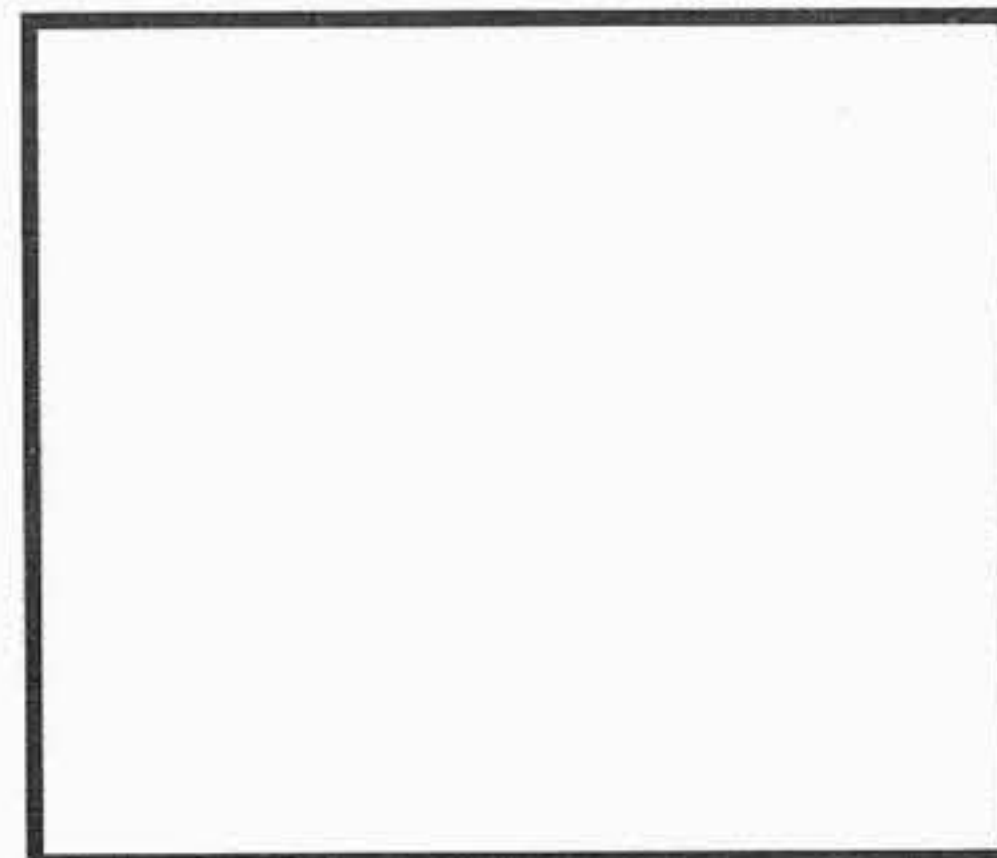
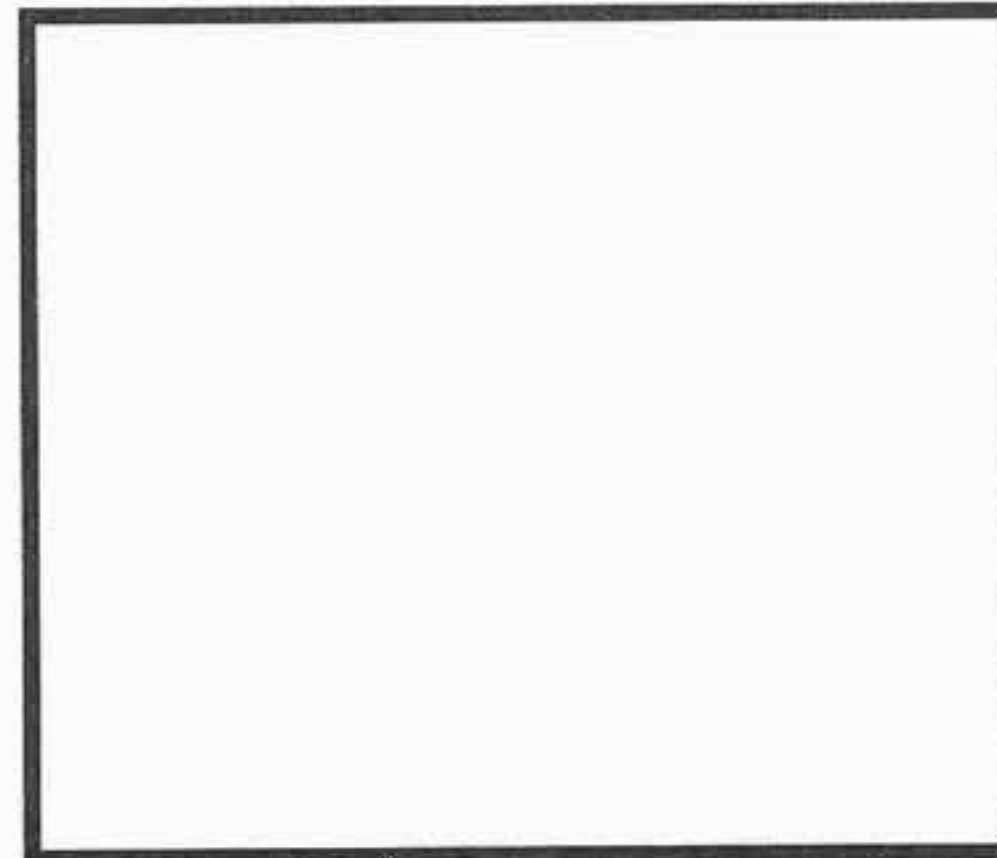

TIPO O MODELLO TYPE OU MODELE TYPE OR MODEL	MOTORE MOTEUR ENGINE	POMPA ACQUA POMPE A EAU WATER PUMP	KIT RIPARAZIONE NECESSAIRE DE REP. REPAIR KIT
K 5	D 142 K	381.000 X86.0114.9207.54	---
B 6	D 142 B		<p style="text-align: center;"><b>NON DISPONIBILE</b> <b>NOT AVAILABLE</b></p>
K 32	D 142 K		
K 32	D 142 K		
K 45	D 142 K	ex X86.0114.9207.46	
			
			
			

I ricambi non sono originali ma adattabili . Ogni riferimento originale é assolutamente indicativo .  
Spare parts are not original but perfectly suitable . Every original part number has to be considered for reference purpose only .



## **SECTION 24**

# **APPLICATION**

**JOHN  
DEERE**

**WATER PUMPS WASSERPUMPEN  
POMPE A EAU BOMBA DE AGUA  
POMPA ACQUA**

**S.P. WATER PUMPS LTD**  
18 Tatton Court, Kingsland Grange, Woolston,  
Warrington, Cheshire. ENGLAND. WAI 4RR  
TEL: +44(0) 1925 850082 Fax: +44(0) 1925 850083  
Email:sales@spwaterpumps.co.uk Web Site:www.spwaterpumps.co.uk



SUITABLE

# JOHN DEERE

Tel: +44(0)1925 850082 Fax: +(0)44 1925 850083

www.spwaterpumps.co.uk

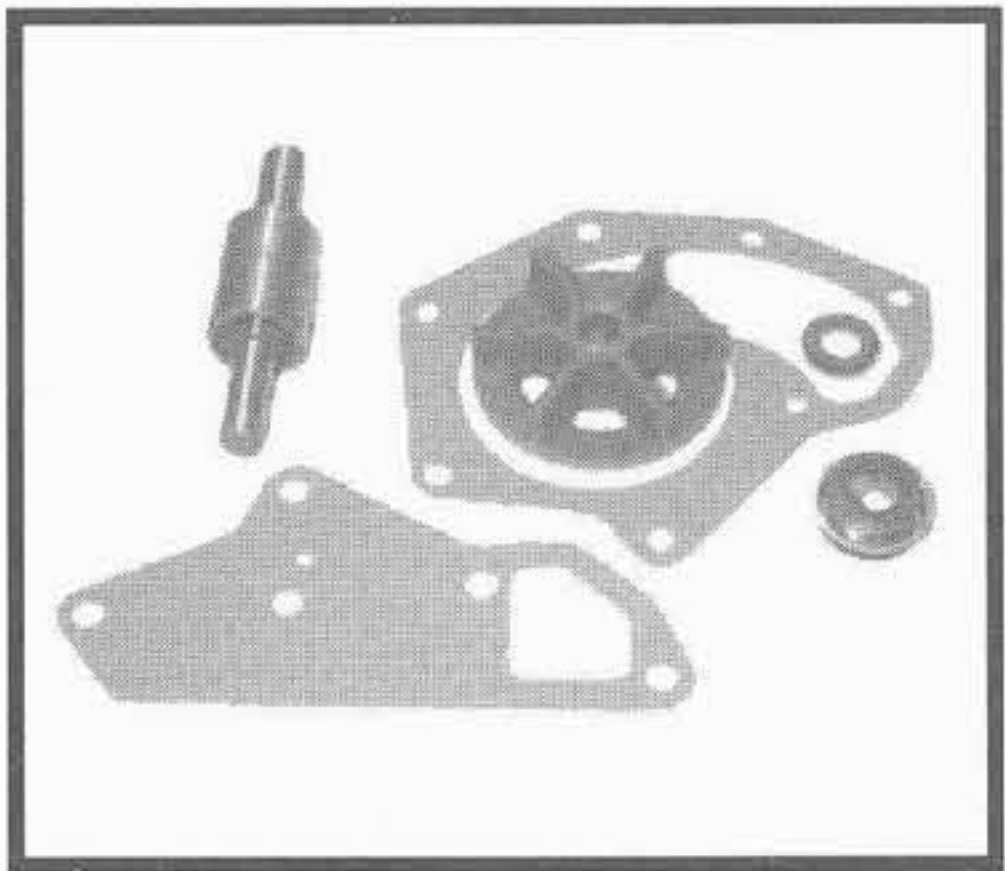
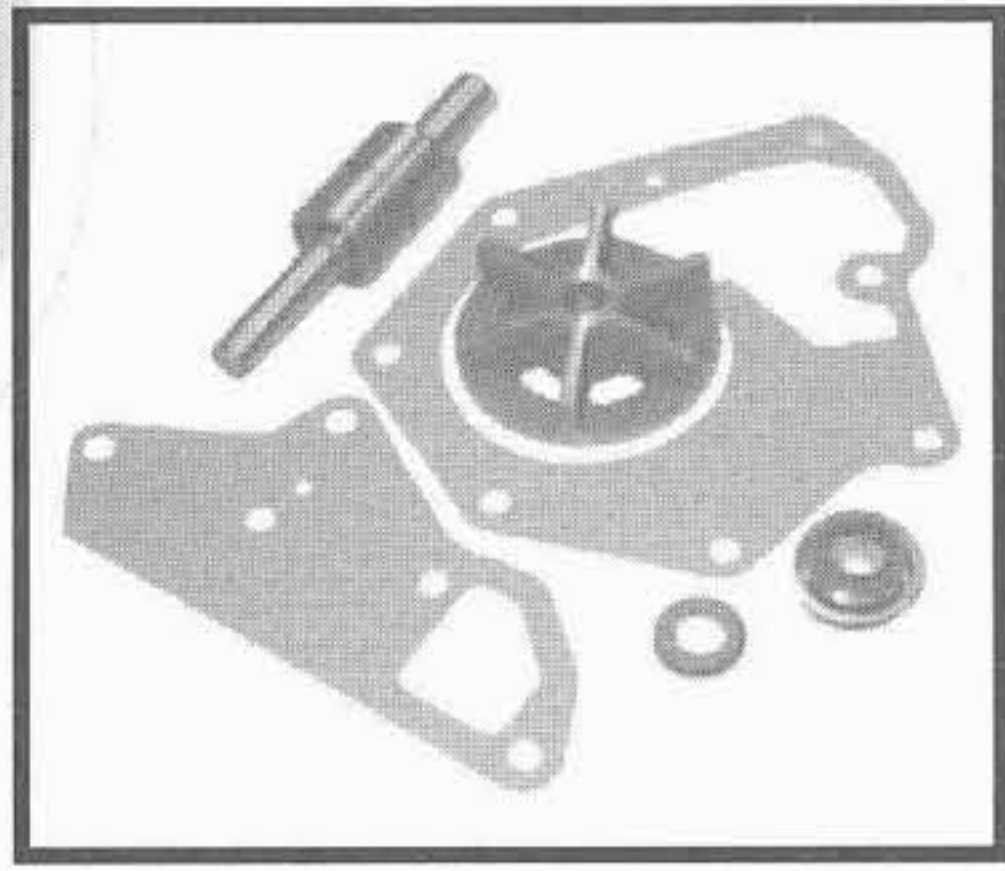
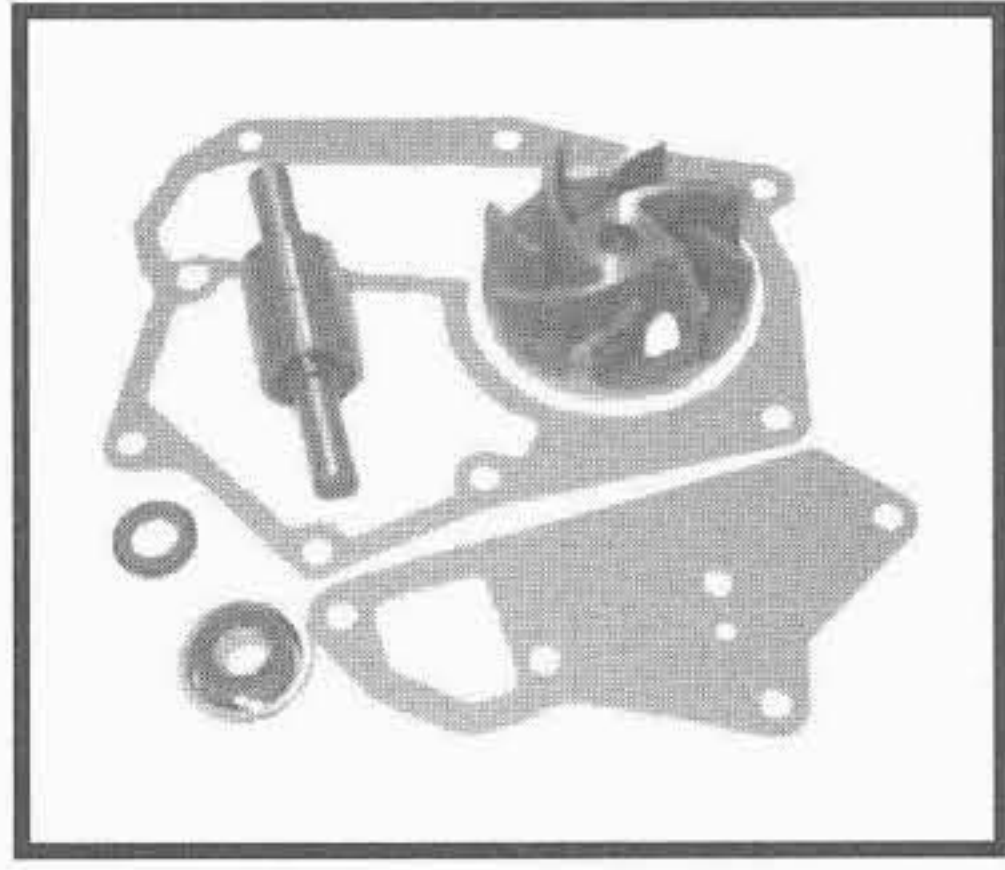
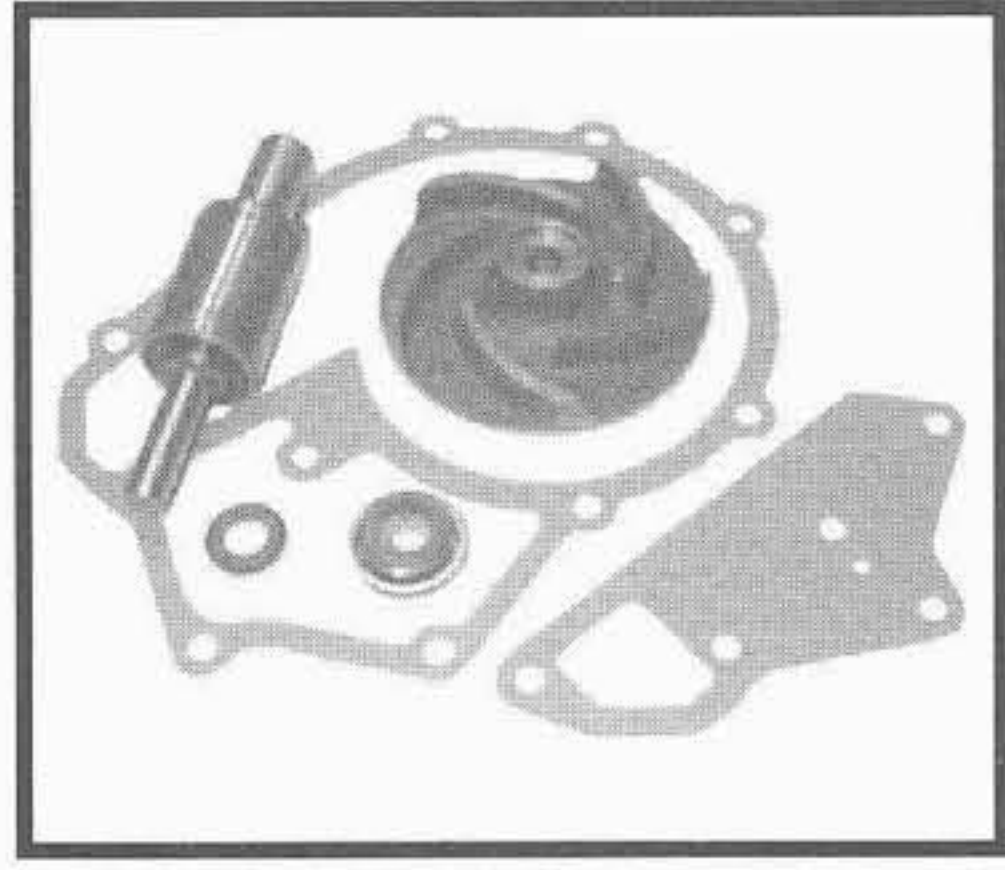

TIPO O MODELLO TYPE OU MODELE TYPE OR MODEL	MOTORE MOTEUR ENGINE	POMPA ACQUA POMPE A EAU WATER PUMP	OMP REF. / O.EM. REF	KIT RIPARAZIONE NECESSAIRE DE REP. REPAIR KIT	OMP REF. / O.EM. REF
820 - 920 - 1020 1120 - 2120  930 - 1030 - 1130 1630 - 1830 2030 - 2130	4 CYL.	-	-	<b>412.000</b> RE 11345 	RE 11345
940 - 1040 - 1140 1640 - 1840 2040 - 2040 S 2140	4 CYL.	-	-	<b>412.002</b> RE 11347 	RE 11347
3030 3120 3130	6 CYL.	-	-	<b>412.001</b> RE 11346 	RE 11346
3040 3140 4040	6 CYL.	-	-	<b>412.003</b> RE 11348 	RE 11348

I ricambi non sono originali ma adattabili . Ogni riferimento originale é assolutamente indicativo .  
 Spare parts are not original but perfectly suitable . Every original part number has to be considered for reference purpose only .



**SECTION 29**

**APPLICATION**

**LANDINI**

**TRACTORS**

**WATER PUMPS WASSERPUMPEN  
POMPE A EAU BOMBA DE AGUA  
POMPA ACQUA**

**S.P. WATER PUMPS LTD  
18 Tatton Court, Kingsland Grange, Woolston,  
Warrington, Cheshire. ENGLAND. WAI 4RR  
TEL: +44(0) 1925 850082 Fax: +44(0) 1925 850083  
Email:sales@spwaterpumps.co.uk Web Site:www.spwaterpumps.co.uk**

TAVOLE DI CONVERSIONE  
TABLE DE CONVERSION  
CONVERSION TABLE

LANDINI



NUMERO ORIGINALE NUMERO ORIGINAL ORIGINAL NUMBER	NUMERO SOSTITUTIVO REPLACE PAR NUMERO REPLACED BY NUMBER	RIFERIMENTO OMP REFERENCE OMP OMP REFERENCE
32346		259.066
58293	89019	
68575	U7LW0015	
85707	86948	252.154
85800	U7LW0025	
86948	U7LW0055	
86957	U7LW0029	
89007	U7LW0024	
89019	U7LW0044	
89034	U7LW0006	
0030927		259.058
0040057		259.058
0080268		
0170040		251.184
0170046		259.009
0380098		259.053
0380164		259.051
0490484		259.068
0490690		259.064
0500006		251.191
0524406		259.028
0576005		259.006
0576007		259.031
0650540		259.041
0670165		259.305
0748419		259.071
0920007		251.201
0920009		259.032
0920056		259.037
0920058		251.772
0920106		251.381
0994650		259.130
0994658	41312038	
2232133		259.072
2415209	2415216	
2415213		259.136
2415216		251.042
2417204		259.141
2417208		259.022
2431154		259.041
2564406		259.028
2418M001	2418M004	
2418M004		259.428
2418M007		159.428
2418M011		156.206
2521D406		259.158
2721A530		251.354

NUMERO ORIGINALE NUMERO ORIGINAL ORIGINAL NUMBER	NUMERO SOSTITUTIVO REPLACE PAR NUMERO REPLACED BY NUMBER	RIFERIMENTO OMP REFERENCE OMP OMP REFERENCE
31142691		259.335
31145630		259.035
31145713		259.315
31145741		259.085
31146362		259.135
31146952		259.015
31155232		259.205
32753417		259.056
32764119	3276P003	
32764124		259.078
32764127	3276P003	
3276P003		259.014
3312K011		259.156
3312K012		251.204
33143112		259.024
33143409		259.077
33157108		259.019
33157109		259.017
33157144		259.037
33415136		259.039
33811314		259.052
33813313		259.018
33814115		259.038
36866271		259.042
36866724	36866271	
36867108		259.101
36867137		259.087
37447192		259.061
37447603		259.076
37447632		259.084
37447680		259.143
37477232		259.059
37711262		259.063
37711301		259.129
37711321		259.089
37711530		259.067
37711632		259.016
37711892		259.381
37712330		259.201
37712390		
37712470		259.291
37712540	37712541	
37712541		259.221
37712630		259.134
3771F011		159.391
41312038	41312063	
41312054	41312055	

OGNI RIFERIMENTO ORIGINALE E' ASSOLUTAMENTE INDICATIVO. CHAQUE REFERENCE ORIGINAL EST ABSOLUMENT INDICATIVE. EVERY ORIGINAL PART NUMBER HAS TO BE CONSIDERED FOR REFERENCE PURPOSE ONLY.

TAVOLE DI CONVERSIONE  
TABLE DE CONVERSION  
CONVERSION TABLE

LANDINI



NUMERO ORIGINALE NUMERO ORIGINAL ORIGINAL NUMBER	NUMERO SOSTITUTIVO REPLACE PAR NUMERO REPLACED BY NUMBER	RIFERIMENTO OMP REFERENCE OMP OMP REFERENCE
41312055	41312494	
41312059	41312159	
41312143	41312201	
41312159	41312416	
41312201	41312219	
41312219	41312245	
41312245	41312246	
41312246	41312248	
41312248	41312251	
41312323	41312325	
41312325	41312348	
41312348	41312349	
41312349	41312351	
41312351	41312354	
41312354	41312356	
41312356	41312358	
41312358	41312366	
41312366	41312379	
41312379	41312551	
41312416	41312487	
41312419	VEDI U5MW0014	
41312459		259.370
41312486	VEDI U5MW0057	
41312487		259.080
41312491	VEDI U5MW0057	
41312493	VEDI U5MW0057	259.300
41312536		259.310
41312551	41312552	
41312552	41312554	
41312554	41312561	
41312561	41312562	
41312562	41312564	
41312564	41312566	
41312566	41312568	
41312568	41312689	
41312689	41312756	
41312698	41312906	
41312723	VEDI U5MW0014	
41312747	VEDI U5MW0014	
41312756	41312908	
41312768	VEDI U5MW0023	
41312783	VEDI U5MW0023	
41312784		259.050
41312785	VEDI U5MW0023	
41312786	VEDI U5MW0023	
41312806	VEDI U5MW0016	
41312807	VEDI U5MW0016	

NUMERO ORIGINALE NUMERO ORIGINAL ORIGINAL NUMBER	NUMERO SOSTITUTIVO REPLACE PAR NUMERO REPLACED BY NUMBER	RIFERIMENTO OMP REFERENCE OMP OMP REFERENCE
41312808	VEDI U5MW0016	
41312809	VEDI U5MW0016	
41312828	VEDI U5MW0014	
41312892	= 41312574	
41312906	41312907	
41312907	41313018	
41312911	41312913	
41312913	41312915	
41312915	41312918	
41312918	41313201	
41313027		159.355
41313201	41313225	
41313225	41313231	
41313231	4131A013	159.450
41313232	4131A021	159.460
4131A013	4131A021	159.480
4131A021	4131A029	
4131A029	4131A034	
4131A034		159.490
4131E002	4131E005	
4131E005	4131E007	
4131E007	4131E012	
4131E011		159.500
4131E012		159.510
4131E105	4131E011	
U5MW0006	U5MW0057	
U5MW0014		159.140
U5MW0016		159.230
U5MW0023		159.310
U5MW0054		159.370
U5MW0057		159.375
U5MW0092	4131E011	
U7 LW0006	U7 LW0029	
U7 LW0015		152.153
U7 LW0024		252.136
U7 LW0025		152.112
U7 LW0027		152.107
U7 LW0029	U7 LW0032	
U7 LW0032	U7 LW0058	
U7L W0034	U7L W0071	
U7 LW0044		152.130
U7 LW0055		152.155
U7 LW0058		152.183
U7 LW0071		152.260
U7 LW0087		152.261

OGNI RIFERIMENTO ORIGINALE E' ASSOLUTAMENTE INDICATIVO. CHAQUE REFERENCE ORIGINAL EST ABSOLUMENT INDICATIVE. EVERY ORIGINAL PART NUMBER HAS TO BE CONSIDERED FOR REFERENCE PURPOSE ONLY.



SUITABLE







# LANDINI

## TRACTORS

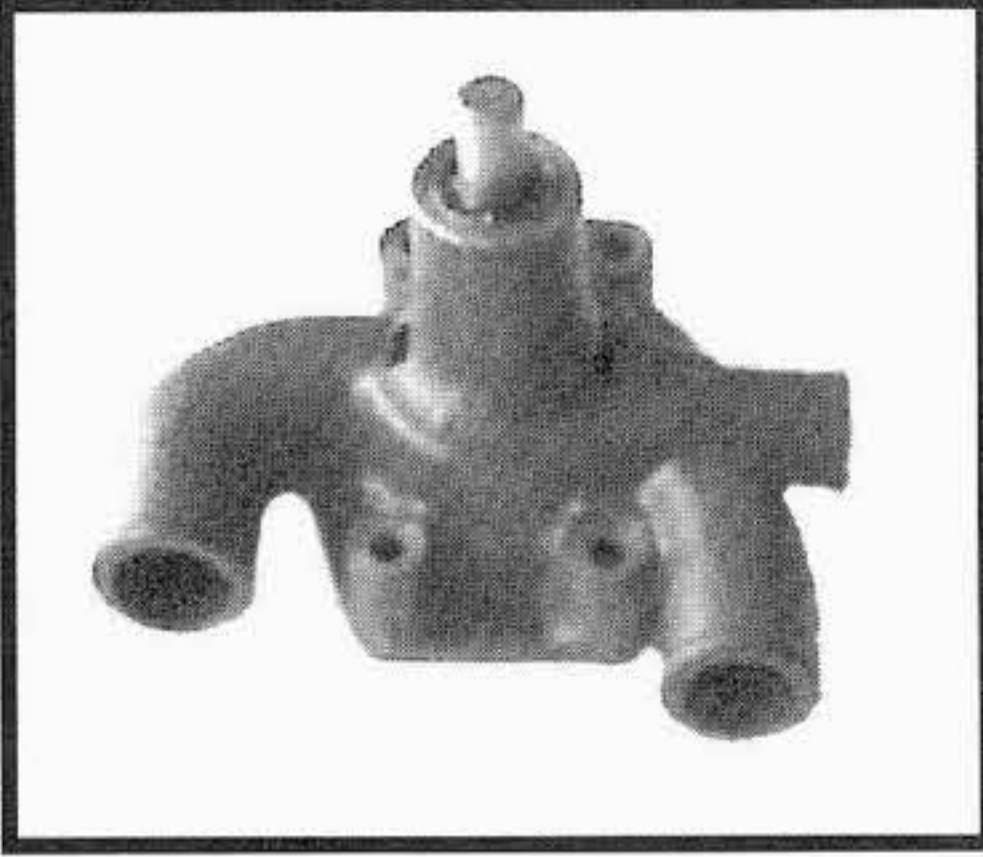
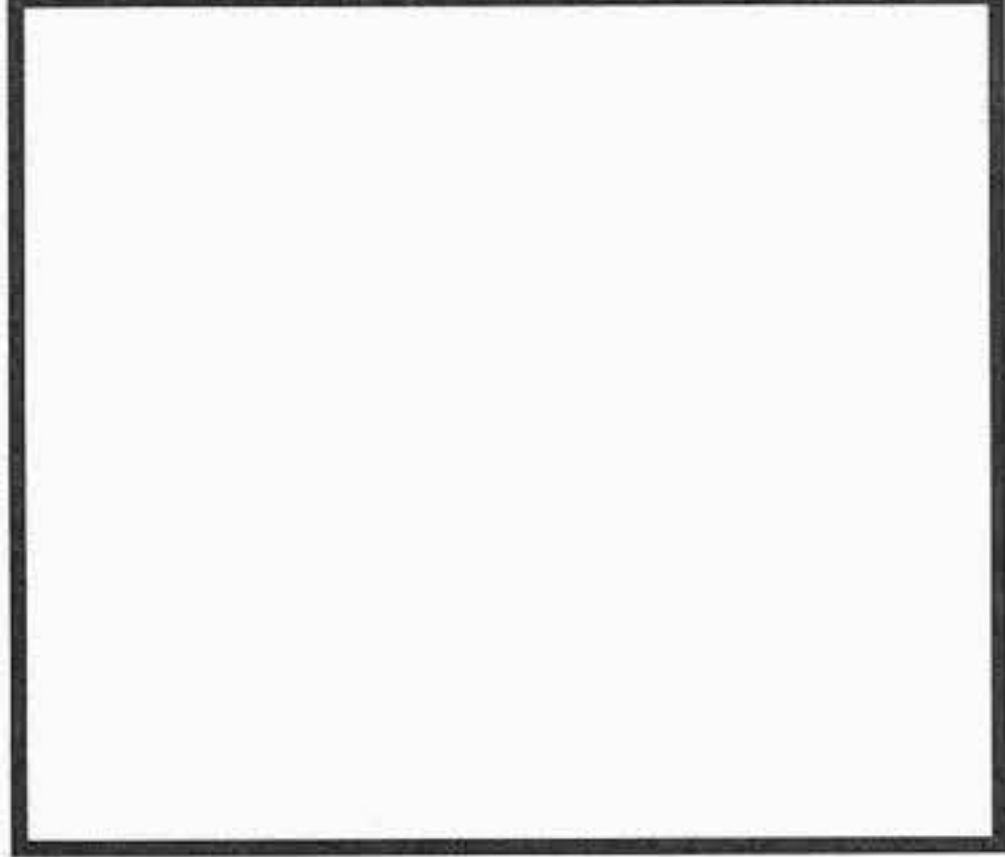
Tel: +44(0)1925 850082 Fax: +(0)44 1925 850083

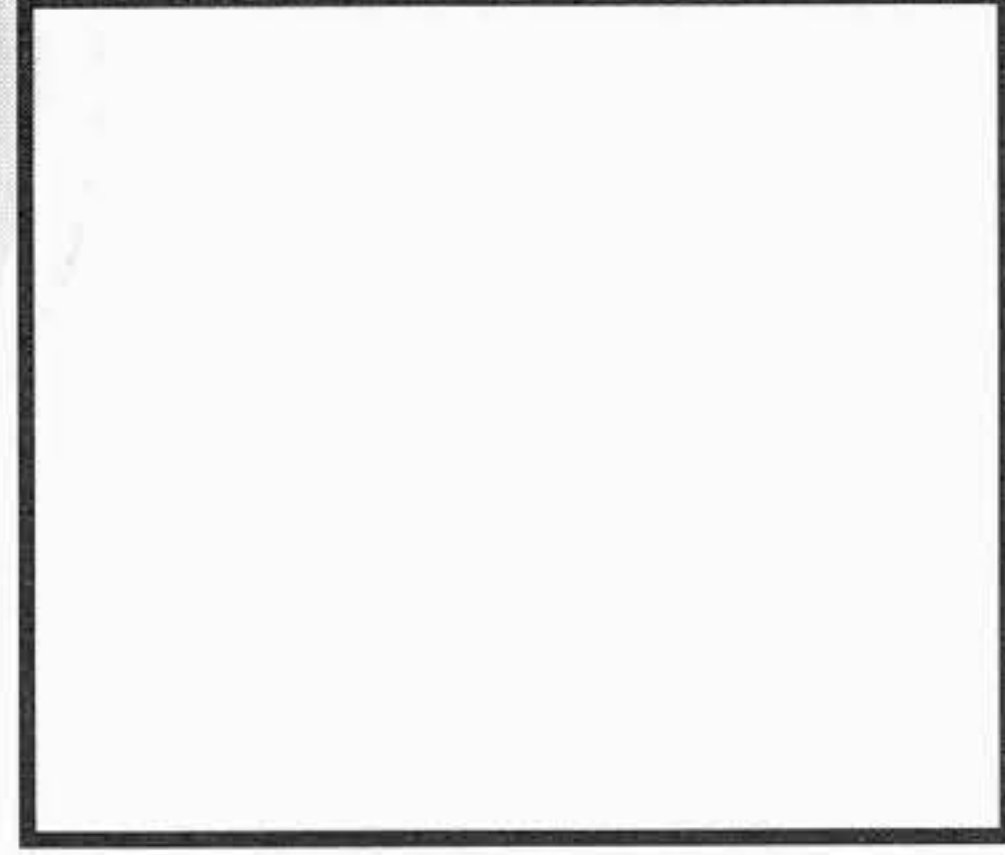
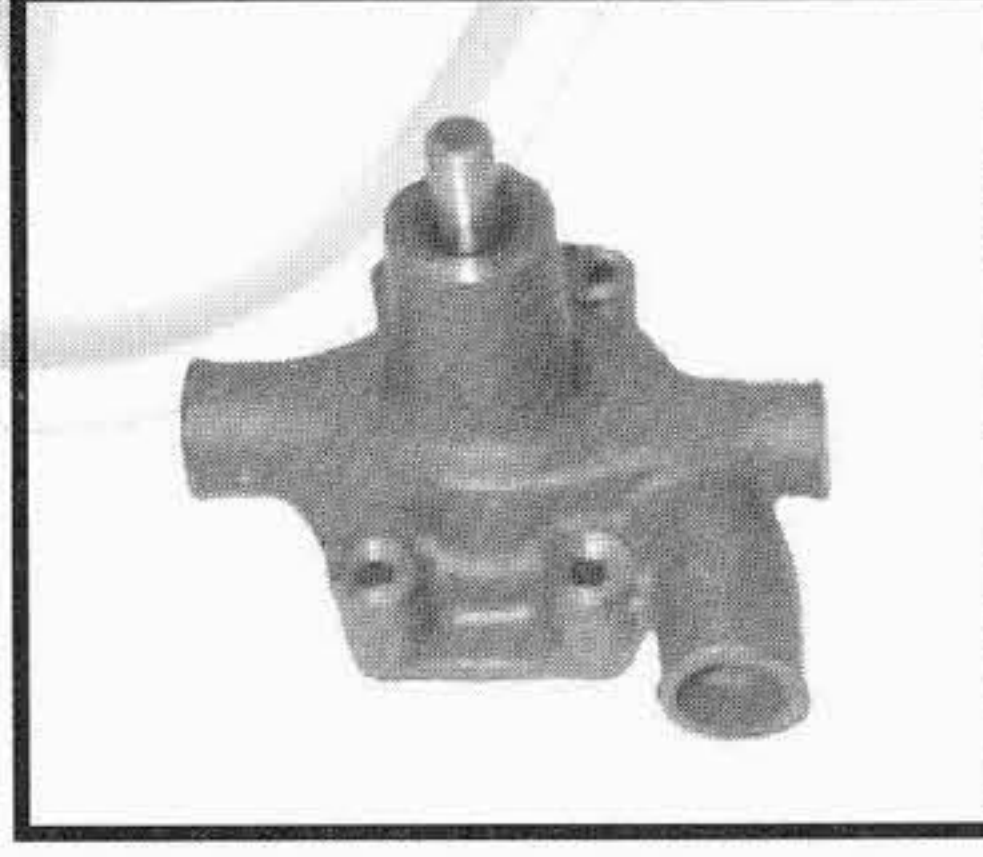
www.spwaterpumps.co.uk



TIPO O MODELLO TYPE OU MODELE TYPE OR MODEL	MOTORE MOTEUR ENGINE	POMPA ACQUA POMPE A EAU WATER PUMP OMP REF. / O.EM. REF	KIT RIPARAZIONE NECESSAIRE DE REP. REPAIR KIT OMP REF. / O.EM. REF
R 4000 C 4000 R 4500 C 4500 C 5000	D3.152	<p><b>159.310</b> U5MW0023 SENZA PULEGGIA / WITHOUT PULLEY</p>  <p>--- 41312784 CON PULEGGIA / WITH PULLEY</p>	<p><b>152.130</b> U7LW0044</p> 
R 4500 C 4500 R 5500 C 5500	A3.152	<p><b>259.080</b> 41312487 CON PULEGGIA / WITH PULLEY</p>  <p><b>159.310</b> U5MW0023 SENZA PULEGGIA / WITHOUT PULLEY</p>	<p><b>152.130</b> U7LW0044</p> 
R 5000	AD3.152	<p><b>159.375</b> U5MW0057 SENZA PULEGGIA / WITHOUT PULLEY</p>  <p>--- 41312493 CON PULEGGIA / WITH PULLEY</p>	<p><b>152.130</b> U7LW0044</p> 
TL 19C TL 21C MF 2345	D3.152	<p><b>259.050</b> 41312784 CON PULEGGIA / WITH PULLEY</p>  <p><b>159.310</b> U5MW0023 SENZA PULEGGIA / WITHOUT PULLEY</p>	<p><b>152.130</b> U7LW0044</p> 

I ricambi non sono originali ma adattabili . Ogni riferimento originale é assolutamente indicativo .  
Spare parts are not original but perfectly suitable . Every original part number has to be considered for reference purpose only .

SUITABLE



# LANDINI

## TRACTORS

Tel: +44(0)1925 850082 Fax: +44(0)1925 850083

www.spwaterpumps.co.uk

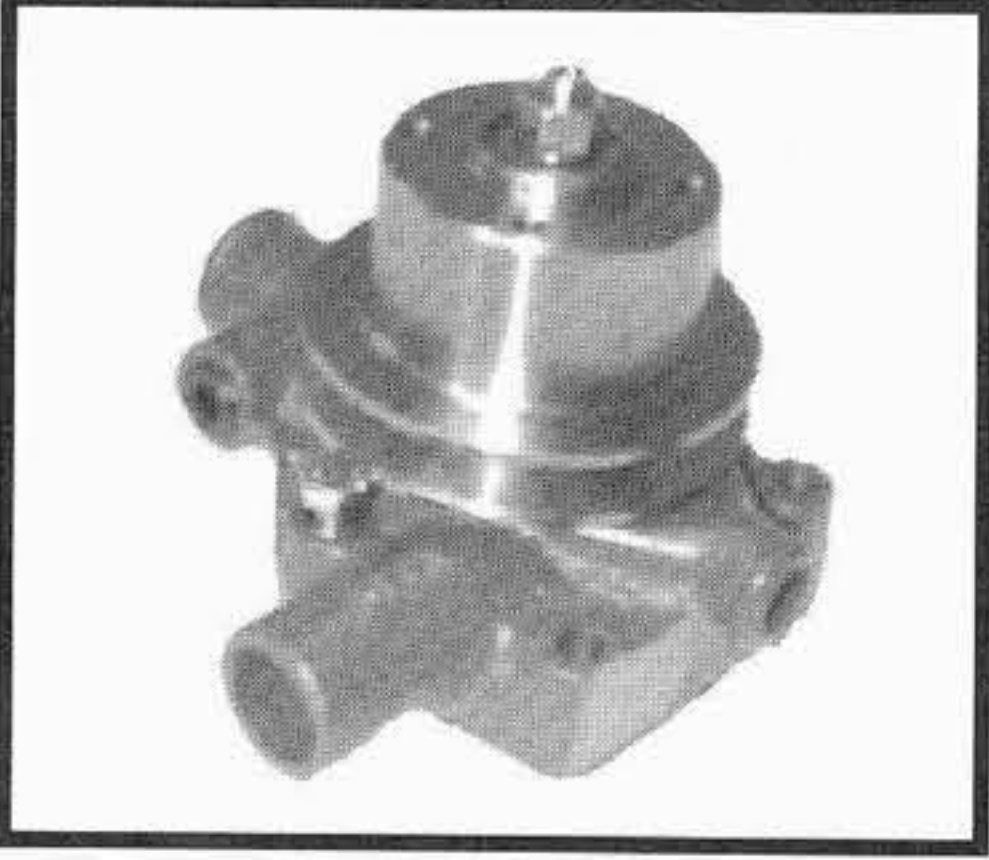
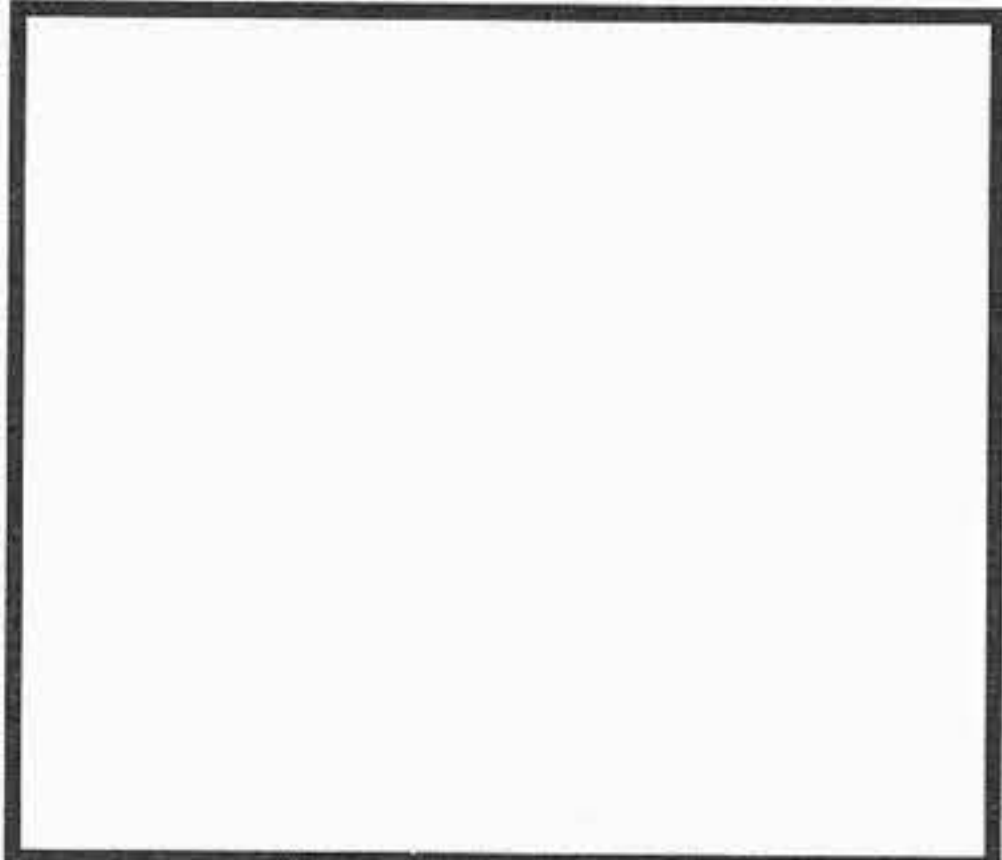
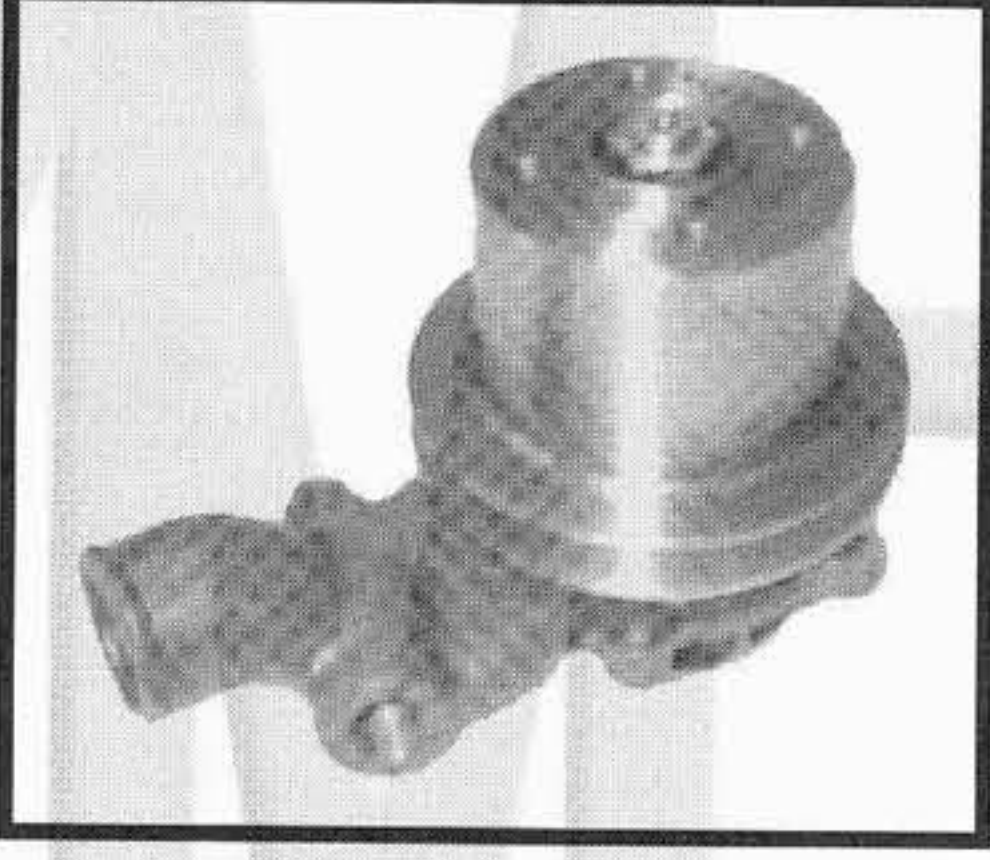
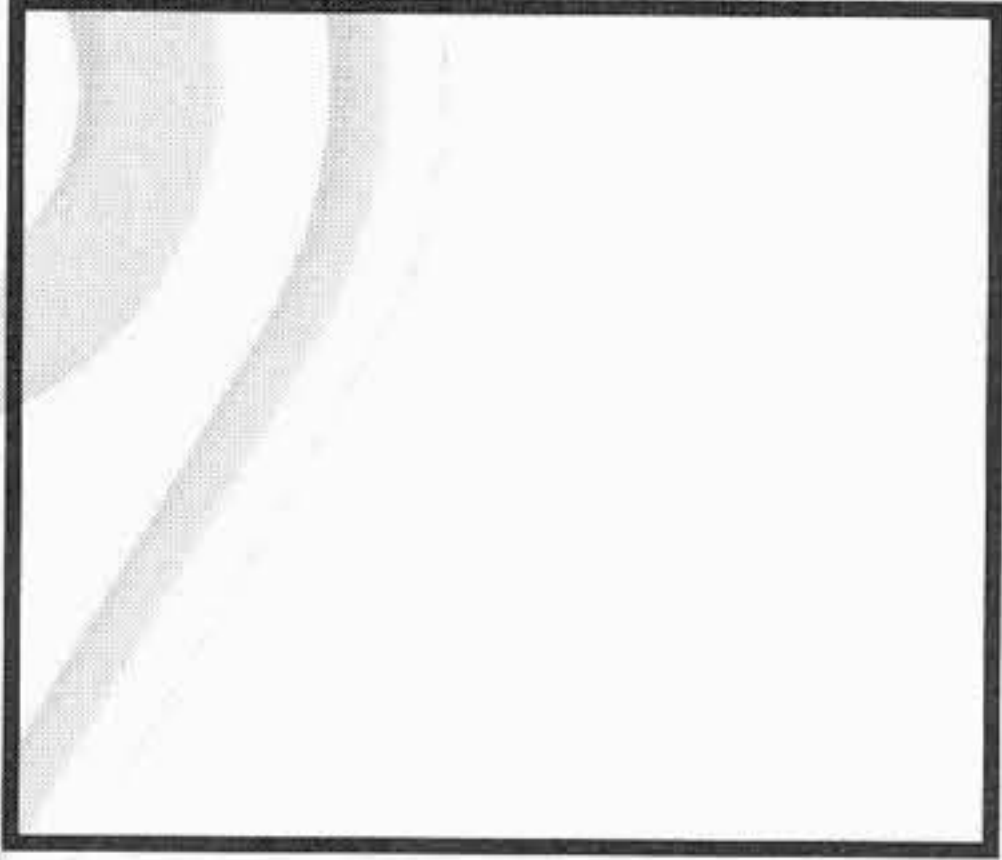

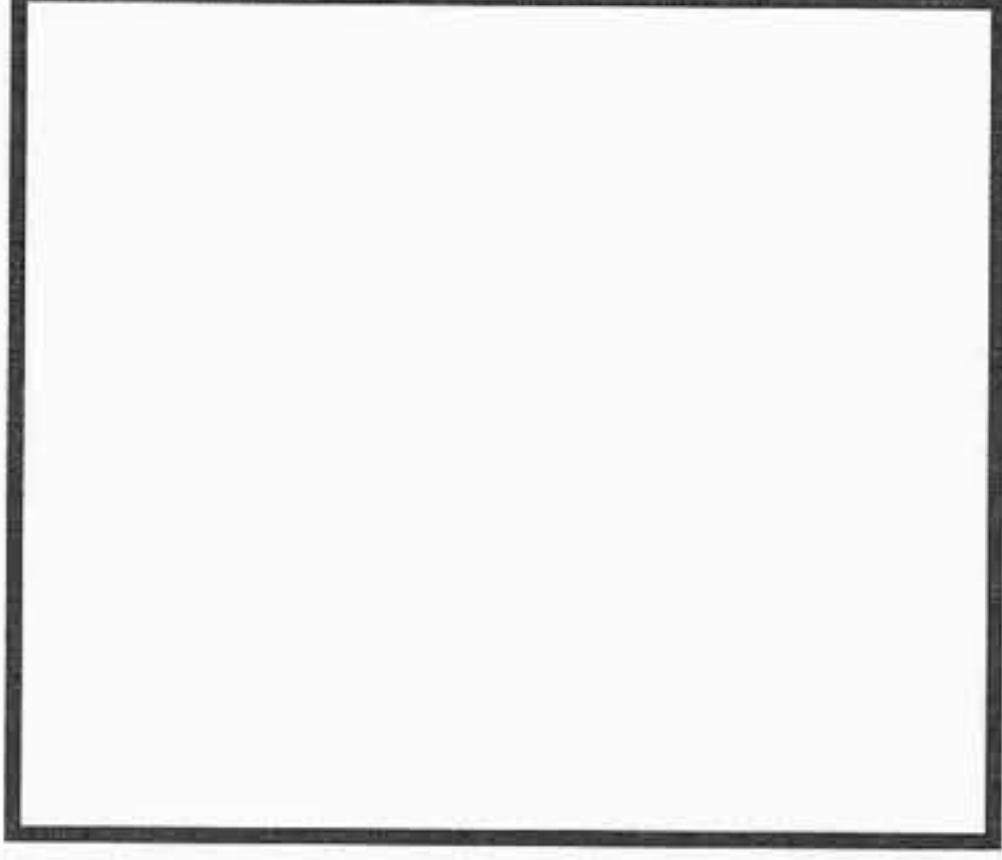
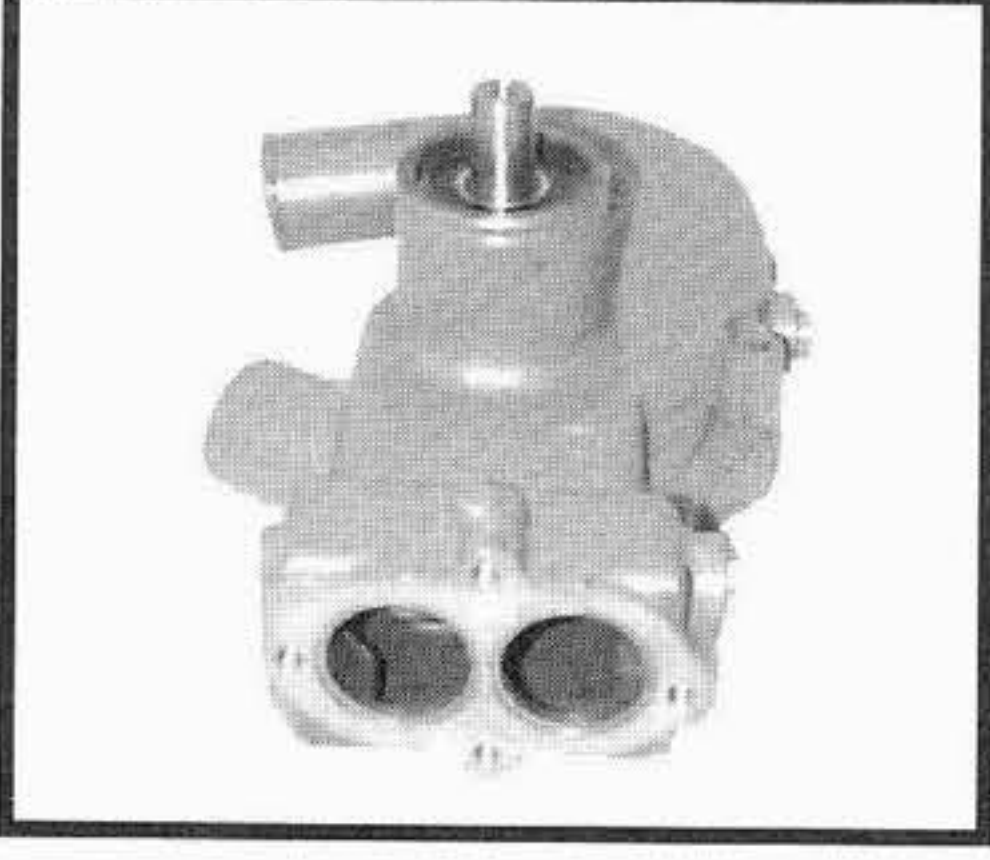
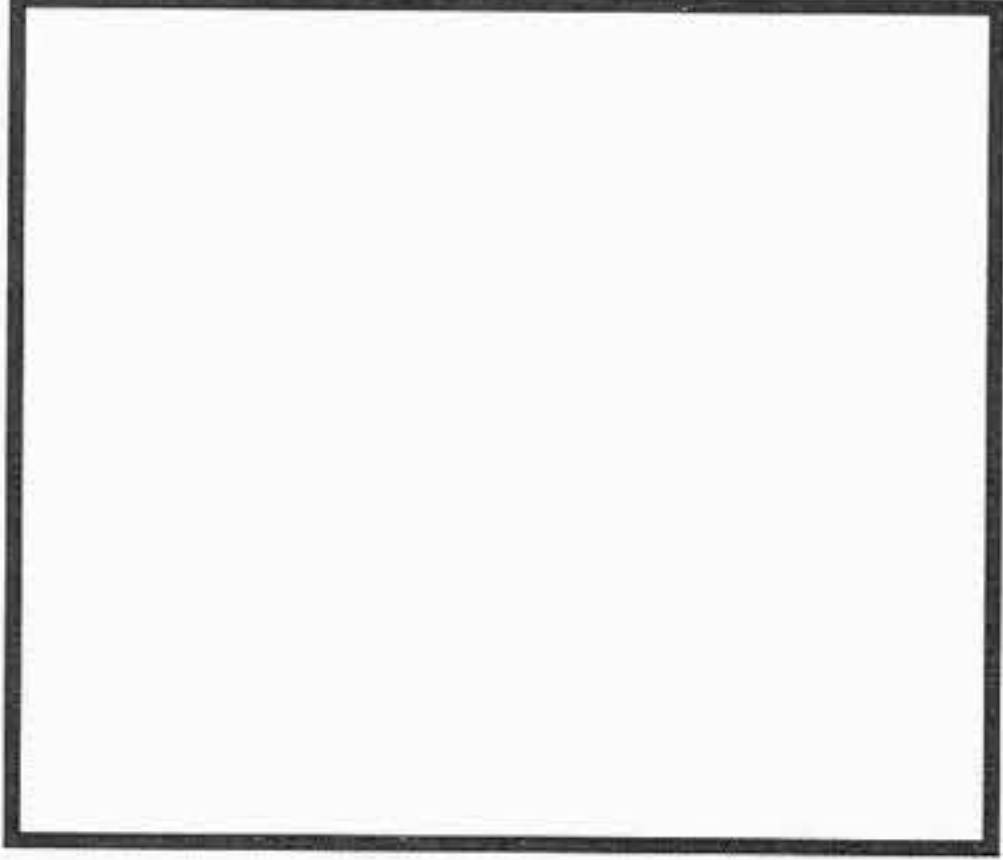
TIPO O MODELLO TYPE OU MODELE TYPE OR MODEL	MOTORE MOTEUR ENGINE	POMPA ACQUA POMPE A EAU WATER PUMP OMP REF. / O.EM. REF	KIT RIPARAZIONE NECESSAIRE DE REP. REPAIR KIT OMP REF. / O.EM. REF
TL 16 N	D4.203	<p><b>259.040</b> 41312574 CON PULEGGIA / WITH PULLEY</p>  <p><b>159.365</b> U5MW0061 SENZA PULEGGIA / WITHOUT PULLEY</p>	<p><b>152.107</b> U7LW0027</p> 
TL 20C  R 6500 R 7500 TL 20 N/A - TL 20 DT MF 174 - MF 184  R 8000  R 8500 R 65500 MF 194	4.212  4.236  A4.248  4.248	<p><b>259.450</b> 41313231P CON PULEGGIA / WITH PULLEY</p>  <p><b>159.490</b> 4131A021 SENZA PULEGGIA / WITHOUT PULLEY</p>	<p><b>152.183</b> U7LW0032</p> 
CI 8000	A4.300	<p><b>159.140</b> U5MW0014 SENZA PULEGGIA / WITHOUT PULLEY</p>  <p>--- 41312419 CON PULEGGIA / WITH PULLEY</p>	<p><b>152.155</b> U7LW0055</p> 
R 9500  MF 1104  TL 19 N/A	6.354.1	<p><b>159.230</b> U5MW0016 SENZA PULEGGIA / WITHOUT PULLEY</p> 	<p><b>252.136</b> U7LW0024</p> 

I ricambi non sono originali ma adattabili . Ogni riferimento originale é assolutamente indicativo .  
Spare parts are not original but perfectly suitable . Every original part number has to be considered for reference purpose only .





## **SECTION 34**

### **APPLICATION**

# **MASSEY FERGUSON**

## **TRACTORS**

**WATER PUMPS WASSERPUMPEN  
POMPE A EAU BOMBA DE AGUA  
POMPA ACQUA**

**S.P. WATER PUMPS LTD**  
18 Tatton Court, Kingsland Grange, Woolston,  
Warrington, Cheshire. ENGLAND. WAI 4RR  
TEL: +44(0) 1925 850082 Fax: +44(0) 1925 850083  
Email:sales@spwaterpumps.co.uk Web Site:www.spwaterpumps.co.uk

TAVOLE DI CONVERSIONE  
 TABLE DE CONVERSION  
 CONVERSION TABLE

MASSEY FERGUSON



NUMERO ORIGINALE NUMERO ORIGINAL ORIGINAL NUMBER	NUMERO SOSTITUTIVO REPLACE PAR NUMERO REPLACED BY NUMBER	RIFERIMENTO OMP REFERENCE OMP OMP REFERENCE
32346		259.066
58293	89019	
59140	89024	
68355	U7LW0008	
68364	U7LW0062	
68573	U7LW0007	
68575	U7LW0015	
68584	U7LW0020	
85707	86948	252.154
85800	U7LW0025	
85805	U7LW0003	
86948	U7LW0055	
86951	U7LW0003	
86957	U7LW0029	
89001	U7LW0022	
89007	U7LW0024	
89009	U7LW0022	
89019	U7LW0044	
89024	U7LW0027	
89030	U7LW0003	
89032		
89034	U7LW0006	
89036	U7LW0009	
0030927		259.058
0040057		259.058
0080268	0170040	251.184
0170046		259.009
0380098		259.053
0380164		259.051
0490484		259.068
0490690		259.064
0500006		251.191
0524406		259.028
0576005		259.006
0576007		259.031
0650540		259.041
0670165		259.305
0748419		259.071
0920007		251.201
0920009		259.032
0920056		259.037
0920058		251.772
0920106		251.381
0994650	3600973M91	
0994658	41312038	
2232133		259.072
2415209	2415216	

NUMERO ORIGINALE NUMERO ORIGINAL ORIGINAL NUMBER	NUMERO SOSTITUTIVO REPLACE PAR NUMERO REPLACED BY NUMBER	RIFERIMENTO OMP REFERENCE OMP OMP REFERENCE
2415213		259.136
2415216		251.042
2417204		259.141
2417208		259.022
2431154		259.041
2564406		259.028
2418M001	2418M004	
2418M004		259.428
2418M006		
2418M007		159.428
2418M011		156.206
2521D406		259.158
2721A530		251.354
31142691		259.335
31145630		259.035
31145713		259.315
31145741		259.085
31146362		259.135
31146952		259.015
31155232		259.205
32753417		259.056
32764119	3276P003	
32764124		259.078
32764127	3276P003	
3276P003		259.014
3312K011		259.156
3312K012		251.204
33143112		259.024
33143409		259.077
33157108		259.019
33157109		259.017
33157144		259.037
33415136		259.039
33811314		259.052
33813313		259.018
33814115		259.038
36866271		259.042
36866724	36866271	
36867108		259.101
36867137		259.087
37447192		259.061
37447603		259.076
37447632		259.084
37447680		259.143
37477232		259.059
37711262		259.063
37711301		259.129

OGNI RIFERIMENTO ORIGINALE E' ASSOLUTAMENTE INDICATIVO. CHAQUE REFERENCE ORIGINAL EST ABSOLUMENT INDICATIVE. EVERY ORIGINAL PART NUMBER HAS TO BE CONSIDERED FOR REFERENCE PURPOSE ONLY.

TAVOLE DI CONVERSIONE  
TABLE DE CONVERSION  
CONVERSION TABLE

MASSEY FERGUSON



NUMERO ORIGINALE NUMERO ORIGINAL ORIGINAL NUMBER	NUMERO SOSTITUTIVO REPLACE PAR NUMERO REPLACED BY NUMBER	RIFERIMENTO OMP REFERENCE OMP OMP REFERENCE
37711321		259.089
37711530		259.067
37711632		259.016
37711892		259.381
37712330		259.201
37712390		
37712470		259.291
37712540	37712541	
37712541		259.221
37712630		259.134
3771F011		159.391
41312038	41312063	
41312054	41312055	
41312055	41312494	
41312059	41312159	
41312063	41312064	
41312064	41312067	
41312067	41312165	
41312143	41312201	
41312159	41312416	
41312165	41312167	
41312167	41312266	
41312201	41312219	
41312219	41312245	
41312245	41312246	
41312246	41312248	
41312248	41312251	
41312251	41312323	
41312266	41312506	
41312323	41312325	
41312325	41312348	
41312348	41312349	
41312349	41312351	
41312351	41312354	
41312354	41312356	
41312356	41312358	
41312358	41312366	
41312366	41312379	
41312379	41312551	
41312416	41312487	
41312419	VEDI U5MW0014	
41312459		259.370
41312486	VEDI U5MW0057	
41312487		259.080
41312491	VEDI U5MW0057	
41312493	VEDI U5MW0057	
41312494	41312517	

NUMERO ORIGINALE NUMERO ORIGINAL ORIGINAL NUMBER	NUMERO SOSTITUTIVO REPLACE PAR NUMERO REPLACED BY NUMBER	RIFERIMENTO OMP REFERENCE OMP OMP REFERENCE
41312506	41312508	
41312508	41312509	
41312511	41312574	
41312517	41312544	
41312524	VEDI U5MW0057	
41312527	VEDI U5MW0057	259.310
41312544	41312784	
41312549	41312557	
41312551	41312552	
41312552	41312554	
41312554	41312561	
41312557	41312558	
41312558	41312559	
41312559	41312654	
41312561	41312562	
41312562	41312564	
41312564	41312566	
41312566	41312568	
41312568	41312689	
41312574	= 41312892	259.040
41312584	VEDI U5MW0057	
41312589	VEDI U5MW0023	
41312591	VEDI U5MW0023	
41312595	VEDI U5MW0023	
41312596	VEDI U5MW0057	
41312654	41312682	
41312663	VEDI U5MW0014	
41312681	VEDI U5MW0016	
41312682	41312698	
41312689	41312756	
41312698	41312906	
41312723	VEDI U5MW0014	
41312747	VEDI U5MW0014	
41312756	41312908	
41312768	VEDI U5MW0023	
41312783	VEDI U5MW0023	
41312784		259.050
41312785	VEDI U5MW0023	
41312786	VEDI U5MW0023	
41312806	VEDI U5MW0016	
41312807	VEDI U5MW0016	
41312808	VEDI U5MW0016	
41312809	VEDI U5MW0016	
41312811	VEDI U5MW0037	
41312828	VEDI U5MW0014	
41312892	= 41312574	
41312906	41312907	

OGNI RIFERIMENTO ORIGINALE E' ASSOLUTAMENTE INDICATIVO. CHAQUE REFERENCE ORIGINAL EST ABSOLUMENT INDICATIVE. EVERY ORIGINAL PART NUMBER HAS TO BE CONSIDERED FOR REFERENCE PURPOSE ONLY.

TAVOLE DI CONVERSIONE  
TABLE DE CONVERSION  
CONVERSION TABLE

MASSEY FERGUSON



NUMERO ORIGINALE NUMERO ORIGINAL ORIGINAL NUMBER	NUMERO SOSTITUTIVO REPLACE PAR NUMERO REPLACED BY NUMBER	RIFERIMENTO OMP REFERENCE OMP OMP REFERENCE
41312907	41313018	
41312911	41312913	
41312913	41312915	
41312915	41312918	
41312918	41313201	
41313018	41313045	
41313027		159.355
41313033	41313047	
41313045		159.090
41313047	= 41313049	159.260
41313058	= 41313027	
41313065	= 41313047	
41313068	= 41313045	
41313075	= U5MW0016	
41313085	= U5MW0019	
41313086	= 41313038	
41313201	41313225	
41313209	41313218	
41313211	41313226	
41313212	41313228	259.380
41313218	41313227	159.150
41313225	41313231	
41313226	41313233	
41313227	41313237	
41313228		159.380
41313231	4131A013	159.450
41313232	4131A021	159.460
41313233		159.350
41313237		159.470
41313256	= 41313226	
41313261	= 41313237	
41313269	= U5MW0014	
41313402	= U5MW0057	
41313403	= U5MW0023	
41313801	41313812	
41313812		
4131A013	4131A021	
4131A021	4131A029	
4131A029	4131A034	
4131A034		159.490
4131E002	4131E005	
4131E005	4131E007	
4131E007	4131E011	
4131E011		159.500
4131E012		159.510
4131E105	4131E011	
U5MW0006	U5MW0057	

NUMERO ORIGINALE NUMERO ORIGINAL ORIGINAL NUMBER	NUMERO SOSTITUTIVO REPLACE PAR NUMERO REPLACED BY NUMBER	RIFERIMENTO OMP REFERENCE OMP OMP REFERENCE
U5MW0010	U5MW0055	
U5MW0014		159.140
U5MW0016		159.230
U5MW0023		159.310
U5MW0037		
U5MW0041	U5MW0054	
U5MW0044		159.360
U5MW0054		159.370
U5MW0055	U5MW0061	
U5MW0056	U5MW0062	
U5MW0057		159.375
U5MW0061		159.365
U5MW0062		159.475
U5MW0088	= U5MW0062	
U5MW0089	= U5MW0061	
U5MW0092	= 4131E011	
U5MW0096	= U5MW0057	
U5MW0097	= U5MW0023	
U5MW0104	= 4131A034	
U5MW0106	= 41313228	
U5MW0108	= 41313237	
U5MW0111	= 41313045	
U5MW0133	= 41313027	
U5MW0144	= 41313027	
U5MW0147	= U5MW0014	
U7 LW0002	U7 LW0030	
U7 LW0003		252.175
U7 LW0006	U7 LW0029	
U7 LW0007	U7 LW0002	
U7 LW0008	U7LW0031	
U7 LW0009		152.097
U7 LW0015		152.153
U7 LW0020		252.243
U7 LW0022		152.156
U7 LW0024		252.136
U7 LW0025		152.112
U7 LW0027		152.107
U7 LW0029	U7LW0032	
U7 LW0030		152.255
U7L W0031		152.256
U7 LW0032	U7L W0058	
U7 LW0034	U7 LW0071	
U7 LW0044		152.130
U7 LW0047		152.259
U7 LW0055		152.155
U7L W0058		152.183
U7 LW0062		

OGNI RIFERIMENTO ORIGINALE E' ASSOLUTAMENTE INDICATIVO. CHAQUE REFERENCE ORIGINAL EST ABSOLUMENT INDICATIVE. EVERY ORIGINAL PART NUMBER HAS TO BE CONSIDERED FOR REFERENCE PURPOSE ONLY.







SUITABLE

# MASSEY FERGUSON

Tel: +44(0)1925 850082 Fax: +(0)44 1925 850083

www.spwaterpumps.co.uk

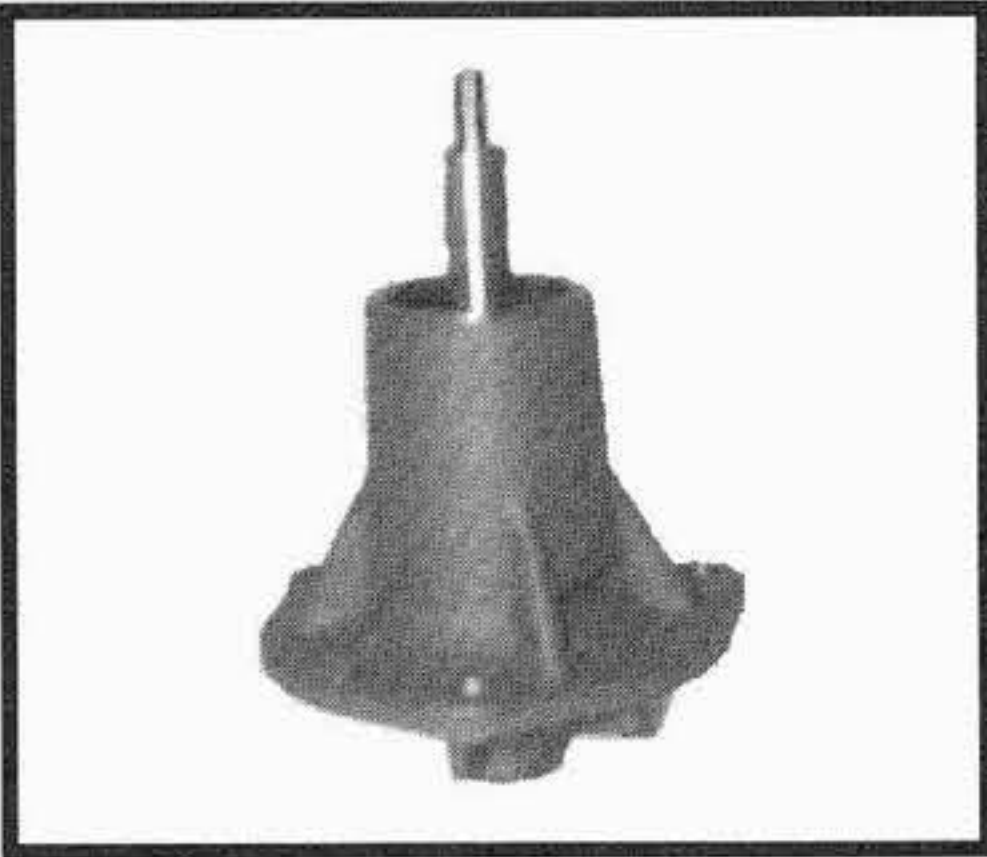
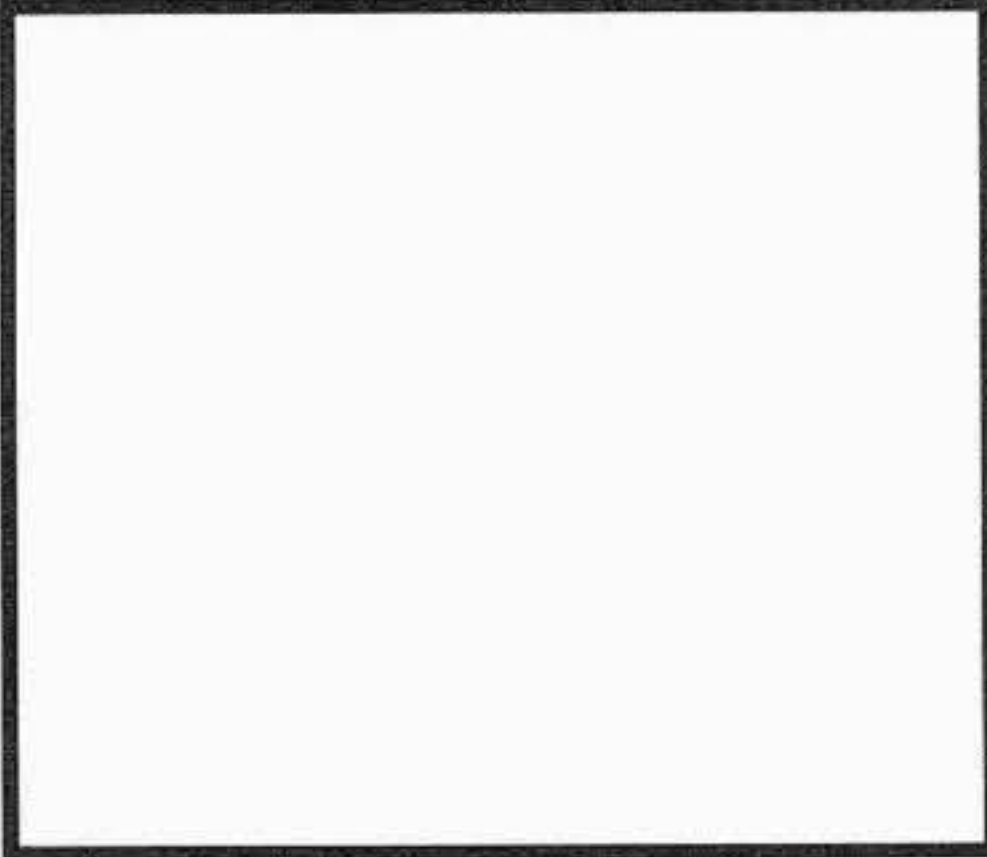

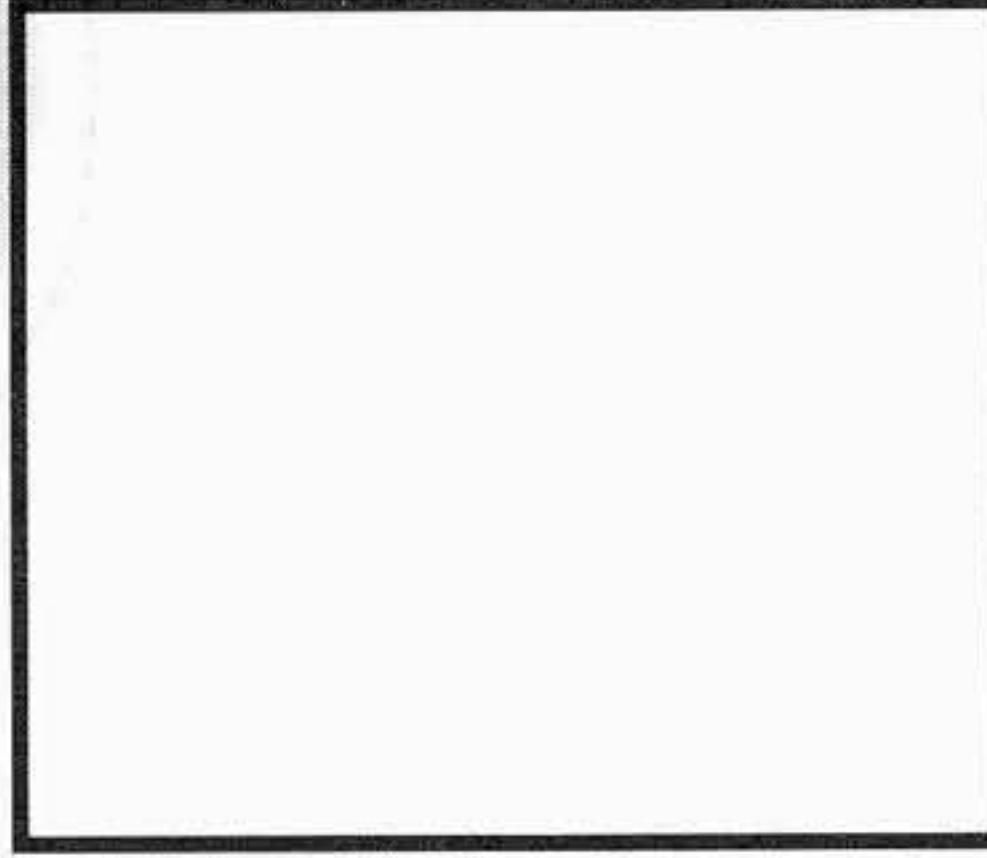
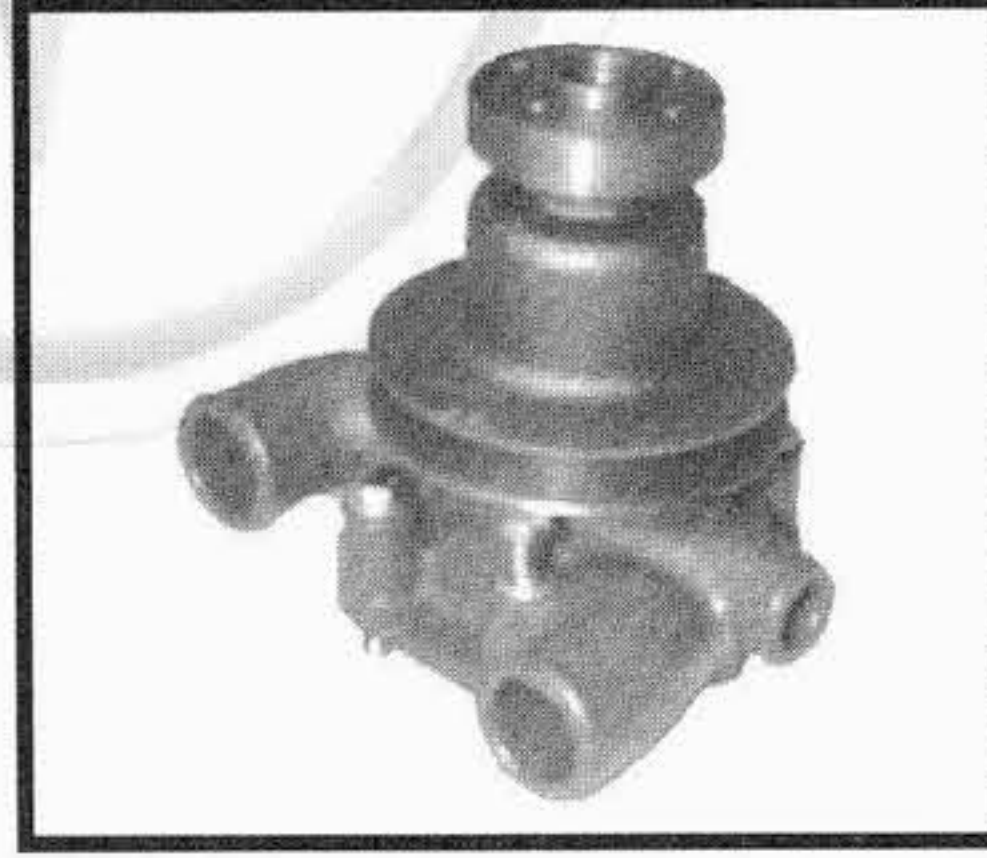
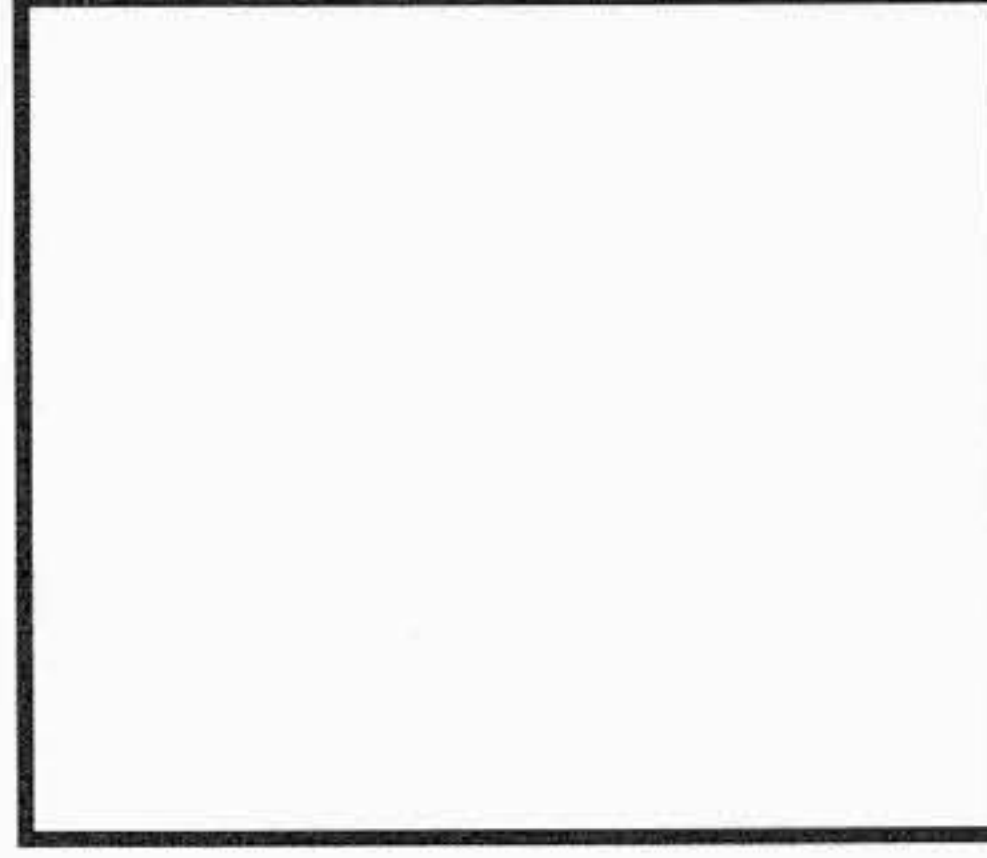
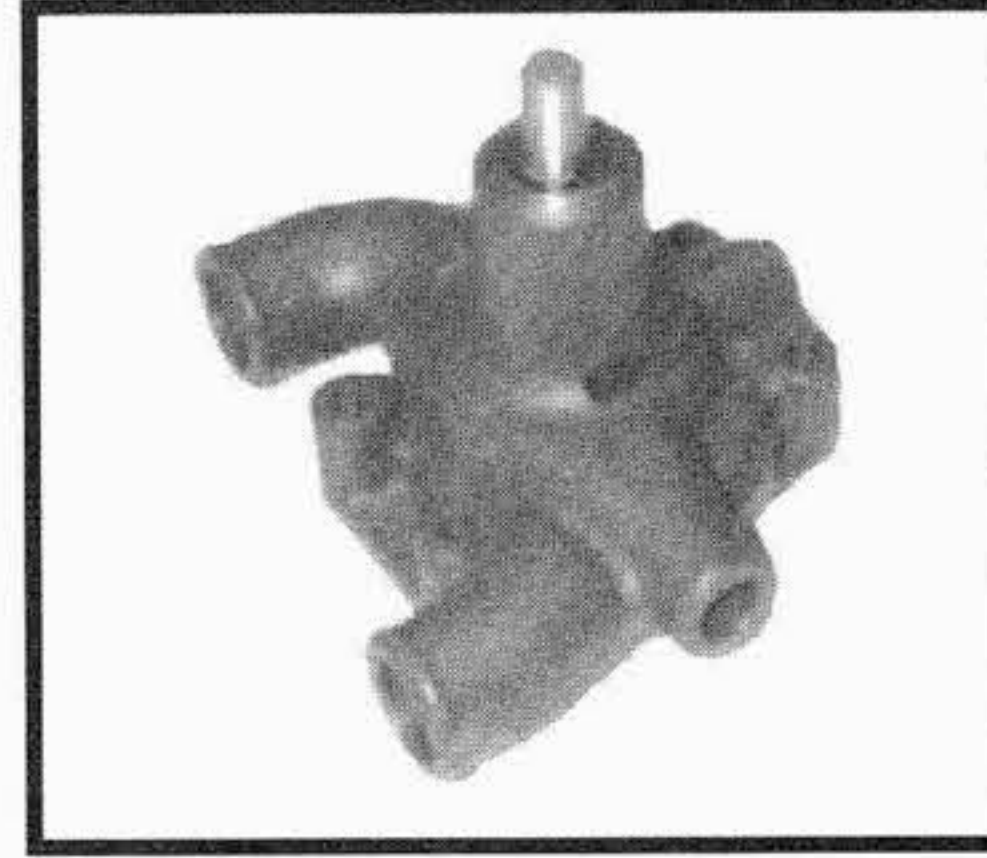
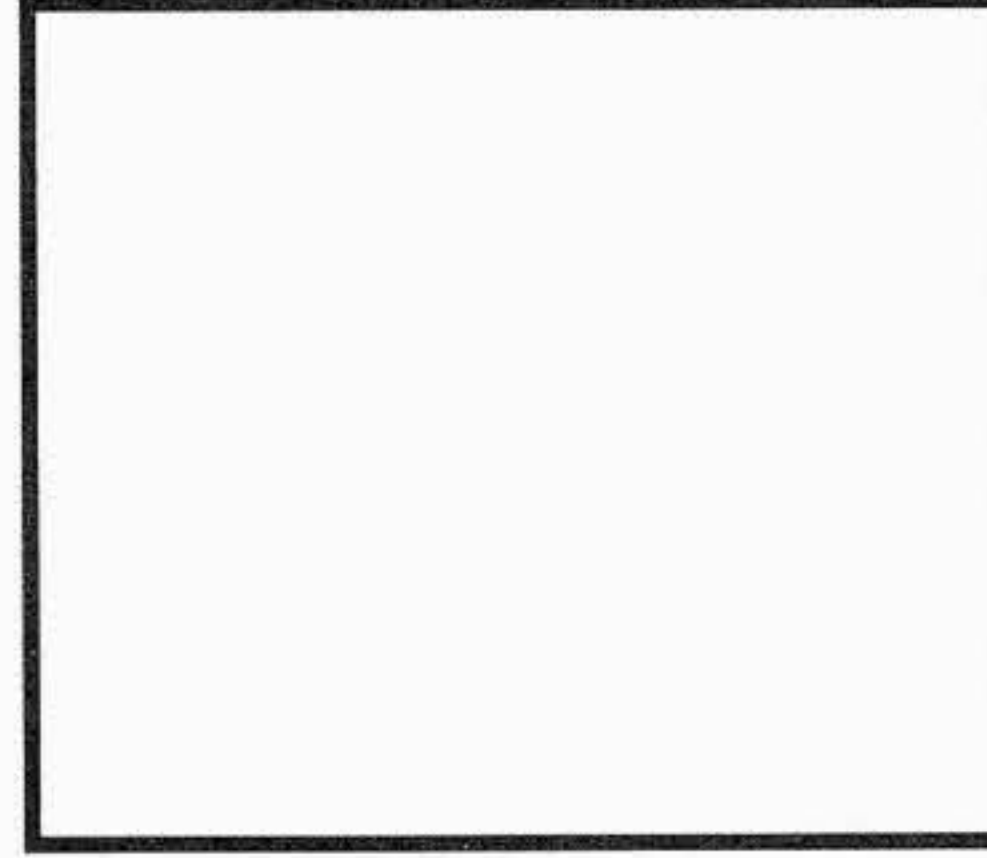
TIPO O MODELLO TYPE OU MODELE TYPE OR MODEL	MOTORE MOTEUR ENGINE	POMPA ACQUA POMPE A EAU WATER PUMP	KIT RIPARAZIONE NECESSAIRE DE REP. REPAIR KIT
MF TE20 C  FE 35      1957 / 64  MF 135  MF 702      1957 / 64	LO petrol  VO diesel  TE 20	<p><b>159.120</b>    1885489M91                      SENZA MOZZO / WITHOUT HUB</p>  <p><b>159.130</b>    3600973M91                      CON MOZZO / WITH HUB</p>	<p>---                      ---</p> 
MF 20 MF 35 - DX 35 - DX 65 MF 100 C MF 133 - DX 133 - MF 134 C MF 135 <b>152UA5275D 1969 ---&gt;</b> MF 145 - MF 147 MF 148      1970 / 77 MF 150 - MF 150C - MF 154C <b>1969 -&gt;</b> MF 230 - MF 235 - MF 255 MF 245 - MF 250 - MF 254 MF 247 MF 550 <b>1975 ---&gt;</b> MF 644 MF 2135 - MF 2500 - MF 450	A3.152  D3.152 A3.152 - AD3.152 A3.152 AD3.152 AD3.152 A3.152-AD3.152 A3.152 A3.152 - AD3.152 A3.152 AD3.152 S A3.152 AD3.152	<p><b>259.080</b>    41312487                      CON PULEGGIA / WITH PULLEY</p>  <p><b>159.310</b>    U5MW0023                      SENZA PULEGGIA / WITHOUT PULLEY</p>	<p><b>152.130</b>    U7LW0044</p> 
MF 20 - MF 20 B - MF 20 C MF 30 B - MF 30 E DX 35 MF 35 <b>1959 / 64</b> MF 40 MF 50 <b>1959 / 64</b> MF 135 <b>152UA5274D 1964/69</b> MF 150 - MF 165 <b>1965 / 69</b> MF 200 C MF 203 - MF 205 <b>1964/69</b> MF 240 - MF 244 - MF 248 S MF 356 MF 550 MF 911 MF 2135 <b>1965/69</b> MF 2203 - MF 2205 - MF 2345 MF 4000	D3.152 3.152 - D3.152 D3.152 A3.152 AD3.152 A3.152 AD3.152 AD3.152 D3.152 A3.152 D3.152 3.152 AD3.152 D3.152 AD3.152 AD3.152 AD3.152	<p><b>259.050</b>    41312784                      CON PULEGGIA / WITH PULLEY</p>  <p><b>159.310</b>    U5MW0023                      SENZA PULEGGIA / WITHOUT PULLEY</p>	<p><b>152.130</b>    U7LW0044</p> 
MF 244	3.152	<p><b>159.310</b>    U5MW0023                      SENZA PULEGGIA / WITHOUT PULLEY</p>  <p>---                      41312536                      CON PULEGGIA / WITH PULLEY</p>	<p><b>152.130</b>    U7LW0044</p> 

I ricambi non sono originali ma adattabili . Ogni riferimento originale é assolutamente indicativo .  
 Spare parts are not original but perfectly suitable . Every original part number has to be considered for reference purpose only .

SUITABLE

# MASSEY FERGUSON

Tel: +44(0)1925 850082 Fax: +(0)44 1925 850083

www.spwaterpumps.co.uk

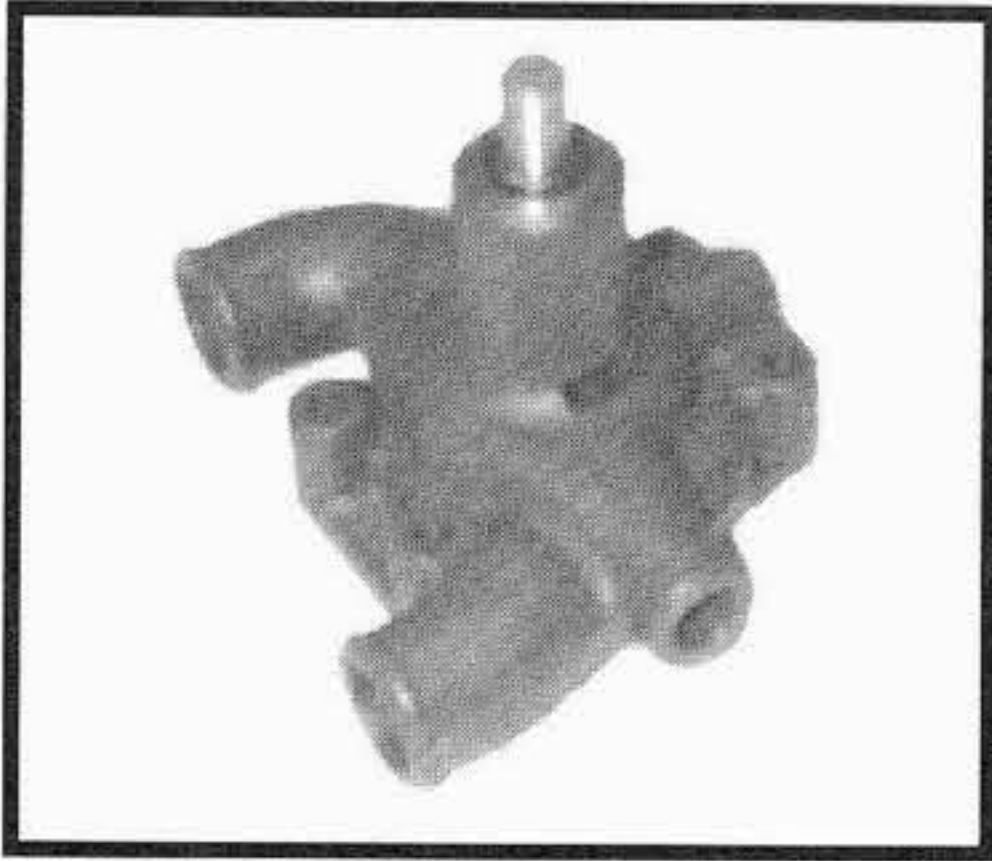
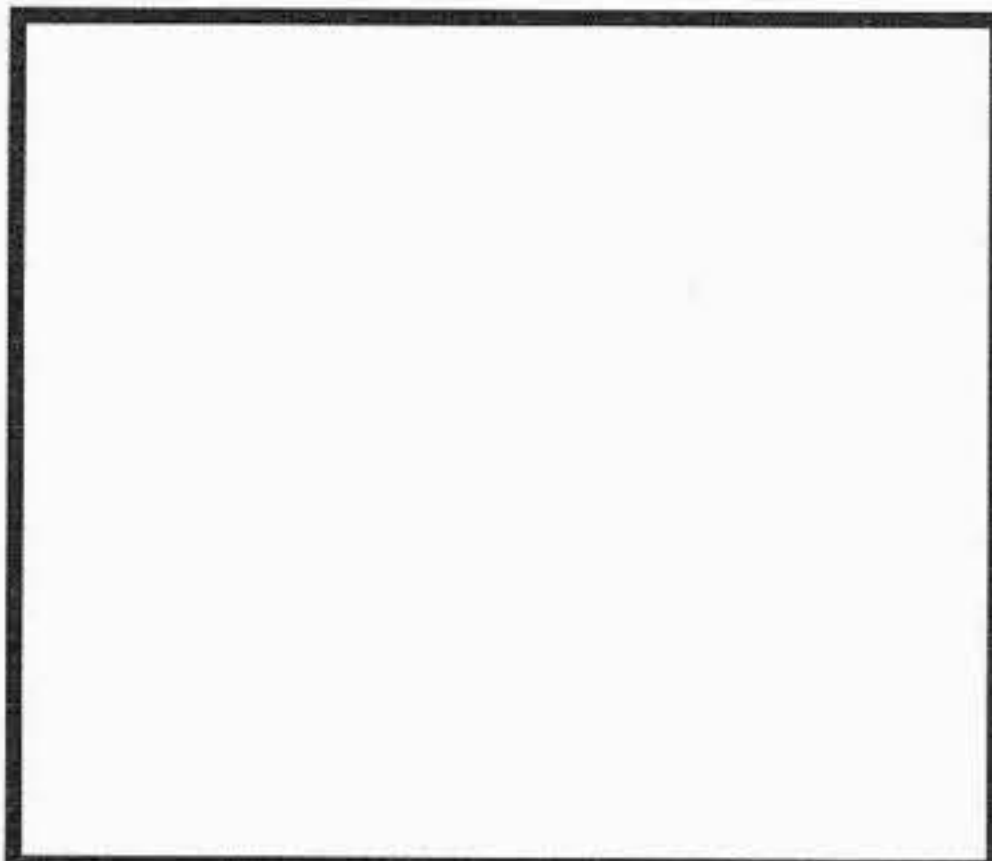
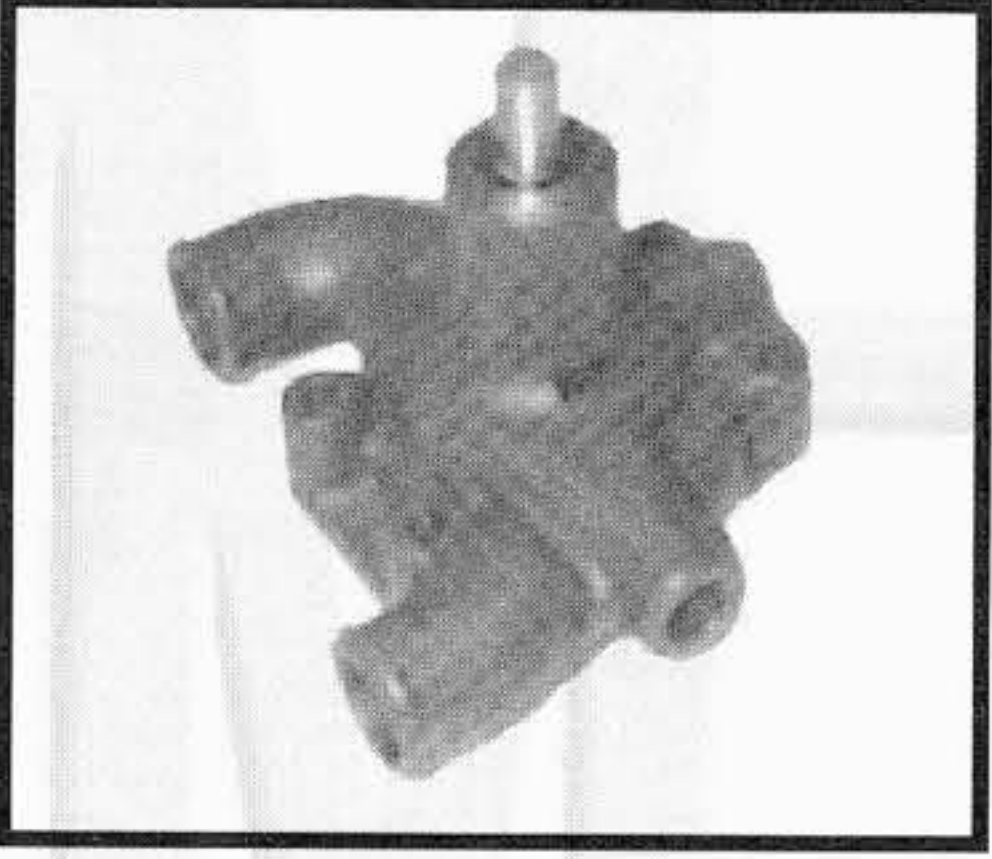
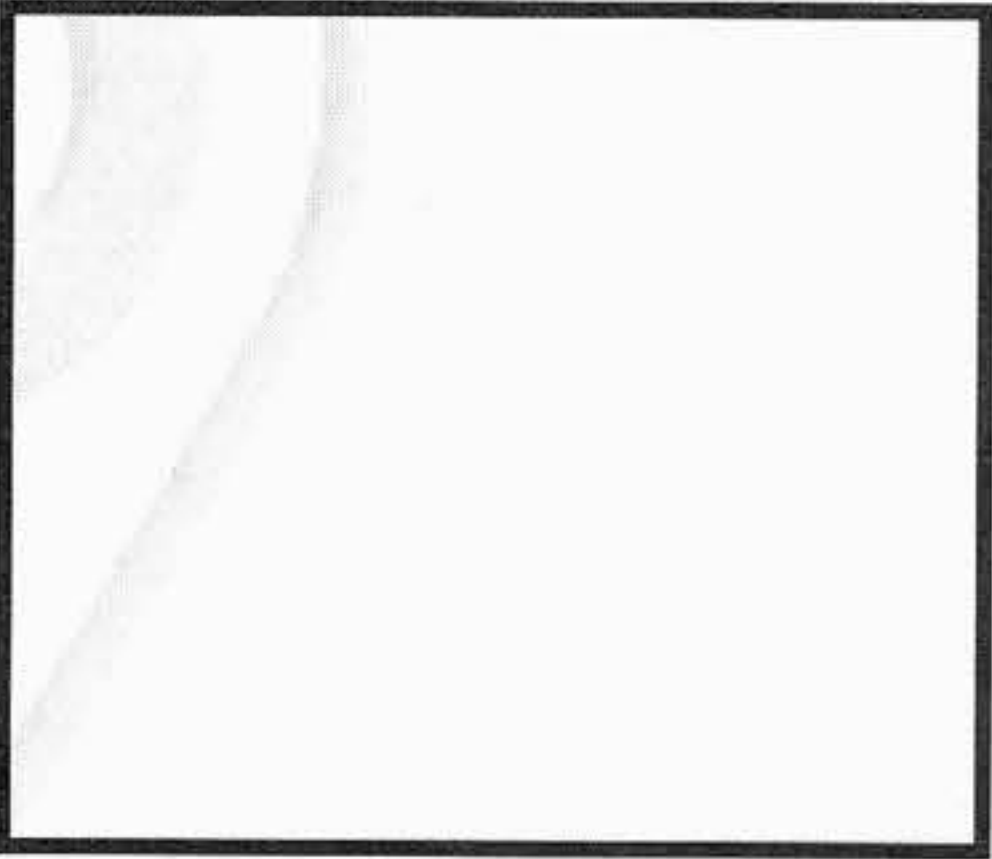
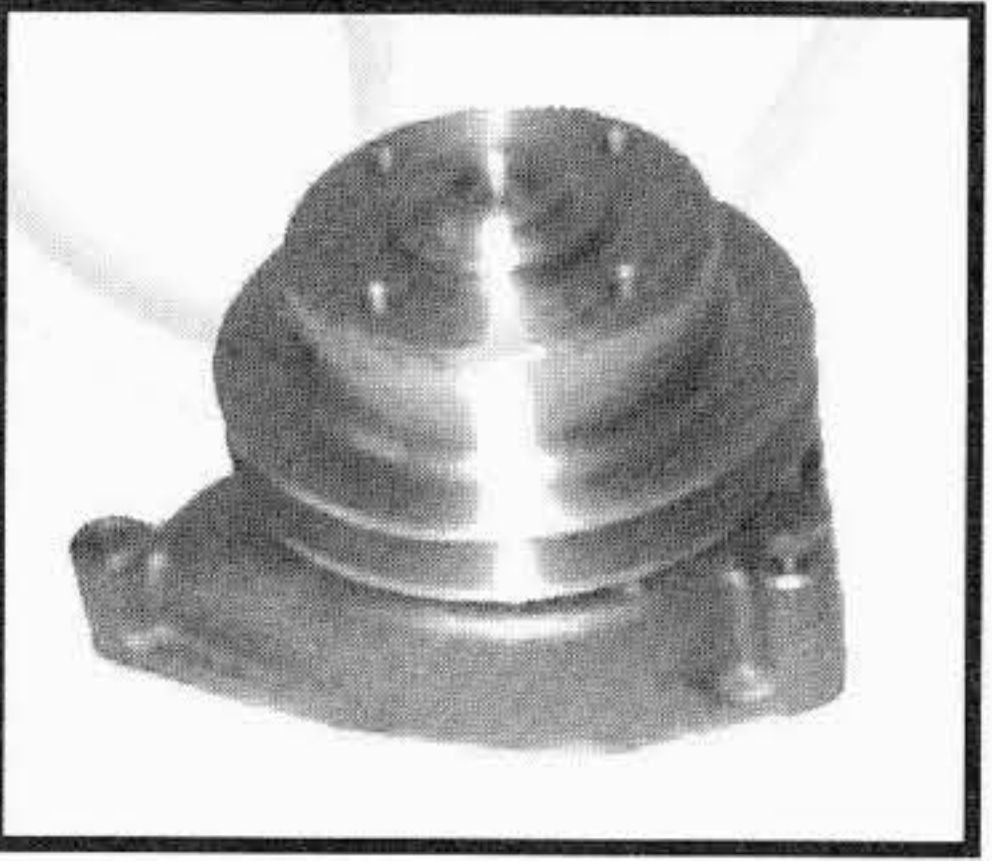
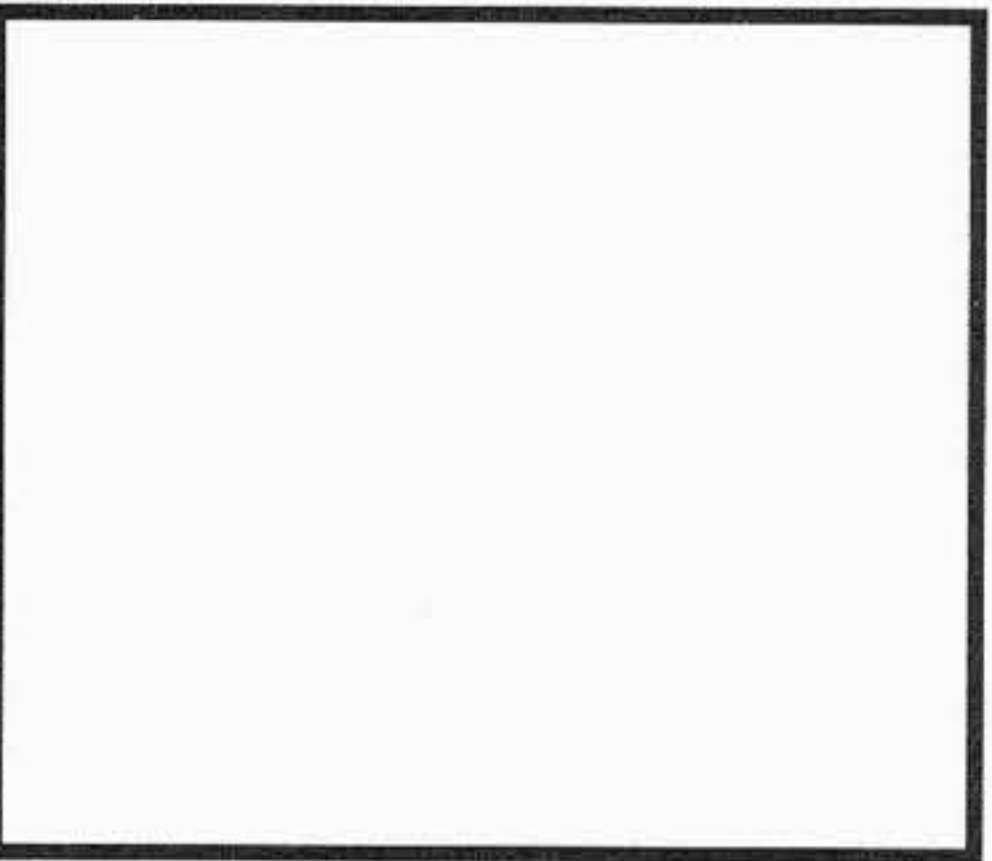
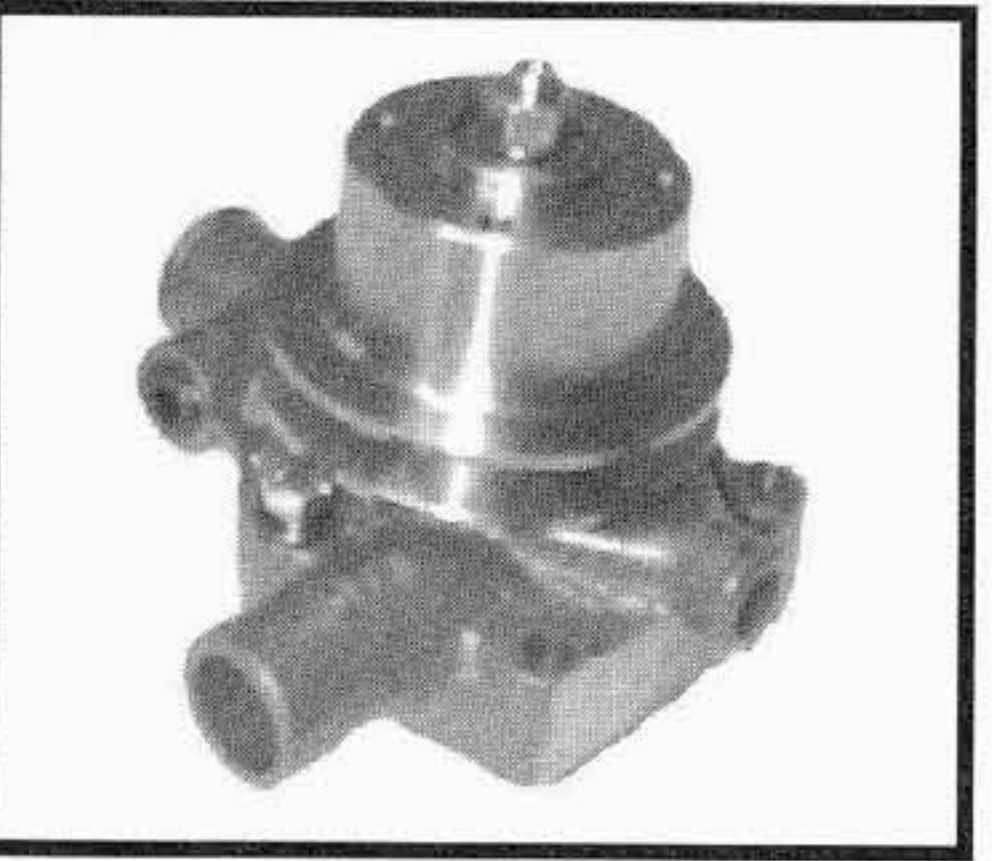
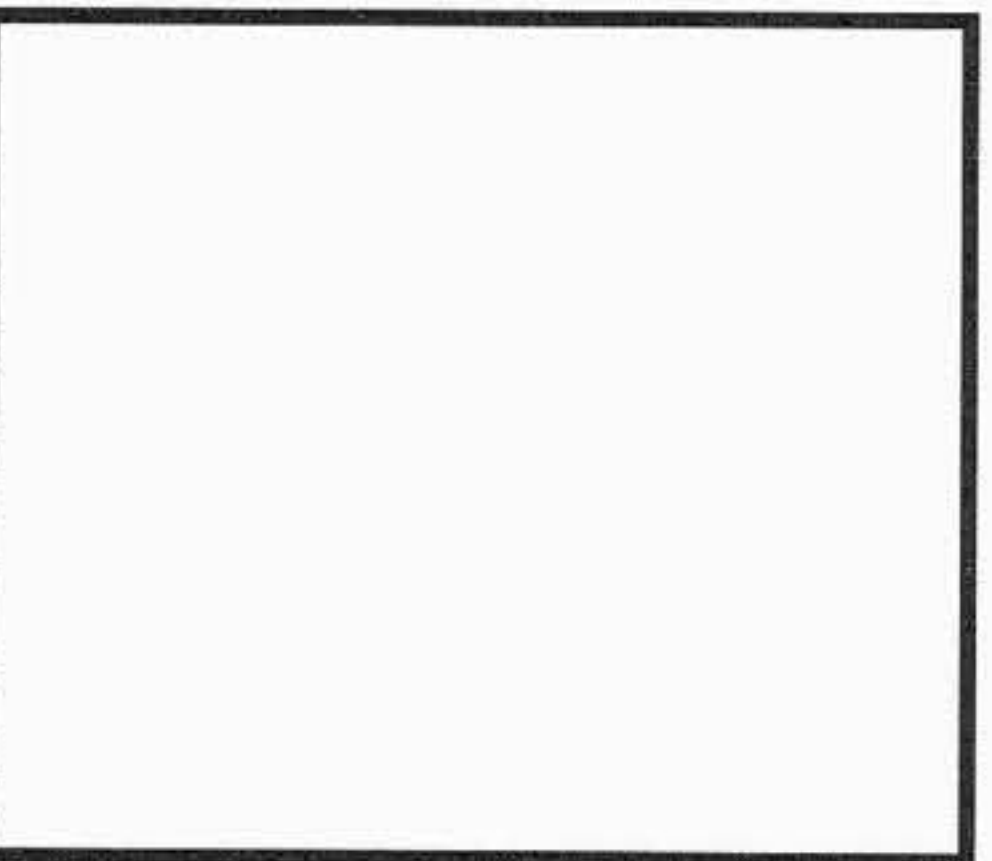

TIPO O MODELLO TYPE OU MODELE TYPE OR MODEL	MOTORE MOTEUR ENGINE	POMPA ACQUA POMPE A EAU WATER PUMP	KIT RIPARAZIONE NECESSAIRE DE REP. REPAIR KIT
MF 200	AD3.152	<p><b>159.310</b> U5MW0023 SENZA PULEGGIA / WITHOUT PULLEY</p>  <p>--- 41312595 CON PULEGGIA / WITH PULLEY</p>	<p><b>152.130</b> U7LW0044</p> 
MF 911	AD3.152	<p><b>159.310</b> U5MW0023 SENZA PULEGGIA / WITHOUT PULLEY</p>  <p>--- 41312591 CON PULEGGIA / WITH PULLEY</p>	<p><b>152.130</b> U7LW0044</p> 
MF 25 C MF 86.6 MF 130 MF 630 MF NX 730	4.107  4.99 - 4.107  4.107 - 4.108  4.108	<p><b>259.370</b> 41312459 CON PULEGGIA / WITH PULLEY</p>  <p><b>159.370</b> U5MW0054 SENZA PULEGGIA / WITHOUT PULLEY</p>	<p><b>252.175</b> U7LW0003</p> 
MF 30 MF 40 B MF 65 <b>1957 / 64</b> MF 155 - MF 158 MF 165 <b>1964 / 70</b> MF 260 - MF 265 MF 300 Combine - MF 304 MF 560 MF 765 <b>1964 / 70</b>	D4.203  A4.192 - A4.203  D4.203  A4.192 - A4.203  D4.203  D4.203  A4.192 - A4.203	<p><b>259.040</b> 41312574 CON PULEGGIA / WITH PULLEY</p>  <p><b>159.365</b> U5MW0061 SENZA PULEGGIA / WITHOUT PULLEY</p>	<p><b>152.107</b> U7LW0027</p> 

I ricambi non sono originali ma adattabili . Ogni riferimento originale é assolutamente indicativo .  
Spare parts are not original but perfectly suitable . Every original part number has to be considered for reference purpose only .

SUITABLE

# MASSEY FERGUSON

Tel: +44(0)1925 850082 Fax: +(0)44 1925 850083

www.spwaterpumps.co.uk

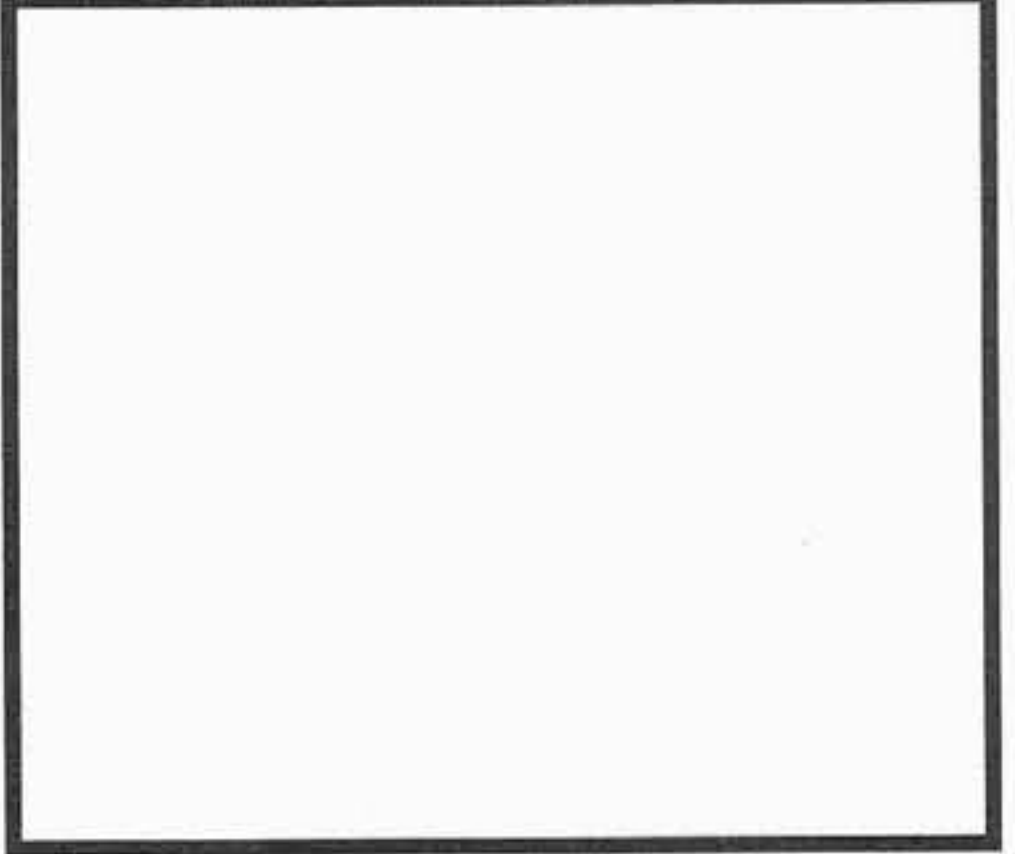
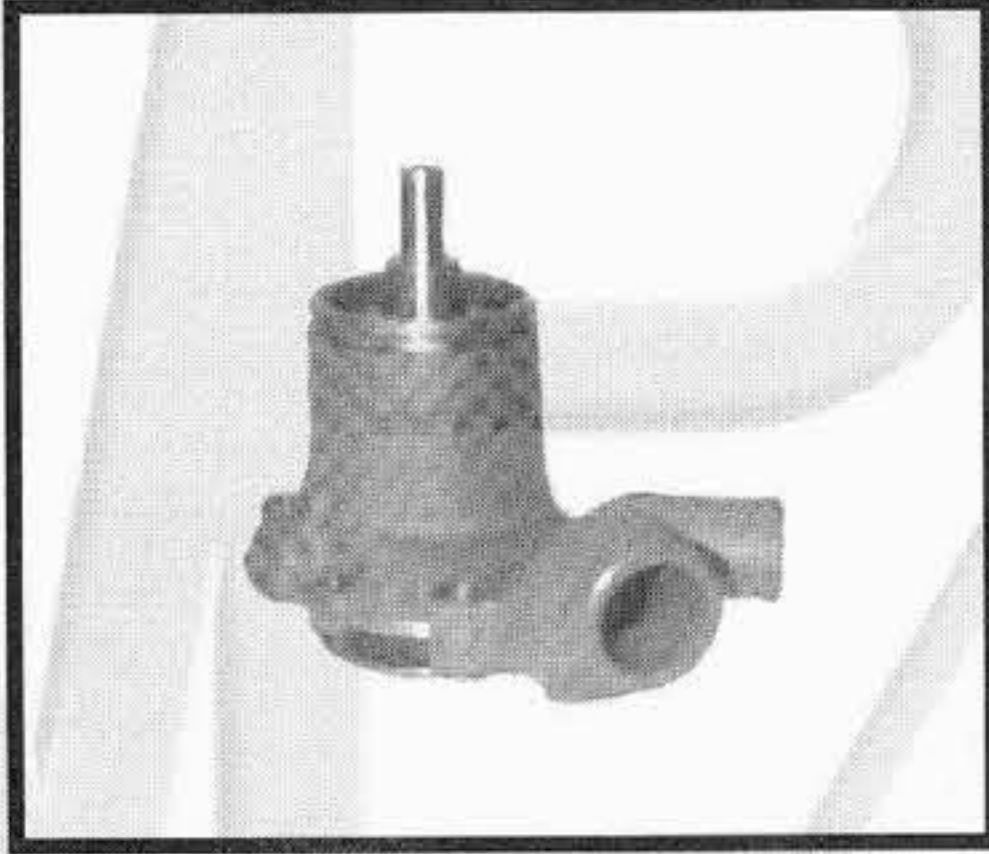
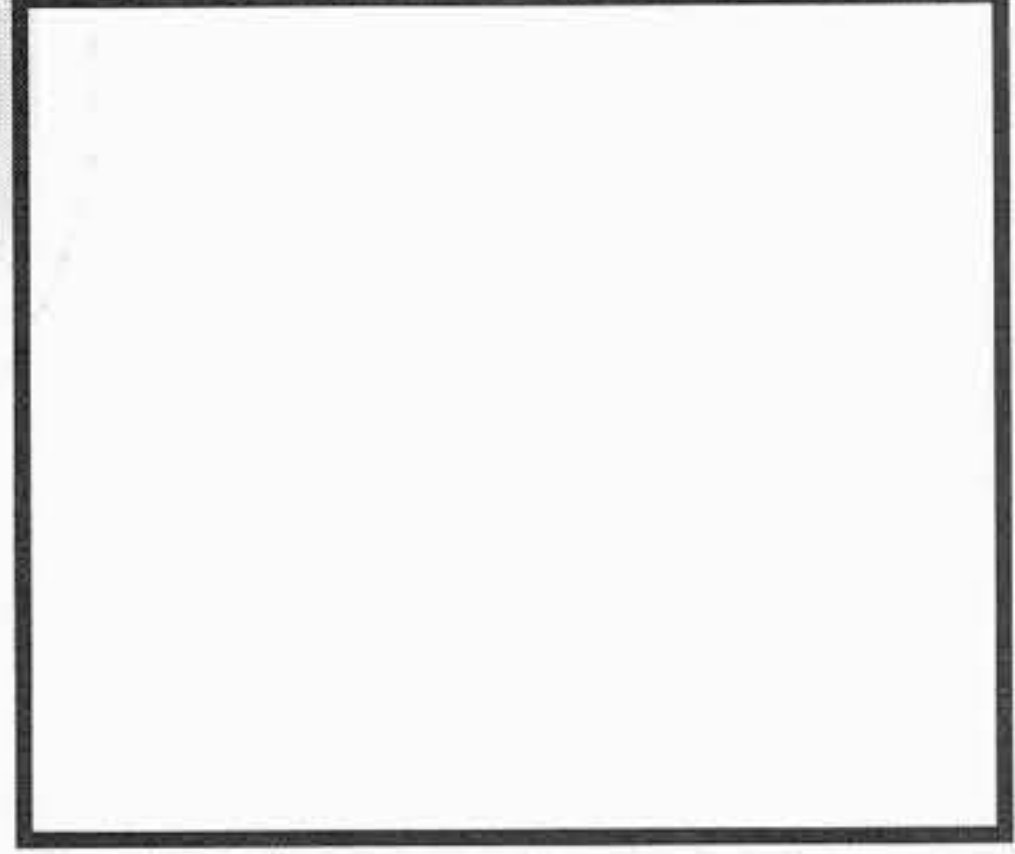
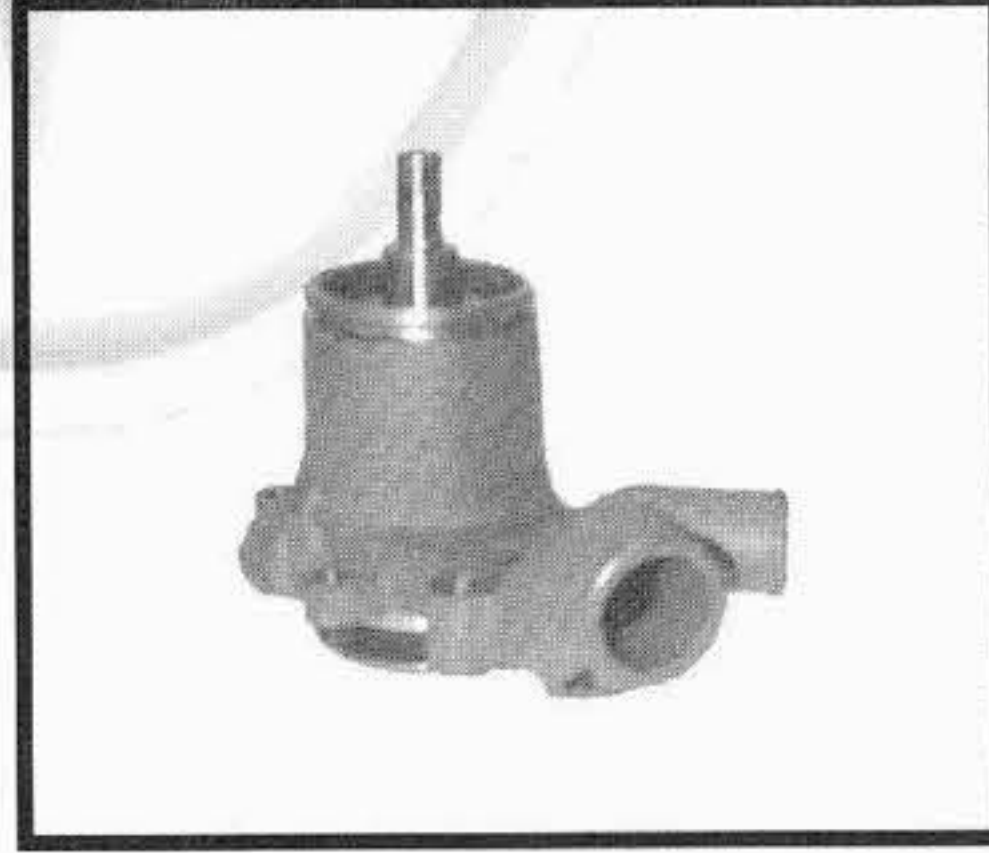
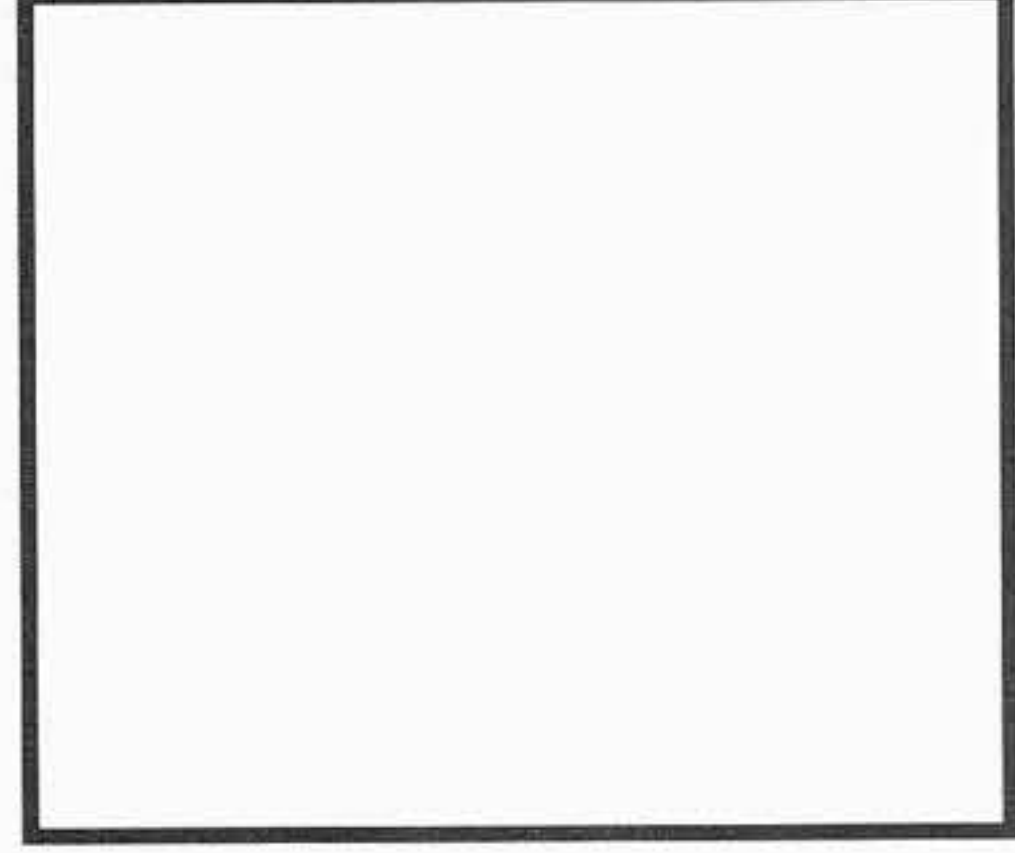
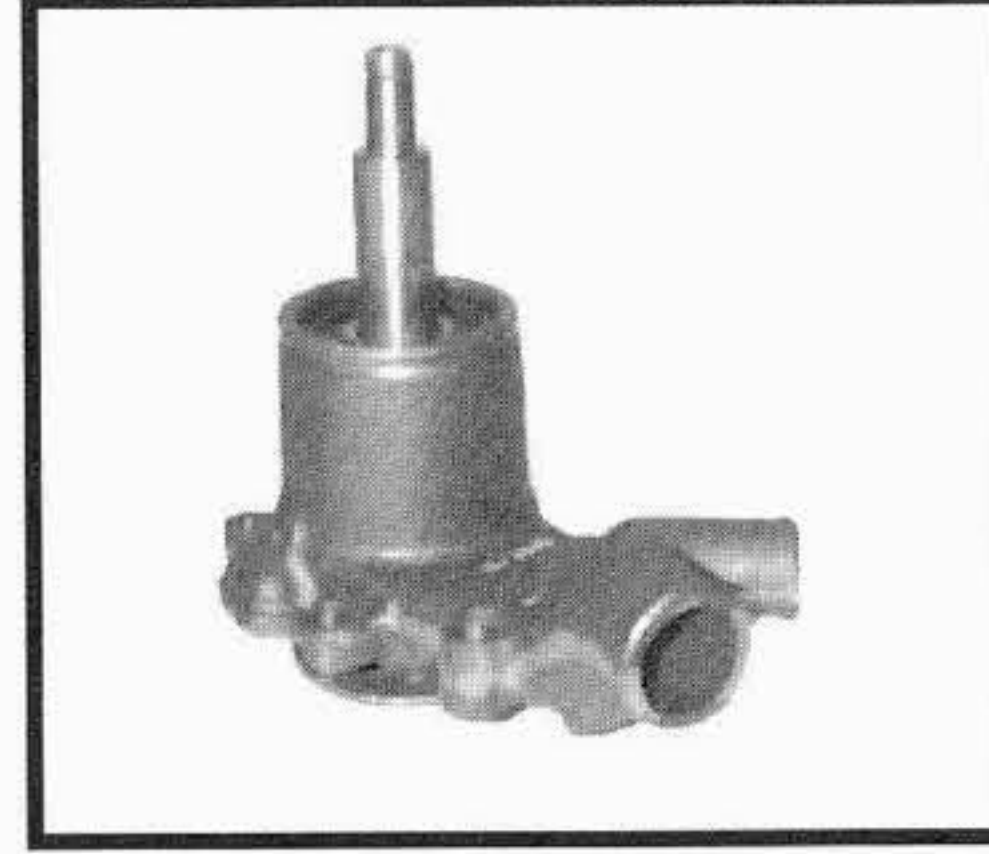
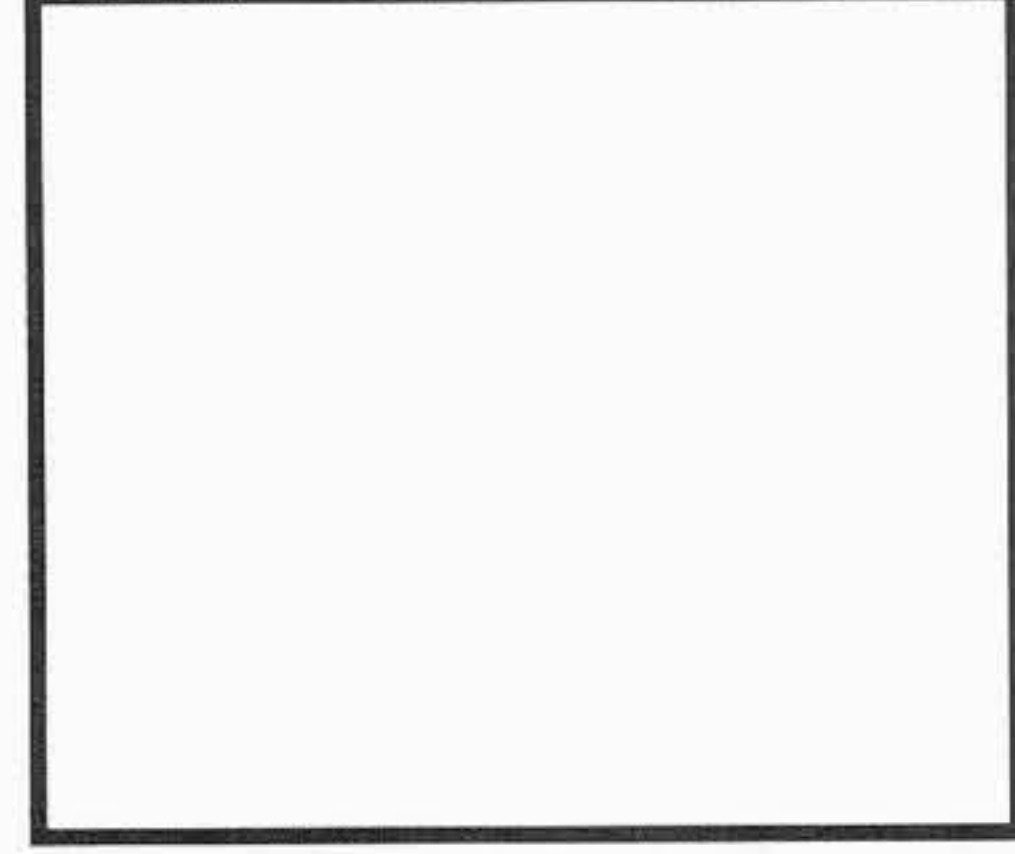

TIPO O MODELLO TYPE OU MODELE TYPE OR MODEL	MOTORE MOTEUR ENGINE	POMPA ACQUA POMPE A EAU WATER PUMP OMP REF. / O.EM. REF	KIT RIPARAZIONE NECESSAIRE DE REP. REPAIR KIT OMP REF. / O.EM. REF
MF 165	D4.203 - A4.203	<p><b>159.475</b> U5MW0062 SENZA PULEGGIA / WITHOUT PULLEY</p> 	<p><b>152.259</b> U7LW0047</p> 
MF 11 MF 33 MF 250 MF 300 II° TIPO MF 330 MF 350	A4.248	<p><b>159.150</b> 41313218 SENZA PULEGGIA / WITHOUT PULLEY</p>  <p>ad esaurimento sost. da / will be supersided by <b>159.470</b> 41313237</p>	<p><b>152.255</b> U7LW0059</p> 
MF 11 MF 33 MF 250 - MF 300 II° TIPO MF 330 - MF 350 - MF 375 W 350 MF 390 - MF 390 T - MF 396 T MF 398 - MF 1007 MF 698 T MF 3050 - MF 3060 MF 3065 - MF 3070	A4.248     4.248  AT4.236  T4.236  A4.236  AT4.236	<p><b>159.470</b> 41313237 SENZA PULEGGIA / WITHOUT PULLEY</p>  <p>ALBERO / SHAFT L = 159 MM</p>	<p><b>152.255</b> U7LW0059</p> 
MF 22 C          MF 220	4.248	<p><b>159.350</b> 41313233 SENZA PULEGGIA / WITHOUT PULLEY</p>  <p>ALBERO / SHAFT L = 198,65 MM</p>	<p><b>152.256</b> U7LW0031</p> 

I ricambi non sono originali ma adattabili . Ogni riferimento originale é assolutamente indicativo .  
Spare parts are not original but perfectly suitable . Every original part number has to be considered for reference purpose only .

SUITABLE

# MASSEY FERGUSON

Tel: +44(0)1925 850082 Fax: +(0)44 1925 850083

www.spwaterpumps.co.uk

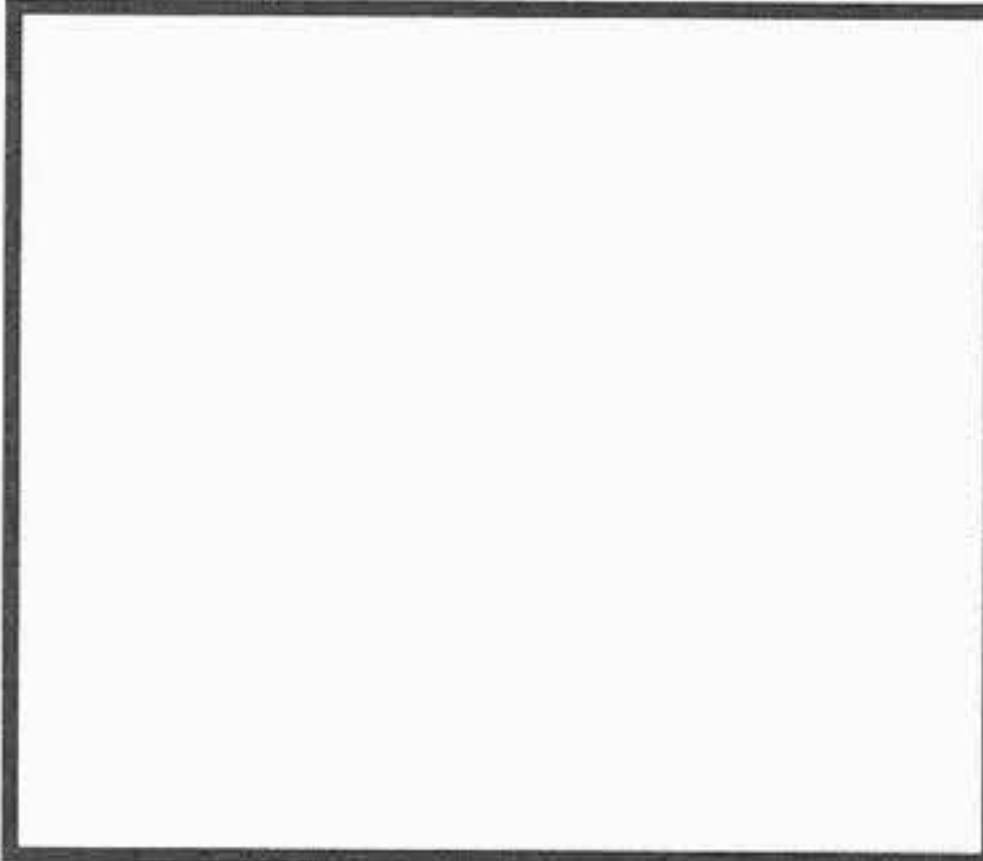
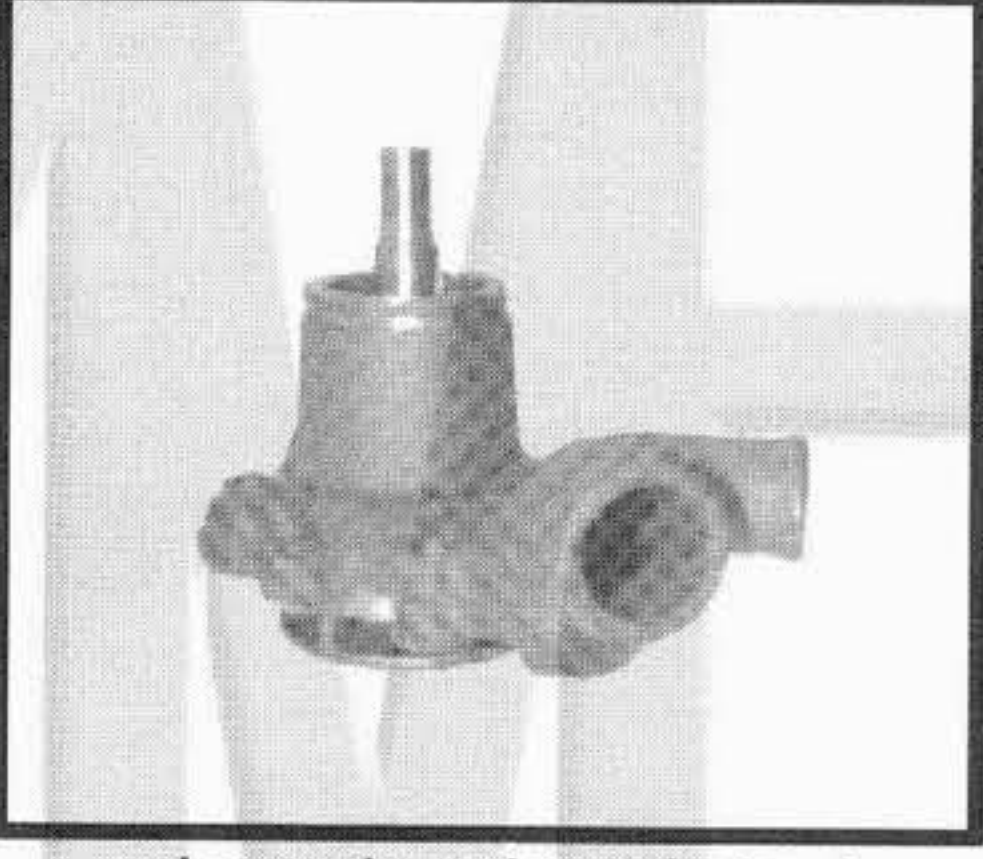
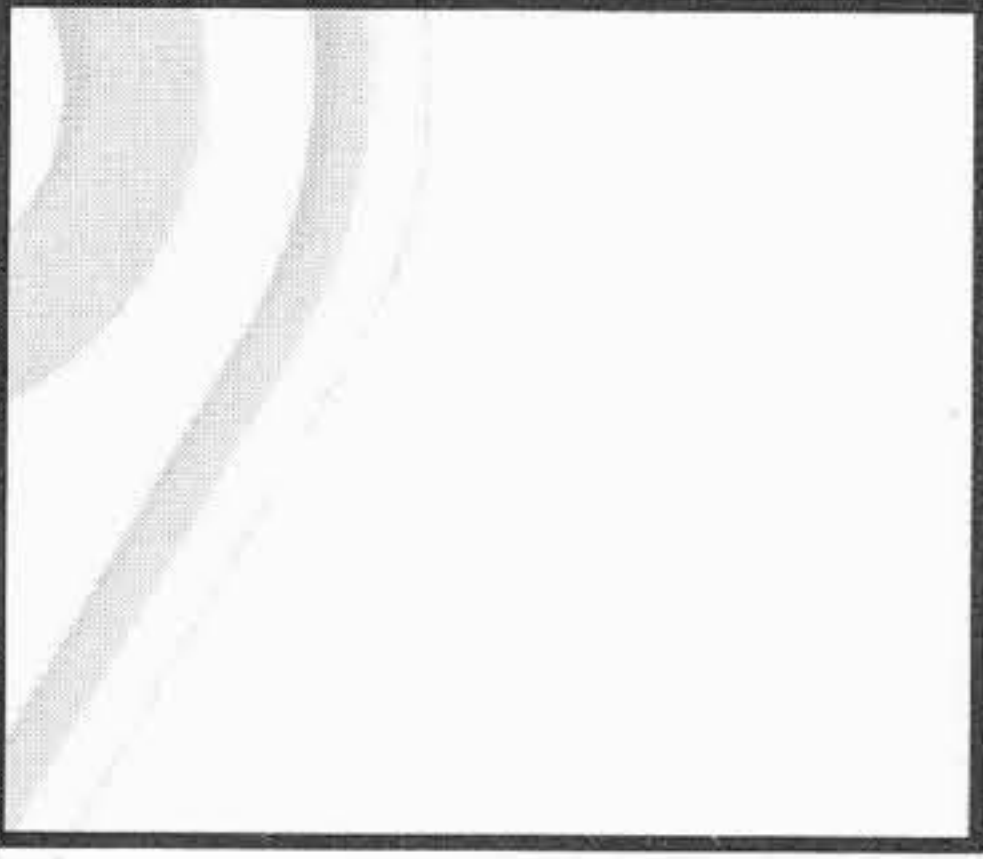
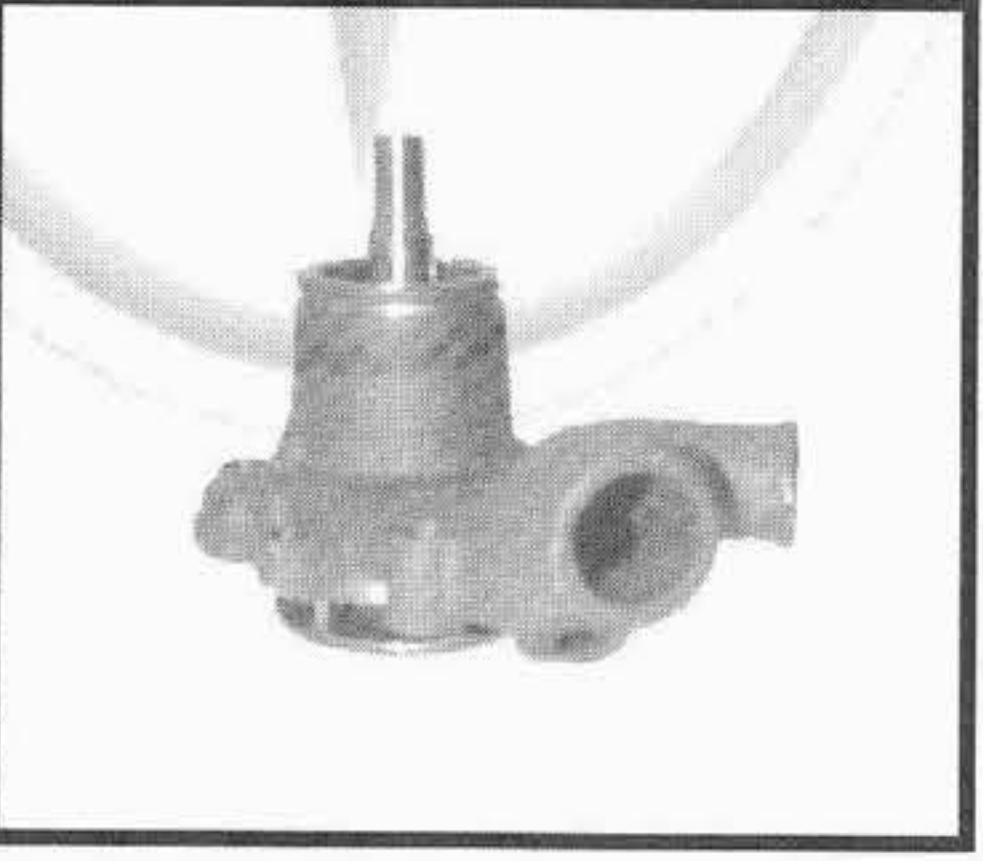
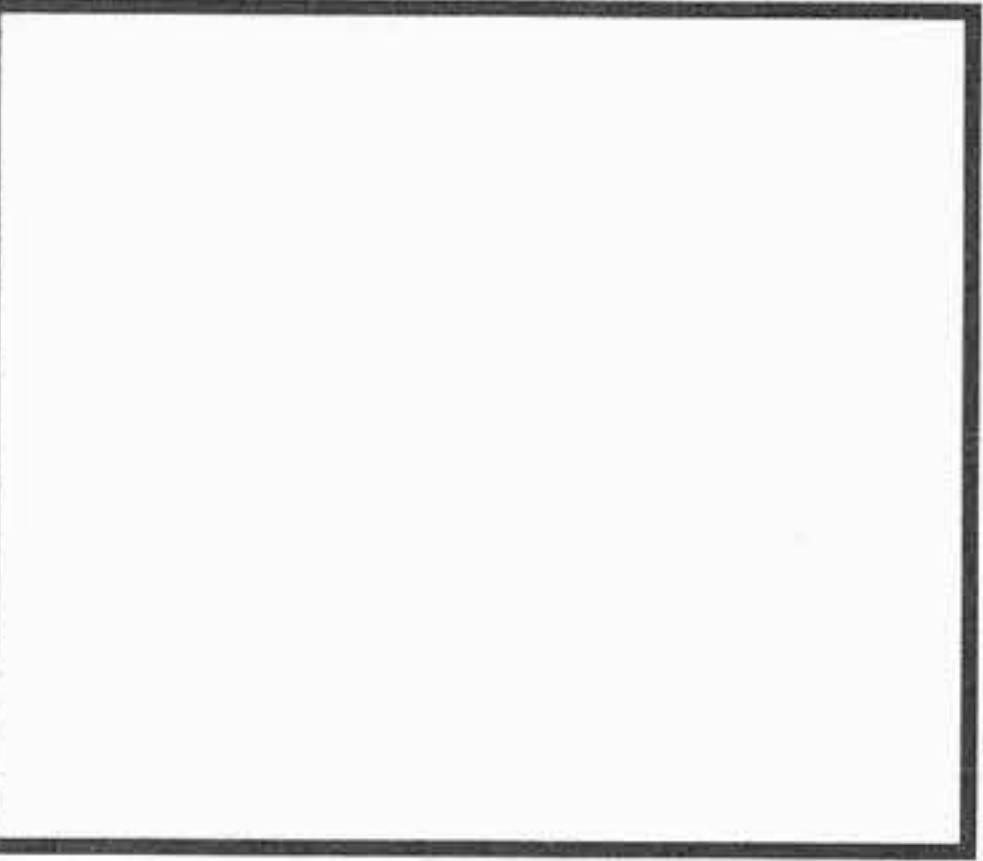
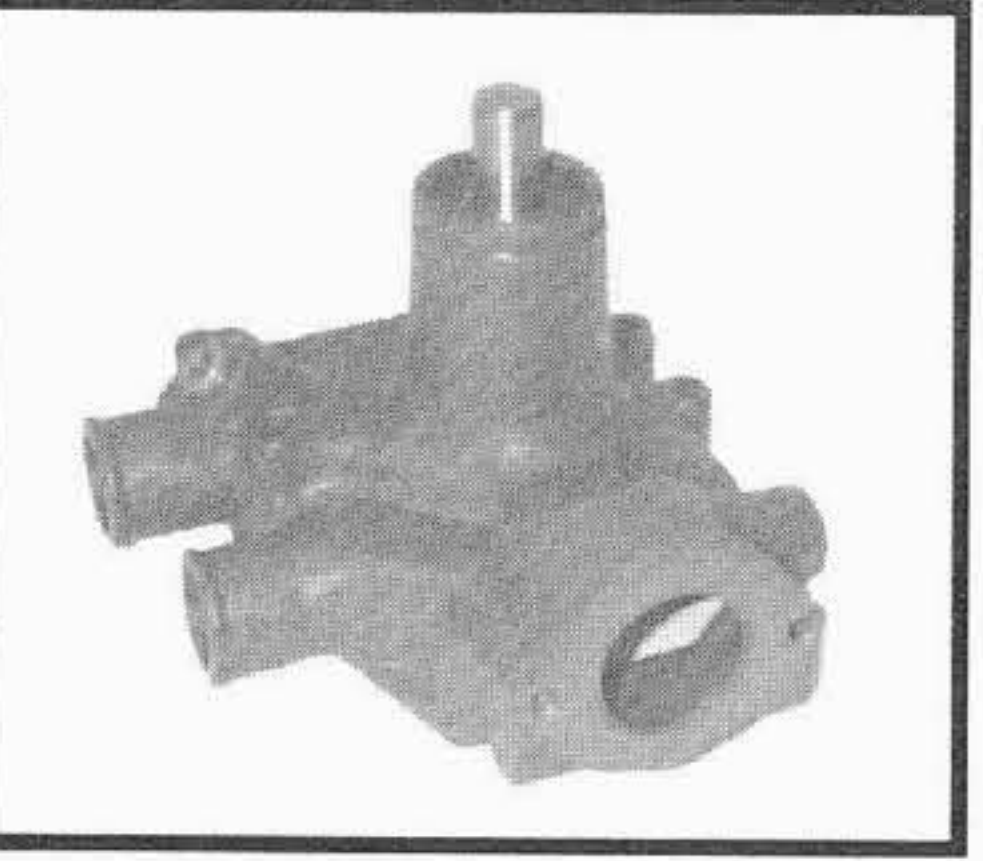
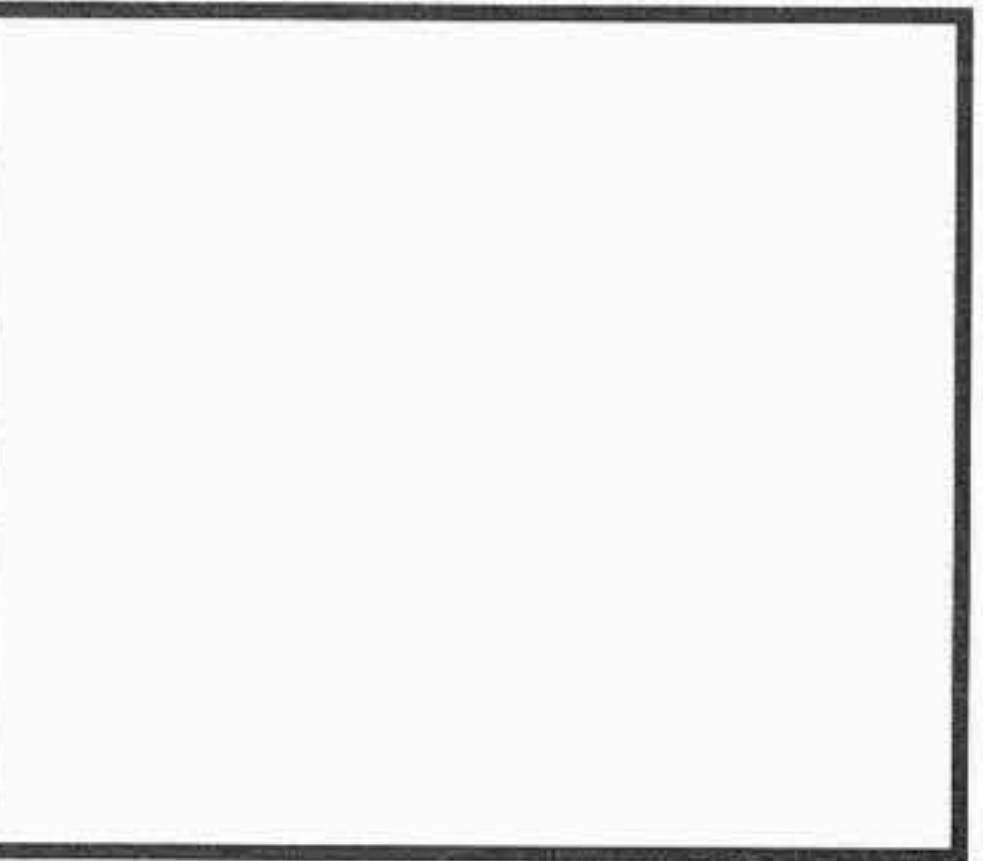

TIPO O MODELLO TYPE OU MODELE TYPE OR MODEL	MOTORE MOTEUR ENGINE	POMPA ACQUA POMPE A EAU WATER PUMP OMP REF. / O.EM. REF	KIT RIPARAZIONE NECESSAIRE DE REP. REPAIR KIT OMP REF. / O.EM. REF
MF 22 C - MF TL 23 N - MF TL 23 DT MF 30 MF 31 - MF 33 MF 50 - MF 50 B/C/D/E/H MF 60 MF 165 <b>1967 / 70</b> MF 168 <b>1971 / 77</b> MF 174/C <b>1969 ---&gt;</b> MF 175 - MF 178 <b>1964 / 75</b> MF 180 MF 184 - MF 185 - MF 188 <b>1971 / 77</b> MF 194 / C - MF 206 MF 255 - MF 265 - MF 274 - MF 275 MF 285 - MF 290 - MF 300 I° TIPO MF 307 Combine MF 374/C - 376C - 384 - 393 - 394/C - 396C MF 400 - MF 487 Combine MF 565 - MF 575 <b>1975 ---&gt;</b> MF 587 Combine MF 590 <b>1975 ---&gt;</b> MF 670 - MF 675 - MF 690 MF 3366 - M 6000	4.248 4.212 4.236 - 4.248 4.212 - 4.236 4.236 A4.212 A4.236 AD4.236 A4.236 - A4.248 4.236 A4.248 4.236 4.236 - A4.248 A4.248 4.236 4.248 4.248 A4.236 4.248 A4.248 4.236 - 4.248 A4.236 - 4.236	<p style="text-align: center;"><b>259.450</b> 41313231P                      CON PULEGGIA / WITH PULLEY</p>  <p style="text-align: center;"><b>159.490</b> 4131A034                      SENZA PULEGGIA / WITHOUT PULLEY</p>	<p style="text-align: center;"><b>152.183</b> U7LW0058                      ALBERO / SHAFT Ø= 5/8 - 18 FIL. X 1"</p>  <p style="text-align: center;"><b>152.112</b> U7LW0025                      ALBERO / SHAFT Ø= 1/2 - 20 FIL. X 1"</p>
MF 670  MF 675  MF 690	4.248	<p style="text-align: center;"><b>259.380</b> 41313212                      SENZA PULEGGIA / WITHOUT PULLEY</p>  <p style="text-align: center;">ad esaurimento sost. da /                      will be supersided by  <b>159.380</b> 41313228</p>	<p style="text-align: center;"><b>152.183</b> U7LW0058</p> 
MF 670  MF 675  MF 690	4.248	<p style="text-align: center;"><b>159.380</b> 41313228                      SENZA PULEGGIA / WITHOUT PULLEY</p> 	<p style="text-align: center;"><b>152.183</b> U7LW0058</p> 
MF 70 - MF 180  MF 285  MF 295 - MF 298  MF 300 DD - MF 320  MF 400 - MF 410  MF 595 - MF 595 S - MF 698  MF 1080  MF 1085 - MF 3366	A4.318  4.318 - 4.318.2  4.318.2 - A4.318  A4.300  4.318.2  A4.300  A4.318	<p style="text-align: center;"><b>159.140</b> U5MW0014                      SENZA PULEGGIA / WITHOUT PULLEY</p>  <p style="text-align: center;">--- 41312419                      CON PULEGGIA / WITH PULLEY</p>	<p style="text-align: center;"><b>152.155</b> U7LW0055</p> 

I ricambi non sono originali ma adattabili . Ogni riferimento originale é assolutamente indicativo .  
 Spare parts are not original but perfectly suitable . Every original part number has to be considered for reference purpose only .



SUITABLE

# MASSEY FERGUSON

Tel:+44(0)1925 850082 Fax: +(0)44 1925 850083

www.spwaterpumps.co.uk

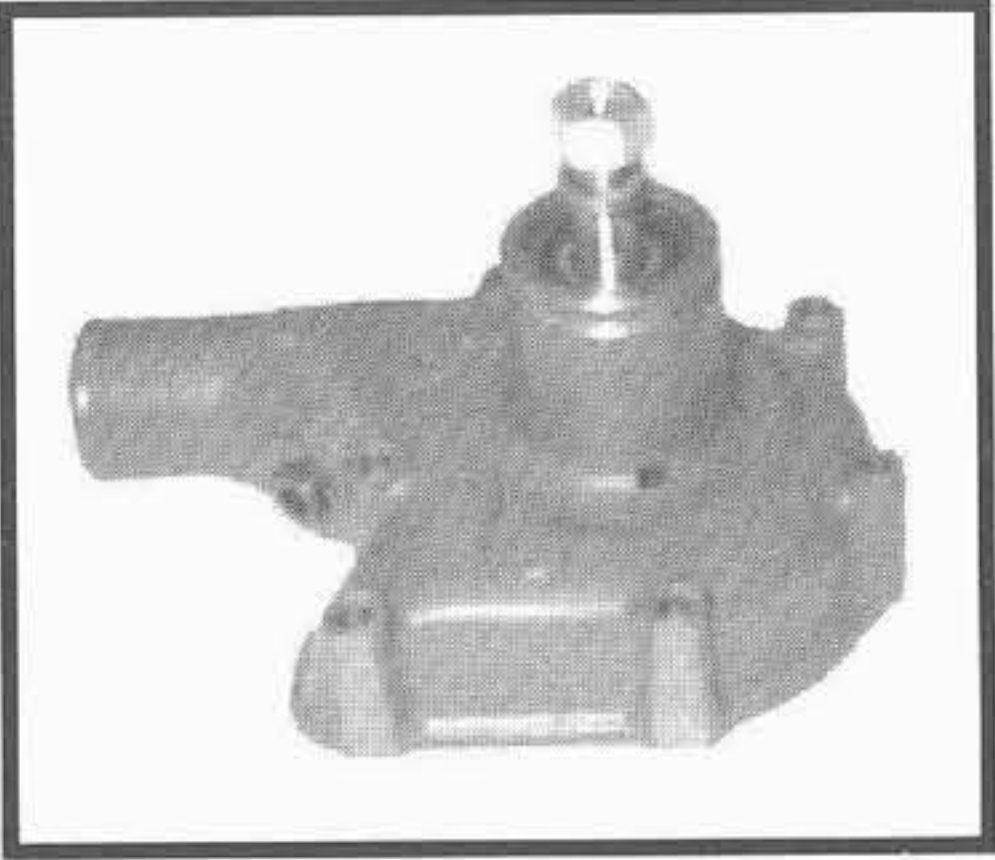
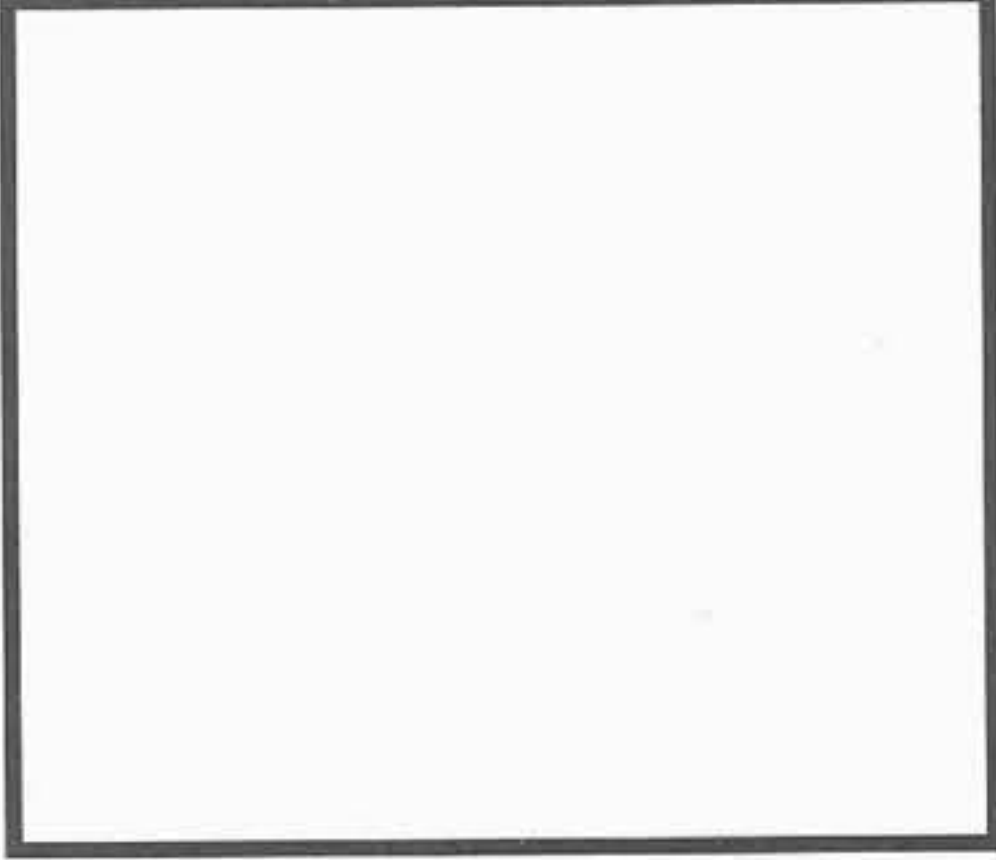
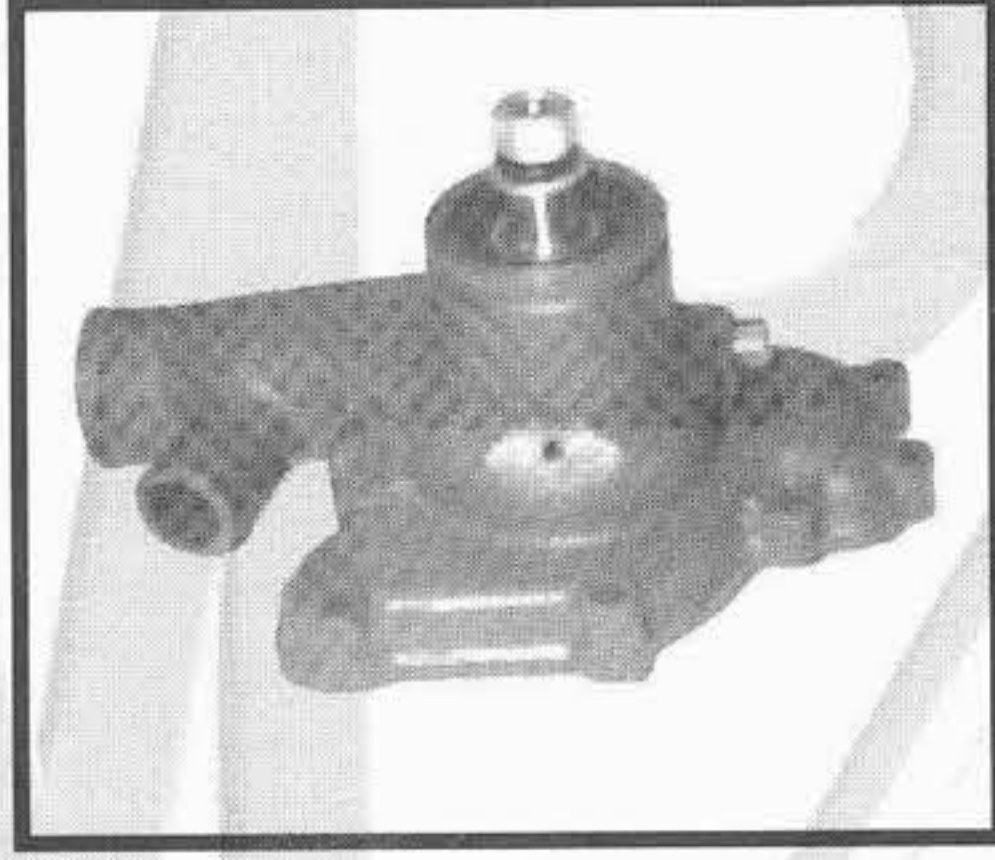
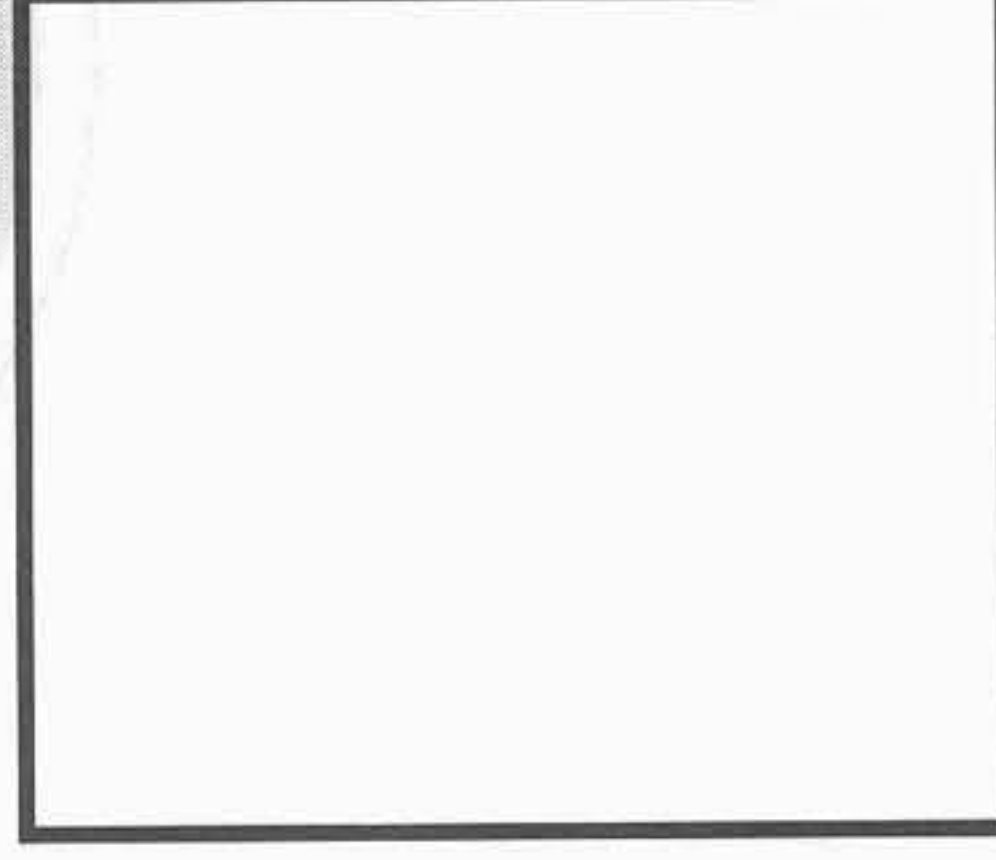
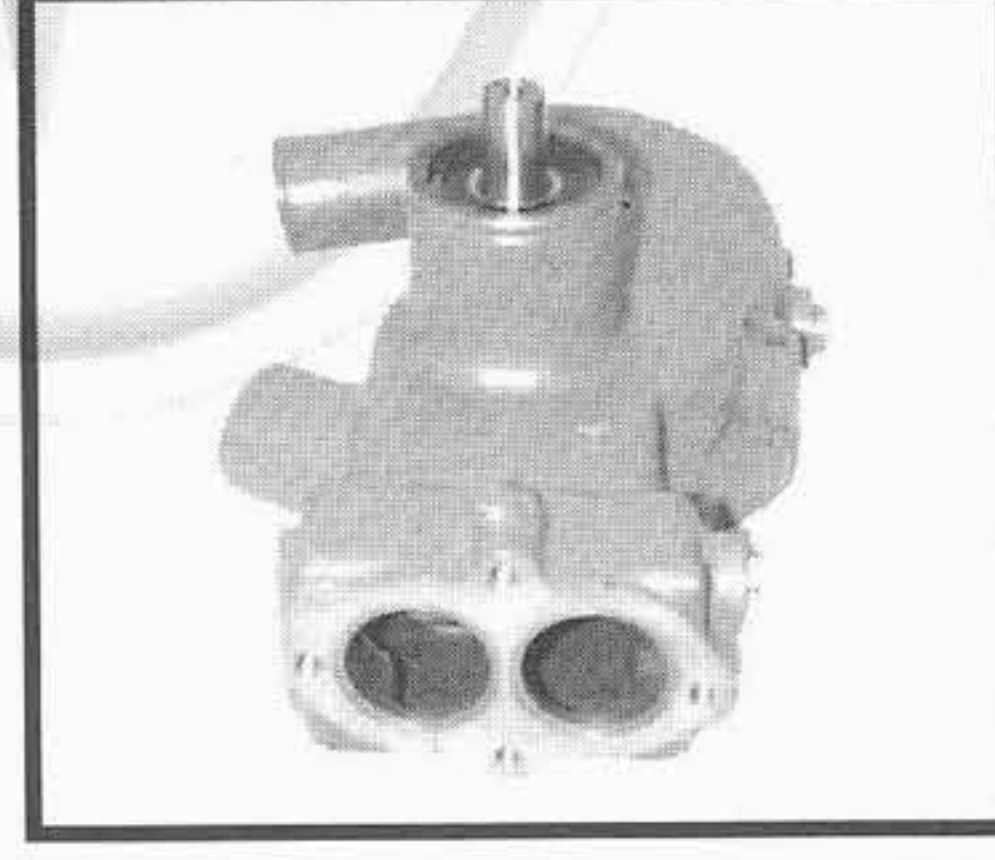
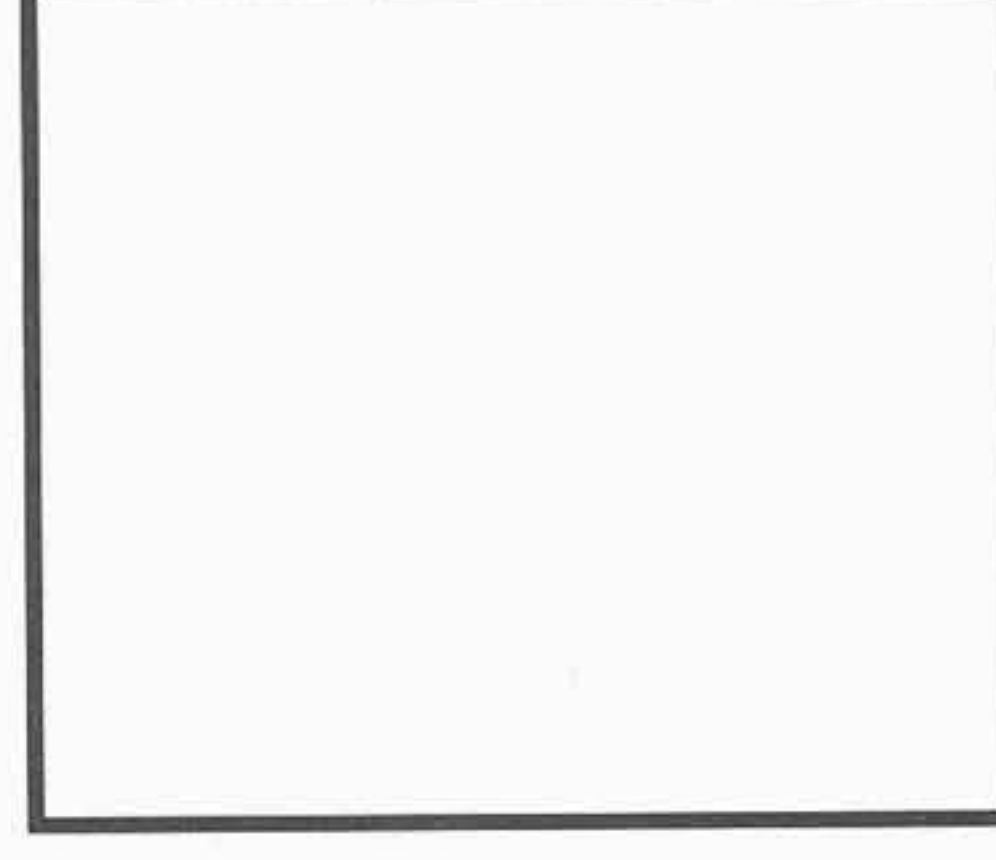

TIPO O MODELLO TYPE OU MODELE TYPE OR MODEL	MOTORE MOTEUR ENGINE	POMPA ACQUA POMPE A EAU WATER PUMP OMP REF. / O.EM. REF	KIT RIPARAZIONE NECESSAIRE DE REP. REPAIR KIT OMP REF. / O.EM. REF
MF 44  MF 80  MF 400  MF 500 - MF 507 - MF 520  MF 525 - MF 530 - MF 541  MF 542  MF 1100      1965 / 67	6.354  A6.354.1  6.354  A6.354  6.354	<p><b>159.090</b>    41313045                      SENZA PULEGGIA / WITHOUT PULLEY</p> 	<p><b>152.097</b>    U7LW0009</p> 
MF 450 E  MF 530  TX 550  MF 542  MF 620.5  MF 620.7  MF 750  MF TX 750	6.354.4  6.354.4  6.354.4  6.354.4  A6.372  A.6.372.4  A6.372.4  A6.372.4	<p><b>159.260</b>    41313047                      SENZA PULEGGIA / WITHOUT PULLEY</p> 	<p><b>252.243</b>    U7LW0020</p> 
MF 44 B  MF 400  MF 450  MF 1100    2° TIPO  MF 1104  MF 1105  MF 1135  MF 1135 - MF 1200	A6.354.4  A6.354.1  A6.354.1  A6.354.4  AT6.354.1  A6.354.1	<p><b>159.230</b>    U5MW0016                      SENZA PULEGGIA / WITHOUT PULLEY</p> 	<p><b>252.136</b>    U7LW0024</p> 
RX 85 - RX 88  MF 399  MF 699  MF 1014  MF 1100    1° TIPO  MF 1134  MF 2620 - MF 2640  MF 2680 - MF 2720  MF 3085 - 3095 - 3115 - 3125  MF 3635 - 3645 - 3655  MF 13000	6.354.4  A6.354.4  6.354.4  A6.354.4  A6.354  AT6.354.4  A6.354.4  T6.354.4 mot. 4691472k-->  T6.354.4  AT6.354.4  6.354.4	<p><b>159.355</b>    41313027                      SENZA PULEGGIA / WITHOUT PULLEY</p> 	<p><b>152.153</b>    U7LW0015</p> 

I ricambi non sono originali ma adattabili . Ogni riferimento originale é assolutamente indicativo .  
 Spare parts are not original but perfectly suitable . Every original part number has to be considered for reference purpose only .

SUITABLE

# MASSEY FERGUSON

Tel: +44(0)1925 850082 Fax: +(0)44 1925 850083

www.spwaterpumps.co.uk

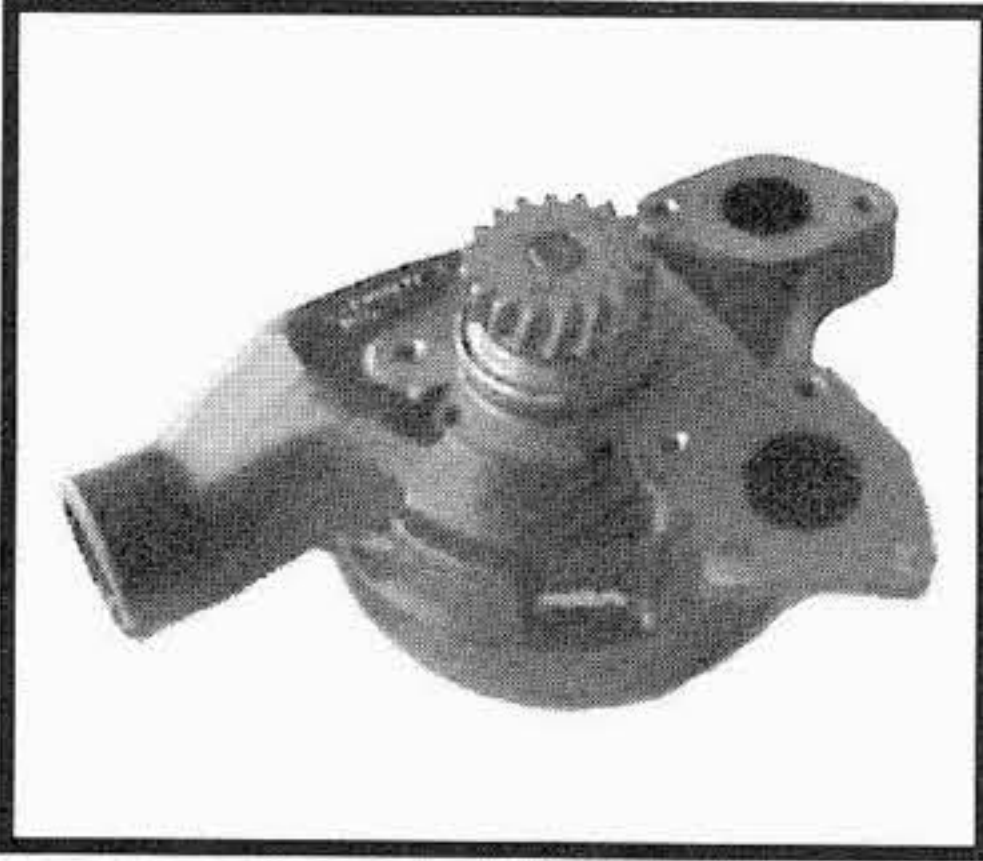
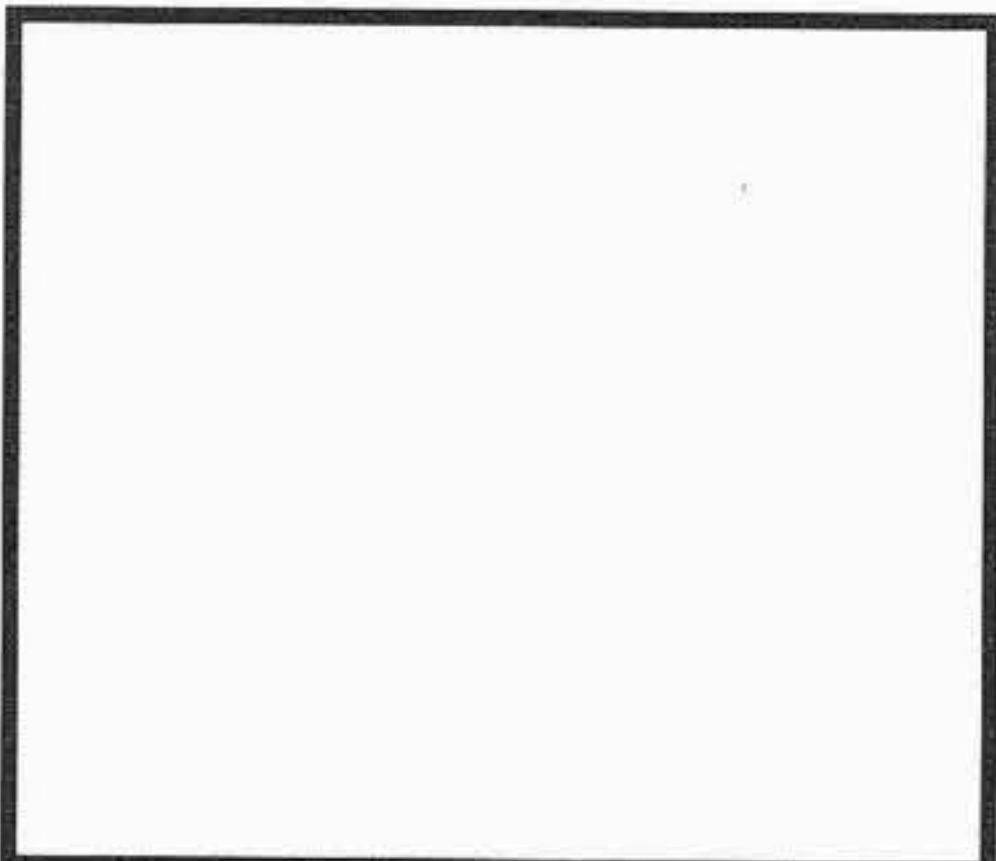
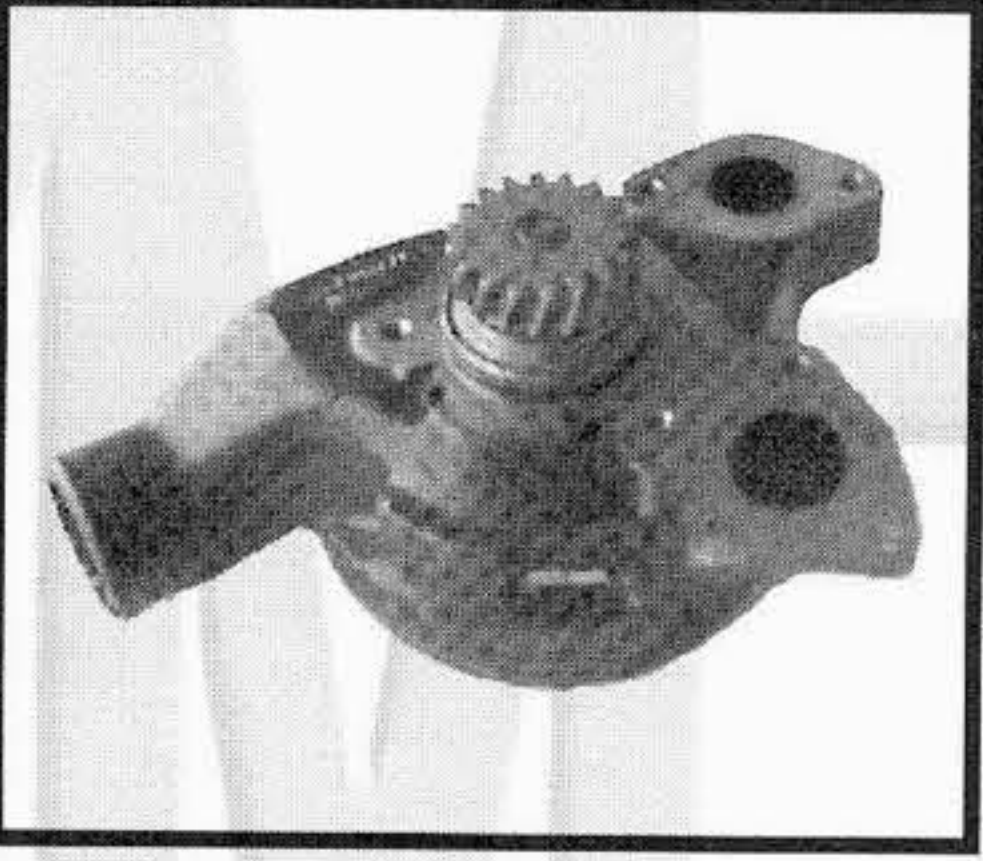
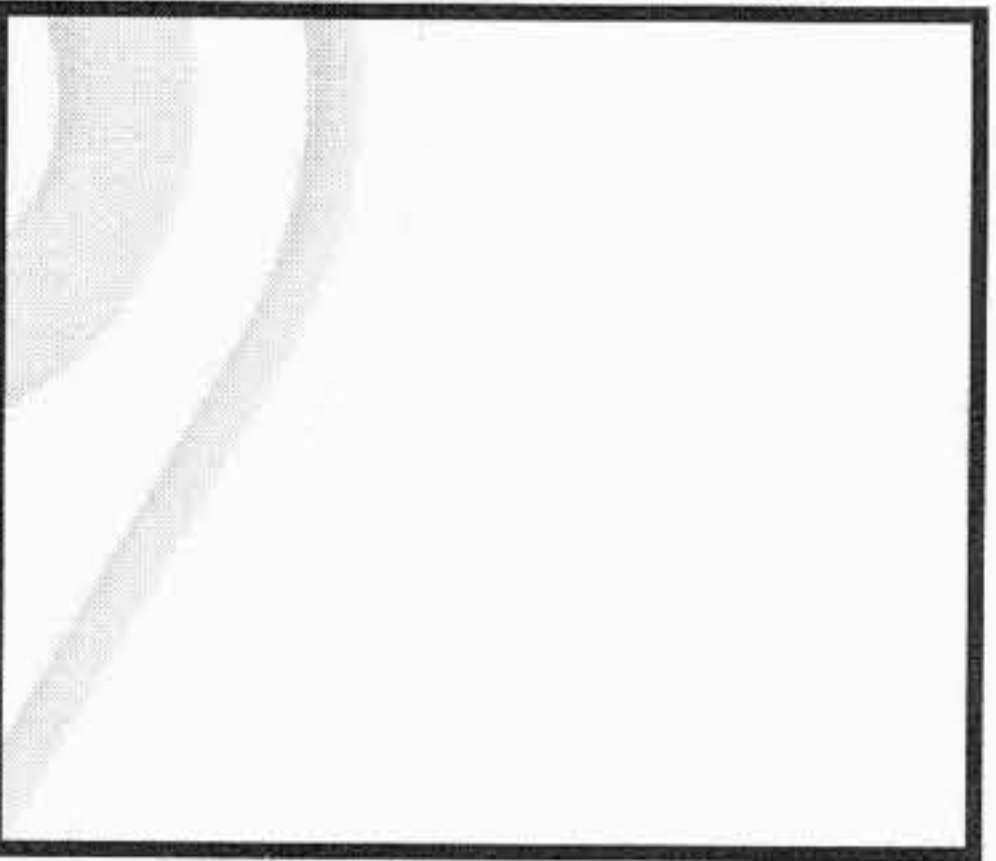
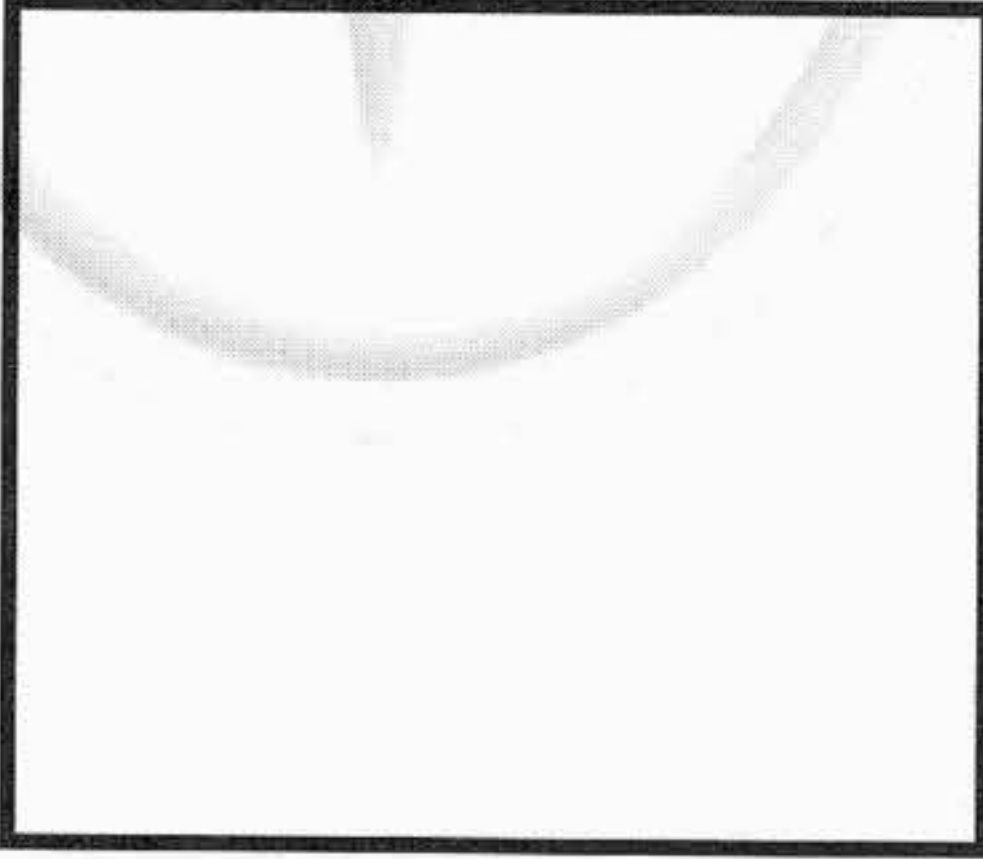
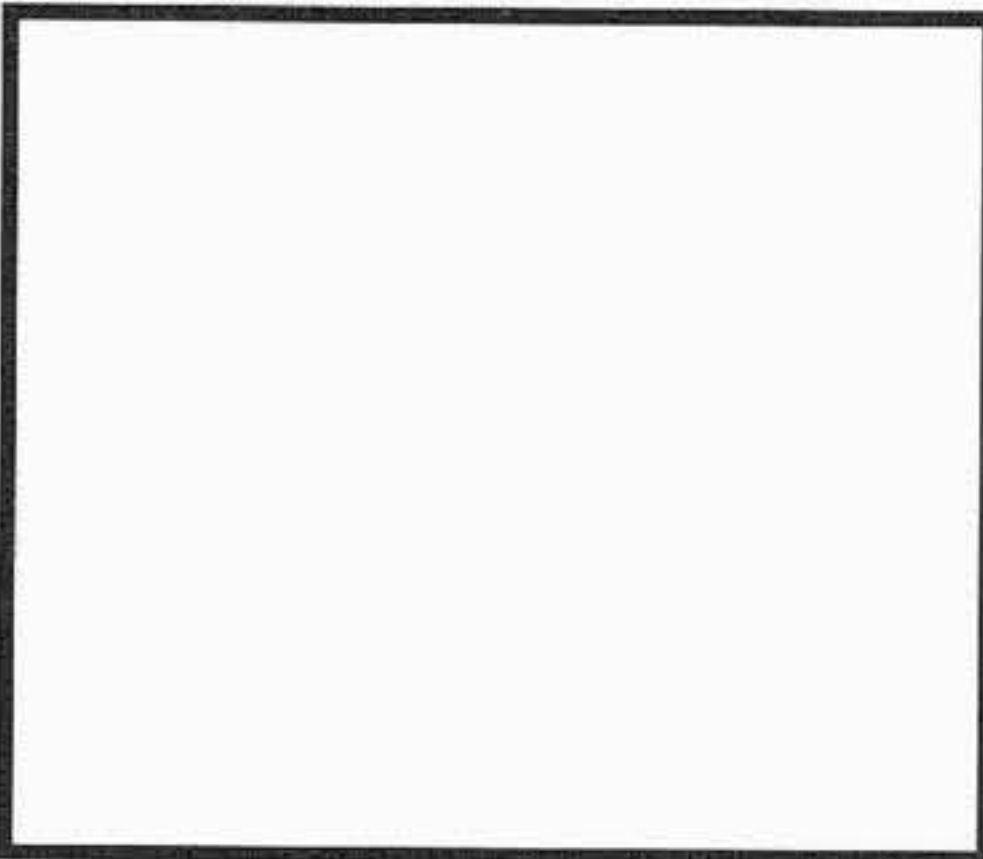
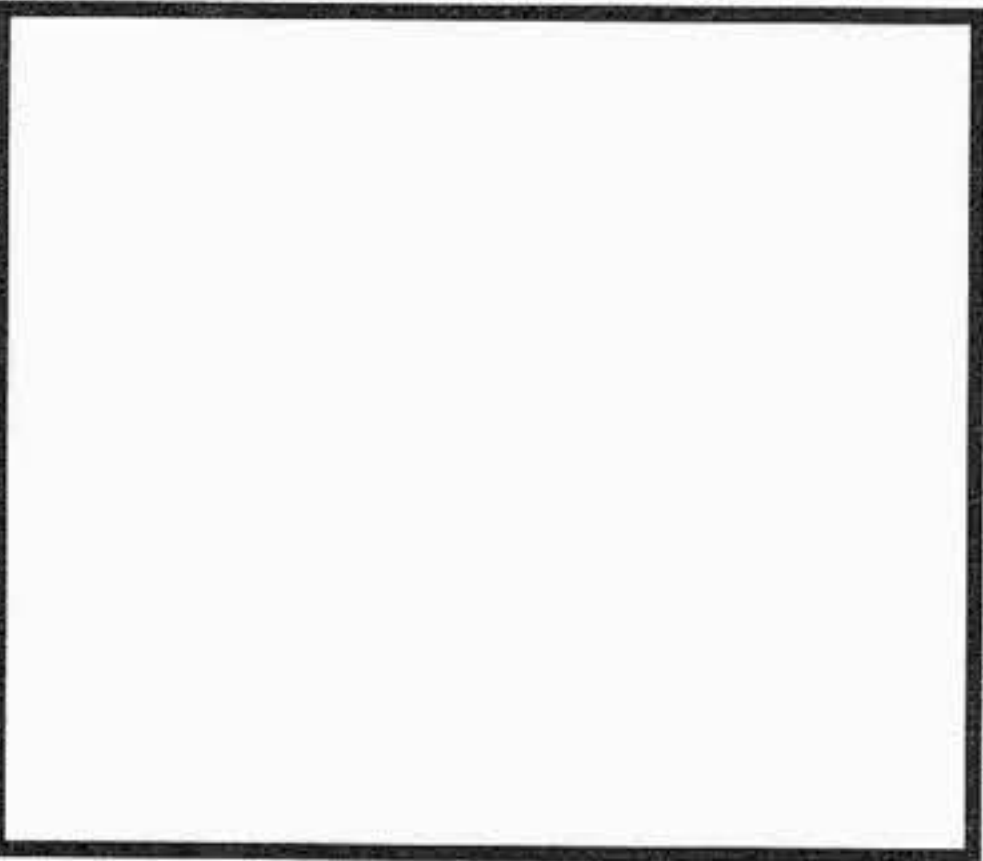
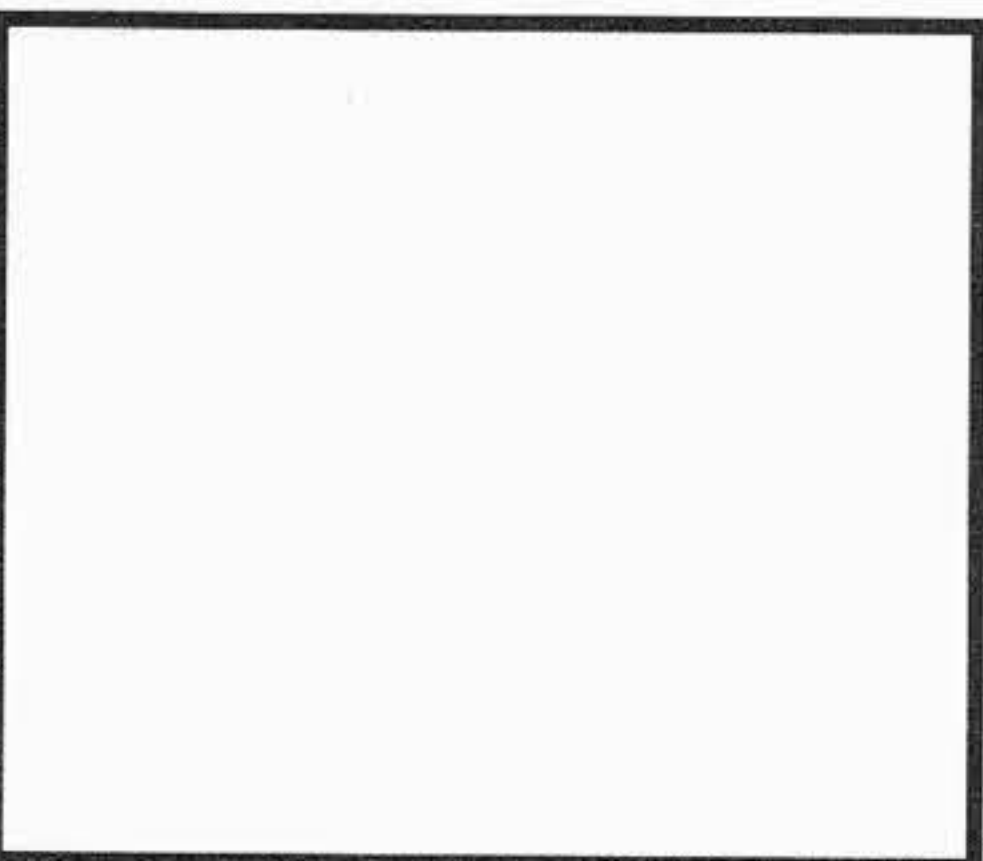

TIPO O MODELLO TYPE OU MODELE TYPE OR MODEL	MOTORE MOTEUR ENGINE	POMPA ACQUA POMPE A EAU WATER PUMP OMP REF. / O.EM. REF	KIT RIPARAZIONE NECESSAIRE DE REP. REPAIR KIT OMP REF. / O.EM. REF
tutti i modelli / all models  4200 Series  MF 4245 - MF 4255  <b>NEW !!</b>	1004.4  1004.4	159.510 4131E012  	152.260 U7LW0071  
<b>NEW !!</b>  MF 399  MF 3085 - MF 3095  MF 3115 - MF 3125  MF 3635 - MF 3645  MF 3655  4200 Series  MF 4260 - MF 4270	1006.6  1006.6	159.500 4131E011  	152.261 U7LW0087  
			
			

I ricambi non sono originali ma adattabili . Ogni riferimento originale é assolutamente indicativo .  
 Spare parts are not original but perfectly suitable . Every original part number has to be considered for reference purpose only .



## **SECTION 16**

### **APPLICATION**

# **NEW HOLLAND**

**AGRIFULL - FIAT ALLIS  
FIAT HITACHI - SIMIT - BENATI  
FIAT TRATTORI - LAVERDA - FORD**

**WATER PUMPS WASSERPUMPEN  
POMPE A EAU BOMBA DE AGUA  
POMPA ACQUA**

**S.P. WATER PUMPS LTD  
18 Tatton Court, Kingsland Grange, Woolston,  
Warrington, Cheshire. ENGLAND. WAI 4RR  
TEL: +44(0) 1925 850082 Fax: +44(0) 1925 850083  
Email:sales@spwaterpumps.co.uk Web Site:www.spwaterpumps.co.uk**

TAVOLE DI CONVERSIONE  
TABLE DE CONVERSION  
CONVERSION TABLE

NEW HOLLAND

AGRIFULL - FIAT ALLIS  
FIAT HITACHI - SIMIT  
BENATI - FIAT TRATTORI  
LAVERDA



NUMERO ORIGINALE NUMERO ORIGINAL ORIGINAL NUMBER	NUMERO SOSTITUTIVO REPLACE PAR NUMERO REPLACED BY NUMBER	RIFERIMENTO OMP REFERENCE OMP OMP REFERENCE
89034	U7LW0006	
89036	U7LW0009	
539672		201.584
540454		211.462
540456	VEDI 777.837	211.461
540461	VEDI 777.837	211.467
543747	ESAURO	
546018		201.586
549420	ESAURO	
549421	ESAURO	
550734	ESAURO	
552113		211.445
552161		211.454
552162		211.459
552163		211.452
552164		211.447
552165		211.446
552170		211.466
552387		201.587
552402	581677	
552406		196.012
552408		208.086
552478		ESAURO
554148		ESAURO
554150		208.035
554568		191.157
554571		191.164
559213		191.266
560226		208.040
560948		201.139
560949		191.188
561229		201.431
561232		201.428
561233		201.434
561234		201.535
561235		201.530
561242		208.085
561514		201.420
562499	4581535	
562988		191.155
562993		191.162
565079		ESAURO
565236		228.003
565394		201.396
565395	4605899	
565396		201.419
565511		201.453

NUMERO ORIGINALE NUMERO ORIGINAL ORIGINAL NUMBER	NUMERO SOSTITUTIVO REPLACE PAR NUMERO REPLACED BY NUMBER	RIFERIMENTO OMP REFERENCE OMP OMP REFERENCE
565975		ESAURO
566286		201.395
566997		201.390
567400		201.398
569397		201.392
569406		201.369
569659		ESAURO
570636		ESAURO
570638		208.087
570639		208.017
570888	4138766	
570948		ESAURO
572196		ESAURO
572725		ESAURO
572845		201.006
574352	AD ESAUR.	198.057
574526	VEDI 777.182	
574712		208.004
574714		ESAURO
574965		ESAURO
577837		221.450
580087		208.100
580210		201.588
580301		ESAURO
580303		228.002
581677		201.577
581678	586018	
581679		208.093
586017		201.590
586018		208.094
586861		ESAURO
588613	598876	
589323	562988	
590795		208.031
594278		ESAURO
594281		ESAURO
594650		ESAURO
594656		ESAURO
594660		ESAURO
595367		201.947
596443		ESAURO
598378		ESAURO
598876		228.007
813579	VEDI 777.988	
841062	VEDI 777.988	
841767		191.027
844379	VEDI 777.988	

OGNI RIFERIMENTO ORIGINALE E' ASSOLUTAMENTE INDICATIVO. CHAQUE REFERENCE ORIGINAL EST ABSOLUMENT INDICATIVE. EVERY ORIGINAL PART NUMBER HAS TO BE CONSIDERED FOR REFERENCE PURPOSE ONLY.



TAVOLE DI CONVERSIONE  
TABLE DE CONVERSION  
CONVERSION TABLE

NEW HOLLAND

AGRIFULL - FIAT ALLIS  
FIAT HITACHI - SIMIT  
BENATI - FIAT TRATTORI  
LAVERDA



NUMERO ORIGINALE NUMERO ORIGINAL ORIGINAL NUMBER	NUMERO SOSTITUTIVO REPLACE PAR NUMERO REPLACED BY NUMBER	RIFERIMENTO OMP REFERENCE OMP OMP REFERENCE
882723		191.405
969761		191.534
999285	Gh	191.160
0170040		251.184
0500006		251.191
0576007		259.031
0920009		259.032
0920058		251.772
1756143		203.155
1756186		203.160
1756509		203.154
1756510		201.815
1756511		201.805
1756512		203.162
1756513		203.153
1756514		203.156
1909615		202.056
1909616	1909952	
1909617	1909829	
1909619		202.025
1909620	ad esaurimento	202.049
1909621	ad esaurimento	202.029
1909623		202.041
1909624	76031329	
1909625		202.033
1909626	76029352	
1909627		202.053
1909635	ESAURITO	
1909789	1930262	
1909790		201.929
1909829		202.016
1909952	76032963	
1930196	1930445	
1930262	1940119	
1930445	1940105	
1930925		196.326
1940104		222.261
1940105		222.264
1940119		202.268
1940144		222.281
2331154		259.041
4171520	11060275	
4519897	4557736	
4537931		261.282
4541160		ESAURITO
4541161		ESAURITO
4541162		ESAURITO

NUMERO ORIGINALE NUMERO ORIGINAL ORIGINAL NUMBER	NUMERO SOSTITUTIVO REPLACE PAR NUMERO REPLACED BY NUMBER	RIFERIMENTO OMP REFERENCE OMP OMP REFERENCE
4547439	VEDI 777.897	
4547452		191.293
4547543		191.279
4547634	VEDI 777.897	
4547637	VEDI 777.897	
4547912		191.277
4557736	4613393	
4581535		208.084
4585990	4587258	
4587048		191.192
4587050		191.186
4587258		191.183
4591436		191.283
4591437		191.290
4591438		201.203
4592557		191.278
4593236		201.538
4593322		208.082
4593360		ESAURITO
4594089	4602503	
4595833		201.513
4599557		191.237
4599560	VEDI 777.182	
4599561	VEDI 777.182	
4599562	VEDI 777.182	
4599563	VEDI 777.182	
4600130		208.018
4600187		ESAURITO
4602502		191.285
4602503		191.190
4603862	4617099	
4603866	4612265	
4603868	4654154	
4603869	4654154	
4603870		191.207
4603871		191.231
4605899		201.594
4606028		191.304
4606030		191.298
4606031	4757006	
4606032	4619257	
4606033		191.299
4606034	VEDI 777.023	
4606042	VEDI 777.023	
4606046	VEDI 777.023	
4606051		191.297
4606070	4622485	

OGNI RIFERIMENTO ORIGINALE E' ASSOLUTAMENTE INDICATIVO. CHAQUE REFERENCE ORIGINAL EST ABSOLUMENT INDICATIVE. EVERY ORIGINAL PART NUMBER HAS TO BE CONSIDERED FOR REFERENCE PURPOSE ONLY.

TAVOLE DI CONVERSIONE  
TABLE DE CONVERSION  
CONVERSION TABLE

NEW HOLLAND

AGRIFULL - FIAT ALLIS  
FIAT HITACHI - SIMIT  
BENATI - FIAT TRATTORI  
LAVERDA



NUMERO ORIGINALE NUMERO ORIGINAL ORIGINAL NUMBER	NUMERO SOSTITUTIVO REPLACE PAR NUMERO REPLACED BY NUMBER	RIFERIMENTO OMP REFERENCE OMP OMP REFERENCE
4606094	VEDI 777.023	
4606783		228.166
4606784		ESAURO
4611308		4658400
4612264		4639096
4612265		4622265
4612675		4655054
4613393		4613395
4613395		191.280
4613684		ESAURO
4616630		191.249
4617099		201.982
4619257		4757008
4619285		ESAURO
4619286		ESAURO
4621413		208.078
4622265		4639097
4622324		ESAURO
4622485		4666429
4622591		208.065
4622957		198.114
4628338		198.169
4629940		201.596
4629942		208.101
4629943		208.102
4629944		201.592
4639096		191.138
4639097		191.239
4642042		191.142
4651309		198.109
4654154		191.247
4655011		191.260
4655014	4736987	
4655054	4679242	
4658400		191.294
4666429	AD ESAUR.	198.048
4671954		191.382
4672087	VEDI 777.786	
4672088	VEDI 777.786	
4673810	VEDI 777.182	
4677587	VEDI 777.786	
4679242	93191101	
4679303	4679242	
4692491	4732395	
4692493		201.097
4692494		191.099
4692495		201.098

NUMERO ORIGINALE NUMERO ORIGINAL ORIGINAL NUMBER	NUMERO SOSTITUTIVO REPLACE PAR NUMERO REPLACED BY NUMBER	RIFERIMENTO OMP REFERENCE OMP OMP REFERENCE
4693901		ESAURO
4695786	4737154	
4696705		201.572
4696706		201.626
4696707	1930925	
4697121		208.185
4697144		201.094
4699618		228.244
4699831		228.284
4706879		201.669
4706880		201.682
4711702		191.686
4711704		191.667
4711705	VEDI 777.634	
4712083	VEDI 777.634	
4714271		228.287
4721390		228.248
4723063		196.327
4732064		201.959
4723065		221.958
4725903		201.087
4726361		201.931
4726860		201.921
4726861		201.919
4727139	4796534	
4727145		201.923
4731643		201.922
4732341	4761926	
4732378	4762039	
4732393	4757340	
4732394		ESAURO
4732395	4757341	
4736987		208.095
4737154	4764156	
4737157		198.250
4742370		201.961
4746402	4796537	
4752545		191.669
4752546		191.682
4755791		201.937
4755792		201.936
4755793		201.934
4757006		191.302
4757008		191.295
4757340		201.955
4757341		201.935
4758023		201.964

OGNI RIFERIMENTO ORIGINALE E' ASSOLUTAMENTE INDICATIVO. CHAQUE REFERENCE ORIGINAL EST ABSOLUMENT INDICATIVE. EVERY ORIGINAL PART NUMBER HAS TO BE CONSIDERED FOR REFERENCE PURPOSE ONLY.

TAVOLE DI CONVERSIONE  
TABLE DE CONVERSION  
CONVERSION TABLE

NEW HOLLAND

AGRIFULL - FIAT ALLIS  
FIAT HITACHI - SIMIT  
BENATI - FIAT TRATTORI  
LAVERDA



NUMERO ORIGINALE NUMERO ORIGINAL ORIGINAL NUMBER	NUMERO SOSTITUTIVO REPLACE PAR NUMERO REPLACED BY NUMBER	RIFERIMENTO OMP REFERENCE OMP OMP REFERENCE
4758025		228.255
4758190		201.975
4758191		201.985
4758268		201.977
4758269		228.256
4758414		201.962
4758415		228.261
4758416		201.963
4758417		228.262
4761559		228.278
4761615		206.010
4761955		228.279
4762001		228.263
4762039	4796531	
4763383		201.974
4764090		196.014
4764156		196.015
4764158		196.017
4770614	4813442	
4780568	4784454	
4784078	4829218	
4784454	4813370	
4787092	4808080	
4796529		206.053
4796531	4807113	
4796534		206.100
4796537		206.200
4800484	4813730	
4807113	98410023	
4807116		206.144
4807395		208.326
4808080		206.148
4813370		206.265
4813371		206.295
4813442		206.068
4813730	98497117	
4814563		208.340
4817651		206.380
4829218		206.077
4951264		ESAU RITO
4951280		ESAU RITO
4951415		208.032
4951829		208.133
4952496	79003080	201.965
4953502		208.034
4953503		208.188
4955190		201.680

NUMERO ORIGINALE NUMERO ORIGINAL ORIGINAL NUMBER	NUMERO SOSTITUTIVO REPLACE PAR NUMERO REPLACED BY NUMBER	RIFERIMENTO OMP REFERENCE OMP OMP REFERENCE
4959164		201.597
4959165		208.103
7130396		221.909
7302756		196.183
7302776	98421056	
8107660		206.205
8310085		ESAU RITO
8310087		221.911
8312029		221.908
8312031		221.928
8312034		ESAU RITO
8807765		211.456
8810326		211.463
8810327		221.468
8813011		191.407
8813157		191.406
8814938		191.414
8814939	VEDI 777.790	
8814940		191.415
8815774		ESAU RITO
8815776		191.206
8815777		ESAU RITO
8818176		ESAU RITO
8818227		211.489
8818228		211.487
8818239	VEDI 777.780	
8819120	AD ESAUR.	198.074
8819324	8824528	
8819394		208.151
8819898		221.912
8820040	8822883	
8820041		221.482
8820042		221.486
8820043		221.481
8820044		221.479
8820045	AD ESAUR.	198.096
8821431		211.488
8821437		ESAU RITO
8821438	VEDI 777.779	211.528
8821439		211.527
8821786		208.187
8822774	8829182	
8822833		211.529
8822971	8826871	
8822883	8829787	
8822887		221.493
8822950	AD ESAUR.	

OGNI RIFERIMENTO ORIGINALE E' ASSOLUTAMENTE INDICATIVO. CHAQUE REFERENCE ORIGINAL EST ABSOLUMENT INDICATIVE. EVERY ORIGINAL PART NUMBER HAS TO BE CONSIDERED FOR REFERENCE PURPOSE ONLY.

TAVOLE DI CONVERSIONE  
TABLE DE CONVERSION  
CONVERSION TABLE

NEW HOLLAND

AGRIFULL - FIAT ALLIS  
FIAT HITACHI - SIMIT  
BENATI - FIAT TRATTORI  
LAVERDA



NUMERO ORIGINALE NUMERO ORIGINAL ORIGINAL NUMBER	NUMERO SOSTITUTIVO REPLACE PAR NUMERO REPLACED BY NUMBER	RIFERIMENTO OMP REFERENCE OMP OMP REFERENCE
8822981		221.483
8823283	8829183	
8823963		198.116
8824005	VEDI 777.780	
8824006	8829187	201.607
8824049		228.153
8824528		208.098
8824708		201.613
8825046		208.152
8825427		ESAURO
8825545		8829780
8825548		228.149
8825550		228.148
8826053	8829793	
8826054		201.598
8826055		201.601
8826056	8829792	
8826073		191.599
8826149	VEDI 777.634	
8826839		
8826870		ESAURO
8826871		218.355
8826872		211.993
8826873		211.994
8827706		208.150
8827709		208.019
8827712		ESAURO
8827714		228.223
8827770		ESAURO
8828792		
8829126		191.418
8829127		191.402
8829148		191.409
8829182		191.492
8829183		191.476
8829184		211.521
8829187		201.608
8829329	VEDI 211.501	
8829330		211.499
8829331		211.501
8829779		211.520
8829780		201.606
8829787		221.485
8829790		201.490
8829792		191.464
8829793	4732393	
8829805		201.604

NUMERO ORIGINALE NUMERO ORIGINAL ORIGINAL NUMBER	NUMERO SOSTITUTIVO REPLACE PAR NUMERO REPLACED BY NUMBER	RIFERIMENTO OMP REFERENCE OMP OMP REFERENCE
8830638		228.259
8830732		201.920
10010290		201.388
10012490		211.448
10043690		201.583
10014890		201.582
10205720		191.167
10205820		191.191
10205920		191.281
10257460		201.602
10257060		191.533
10264660		201.084
10268450		201.953
10282460		191.384
10284585		201.512
10296685		201.509
10300611		191.383
10300771		191.532
10356111	30002797	
10516670		191.213
10520011	13550501	
10520101		201.992
10725627		201.954
10791040	12164740	
11059475		191.158
11059775		201.389
11060275		191.184
11060576		191.284
11061075		261.354
11061576		201.979
11062476		201.978
11190571		206.102
11198071		191.381
12164740		191.408
12429820		191.289
12430120		191.288
12575611		191.144
12638670		191.146
12644901		221.916
12644920		191.317
12683380	VEDI 777.837	
13301401		191.169
13301501		201.949
13303511		201.937
13403410	13408411	
13407811		191.268
13408411		191.166

OGNI RIFERIMENTO ORIGINALE E' ASSOLUTAMENTE INDICATIVO. CHAQUE REFERENCE ORIGINAL EST ABSOLUMENT INDICATIVE. EVERY ORIGINAL PART NUMBER HAS TO BE CONSIDERED FOR REFERENCE PURPOSE ONLY.

TAVOLE DI CONVERSIONE  
TABLE DE CONVERSION  
CONVERSION TABLE

NEW HOLLAND

AGRIFULL - FIAT ALLIS  
FIAT HITACHI - SIMIT  
BENATI - FIAT TRATTORI  
LAVERDA



NUMERO ORIGINALE NUMERO ORIGINAL ORIGINAL NUMBER	NUMERO SOSTITUTIVO REPLACE PAR NUMERO REPLACED BY NUMBER	RIFERIMENTO OMP REFERENCE OMP OMP REFERENCE
13449521		201.918
13449821		201.933
13517021		191.306
13517321		191.307
13517921		191.305
13550501		191.201
13598121		191.181
13598211		191.316
13739911		206.139
13748610		191.234
14044171		191.296
14325001		191.182
15888721		206.103
16043421		191.238
16043821		191.378
16043921		211.522
16044521		191.379
16100811		191.214
16109211		221.546
20556690		211.449
20558440		211.451
20885620		191.286
20888670		191.318
2418M001	2418M004	
2418M004		259.428
24940010		201.391
24940020		201.394
24940280		191.163
2521D406		259.158
26794880		191.355
28040050		201.549
28042300		191.187
28044120		191.185
30001037		201.497
30002797		191.411
31146952		259.015
3276P003		259.014
32764119	32764127	
32764124		259.078
32764127	3276P003	
3312K011		259.156
3312K012		251.204
3312N003		259.241
33143409		259.077
33157108		259.019
33157109		259.017
33813313		259.018

NUMERO ORIGINALE NUMERO ORIGINAL ORIGINAL NUMBER	NUMERO SOSTITUTIVO REPLACE PAR NUMERO REPLACED BY NUMBER	RIFERIMENTO OMP REFERENCE OMP OMP REFERENCE
36866271		259.042
36866724	36866271	
36867108		259.101
36867137		259.087
37447603		259.076
37447632		259.084
38823313		211.524
38823992		201.609
38824001	VEDI 777.780	
38824166		201.496
41312551	41312911	
41312557	41313018	
41312911	41313201	
41313018	41313045	
41313033	41313047	
41313045		159.090
41313047		159.260
41313201	41313225	
41313225	41313231	
41313231	4131A013	159.450
4131A013	4131A021	
4131A021		159.490
42530032		196.446
61088139		196.355
61315464		196.450
76029352		222.260
76030102		222.263
76031213		202.270
76031329		222.262
76032963		222.267
76032964		202.271
76032965		202.272
76032966		202.273
76032967		202.269
76191549		221.020
76192604		221.025
79003080	79014642	
79003084		228.280
79003086		
79003087		
79003088		
79011045		228.192
79013267		
79013268		
79014642	79037310	201.960
79014644		201.927
79014645		228.260

OGNI RIFERIMENTO ORIGINALE E' ASSOLUTAMENTE INDICATIVO. CHAQUE REFERENCE ORIGINAL EST ABSOLUMENT INDICATIVE. EVERY ORIGINAL PART NUMBER HAS TO BE CONSIDERED FOR REFERENCE PURPOSE ONLY.



TAVOLE DI CONVERSIONE  
TABLE DE CONVERSION  
CONVERSION TABLE

NEW HOLLAND FORD



NUMERO ORIGINALE NUMERO ORIGINAL ORIGINAL NUMBER	NUMERO SOSTITUTIVO REPLACE PAR NUMERO REPLACED BY NUMBER	RIFERIMENTO OMP REFERENCE OMP OMP REFERENCE
E2169T9	E158Z9	
E158Z9		162.130
34806S36		161.381
87652S2		161.182
304758S36		164.008
957E8501B		164.080
957E8505B		169.301
957E8507		169.068
957E8509		164.072
957E8512		169.061
C3AE8564A	C5NE8564B1A	
C5NE8A514A		164.044
C5NE8501A	C5NF8501A	
C5NE8507A		164.047
C5NE8509A		164.005
C5NE8513A		164.011
C5NE8530B		164.001
C5NE8564B1A		161.042
C5NE8578B		164.001
C5NF8501A	C5NN8501A	
C5NN8501A	D5NN8501E	
C7NN8516A		164.006
C9NN8501A	D8NN8501MB	
C9NN8501B	D8NN8501MB	
CFPN8591A	DJPN8591A	
D3NN8501A	D5NN8501E	
D5NN8A528A		164.105
D5NN8A528B		164.035
D5NN8501E	D8NN8501UA	164.000
D5NN8505A		164.012
D5NN8512BA	D8NN8512BA	
D5TE8A559C1A		169.428
D5TE8564B1A		161.042
D8NN8A513MC	FAPN8A513GG	
D8NN8501MB	D8NN8501MC	
D8NN8501MC	VEDI 164.093	
D8NN8501PA	D8NN8501TC	
D8NN8501PB	D8NN8501TC	
D8NN8501SB	D8NN8501MB	
D8NN8501TB	D8NN8501TC	
D8NN8501TC		164.091
D8NN8501UA	D8NN8501UB	164.060
D8NN8501UB	D8NN8501UC	
D8NN8501UC		164.087
D8NN8505AB		164.063
D8NN8512AA		164.048
D8NN8512BA		164.054

NUMERO ORIGINALE NUMERO ORIGINAL ORIGINAL NUMBER	NUMERO SOSTITUTIVO REPLACE PAR NUMERO REPLACED BY NUMBER	RIFERIMENTO OMP REFERENCE OMP OMP REFERENCE
D8NN8530AA	D8NN8530AB	
D8NN8530AB		164.016
DHPN8A513A	EAPN8A513G	
DHPN8A513B	EAPN8A513G	
DHPN8A513C	DHPN8A513F	164.055
DHPN8A513F	EAPN8A513F	164.065
DJPN8A513C	EAPN8A513F	
DJPN8591A		162.147
DJPN8591B		162.148
E6NN8501AA	VEDI 164.185	
E6NN8501CA		164.113
E6NN8501DA	E6NN8501DB	
E6NN8501DB	E6NN8501DC	
E6NN8501DC		164.106
E6NN8505BA		164.104
E6NN8508BA		164.112
E6NN8513AA		164.108
E6NN8A513DA	E6NN8A513DB	
E6NN8A513DB	E6NN8A513DC	
E6NN8A513DC		164.107
E7NN8501EB		164.175
E7NN8501FB	E7NN8501FD	
E7NN8501FD	E7NN8501FE	
E7NN8501FE		164.096
E7NN8501GA	E7NN8501FB	
E7NN8A513CA	E7NN8A513CB	
E7NN8A513CB	E7NN8A513CE	
E7NN8A513CE		164.097
EAPN8A513B	EAPN8A513E	
EAPN8A513D	EAPN8A513E	
EAPN8A513E		164.092
EAPN8A513F		164.088
EAPN8A513G		164.093
EAPN8591A	EAPN8591D	
EAPN8591B	EAPN8591E	
EAPN8591C		162.149
EAPN8591D		162.200
EAPN8591E		162.207
FBPN8591A		162.156
FBPN8591B		162.157
EGPN8A513CA		164.114
EGPN8A513D	E6NN8A513DA	
EGPN8591CA		162.151
EGPN8591DA		162.150
EJPN8A513BA		164.185
EJPN8A513EB		164.180
EJPN8A513FB	E7NN8A513CA	

OGNI RIFERIMENTO ORIGINALE E' ASSOLUTAMENTE INDICATIVO. CHAQUE REFERENCE ORIGINAL EST ABSOLUMENT INDICATIVE. EVERY ORIGINAL PART NUMBER HAS TO BE CONSIDERED FOR REFERENCE PURPOSE ONLY.

TAVOLE DI CONVERSIONE  
TABLE DE CONVERSION  
CONVERSION TABLE

NEW HOLLAND

FORD



NUMERO ORIGINALE NUMERO ORIGINAL ORIGINAL NUMBER	NUMERO SOSTITUTIVO REPLACE PAR NUMERO REPLACED BY NUMBER	RIFERIMENTO OMP REFERENCE OMP OMP REFERENCE
EJPN8591AA		162.152
EJPN8591EB		162.153
EJPN8591FB		162.154
FONN8501CC		164.165
FONN8501DC		164.170
FAPN8A513GG	EGPN8A513D	
E1ADKN8501B	E1ADKN8501C	
E1ADKN8501C		164.010
E1ADKN8505B		164.038
E1ADKN8507A		164.041
E1ADKN8507B		164.042
E1ADKN8512		164.039
E1ADKN8530		169.066
E1ADKN8564		161.042
E1ADKN8567C		164.037
E1ADKN8576		164.043
E1ADKN8591		162.137
RIF. FINISH CODE NUMERO FINISH CODE FINISH CODE NUMBER	FINISH CODE SOSTITUTIVO REPLACE PAR NUMERO REPLACED BY NUMBER	RIFERIMENTO OMP REFERENCE OMP OMP REFERENCE
1711728	81711728	
1711772	81711772	
1863830	81863830	
1863835	81863835	
1863837	81863837	
1863898	81863898	
1863909	81863909	
1863921	81863921	
1863952	81863952	
1863983	81863983	
1863991	81863991	
1864001	81864001	
1866488	81866488	
1866491	81866491	
1869616	81869616	
1869617	81869617	
1872277	81872277	
1872282	81872282	
1872287	81872287	
1872289	81872289	
1872290	81872290	
1876233	81876233	
3914014	83914014	
3914015	83914015	
3926001		164.092
3926002		164.088
3926011		162.149
3926012	3956725	

RIF. FINISH CODE NUMERO FINISH CODE FINISH CODE NUMBER	FINISH CODE SOSTITUTIVO REPLACE PAR NUMERO REPLACED BY NUMBER	RIFERIMENTO OMP REFERENCE OMP OMP REFERENCE
3956722	1863837	
3956725	83956725	
3956729	83956729	
3961311	83961311	
3964038	1863909	
81711728		164.010
81711772		162.137
81863830		164.097
81863835		164.185
81863837		164.114
81863898		164.107
81863909		164.180
81863921		164.093
81863952		162.151
81863983		162.153
81863991		162.152
81864001		162.154
81866488		162.156
81866491		162.157
81869616		164.165
81869617	= 87800714	164.170
81872277		164.106
81872282	VEDI 164.093	
81872287		164.175
81872289		164.096
81872290	VEDI 164.185	
81876233		164.113
83914014		162.147
83914015		162.148
83956725		162.200
83956729		162.150
83961311		162.207
87790240		
87800490		
87800714	= 81869617	164.170

OGNI RIFERIMENTO ORIGINALE E' ASSOLUTAMENTE INDICATIVO. CHAQUE REFERENCE ORIGINAL EST ABSOLUMENT INDICATIVE. EVERY ORIGINAL PART NUMBER HAS TO BE CONSIDERED FOR REFERENCE PURPOSE ONLY.





SUITABLE

**NEW HOLLAND**

**FIAT ALLIS  
FIATHITACHI  
SIMIT**

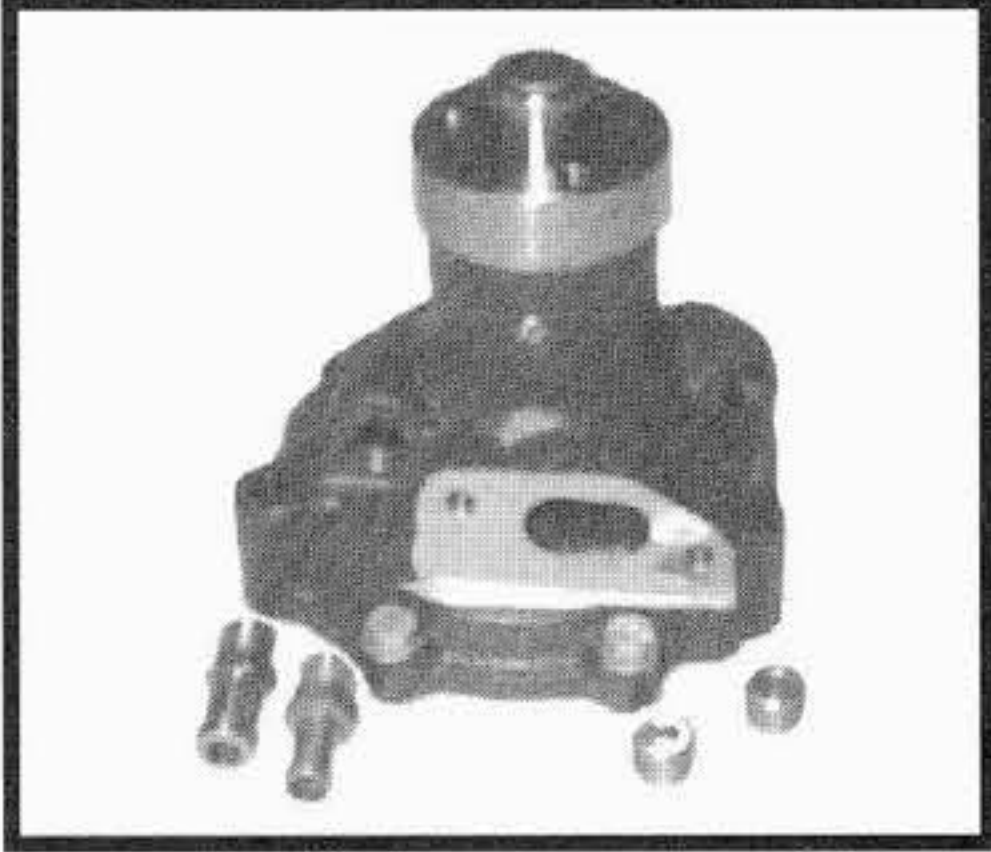
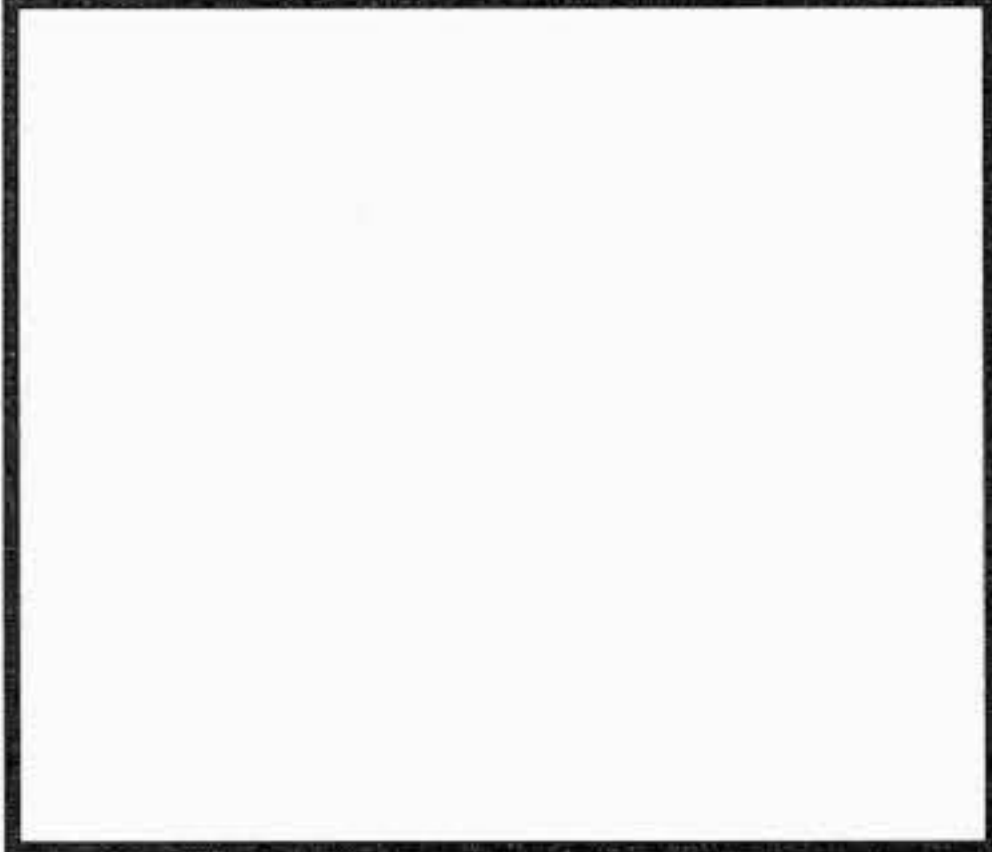
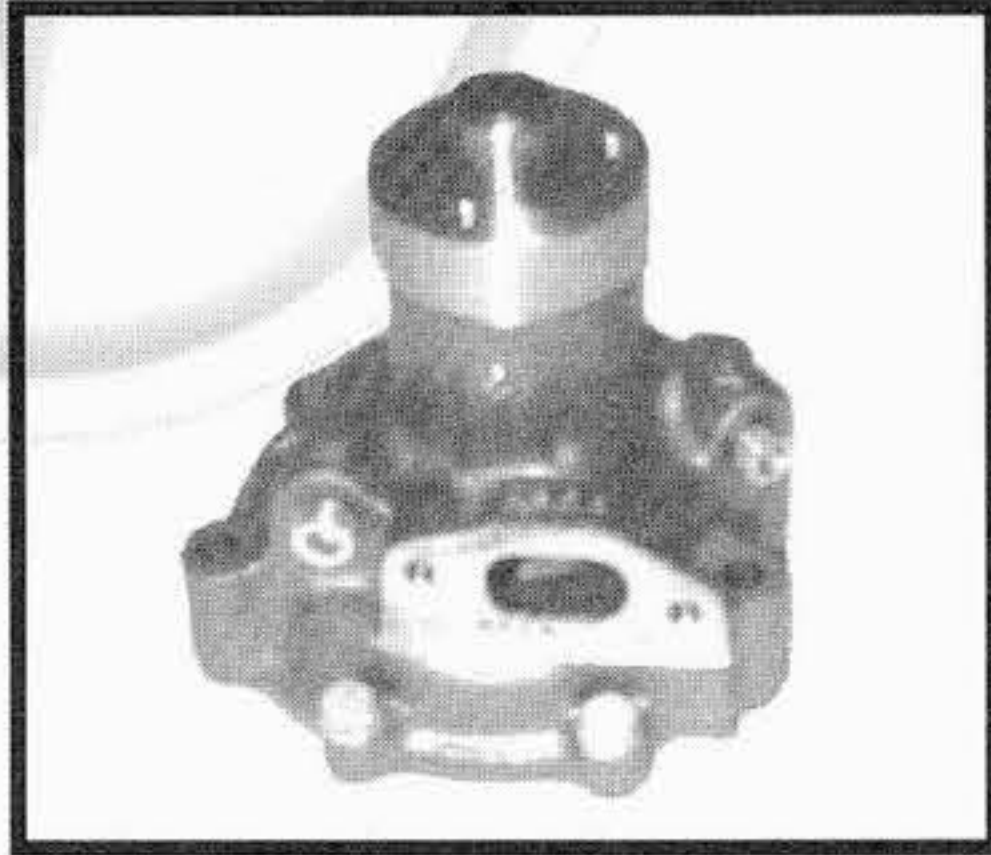

TIPO O MODELLO TYPE OU MODELE TYPE OR MODEL	MOTORE MOTEUR ENGINE	POMPA ACQUA POMPE A EAU WATER PUMP	KIT RIPARAZIONE NECESSAIRE DE REP. REPAIR KIT
		OMP REF. / O.EM. REF	OMP REF. / O.EM. REF
4 FL4 C - FL4 D - FL4 L FL4 M ---> fino al telaio 400456 FD5 - FL5 ---> fino al telaio 201360 FB7 - FB7 C.M. FD7 - FD7 B ---> fino al telaio 250904 FL7 ---> fino al telaio 250909 FR7 ---> fino al telaio 000440 FR9 ---> fino al telaio 00348 FR10 ---> fino al telaio 78Y00101 FE12 ---> fino al telaio 00124 FE12 LC ---> fino al telaio 00053 FE12 MLC ---> fino al telaio 00033 FE12 R ---> fino al telaio 00133 FR12 FE14 - FE16 FE16 ---> fino al telaio 00144 FE18 ---> fino al telaio 00480 FE18 LC ---> fino al telaio 00095 FE18 M ---> fino al telaio 00029 FE18 MLC ---> fino al telaio 00101 FE18 R - FE18 RM--> fino al telaio 00177 S60 FG65 A	8035.02.210/310 261/265/361/365 8035.04.265 8045.04.189 8045.04.293 8065.04.295 8065.04.295 8041 I 002 8051 I 000 8065.24.091 8041 I 002 all.004 8041.04.300 8065.24.092 8061 I 000 8061 I 000 8065.04.097 8065.24.098 8041 8041 I 002	196.319 93191101 	222.260 76029352 
FL4 M dal telaio 400457 ---> FD5 - FL5 dal telaio 201360 ---> FL5 B FB7 B FD7 - FD7 B dal telaio 250905 ---> FL7 dal telaio 250910 ---> - FL7 B FR7 dal telaio 000441 ---> FR7 B - FR7 C FD9 FR9 dal telaio 00349 ---> FD10 - FL10 E FR10 dal telaio 78Y00102 ---> FR10 B - FR10 C FR11 FE12 dal telaio 00125 ---> - FE12 L FE12 LC dal telaio 00054 ---> FE12 MLC dal telaio 00034 ---> FE12 R dal telaio 00134 ---> FE16 dal telaio 00145 ---> FE18 dal telaio 00481 ---> FE18 LC dal telaio 00096 ---> FE18 M dal telaio 00030 ---> FE18 MLC dal telaio 00102 ---> FA120 FH120 - FR130 FH150 - FH150 3B FH200-FH200 LC-FH200 3B-FH200 EI	8035.05.265 8045.05.389 8045.05.389 8045.05.393 8065.05.295 8065.05.295 8041 I 05 8045.05.395 8065.25.095 8051 I 05 8065.25.097 / 099 8065 SI 25.003 8065.05.290 8065.25.051-8060.25SI 8041 I 05 all.004 8051 I 05 all. 004 8065.05.097 8065.25.096 8045SI25 all.001 8045SI25 all.002 8065SI25 all.006	206.265 4813370 	222.264 1940105 



I ricambi non sono originali ma adattabili . Ogni riferimento originale é assolutamente indicativo .  
 Spare parts are not original but perfectly suitable . Every original part number has to be considered for reference purpose only .

SUITABLE

# NEW HOLLAND

FIAT ALLIS  
FIATHITACHI  
SIMIT

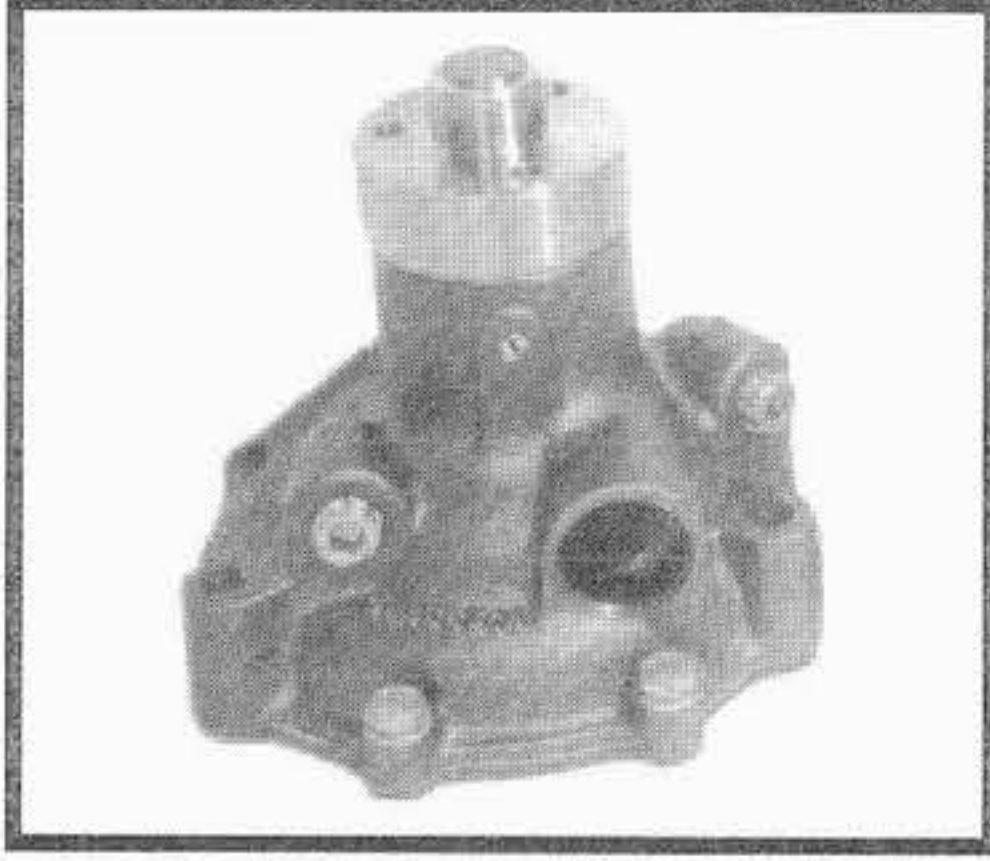

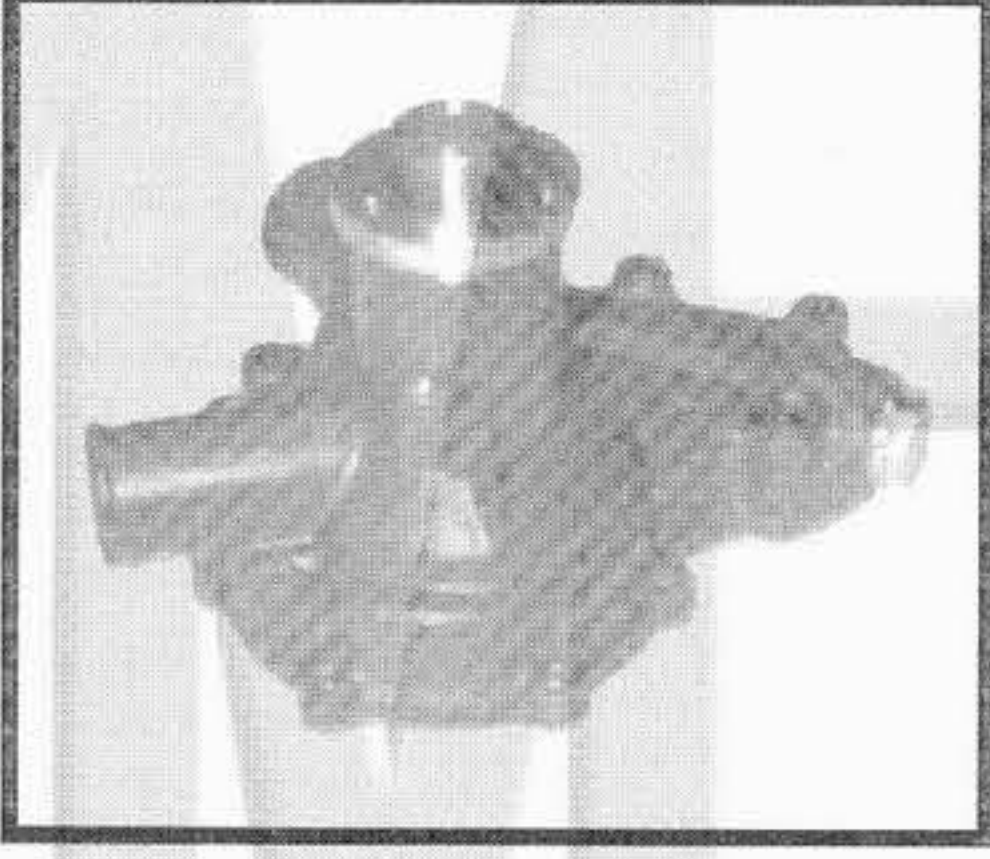
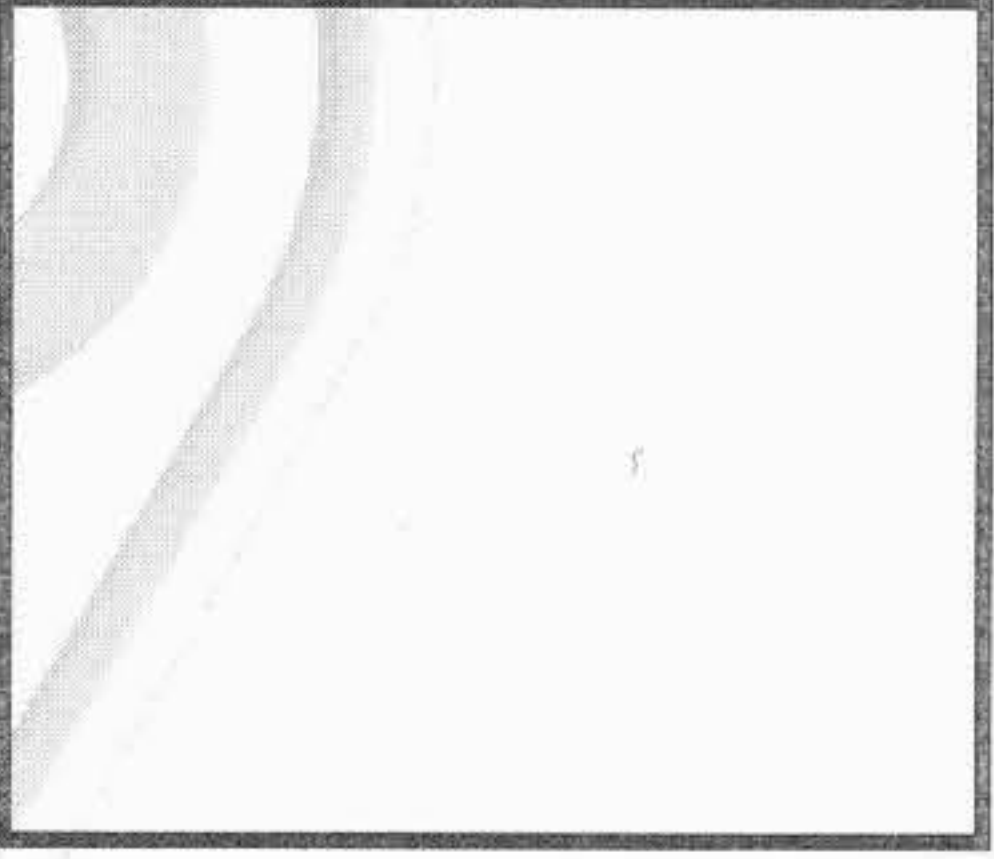
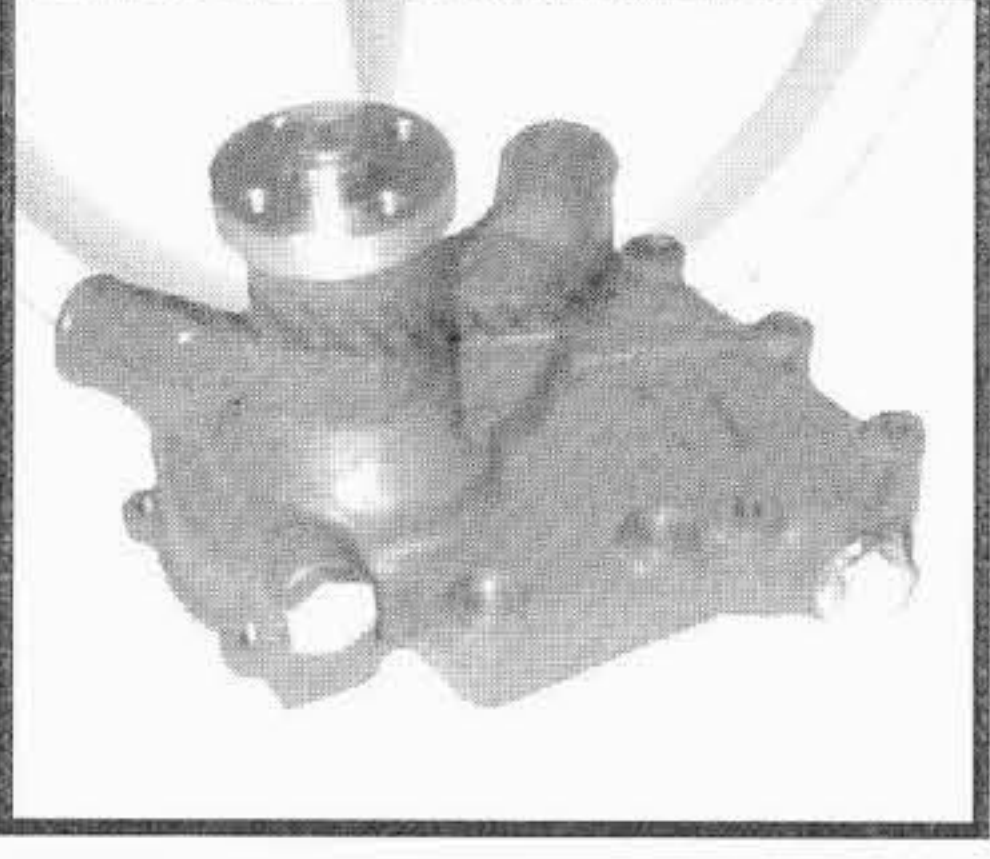
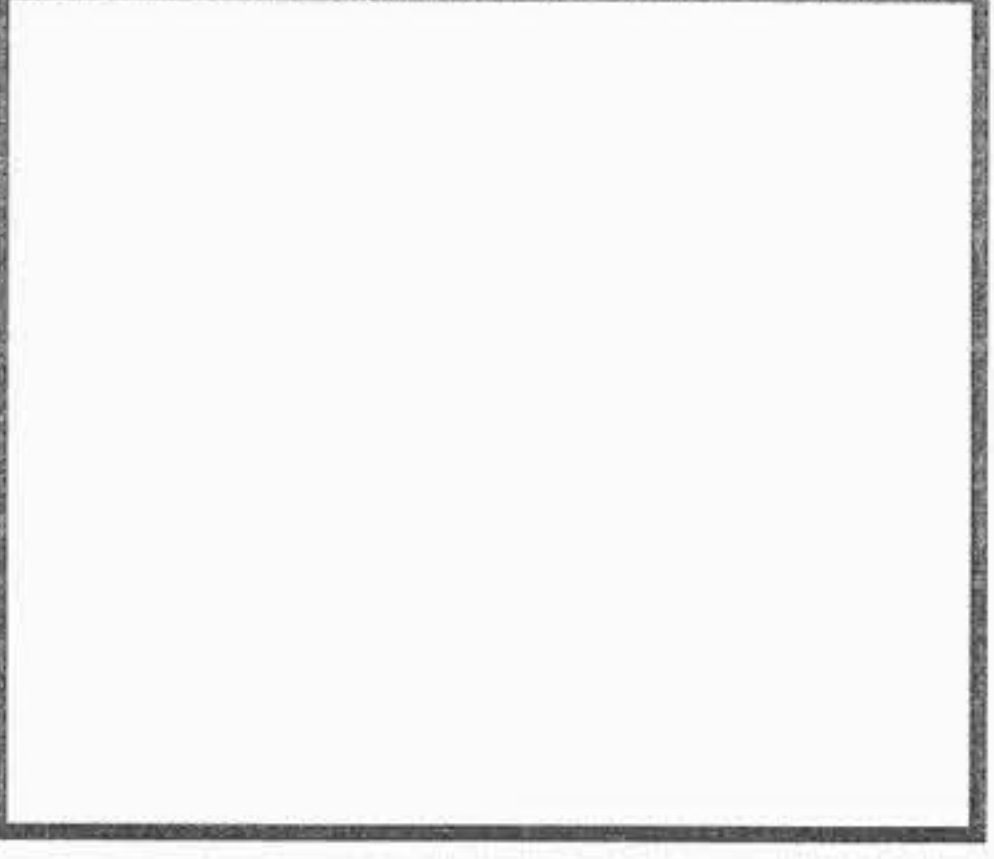
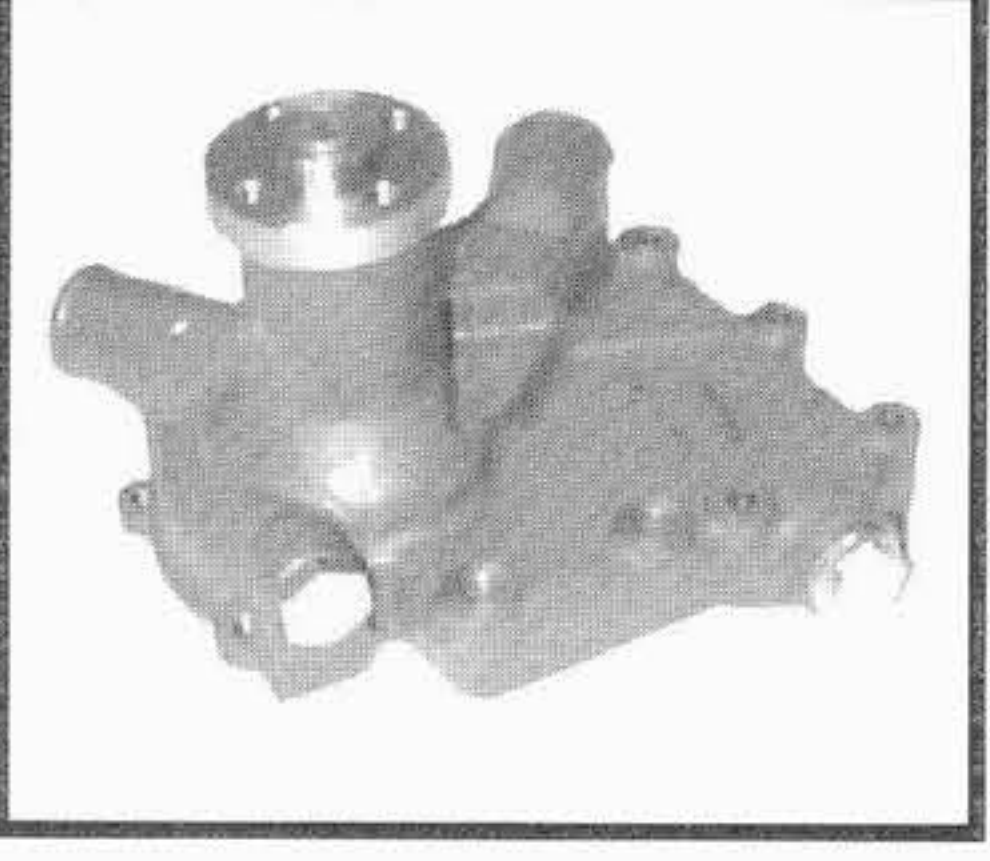
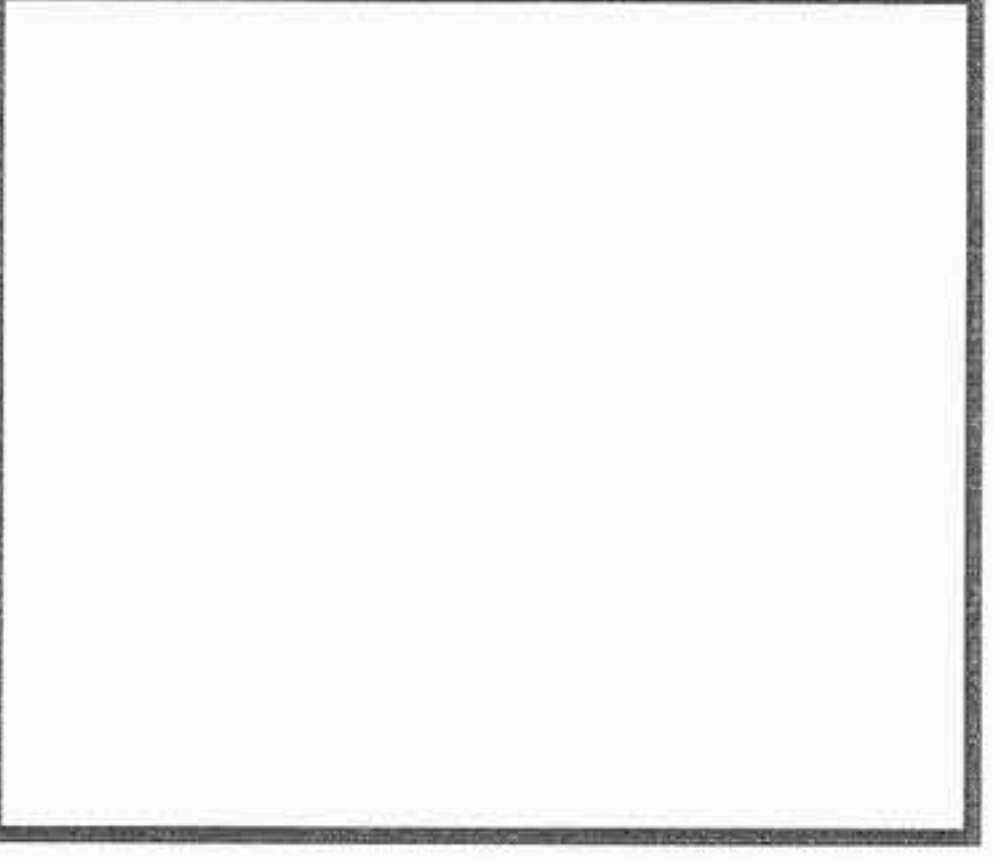
TIPO O MODELLO TYPE OU MODELE TYPE OR MODEL	MOTORE MOTEUR ENGINE	POMPA ACQUA POMPE A EAU WATER PUMP	KIT RIPARAZIONE NECESSAIRE DE REP. REPAIR KIT
		OMP REF. / O.EM. REF	OMP REF. / O.EM. REF
FL4 M FD5 - FL5 - FL5 B FB7 B FD7 - FD7 B - FL7 - FL7 B FR7 FR7 B - FR7 C FD9 FR9 FD10 - FL10 E FR10 FR10 B - FR10 C FR11 FE12 - FE12LC - FE12MLC - FE12L - FE12R FE16 FE18 - FE18 LC - FE18 M - FE18 MLC FA120 FH120 - FR130 FH150 - FH150 3B FH200 - FH200 LC - FH200 3B - FH200 EI tutti i modelli / all models 01 / 93 --->	8035.05.265 8045.05.389 8045.05.393 8065.05.295 8041 I 05 8045.05.395 8065.25.095 8051 I 05 8065.25.097 / 099 8065 SI 25.003 8065.05.290 8065.25.051-8060.25SI 8041 I 05 all.004 8051 I 05 all. 004 8065.05.097 8065.25.096 8045 SI 25 all. 001 8045 SI 25 all. 002 8065 SI 25 all. 006	<p><b>226.334</b> 98497117</p> 	<p><b>222.264</b> 1940105</p> 
5  FL6  S70 I - S70 M - SR70 - S90	CN3 var. 11 / .13  CO3/60 var.10/11/12  CO3/60	<p><b>221.485</b> 8829787</p> 	<p><b>222.262</b> 76031329</p> 
7 C  FL8 C  9	CO3.130MTvar.2/10  CO3.130MT  CP3/100 var. 3/4 var.13.300	<p><b>201.955</b> 4757340</p> 	<p><b>222.267</b> 76032963</p> 
7 D  S9 - SL9 - SR9  S11 - SL11	CO3.130MT var.14.300  CO3.130 var.2  CO3.130 var.2	<p><b>201.935</b> 4757341</p> 	<p><b>222.016</b> 79046187</p> 





I ricambi non sono originali ma adattabili . Ogni riferimento originale é assolutamente indicativo .  
 Spare parts are not original but perfectly suitable . Every original part number has to be considered for reference purpose only .

SUITABLE

**NEW HOLLAND**

**FIAT ALLIS  
FIATHITACHI  
SIMIT**

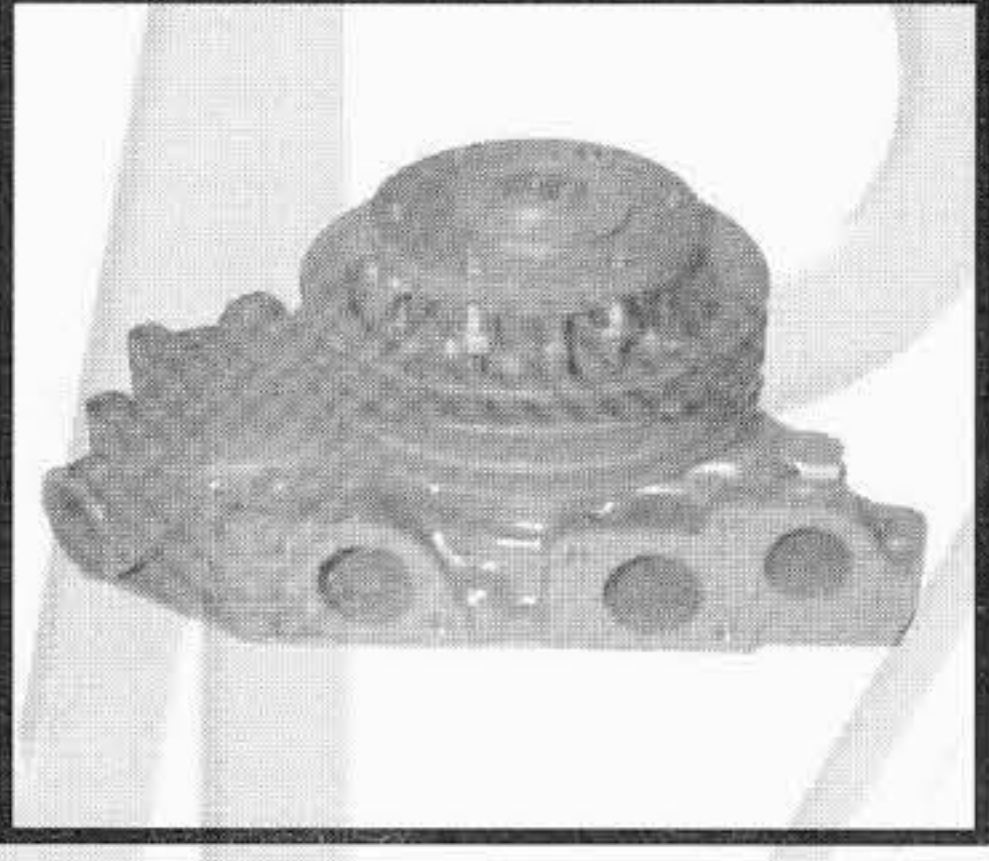
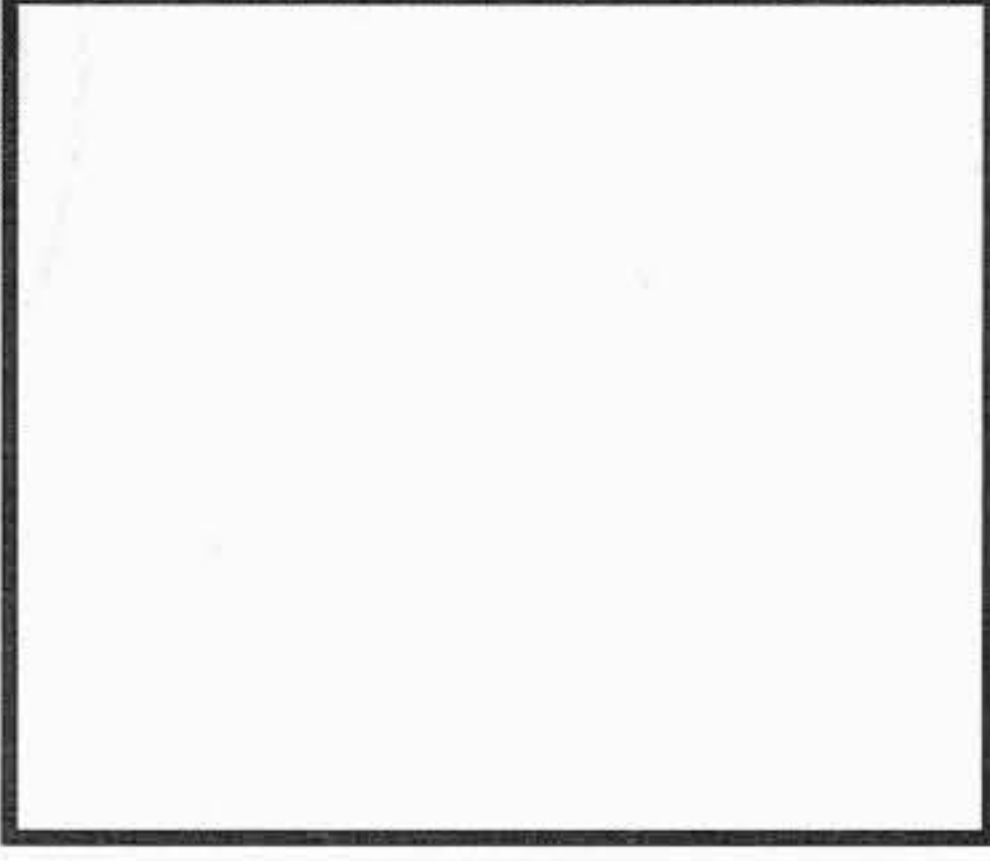
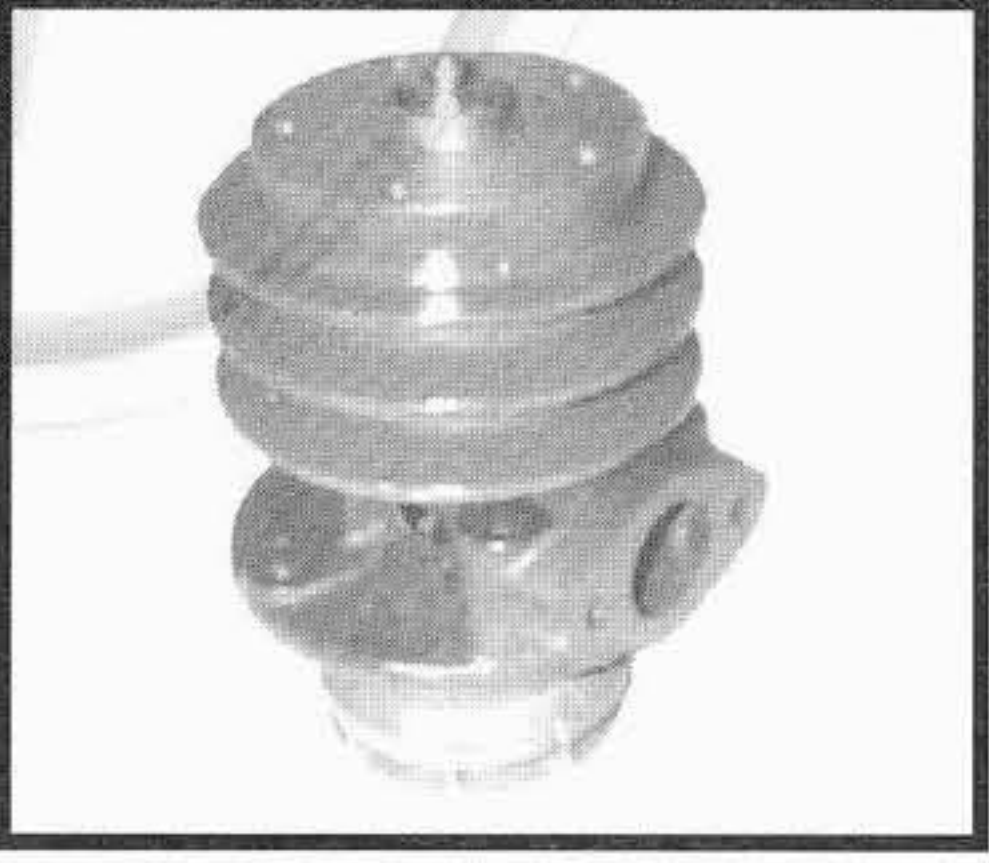

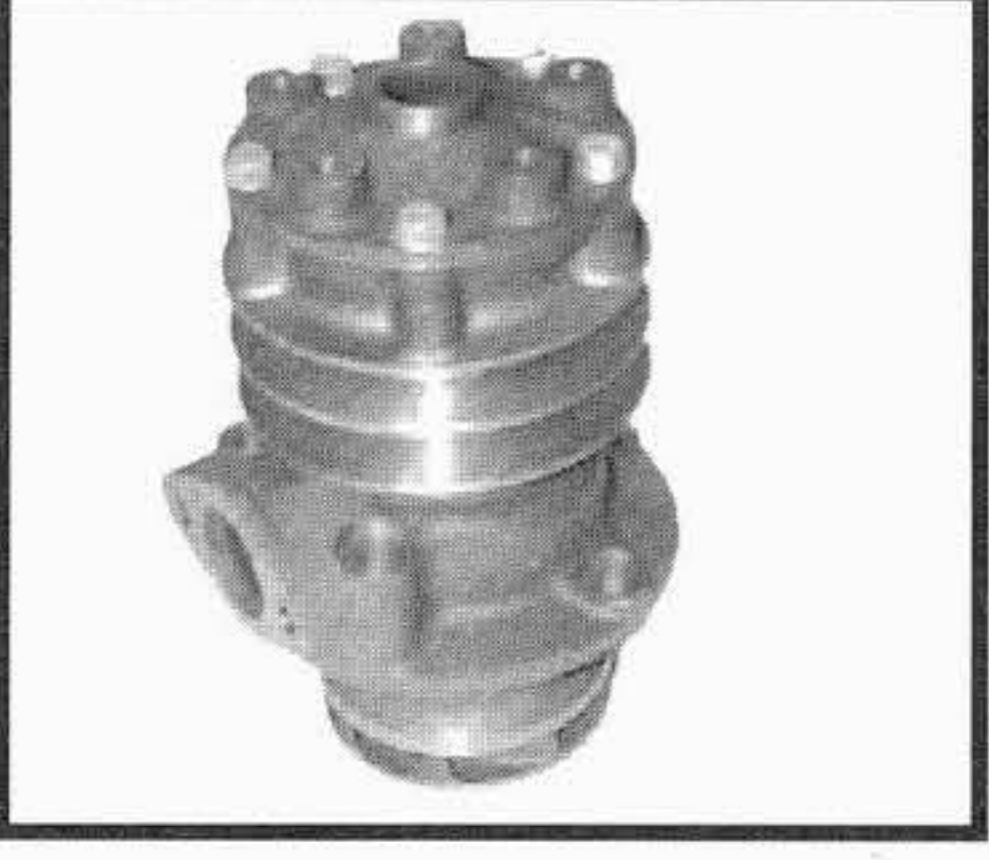
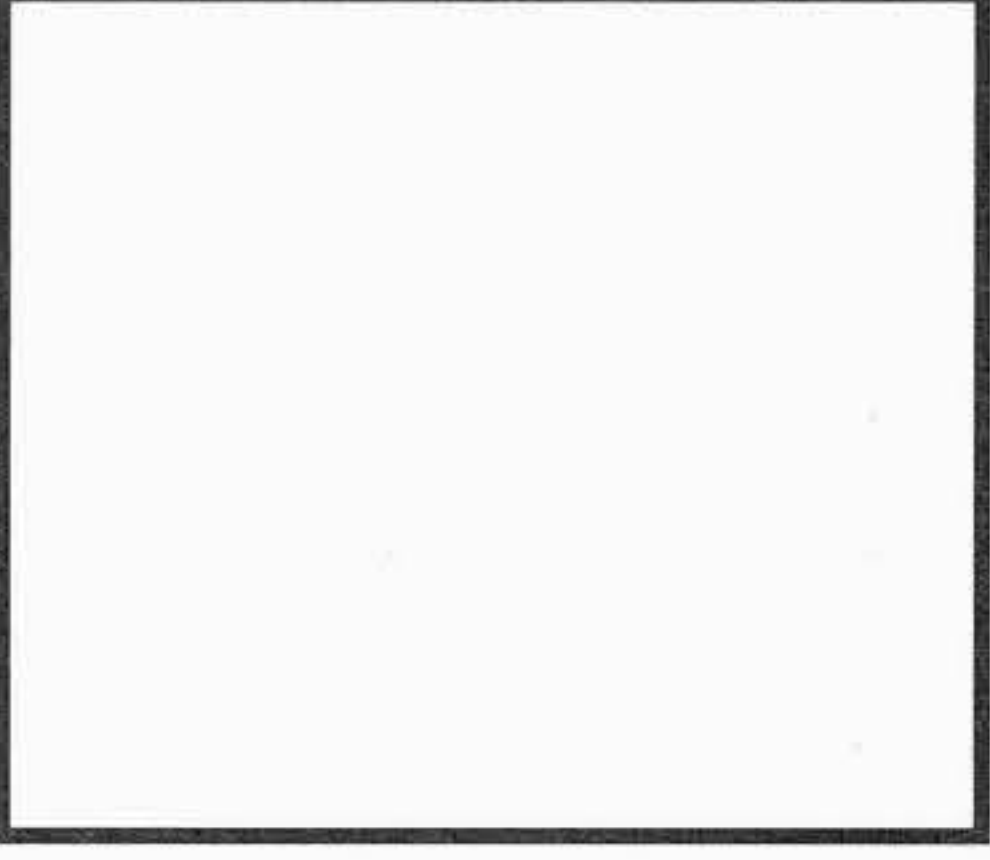
TIPO O MODELLO TYPE OU MODELE TYPE OR MODEL	MOTORE MOTEUR ENGINE	POMPA ACQUA POMPE A EAU WATER PUMP	KIT RIPARAZIONE NECESSAIRE DE REP. REPAIR KIT
		OMP REF. / O.EM. REF	OMP REF. / O.EM. REF
8 - 8 B  FL9  10 B  FL10 - FL10 B	CO3.130MT var.11 / .12  CO3.130MT var 1.300 / .800  CP3.100var.1/.2  CP3/100 - 300	<b>201.606</b> 8829780  	<b>202.271</b> 76032964  
8 B var. 300022071  FL9 var. 300022071	CO3.130MT var.11.800  CO3.130MT	<b>206.270</b> 4698554  	--- ---  
FL8	604.032/.033 --> fino al mot.084045	<b>201.590</b> 586017 CON PULEGGIA / WITH PULLEY    <b>201.585</b> --- SENZA PULEGGIA / WITHOUT PULLEY	<b>202.051</b> ---  
FL8	604.032 / .033 dal mot. 084046 -->	<b>201.596</b> 4629940 CON PULEGGIA / WITH PULLEY    <b>201.595</b> --- SENZA PULEGGIA / WITHOUT PULLEY	<b>222.056</b> 79046180  

I ricambi non sono originali ma adattabili . Ogni riferimento originale é assolutamente indicativo .  
Spare parts are not original but perfectly suitable . Every original part number has to be considered for reference purpose only .

SUITABLE







**NEW HOLLAND**

**FIAT ALLIS  
FIATHITACHI**

**Tel:+44(0)1925 850082 Fax: +(0)44 1925 850083**

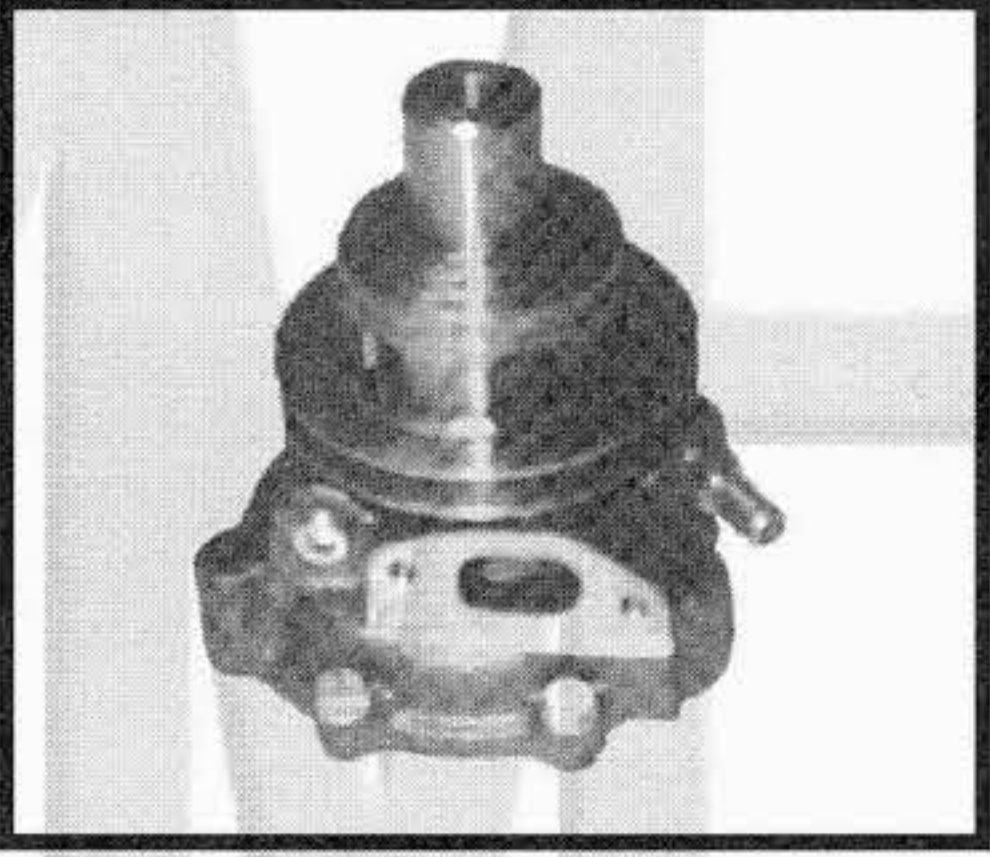
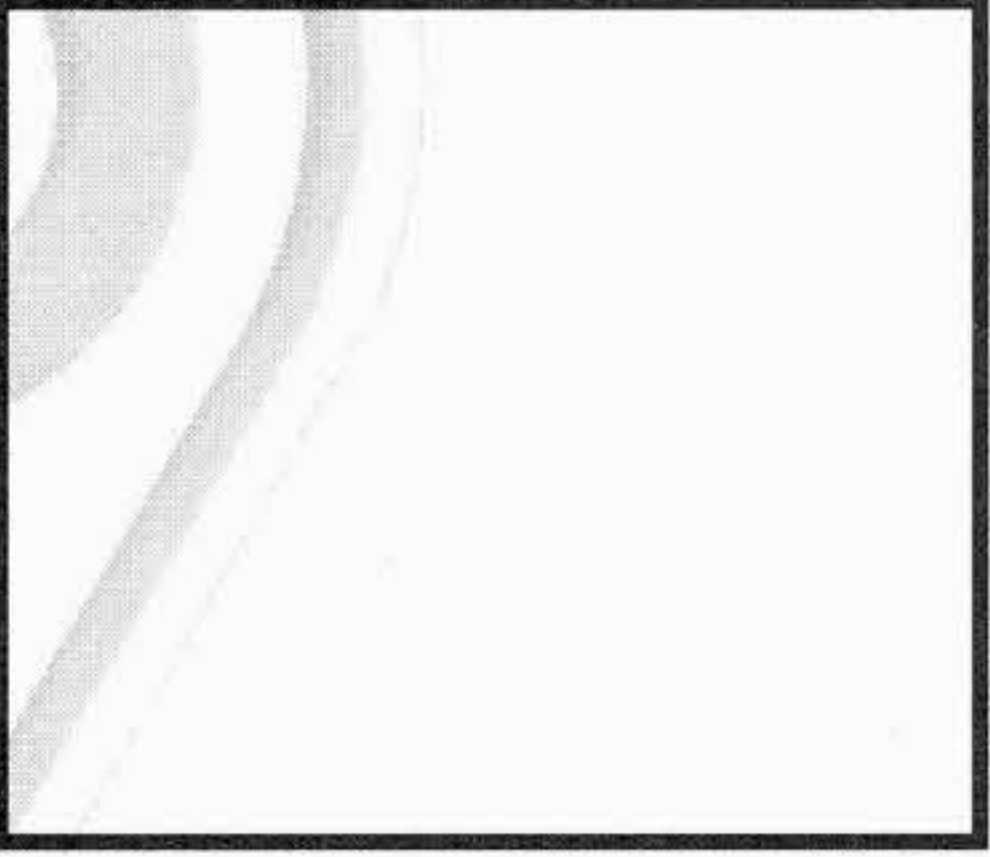
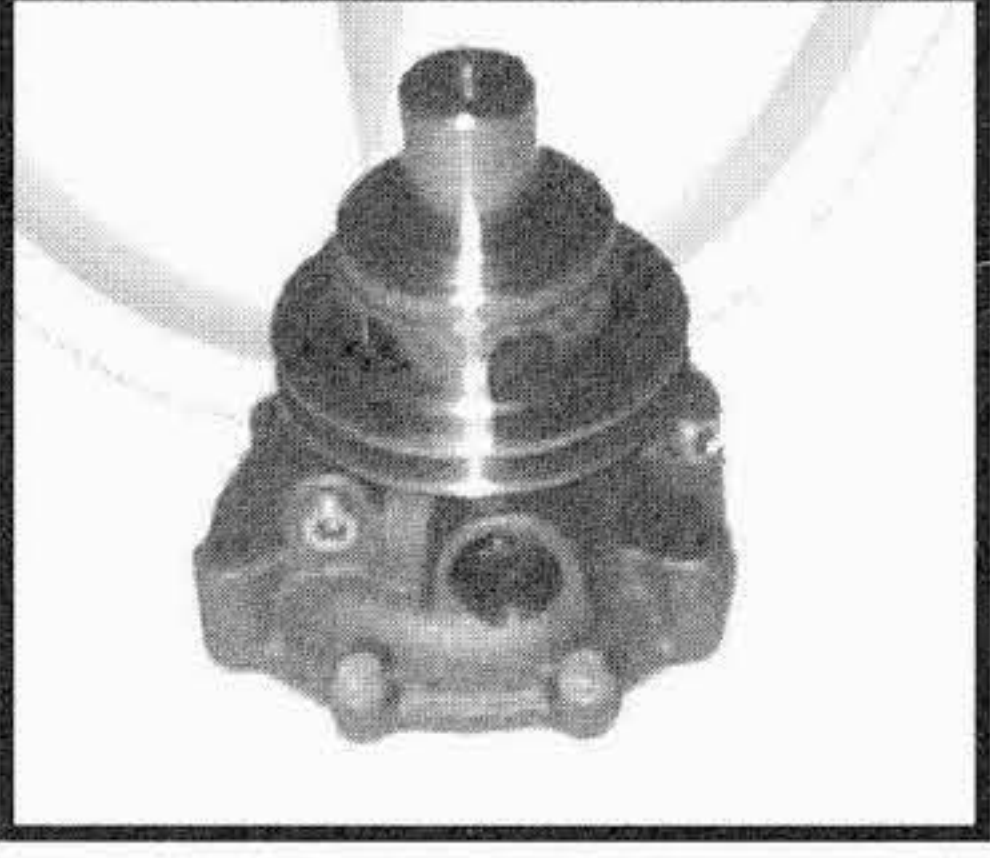
**www.spwaterpumps.co.uk**

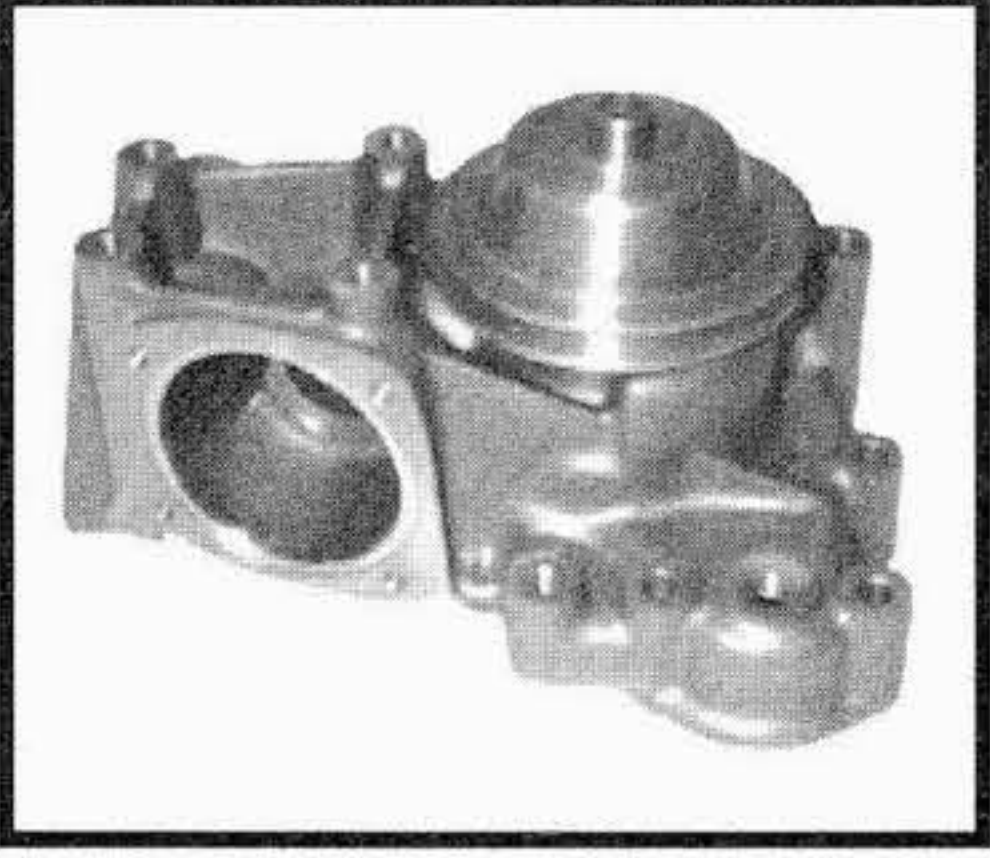







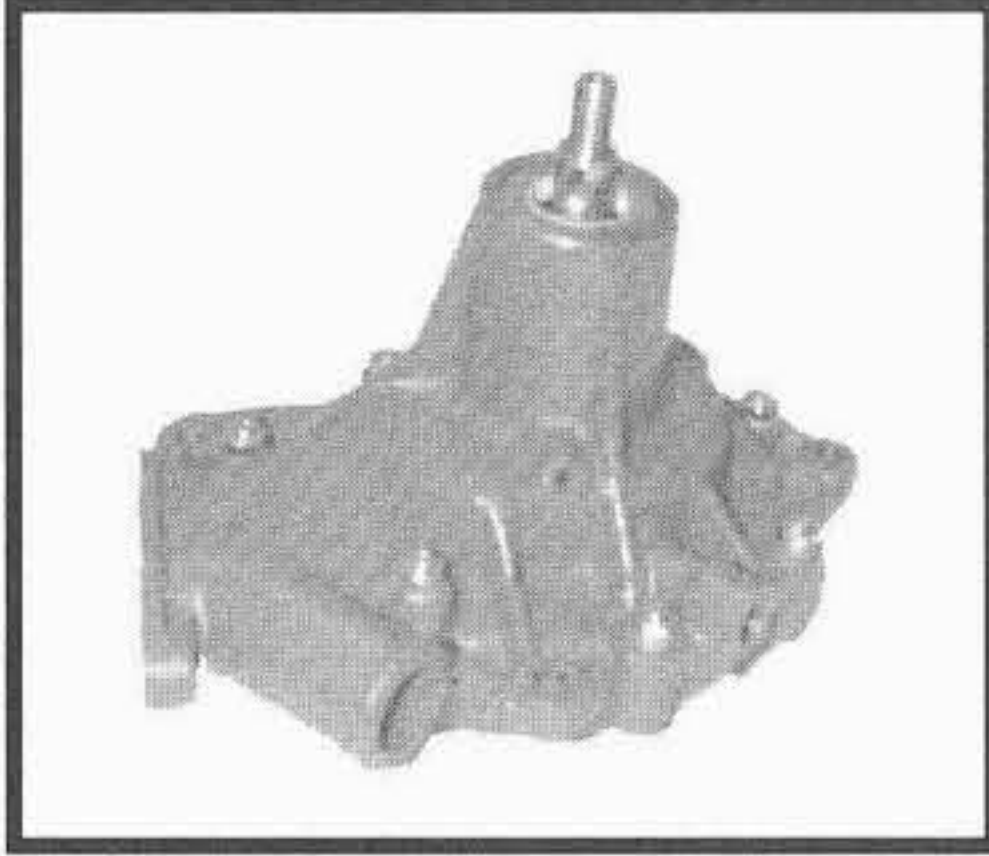

TIPO O MODELLO TYPE OU MODELE TYPE OR MODEL	MOTORE MOTEUR ENGINE	POMPA ACQUA POMPE A EAU WATER PUMP	KIT RIPARAZIONE NECESSAIRE DE REP. REPAIR KIT
		OMP REF. / O.EM. REF	OMP REF. / O.EM. REF
FR9 / B	CO3.130MT var. 20	<p><b>201.920</b> 8830732</p> 	<p><b>222.128</b> 79046181</p> 
FR9 B FR9 C --> 1996	8045.25.395	<p><b>206.380</b> 4817651</p> 	<p><b>222.253</b> ---</p> 
FR9 B FR9 C 1997 -->	8045.25.395	<p><b>226.551</b> 99454834</p> 	<p><b>222.253</b> ---</p> 
10 C - 10 CTA - 10 LGP FL10 C FD14 - FD14 E FL14 E FR15 - FR15 B FE20 / LC / HD / M / MLC / MHD FE24 FE28 / LC / HD / M / MLC / MHD FP40 FG75 - FG85 - FG95 FA150 FH220 - FH220 LC - FH220 3B FH300 - FH300 T	8365.05.570/573/577 8365.05.560 8365SI - 8365.25.541 8365.25.540 8365.580 / .583 8365.05.530 8365.05.531 8365.25.530/.531 8365.25.541 8365 8365.25.542/ 543 8365 SI 11 all.010 8365 SI 11 all.011	<p><b>206.435</b> 98410023</p> 	<p><b>222.263</b> 76030102</p> 

I ricambi non sono originali ma adattabili . Ogni riferimento originale é assolutamente indicativo .  
Spare parts are not original but perfectly suitable . Every original part number has to be considered for reference purpose only .

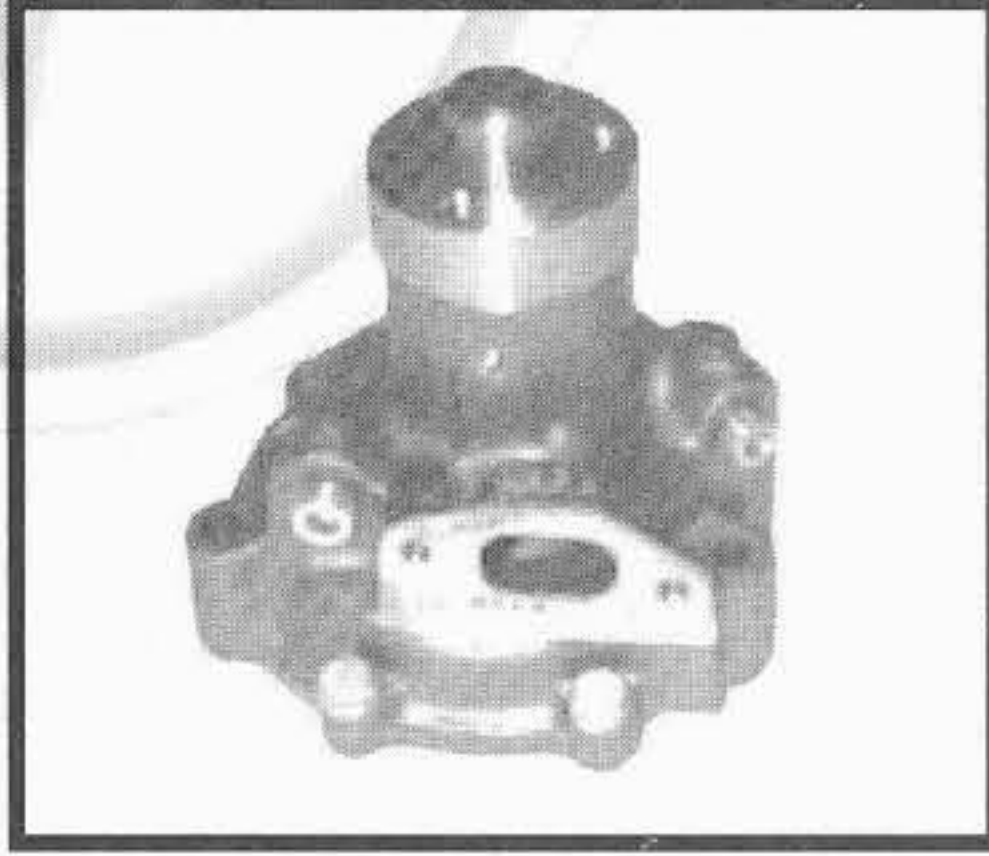
SUITABLE

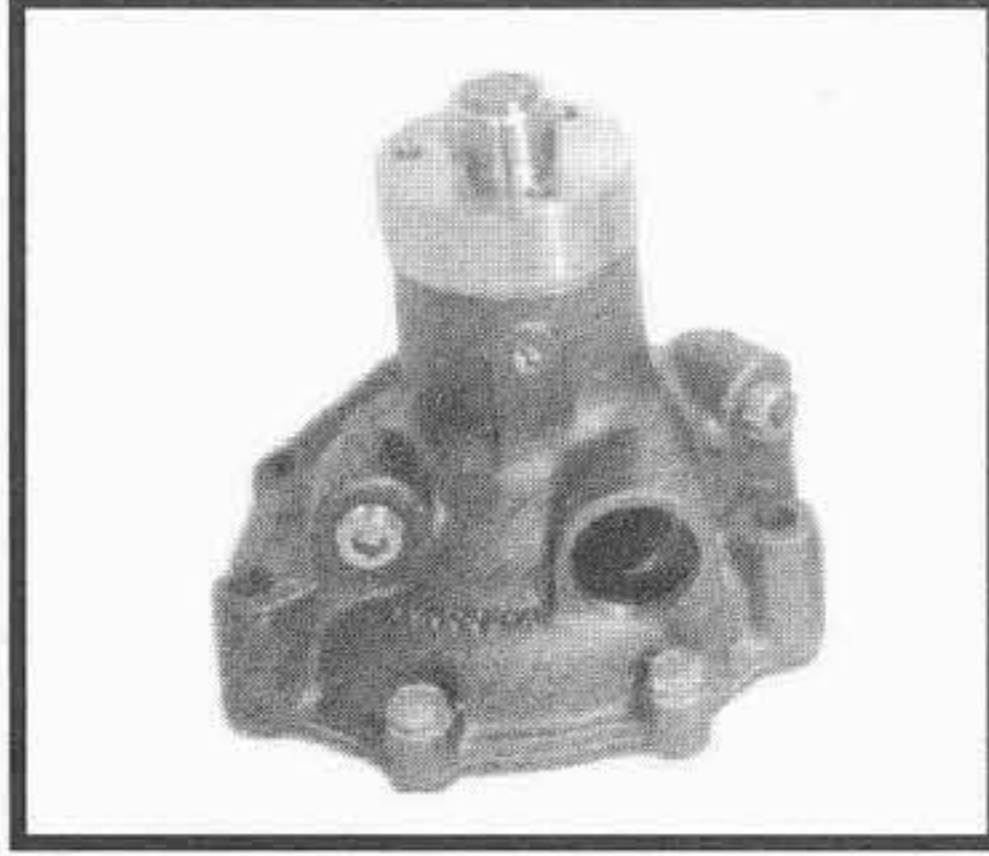
**NEW HOLLAND****FIAT ALLIS  
FIATHITACHI****Tel:+44(0)1925 850082 Fax: +(0)44 1925 850083****www.spwaterpumps.co.uk**

TIPO O MODELLO TYPE OU MODELE TYPE OR MODEL	MOTORE MOTEUR ENGINE	POMPA ACQUA POMPE A EAU WATER PUMP	KIT RIPARAZIONE NECESSAIRE DE REP. REPAIR KIT
FL12	220 ---> fino al mot. 0001558	<b>191.280</b> 4613395 	<b>192.012</b> --- 
FL12  AD-BD14 - AD14 L - BD14 - 14 B  FL14 - FL14 B  S15 B ---> fino alla matr. 24/159 S15 BHD ---> fino alla matr. 38/096 SLC15 B ---> fino alla matr. 29/022  20	8205.02 dal mot. 0001559 ---->  8205.02.511/.513  8205.02.500/.501  8205 I all. 005  8215.02.513/.515	<b>201.965</b> 4952496 	<b>202.270</b> 76031213 
FR12 B  FE18 R dal telaio 00178 ---> FE18 RM  <b>tutti i modelli / all models ---&gt; 12/92</b>	8065.25.092  8065.25.098	<b>206.295</b> 4813371 	<b>222.264</b> 1940105 
FR12 B  FE18 R dal telaio 00178 ---> FE18 RM  <b>tutti i modelli / all models 01/93 ---&gt;</b>	8065.25.092  8065.25.098	<b>226.338</b> 98497118 	<b>222.264</b> 1940105 

I ricambi non sono originali ma adattabili . Ogni riferimento originale é assolutamente indicativo .

Spare parts are not original but perfectly suitable . Every original part number has to be considered for reference purpose only .

SUITABLE





**NEW HOLLAND**

**FIAT ALLIS  
FIATHITACHI**

**Tel:+44(0)1925 850082 Fax: +(0)44 1925 850083**

**www.spwaterpumps.co.uk**

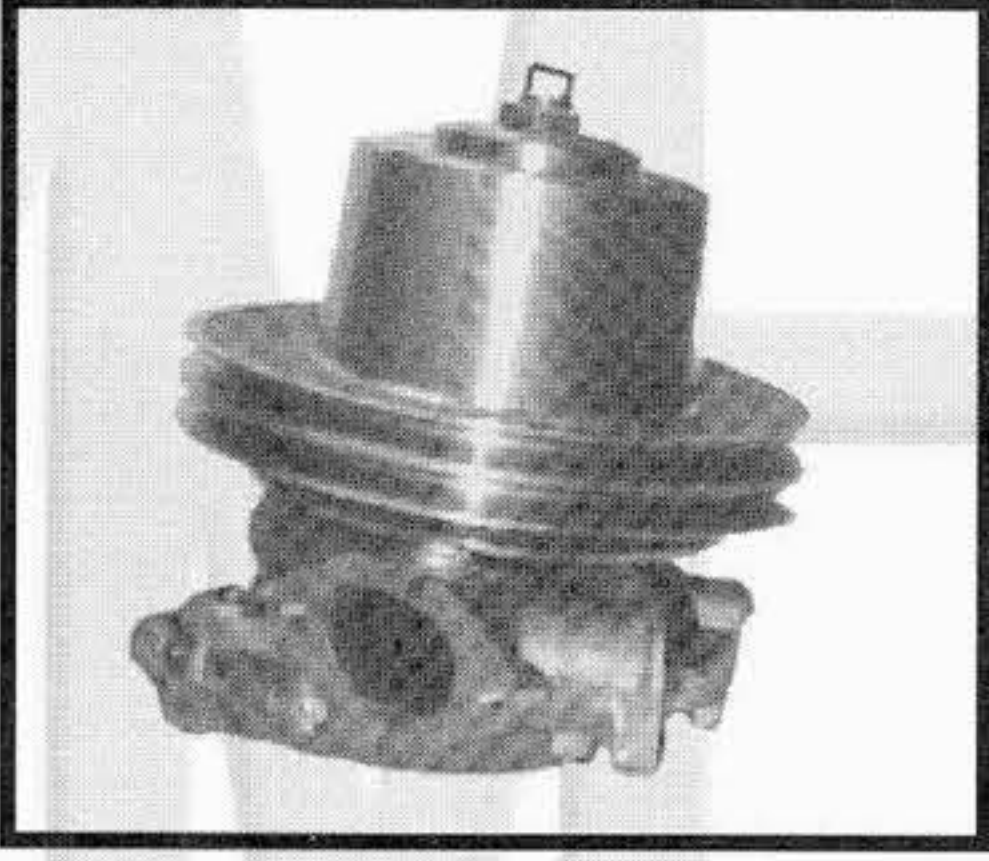
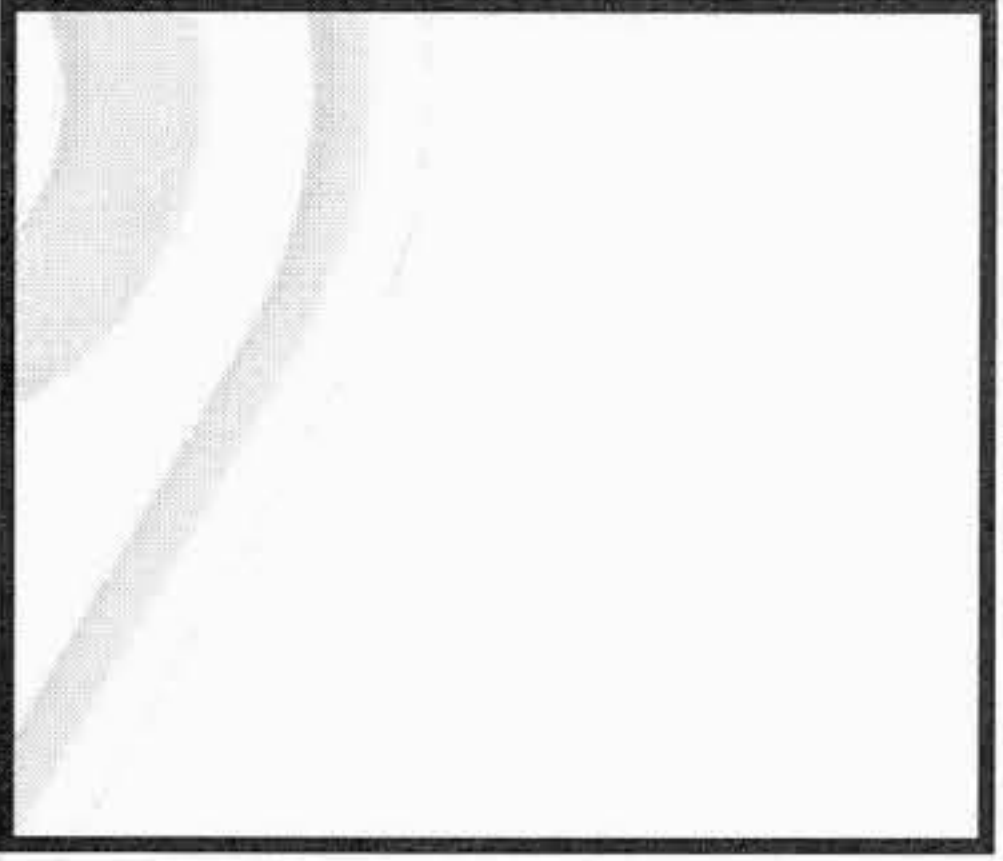

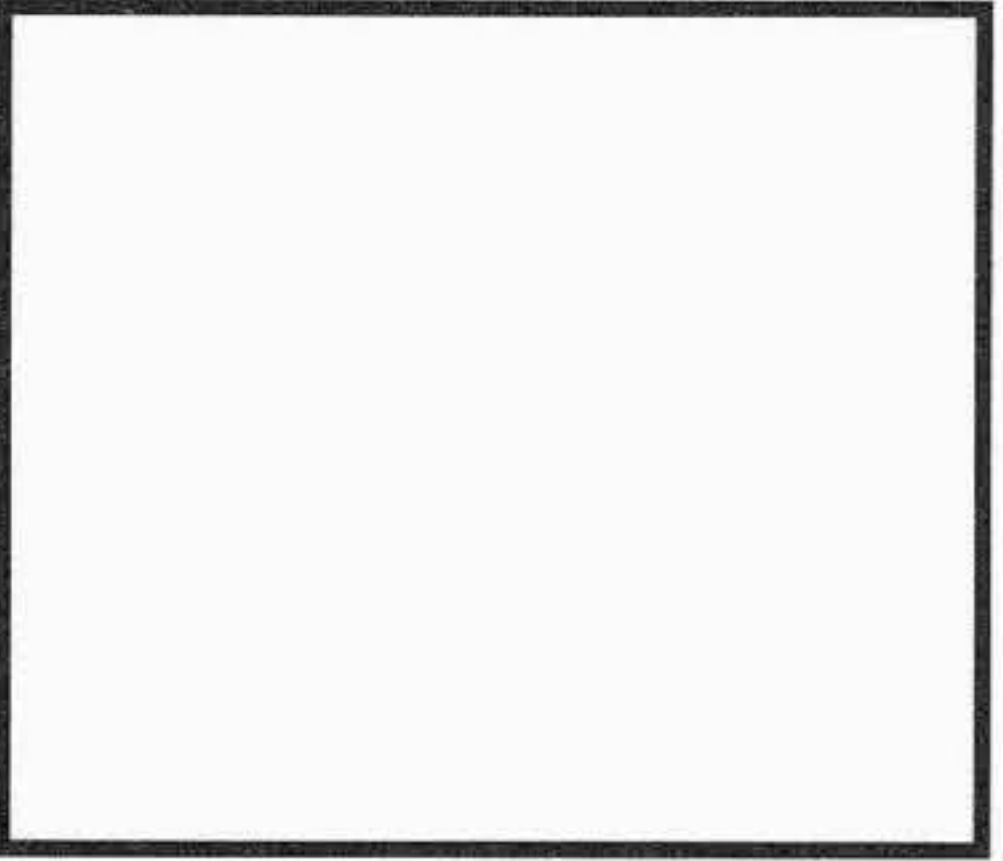
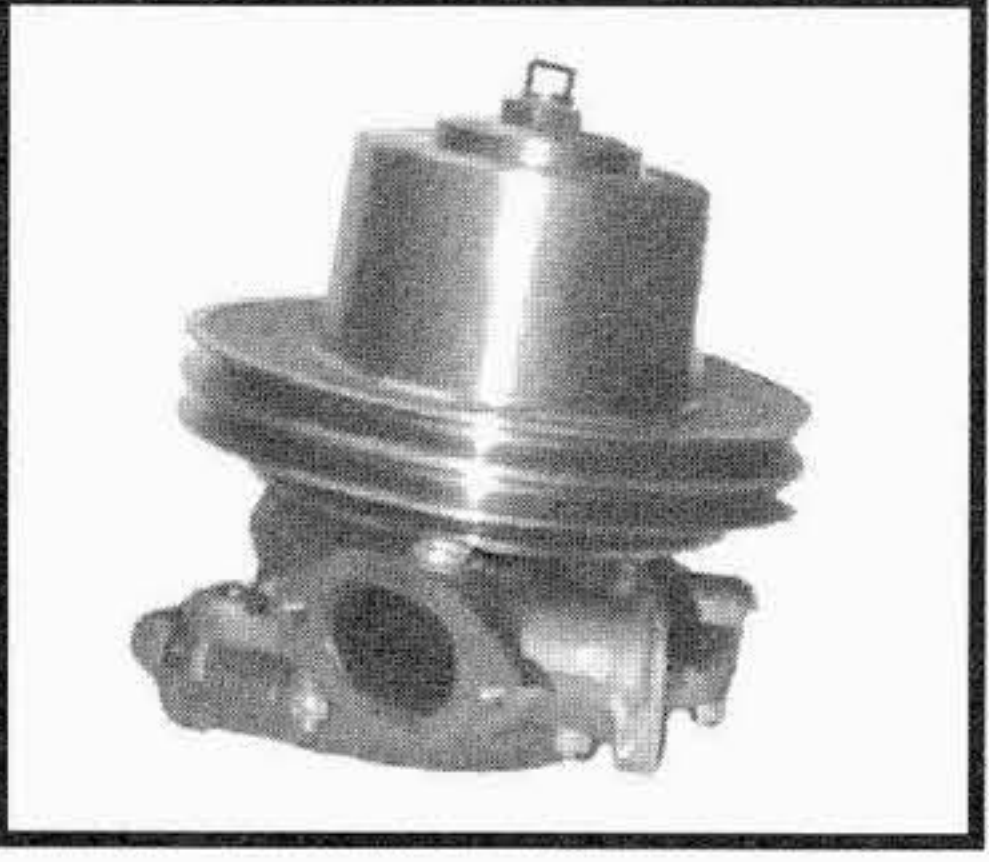
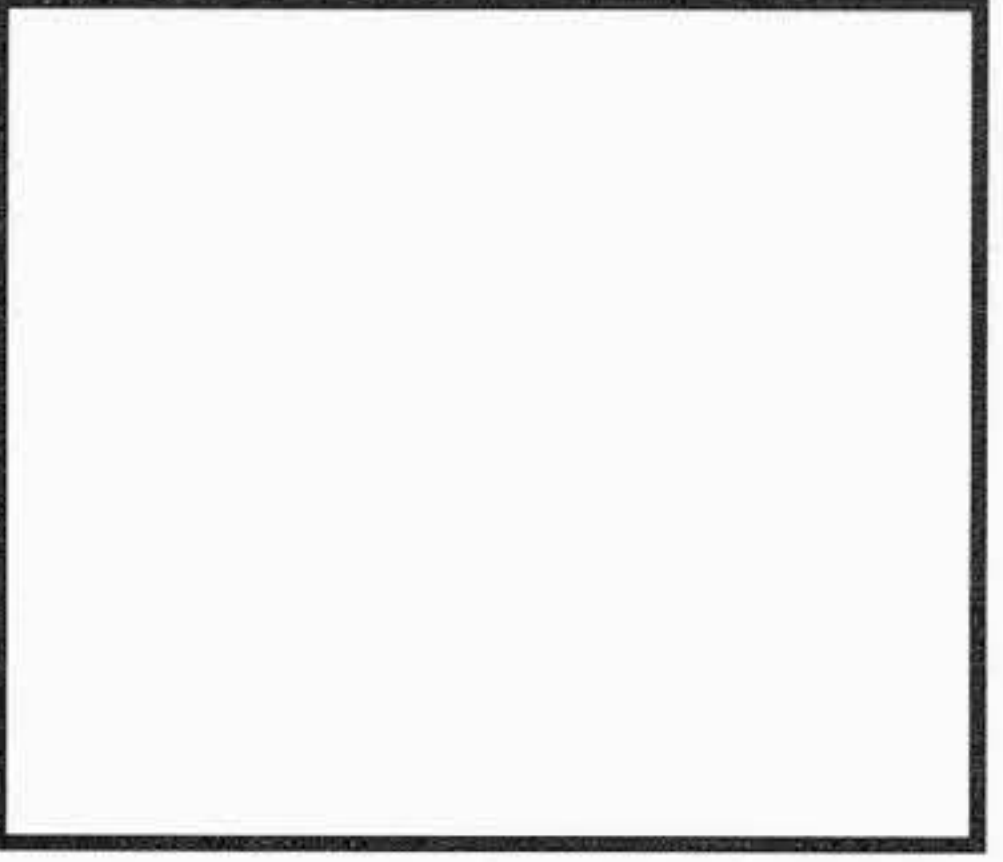
TIPO O MODELLO TYPE OU MODELE TYPE OR MODEL	MOTORE MOTEUR ENGINE	POMPA ACQUA POMPE A EAU WATER PUMP OMP REF. / O.EM. REF	KIT RIPARAZIONE NECESSAIRE DE REP. REPAIR KIT OMP REF. / O.EM. REF
14 C - 14 C LGP - 14 CTA  FL14 C  S15 B dalla matr. 24 / 160 ---> S15 BHD dalla matr. 38 / 097 ---> SLC15 B dalla matr. 29 / 023 --->  FD20  FL20	8205.02.513/.533  8205.02.520  8205 I all. 005  8215.22.520/.531 ---> fino al mot. 004274  8215.22.520 ---> fino al mot. 004274	201.960 79014642  	202.269 76032967  
FD20  FL20  FD20-2	8215.22.520/.531 dal mot. 004275 --->  8215.22.520 dal mot. 004275 --->  8215.22.520	201.975 4758190  	202.273 76032966  
FD14  FL14 D - FL14 D E.I.  FL20  FE40 - FE40 L - FE40 FS  FP40  FE45  FA200	8205.03.500/.531  8205.03.531  8215.22.520 dal mot. 007096 --->  8215.22.523  8205.03.531  8215 SI all.008  8215 I 006	206.010 4761615  	202.273 76032966  
FR20 - FR20 B	8215.02.542	201.985 4758191  	202.273 76032966  

I ricambi non sono originali ma adattabili . Ogni riferimento originale é assolutamente indicativo .  
 Spare parts are not original but perfectly suitable . Every original part number has to be considered for reference purpose only .

SUITABLE





# NEW HOLLAND

**FIAT ALLIS  
FIATHITACHI**

Tel: +44(0)1925 850082 Fax: +(0)44 1925 850083

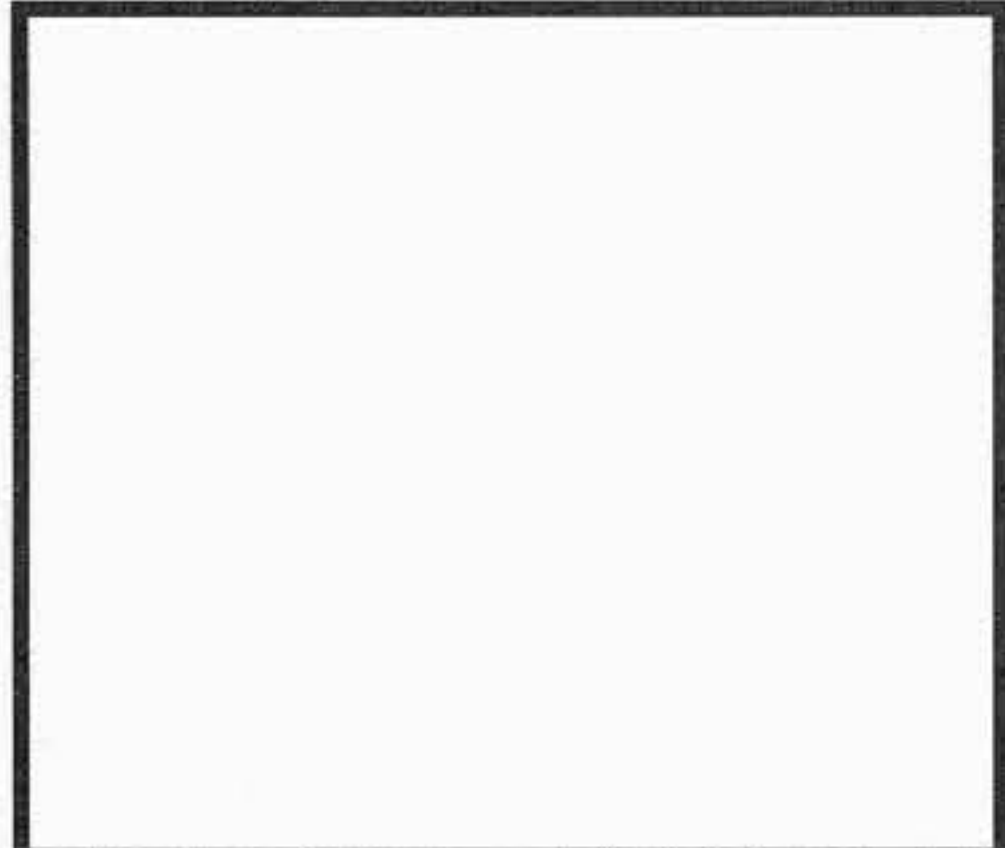
www.spwaterpumps.co.uk

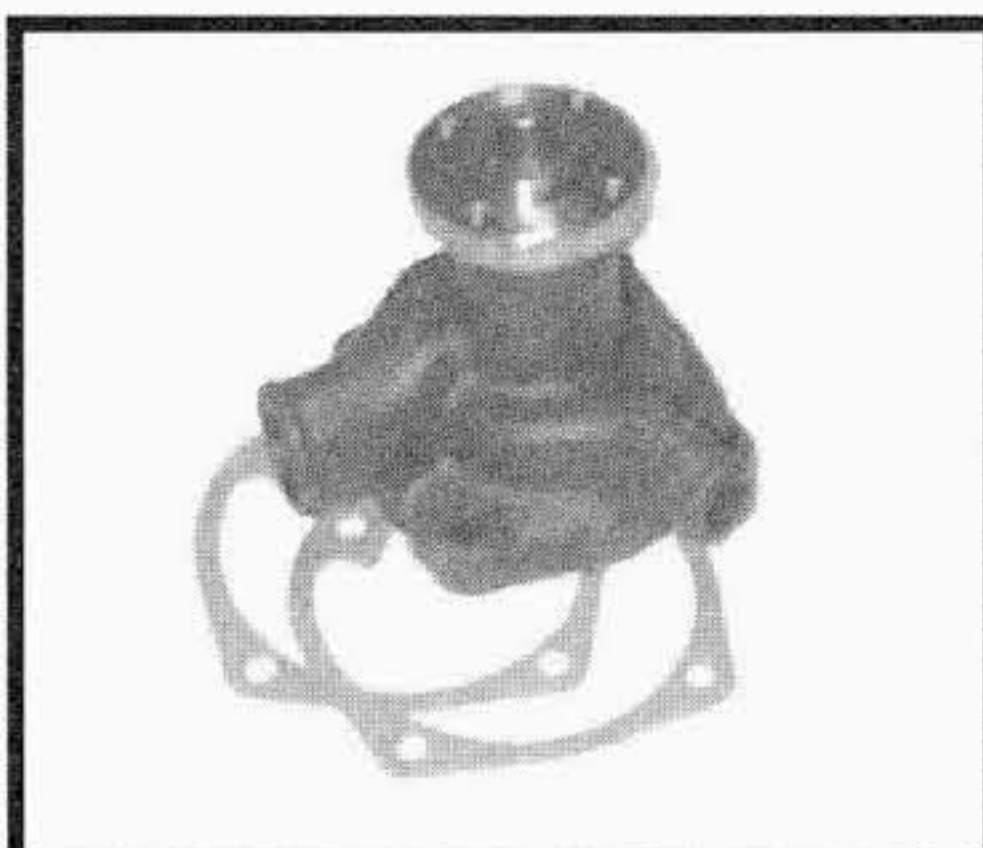
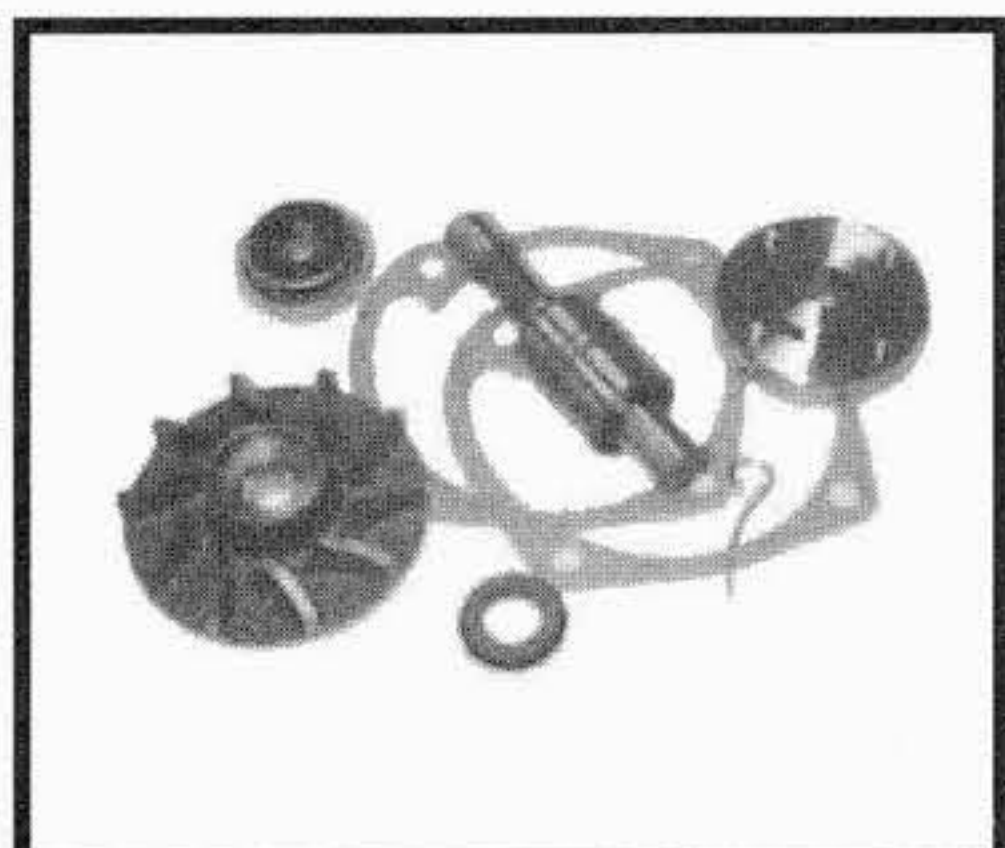

TIPO O MODELLO TYPE OU MODELE TYPE OR MODEL	MOTORE MOTEUR ENGINE	POMPA ACQUA POMPE A EAU WATER PUMP	KIT RIPARAZIONE NECESSAIRE DE REP. REPAIR KIT
		OMP REF. / O.EM. REF	OMP REF. / O.EM. REF
FD30 / HA / HUI / HSU / HR  FD30 B - FD30 C  FR35	8285  8285.22.004  8285	196.015 4764156  	202.272 76032965  
65 B	8065.04.089	196.327 4723063  	222.141 79046185  
65 B	8061105.000	206.205 8107660  	222.253 ---  
FA100	MWM D229 / 6cyl.	203.160 1756186  	202.090 ---  

I ricambi non sono originali ma adattabili . Ogni riferimento originale é assolutamente indicativo .  
Spare parts are not original but perfectly suitable . Every original part number has to be considered for reference purpose only .

SUITABLE



**NEW HOLLAND**

**FIAT ALLIS  
FIATHITACHI**

**Tel: +44(0)1925 850082 Fax: +(0)44 1925 850083**

**www.spwaterpumps.co.uk**

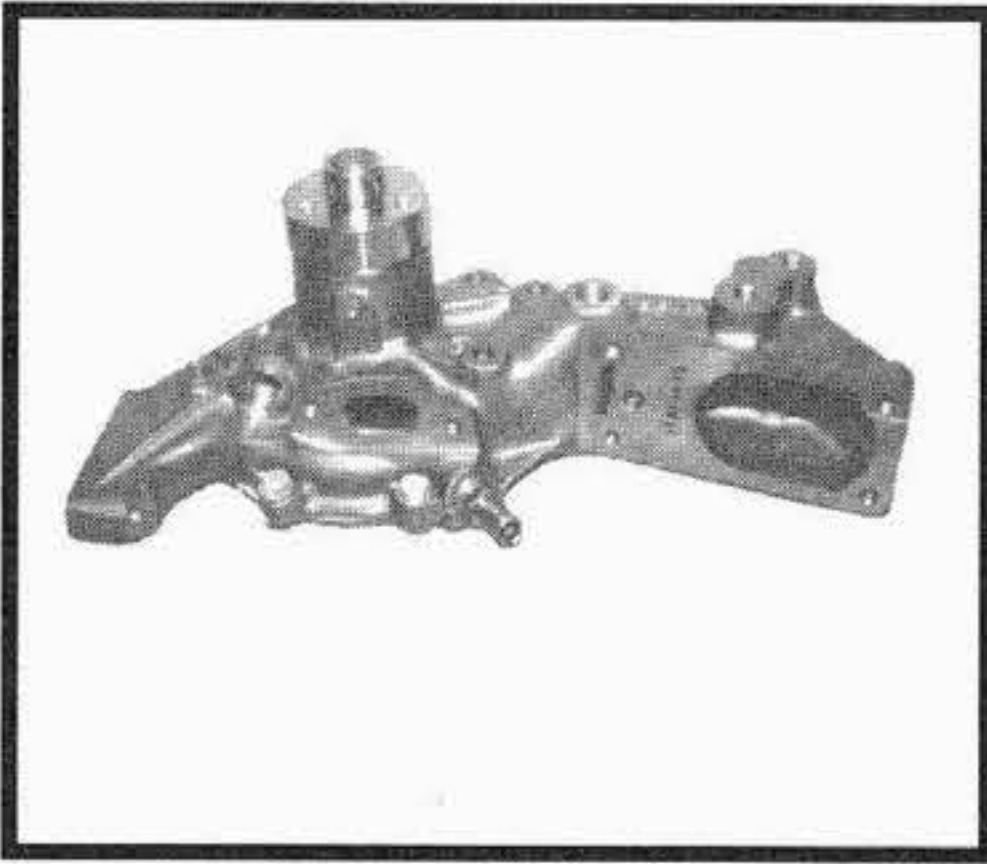
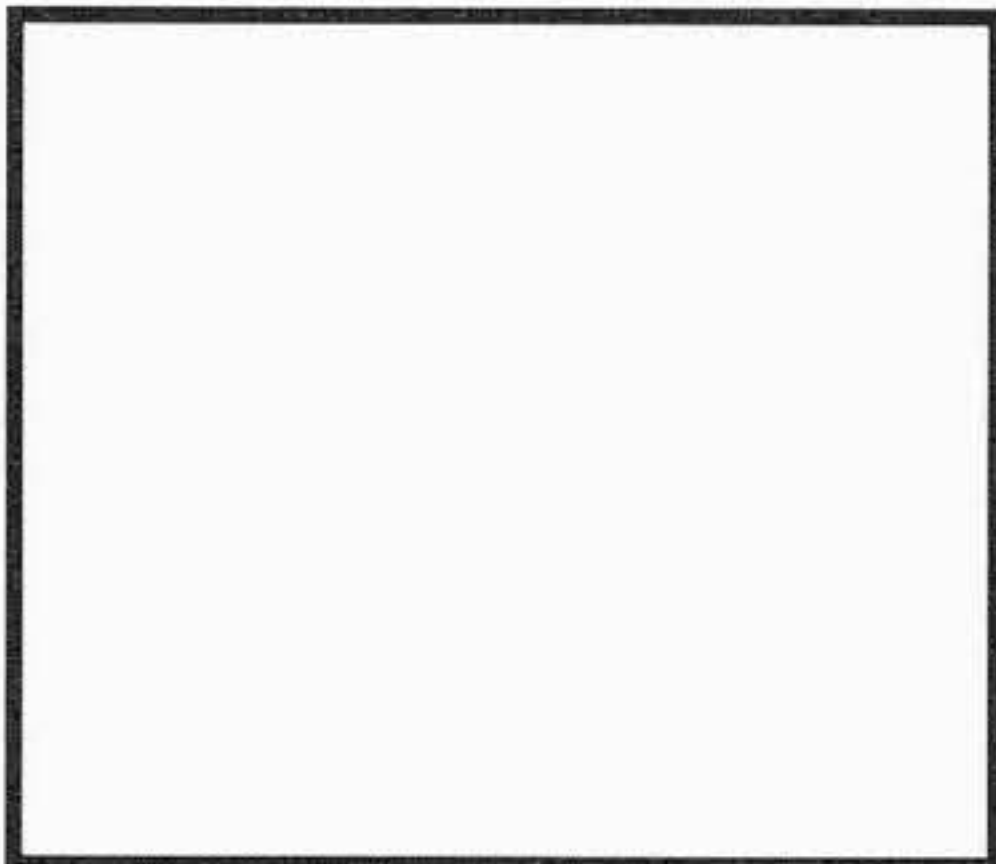
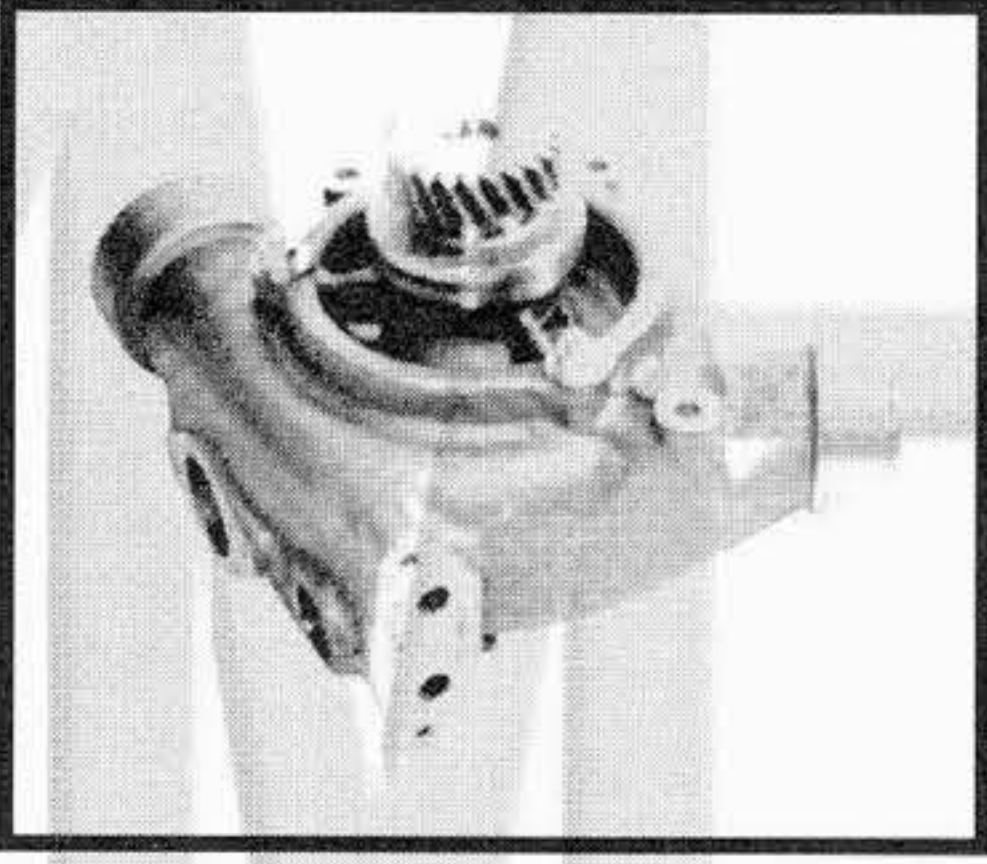
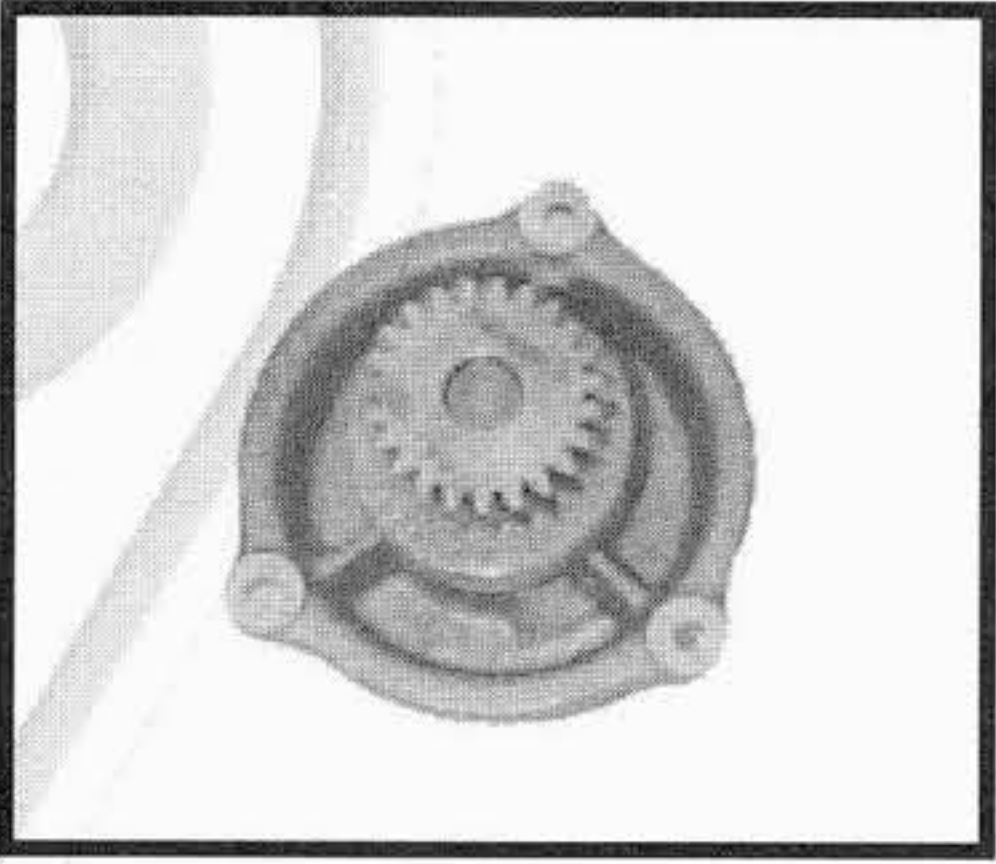

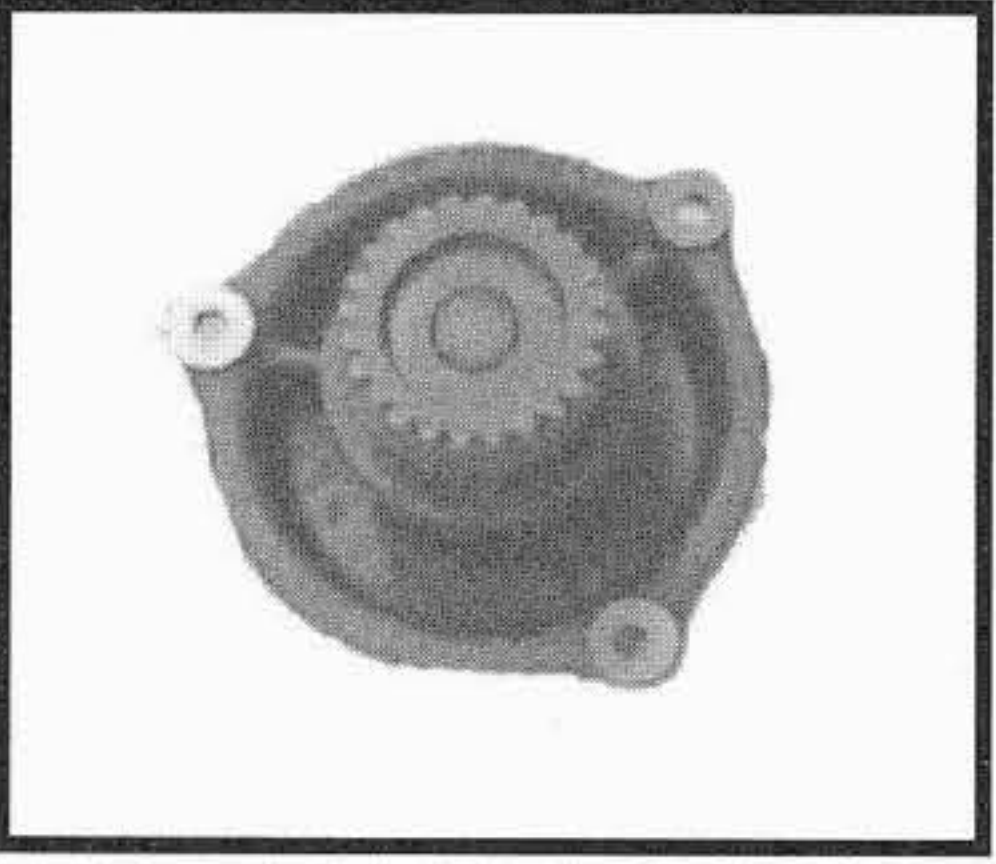
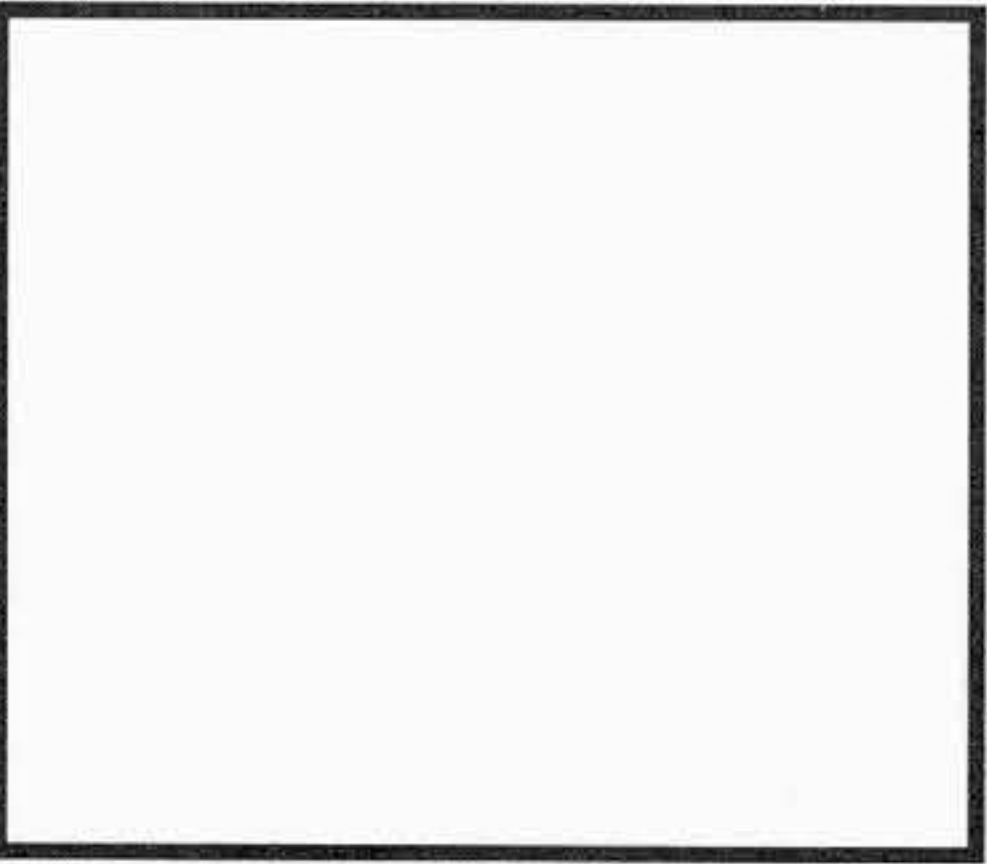
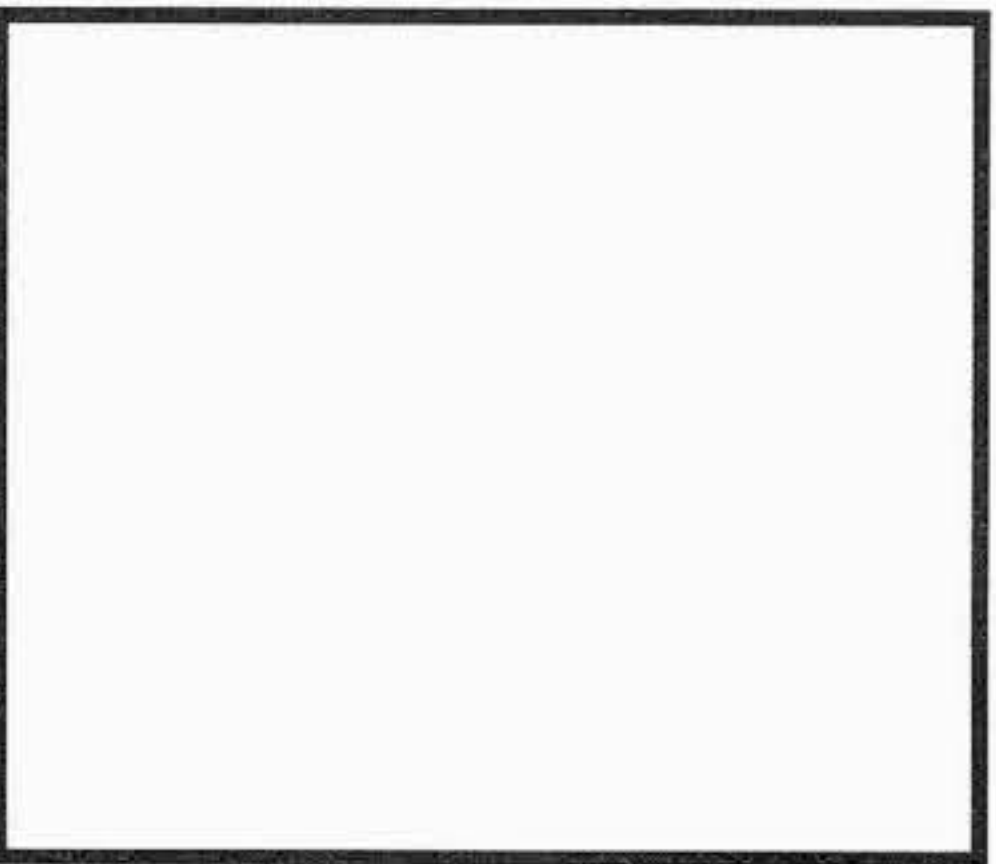
TIPO O MODELLO TYPE OU MODELE TYPE OR MODEL	MOTORE MOTEUR ENGINE	POMPA ACQUA POMPE A EAU WATER PUMP	KIT RIPARAZIONE NECESSAIRE DE REP. REPAIR KIT
FH150 W  FH150 WT	8045SI25 all.003	<p><b>196.341</b> 98497114</p> 	<p><b>192.266</b> ---</p> 
FR220	8465.21	<p><b>196.450</b> 61315464</p>  <p><b>INGRANAGGIO / GEAR</b></p>	<p><b>196.251</b> 93190288</p>  <p><b>Ø = 62,5 mm N° denti = 23</b></p>
FH400  FH400	8215.22.400  8215.42	<p><b>196.437</b> 99456317</p>  <p><b>INGRANAGGIO / GEAR</b></p>	<p><b>196.446</b> 42530032</p>  <p><b>Ø = 63 mm N° denti = 24</b></p>
			

I ricambi non sono originali ma adattabili . Ogni riferimento originale é assolutamente indicativo .  
Spare parts are not original but perfectly suitable . Every original part number has to be considered for reference purpose only .



SUITABLE

**NEW HOLLAND BENATI - FIATHITACHI**



Tel: +44(0)1925 850082 Fax: +(0)44 1925 850083

www.spwaterpumps.co.uk

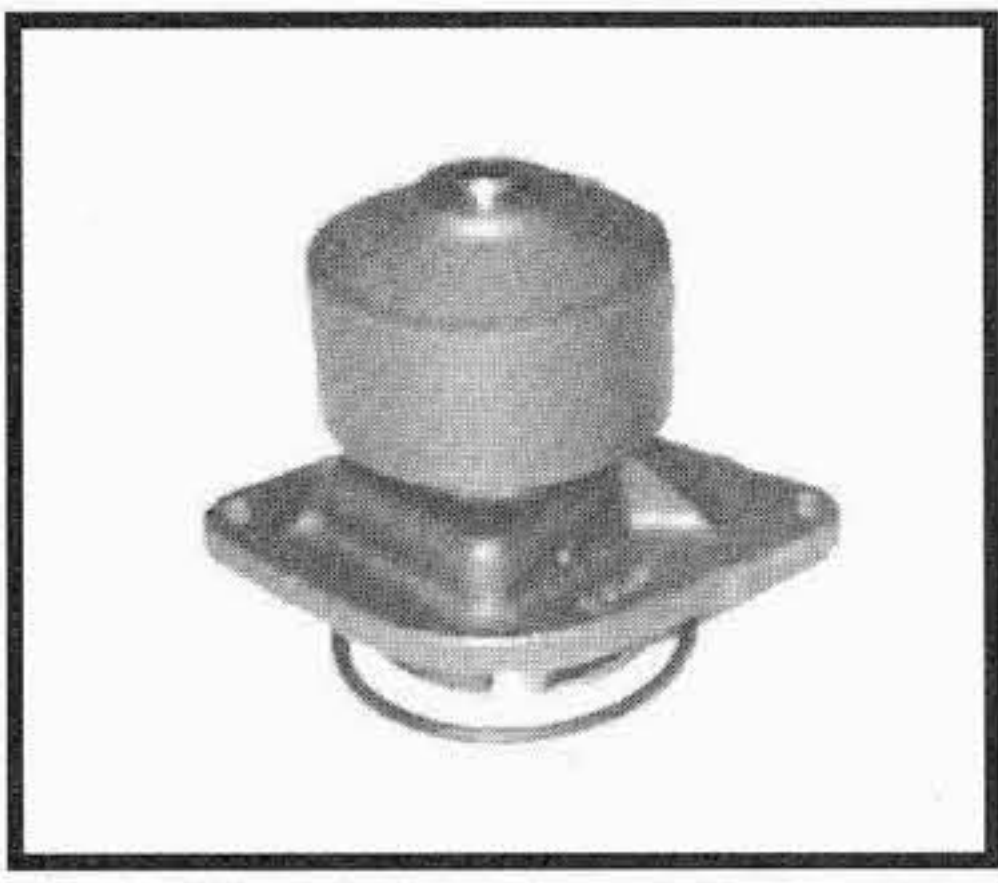
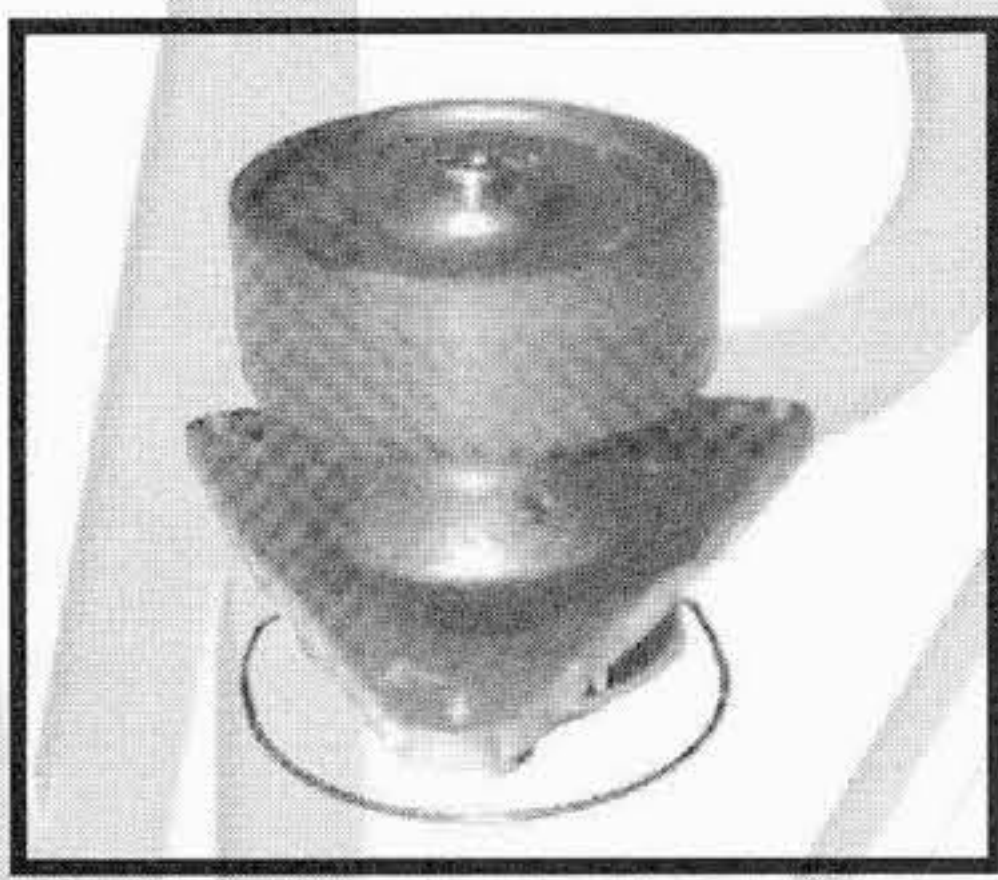
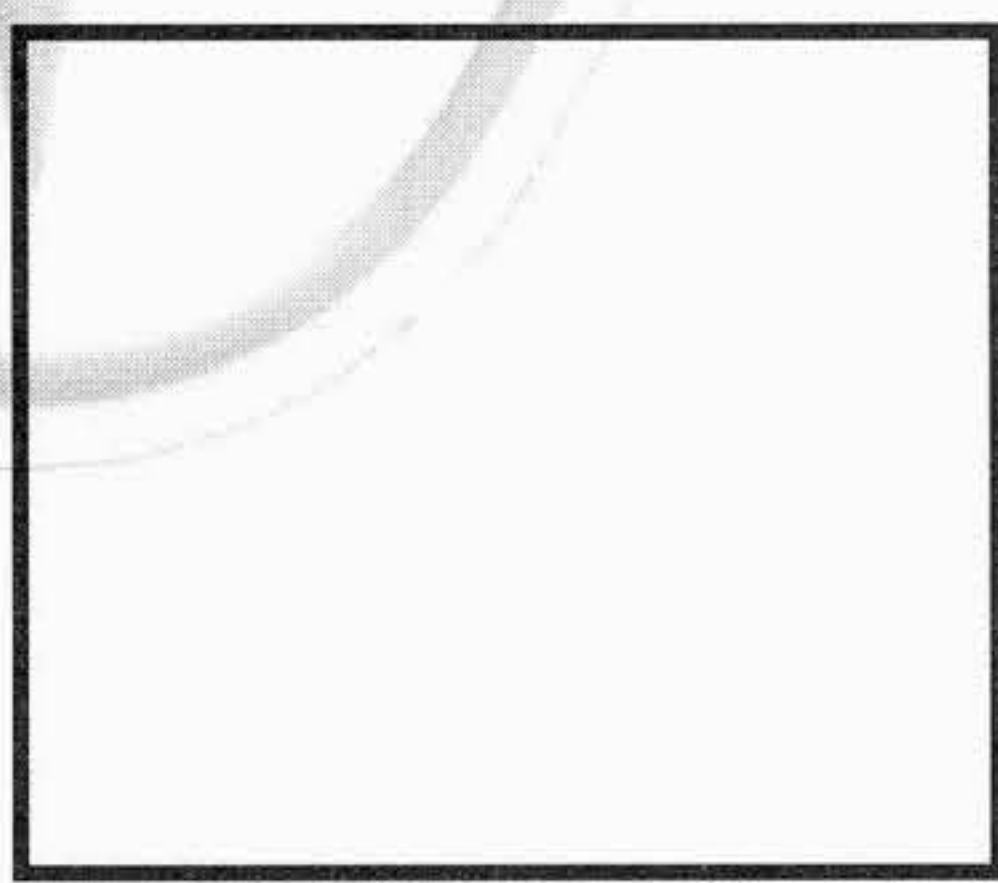
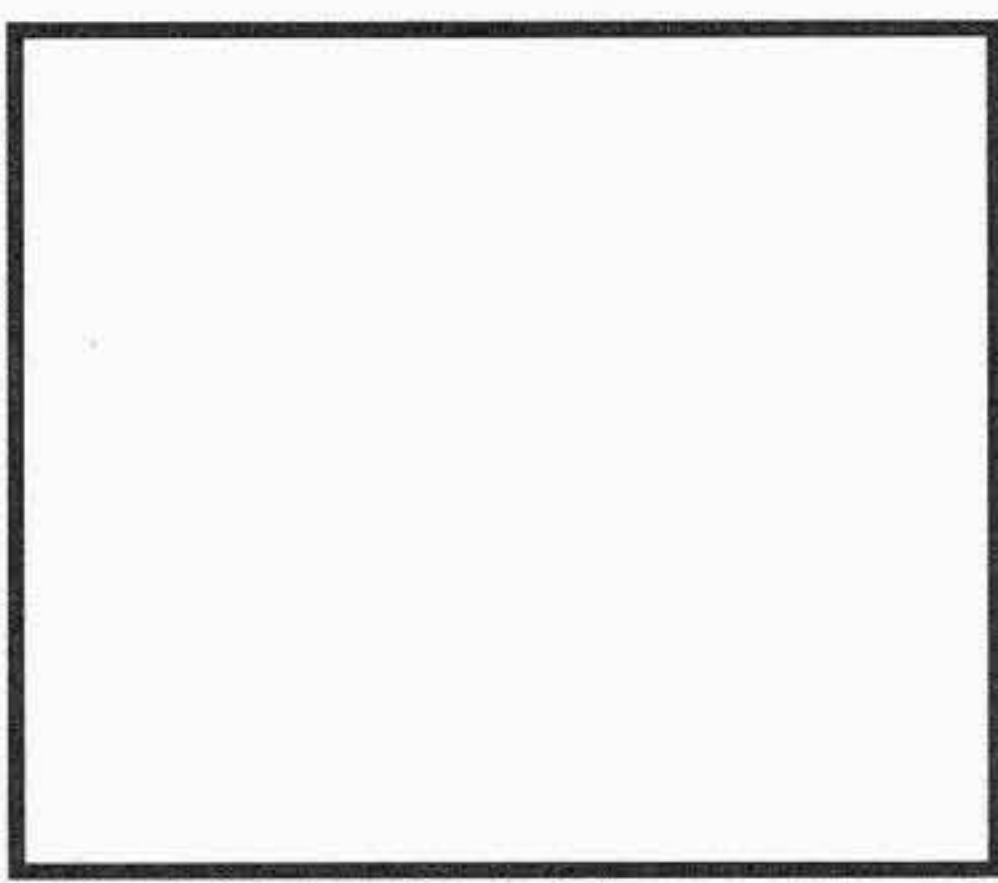
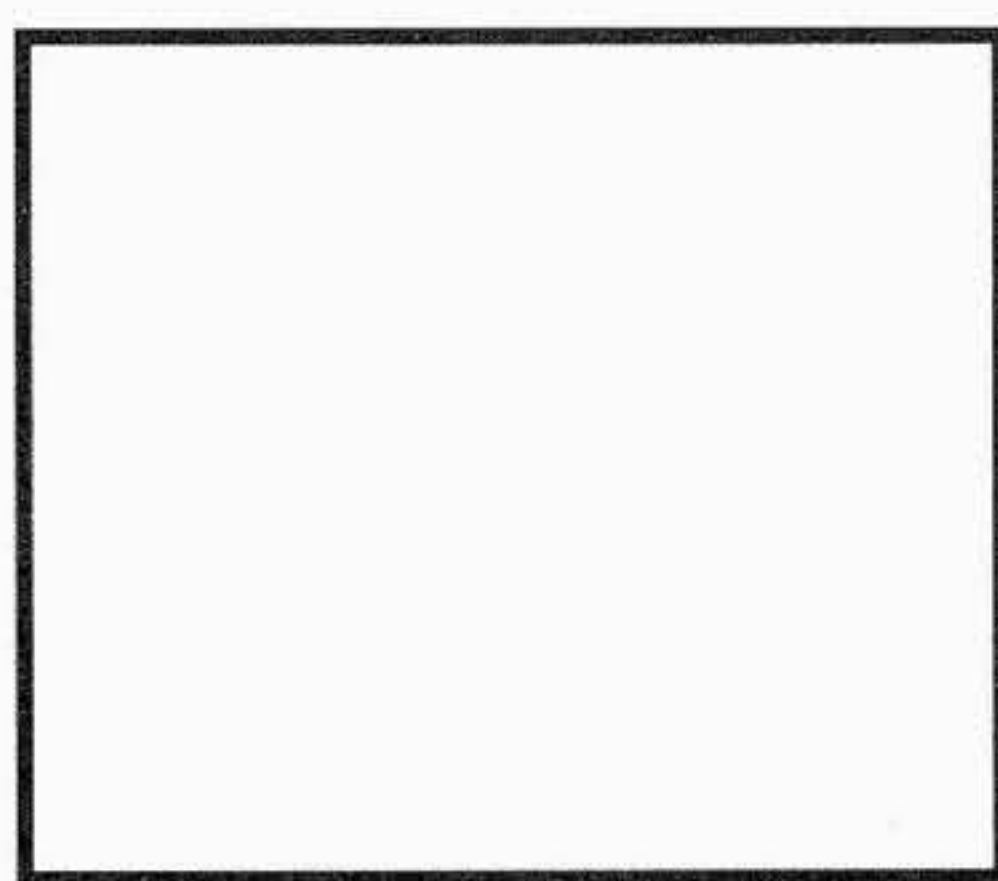
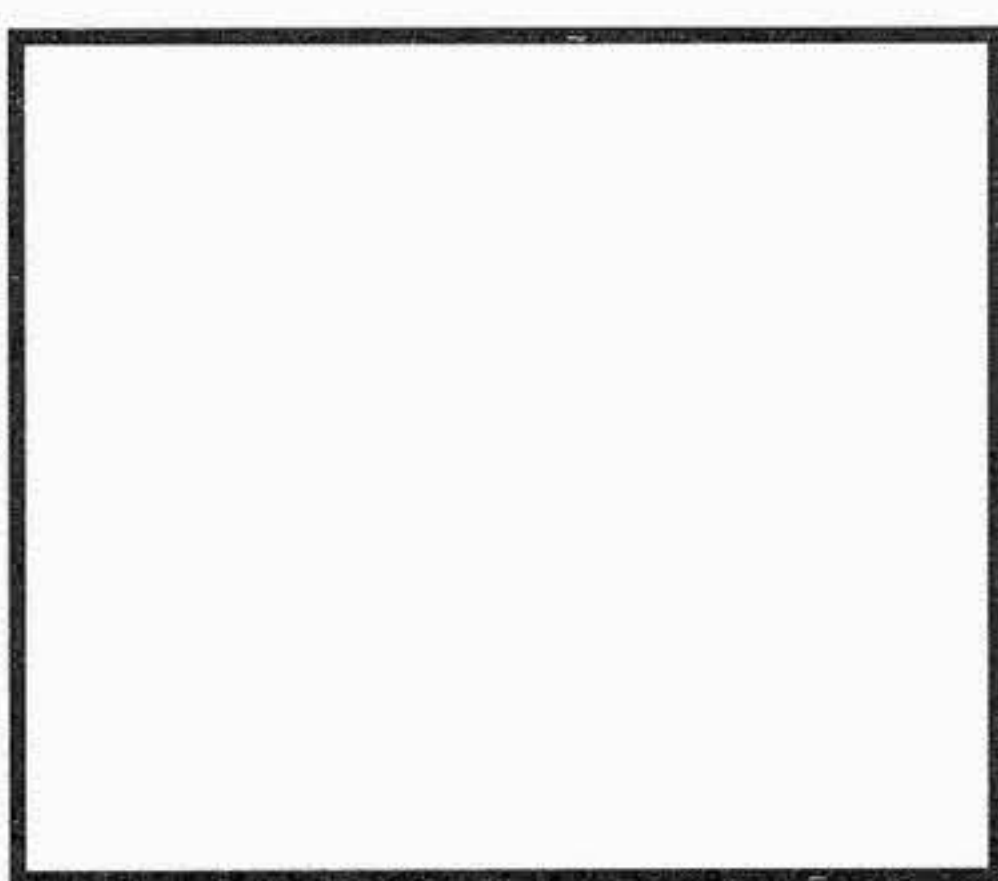

TIPO O MODELLO TYPE OU MODELE TYPE OR MODEL	MOTORE MOTEUR ENGINE	POMPA ACQUA POMPE A EAU WATER PUMP	KIT RIPARAZIONE NECESSAIRE DE REP. REPAIR KIT
<p><b>EXCAVATOR</b></p> <p>3.14</p> <p>3.22</p> <p>3.26 *</p> <p>3.130 W</p> <p>3.150 W</p>	<p>4BT</p> <p>6BT</p> <p>6BTA</p> <p>4BT</p> <p>6BT</p>	<p><b>221.020</b> 76191549</p> 	<p><b>NON DISPONIBILE</b> <b>NOT AVAILABLE</b></p>
<p><b>EXCAVATOR</b></p> <p>FH 270</p> <p><b>GRADER</b></p> <p>FG 70 B</p> <p>FG 75 B</p> <p>FG 85 B</p> <p>FG 105 B</p>	<p>6CT8.3</p> <p>6C8.3</p> <p>6C8.3</p> <p>6CT8.3</p> <p>6CT8.3</p>	<p><b>221.025</b> 76192604</p> 	<p><b>NON DISPONIBILE</b> <b>NOT AVAILABLE</b></p>
			
			

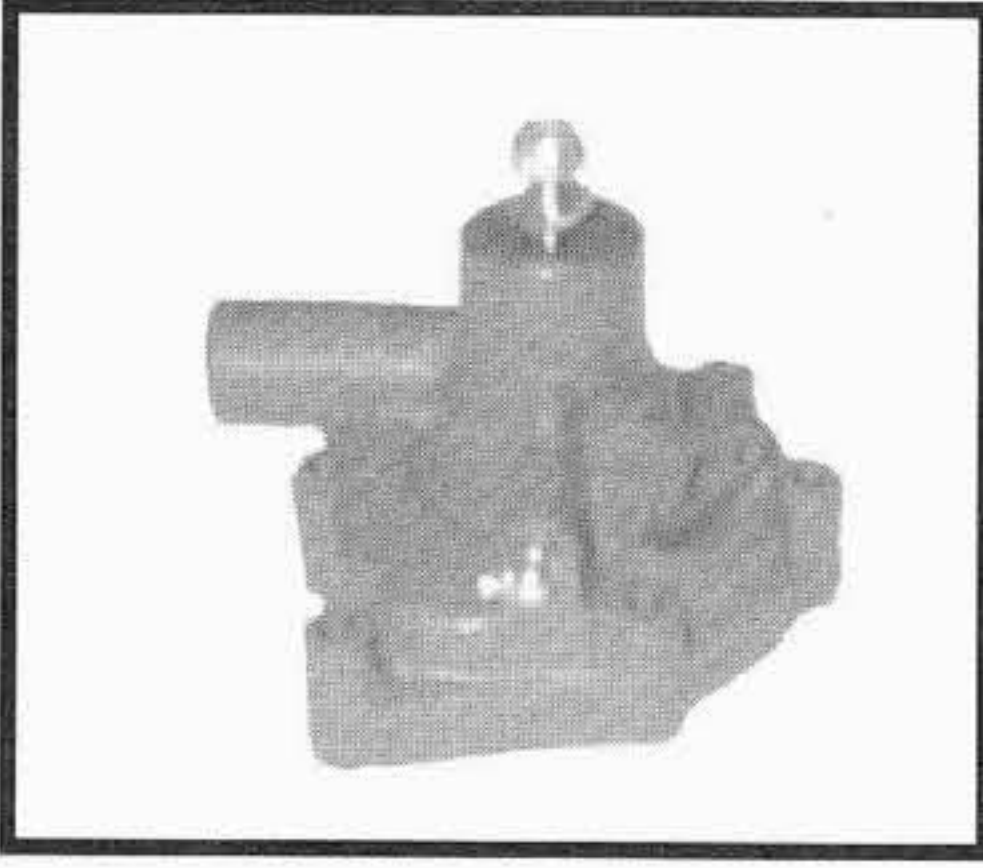
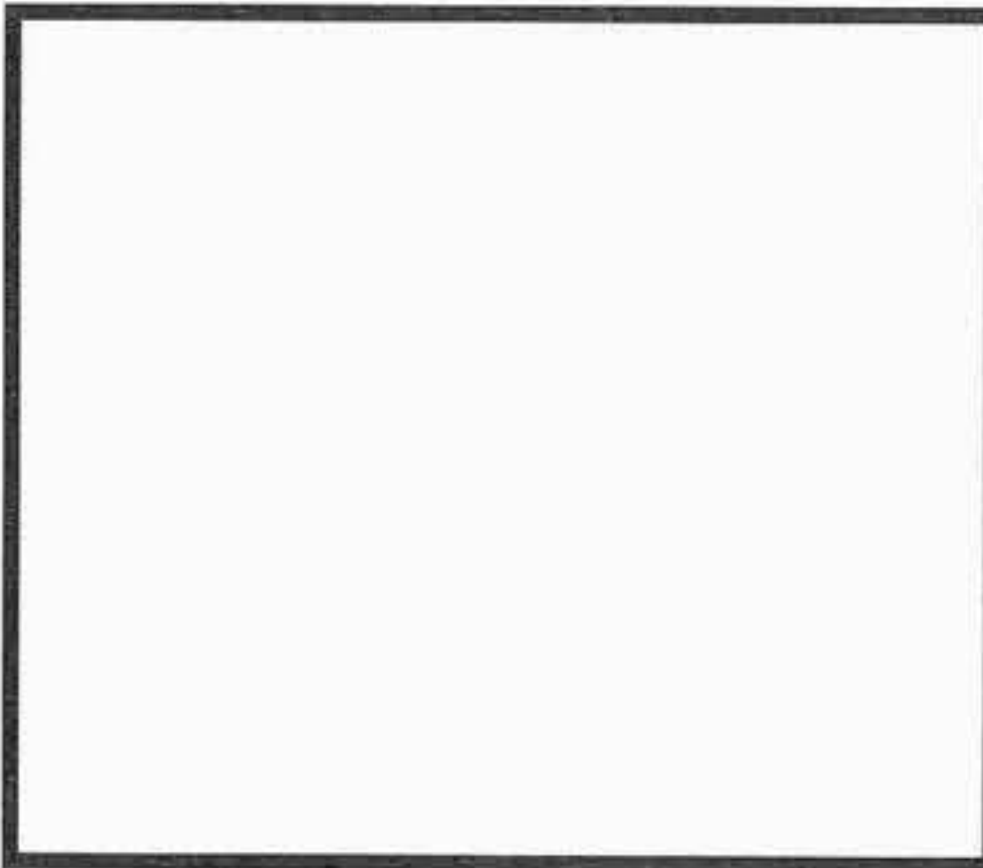
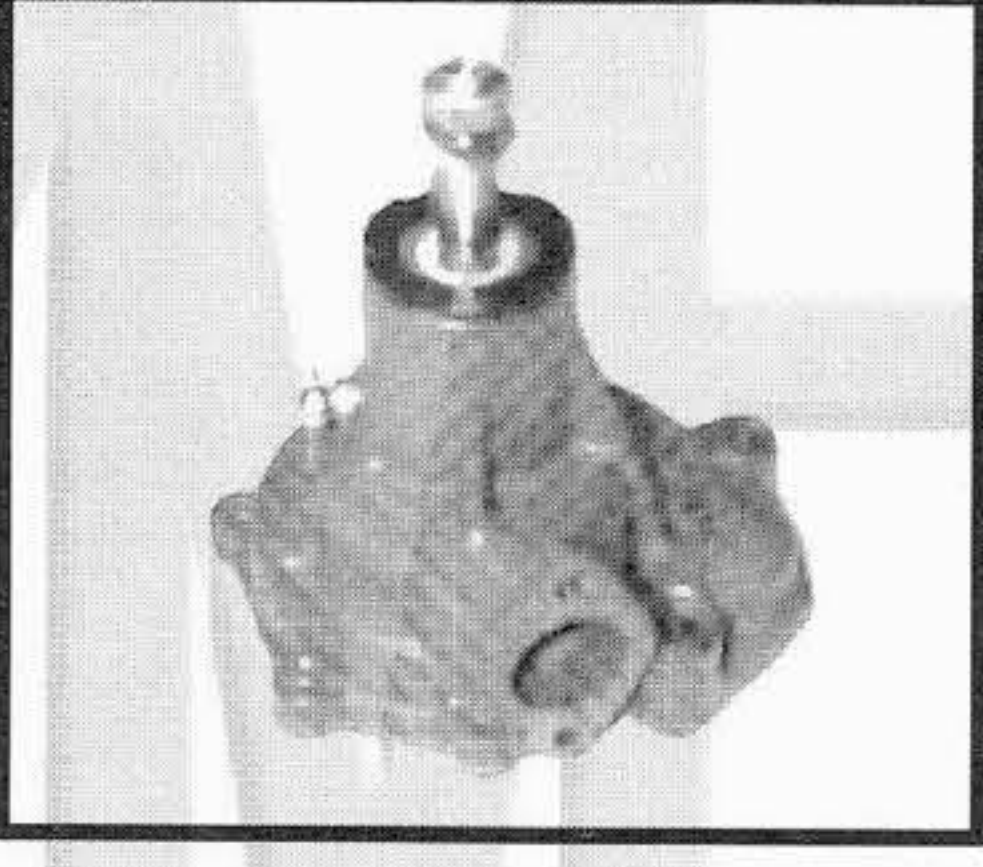
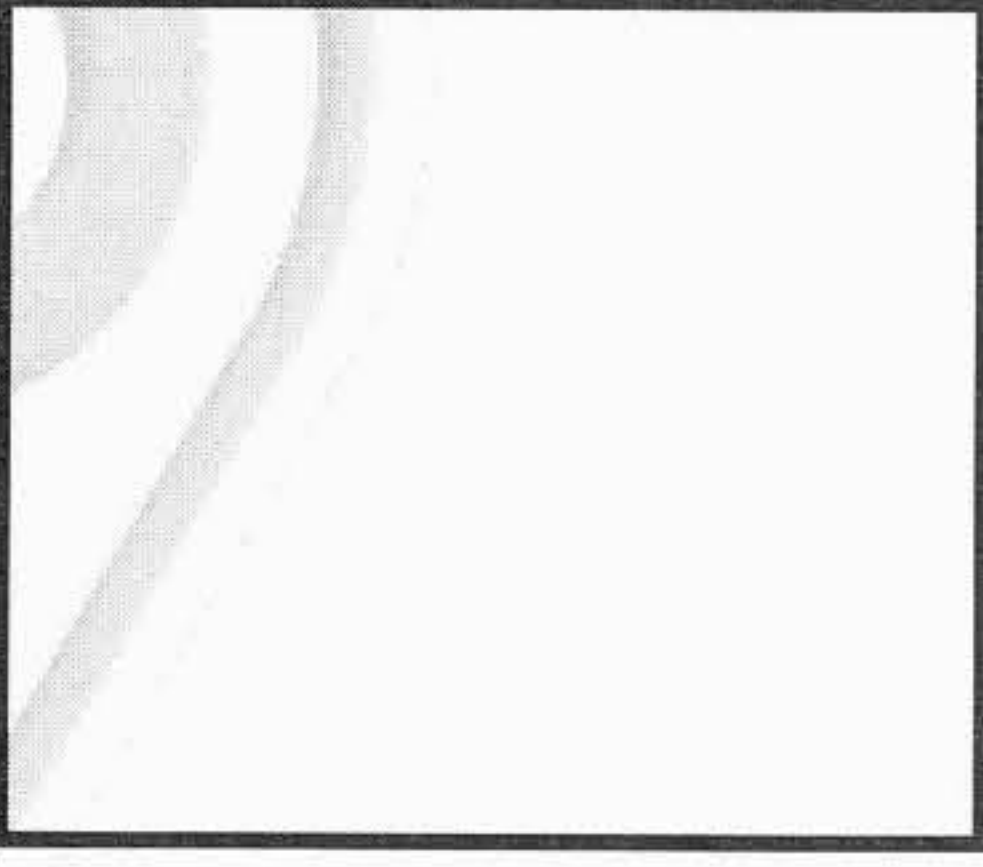
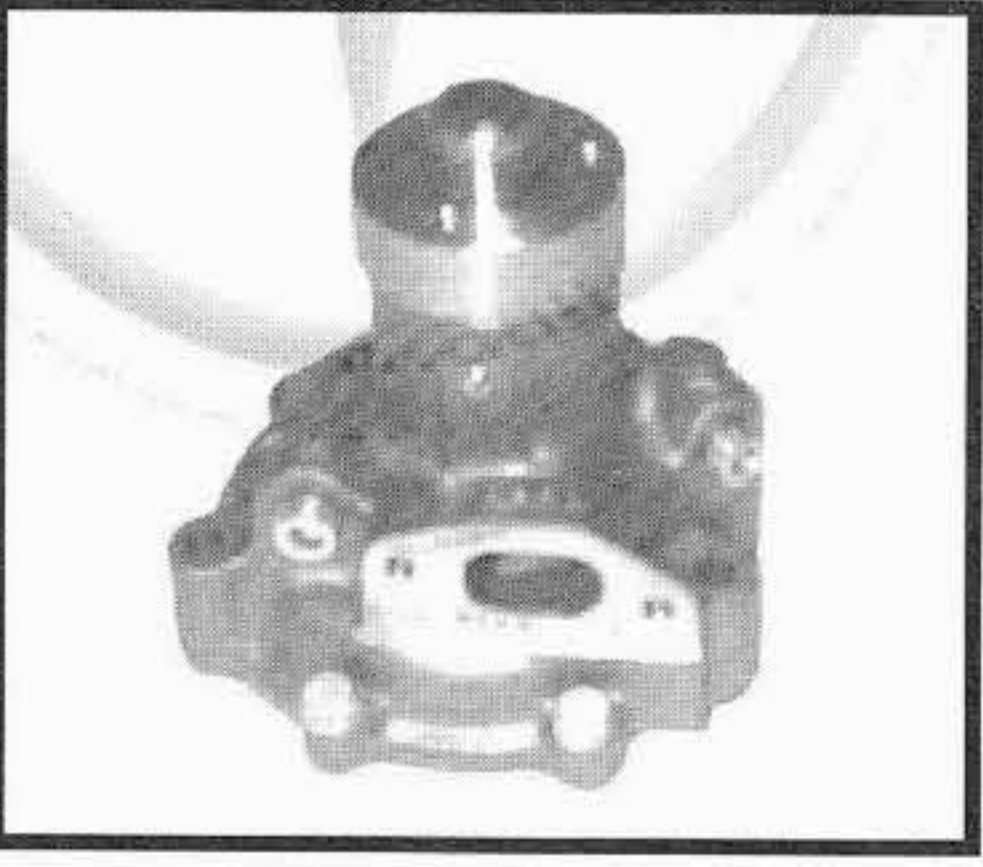
I ricambi non sono originali ma adattabili . Ogni riferimento originale é assolutamente indicativo .  
Spare parts are not original but perfectly suitable . Every original part number has to be considered for reference purpose only .

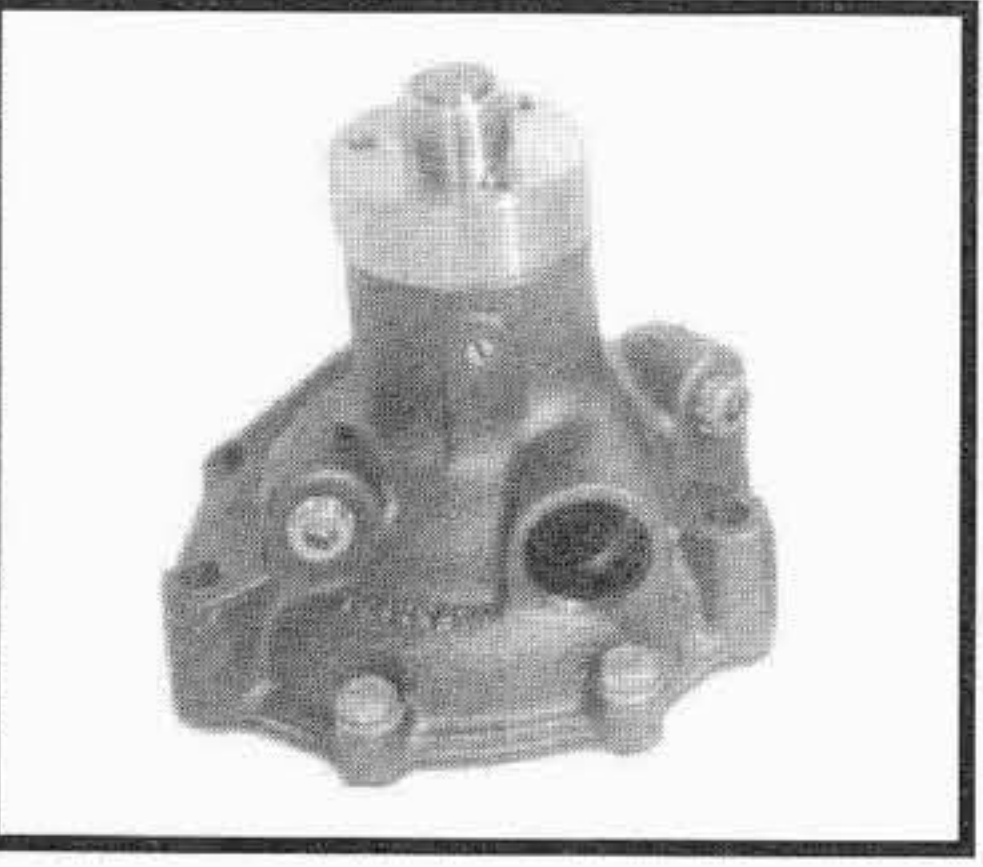
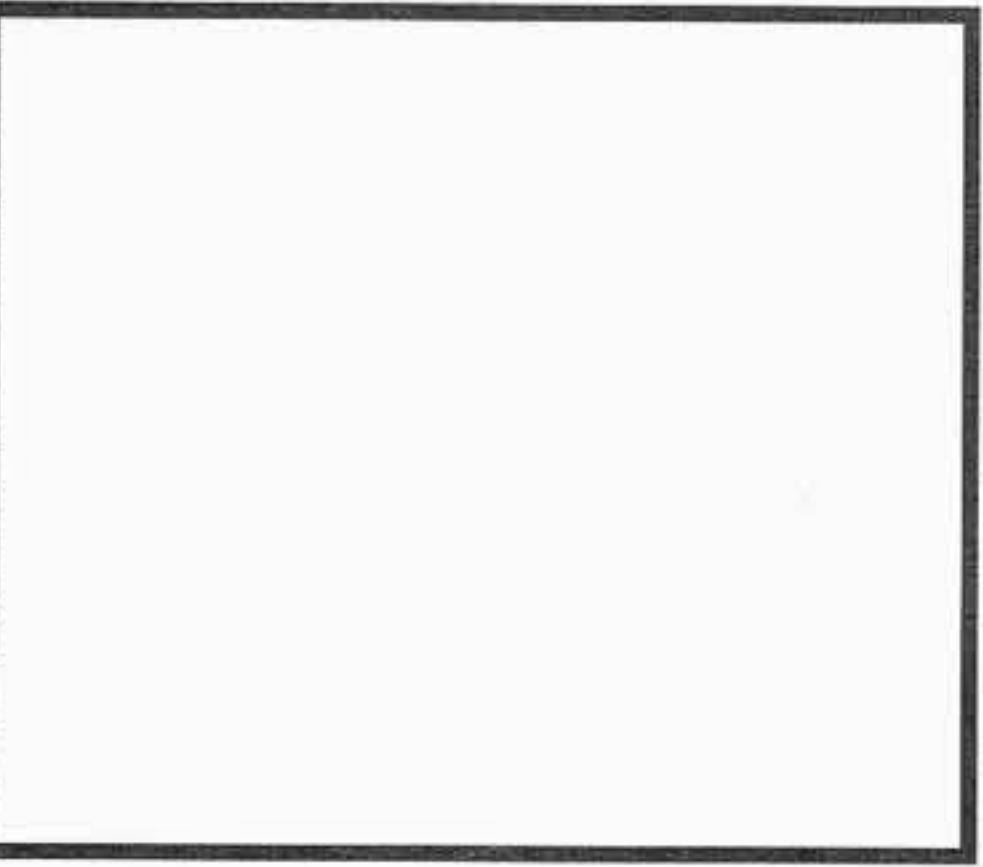
TIPO O MODELLO TYPE OU MODELE TYPE OR MODEL	MOTORE MOTEUR ENGINE	POMPA ACQUA POMPE A EAU WATER PUMP OMP REF. / O.EM. REF	KIT RIPARAZIONE NECESSAIRE DE REP. REPAIR KIT OMP REF. / O.EM. REF
25 C - 25 R	305B	<b>191.155</b> 562988 	<b>192.002</b> --- 
35 - 40 45 - 50 512 - 513 FL6	CO 2	<b>221.450</b> 577837 	<b>202.033</b> 1909625 
45.66 - 45.66DT - 50.66 - 50.66DT 55.46 - 55.46DT - 55.65F - 55.65V 55.65M - 55.66 - 55.66DT - 55.66LP 55.66 LP DT 5 55.66V - 55.66VDT 55.66F - 55.90 - 55.90DT - 60.46 60.46DT - 60.65 - 60.65M - 60.65V 60.66 - 60.66DT - 60.66LP - 60.66F 60.66LP DT60.90 - 60.90DT 65.46 - 65.46DT - 65.66 - 65.66DT 65.90 - 65.90DT - 70.65 - 70.66 70.66DT - 70.66LP - 70.66F 70.66LP DT - 70.90 - 70.90DT 80.65 - 80.66 - 80.66DT - 80.66F 80.66FDT - 80.90 - 80.90DT - 85.55 90.90 - 90.90DT - 95.55C 100.90 - 100.90DT 115.90 - 115.90DT 140.90 - 140.90DT	8035.06.206/306 8035.06.208/308 8035.06.222/322 8035.06.200/300 8045.06.220/320 8045.06.225/325 8045.06.206/306 8045.06.200/300 8045.05.206/306 8045.05.200/300 8055.05.200/205 8065.06.200/300 8065.05.000 8065.25.000	<b>206.265</b> 4813370 	<b>222.264</b> 1940105 
45.66 - 50.66 - 55.46 - 55.65 - 55.66 55.90 - 60.46 - 60.65 - 60.66 - 60.90 65.46 - 65.66 - 65.90 - 70.65 - 70.66 70.90 - 80.65 - 80.66 - 80.90 - 85.55 90.90 - 95.55C - 100.90 - 115.90 140.90DT  <b>SERIE 76 - 86 - 93 - 94</b>  tutti i modelli / all models 01 / 93 ---> 12 / 95	8035.05 - 8035.06 8045.05 - 8045.06 8055.05 - 8055.06 8065.05 - 8065.06 8065.25.000	<b>226.334</b> 98497117 	<b>222.264</b> 1940105 

I ricambi non sono originali ma adattabili . Ogni riferimento originale é assolutamente indicativo .  
 Spare parts are not original but perfectly suitable . Every original part number has to be considered for reference purpose only .







SUITABLE

# NEW HOLLAND FIAT TRATTORI

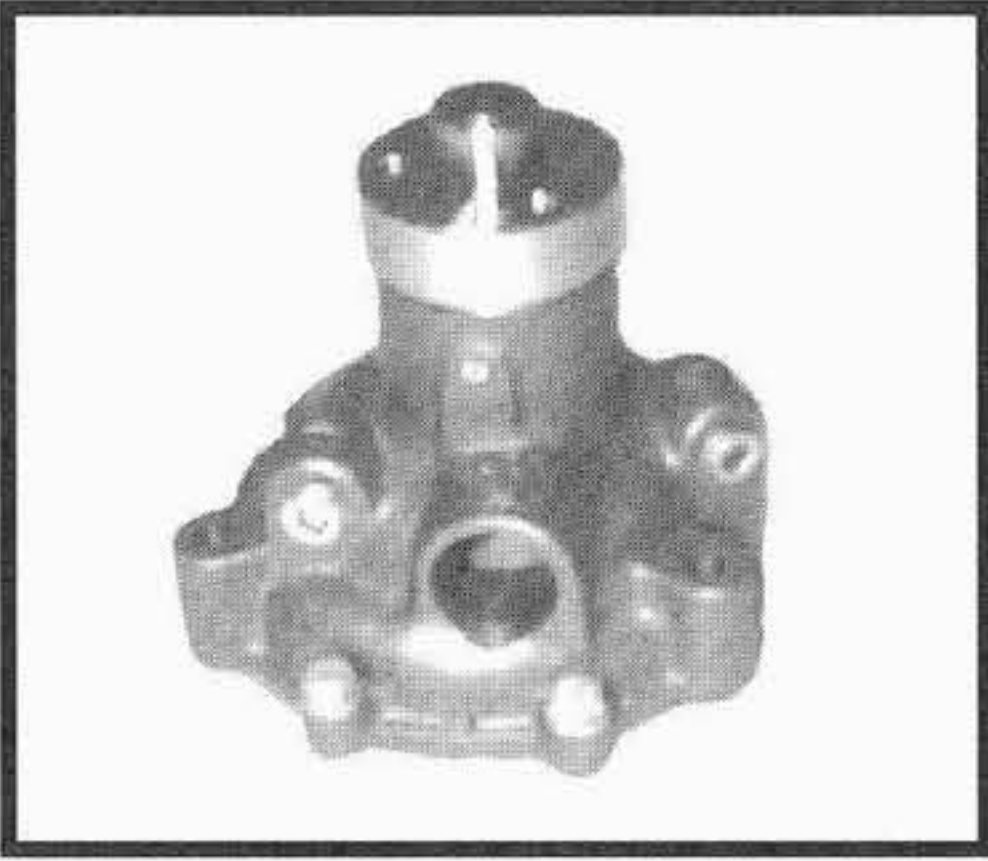
Tel: +44(0)1925 850082 Fax: +(0)44 1925 850083

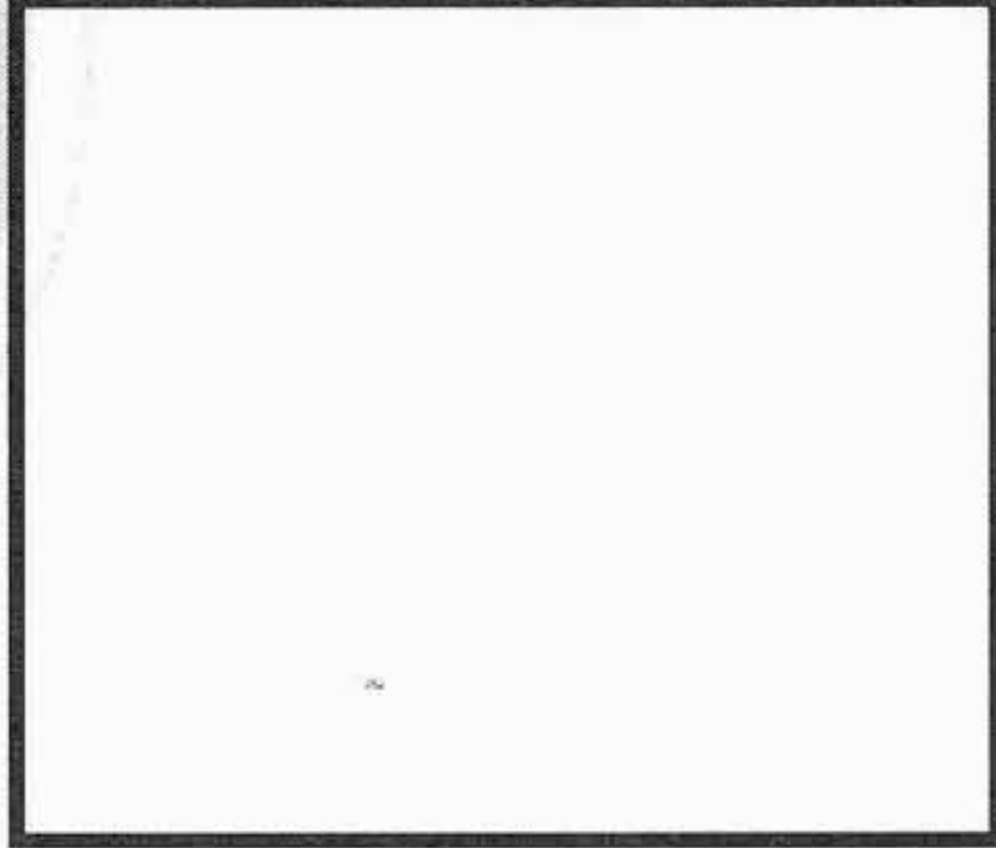
www.spwaterpumps.co.uk

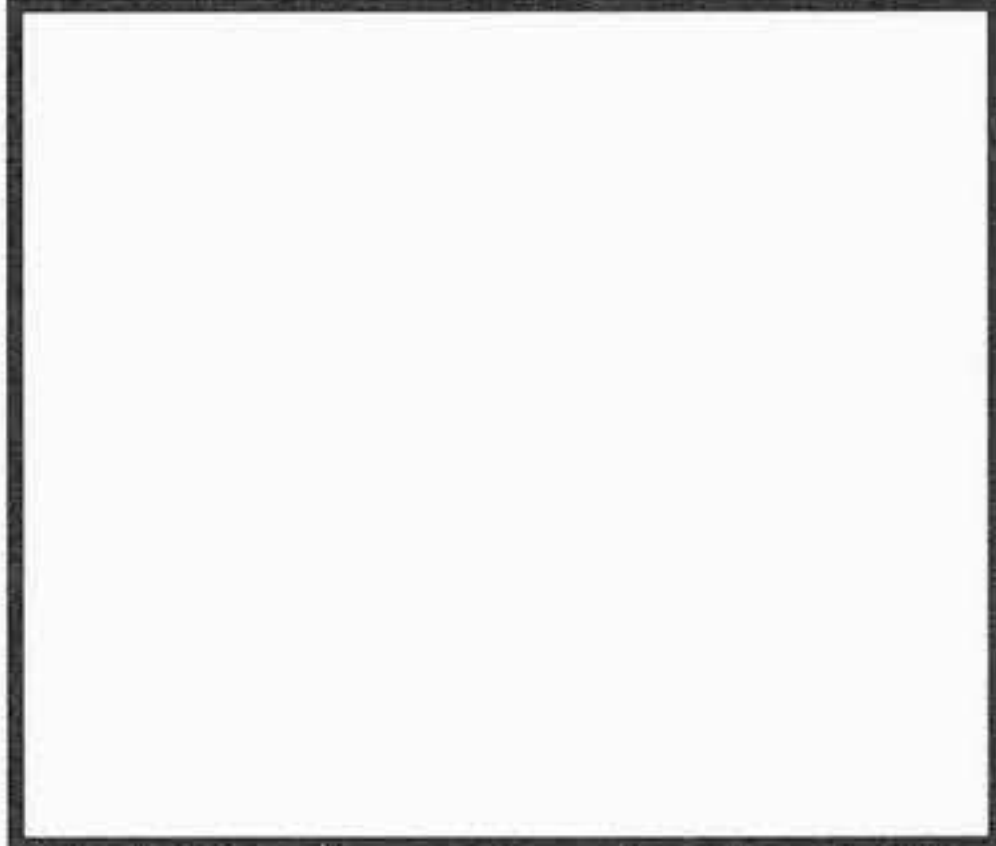

TIPO O MODELLO TYPE OU MODELE TYPE OR MODEL	MOTORE MOTEUR ENGINE	POMPA ACQUA POMPE A EAU WATER PUMP OMP REF. / O.EM. REF	KIT RIPARAZIONE NECESSAIRE DE REP. REPAIR KIT OMP REF. / O.EM. REF
45.66 - 50.66 - 55.46 - 55.65 - 55.66 55.90 - 60.46 - 60.65 - 60.66 - 60.90 65.46 - 65.66 - 65.90 - 70.65 - 70.66 70.90 - 80.65 - 80.66 - 80.90 - 85.55 90.90 - 95.55C - 100.90 - 115.90 140.90DT  SERIE 76 - 86 - 93 - 94  SERIE TNF TN65F - TN75F - TN90F  tutti i modelli / all models 01 / 96 --->	8035.05 - 8035.06 8045.05 - 8045.06 8055.05 - 8055.06 8065.05 - 8065.06 8065.25.000	<p style="text-align: center;"><b>226.441</b> 99454833</p> 	<p style="text-align: center;"><b>222.281</b> 1940144</p> 
55 - 60 - 70	604	<p style="text-align: center;"><b>201.587</b> 552387 CON PULEGGIA / WITH PULLEY</p>  <p style="text-align: center;"><b>201.585</b> --- SENZA PULEGGIA / WITHOUT PULLEY</p>	<p style="text-align: center;"><b>202.051</b> ---</p> 
70 C versione 200 / 201	604.030 ---> fino al mot. 084045	<p style="text-align: center;"><b>201.588</b> 580210 CON PULEGGIA / WITH PULLEY</p>  <p style="text-align: center;"><b>201.585</b> --- SENZA PULEGGIA / WITHOUT PULLEY</p>	<p style="text-align: center;"><b>202.051</b> ---</p> 
70 C versione 204 / 205 / 208 / 209	604.030 ---> fino al mot. 084045	<p style="text-align: center;"><b>201.590</b> 586017 CON PULEGGIA / WITH PULLEY</p>  <p style="text-align: center;"><b>201.585</b> --- SENZA PULEGGIA / WITHOUT PULLEY</p>	<p style="text-align: center;"><b>202.051</b> ---</p> 

I ricambi non sono originali ma adattabili . Ogni riferimento originale é assolutamente indicativo .  
 Spare parts are not original but perfectly suitable . Every original part number has to be considered for reference purpose only .



SUITABLE

# NEW HOLLAND FIAT TRATTORI

Tel: +44(0)1925 850082 Fax: +(0)44 1925 850083

www.spwaterpumps.co.uk

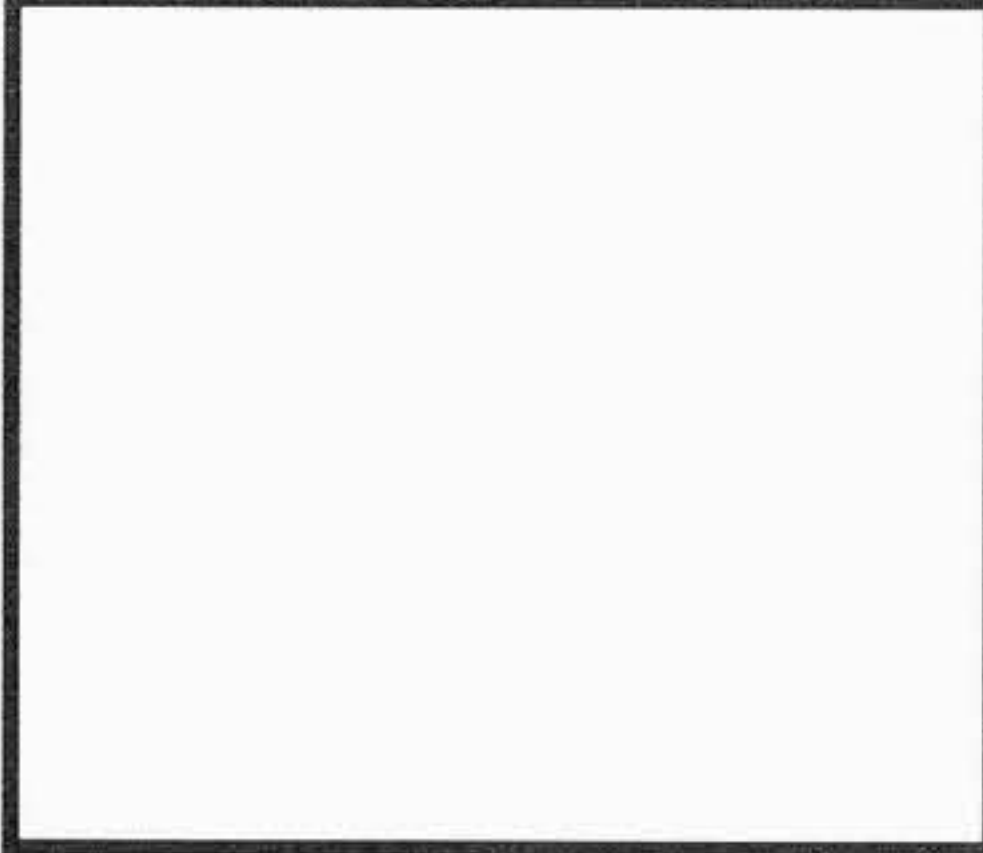
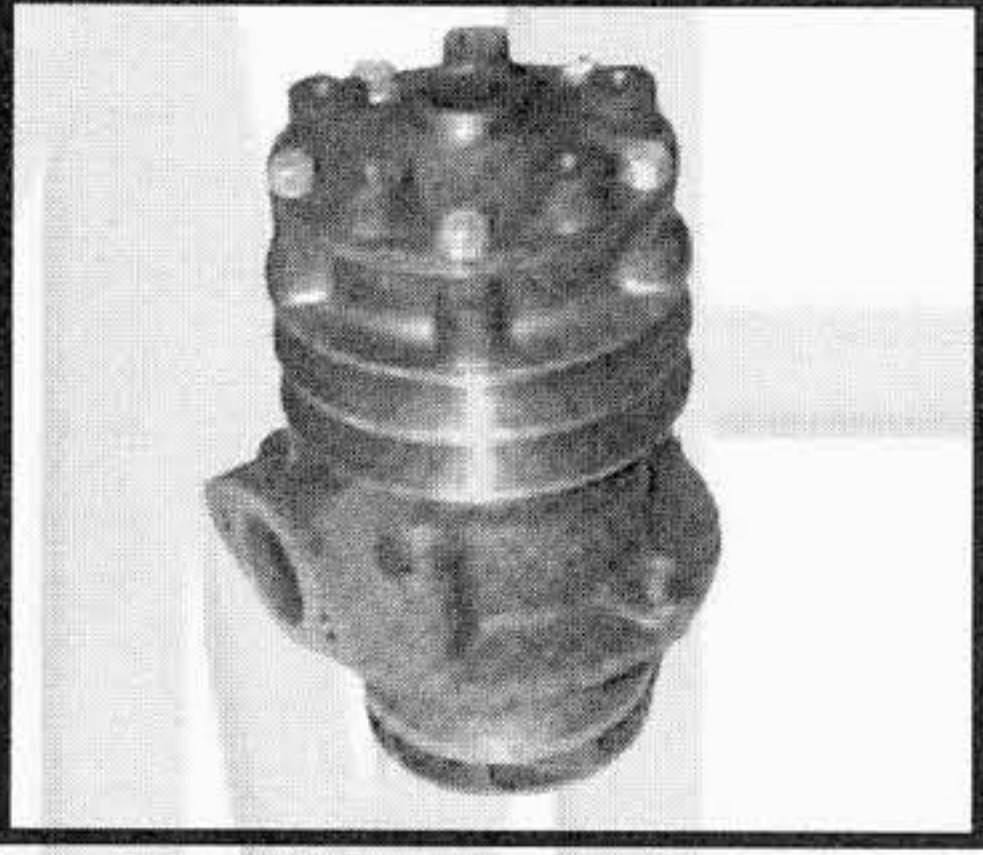

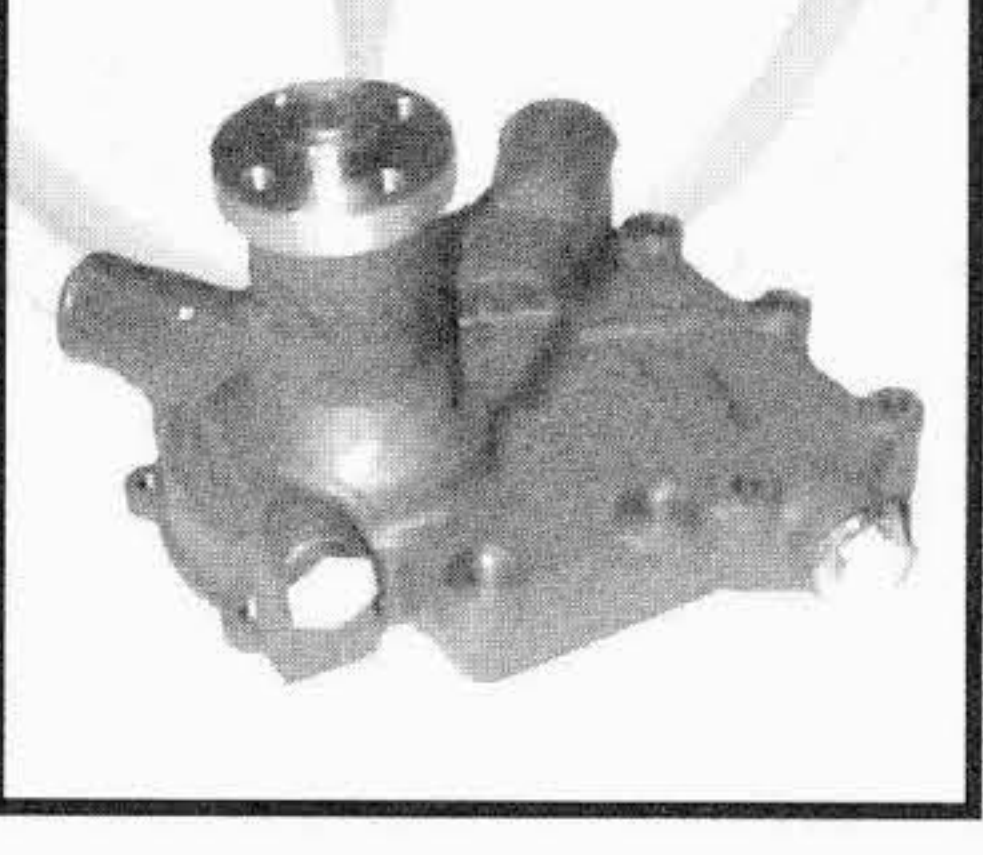
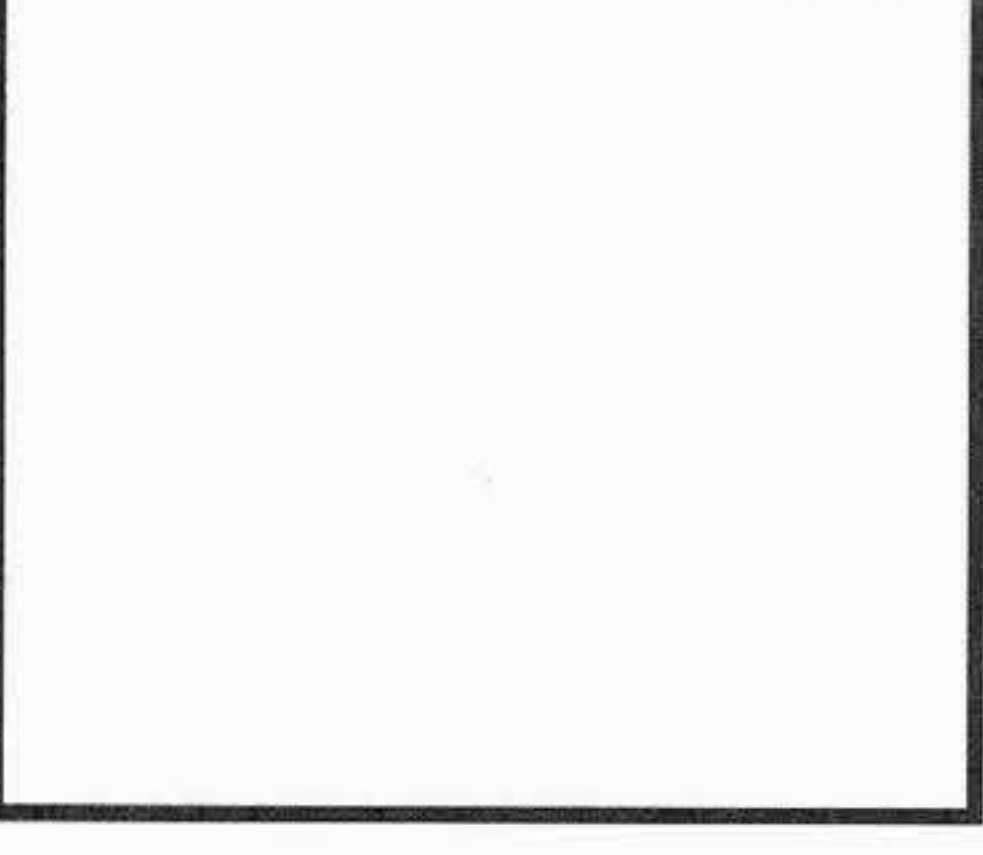
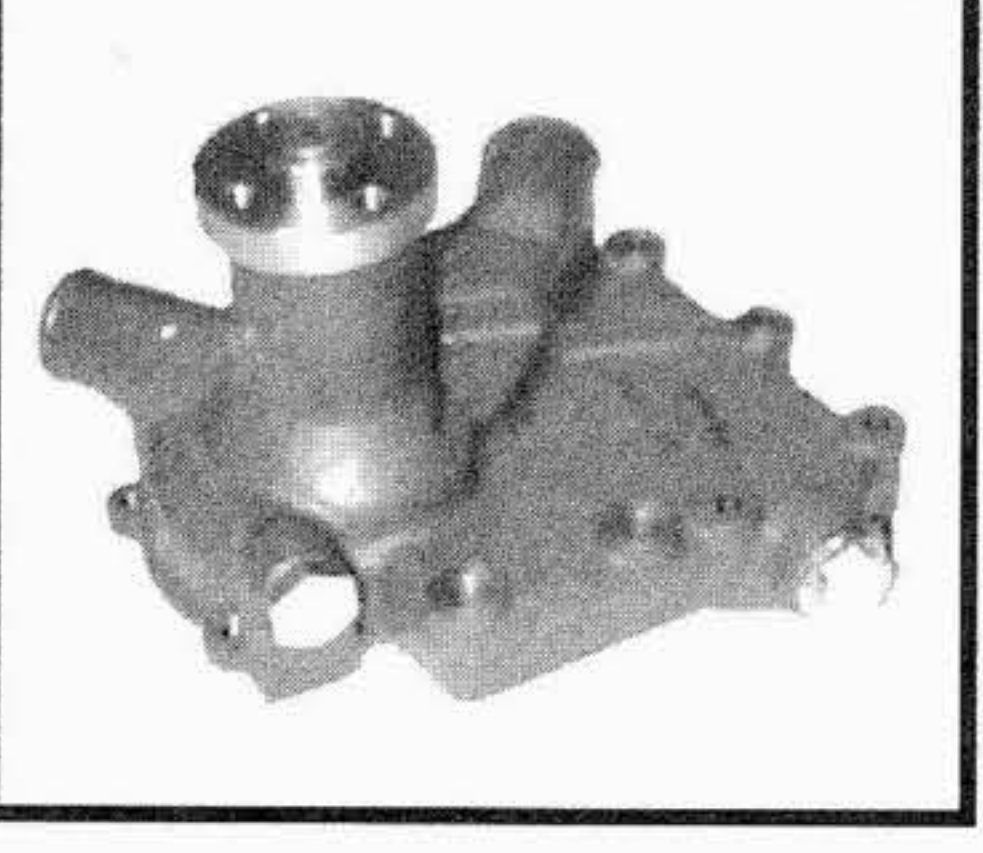
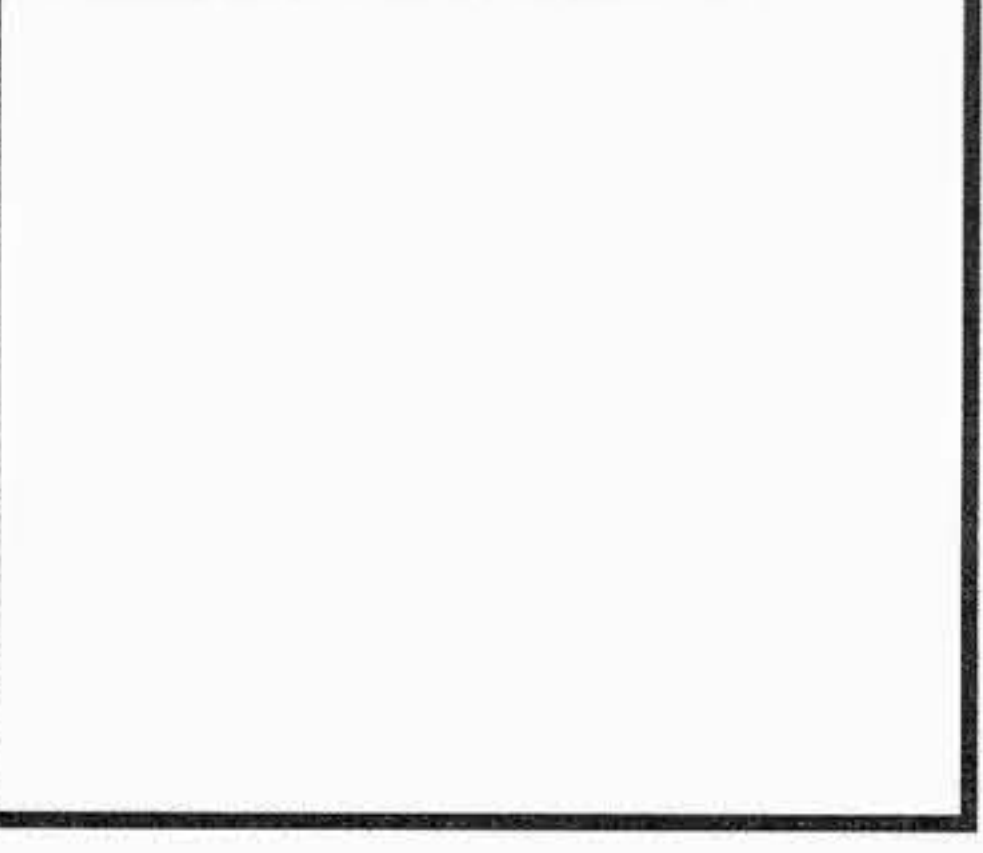



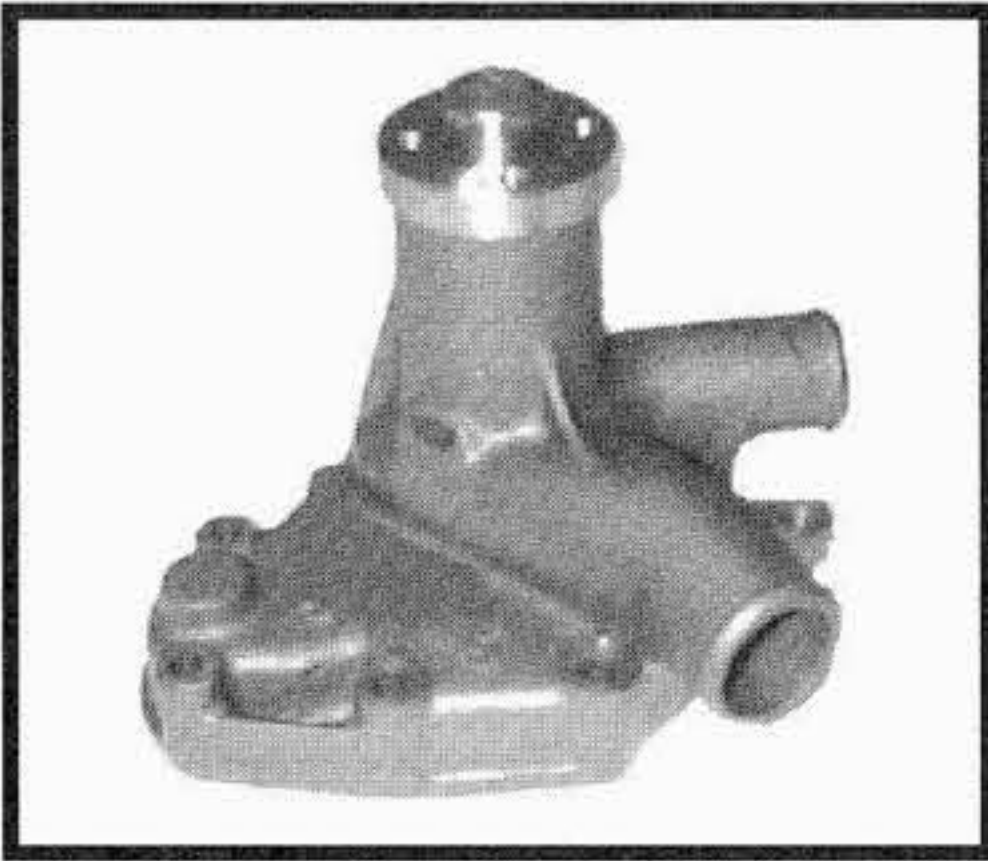
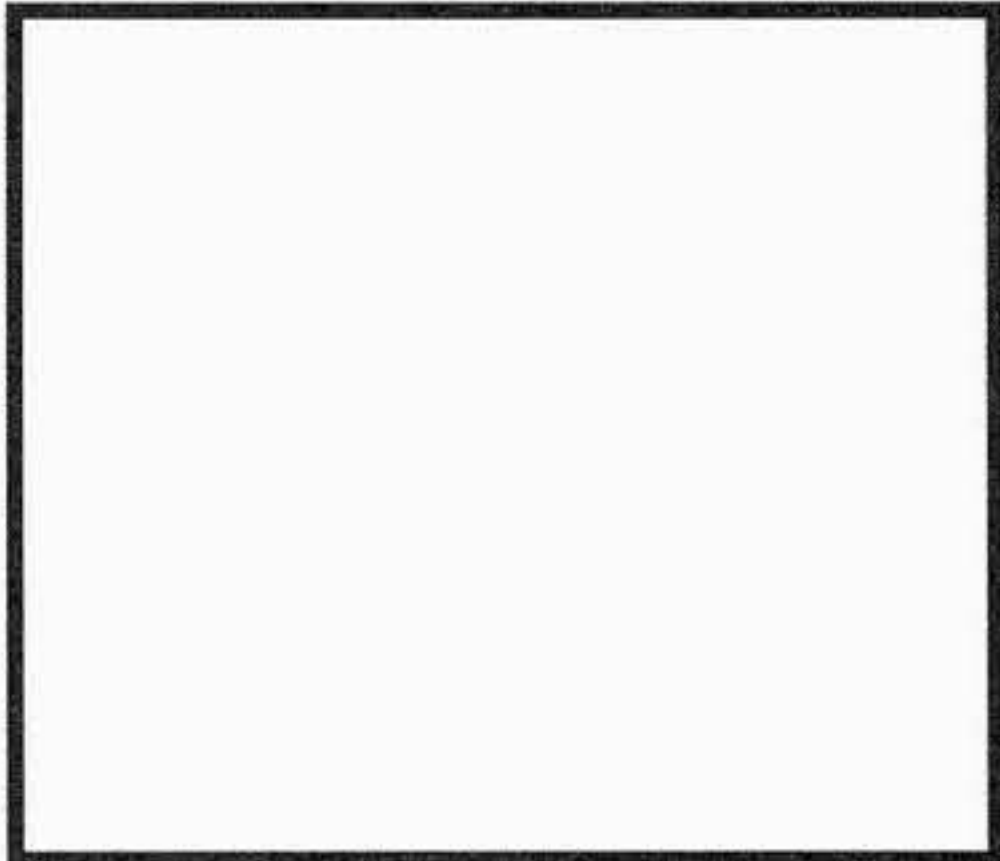

TIPO O MODELLO TYPE OU MODELE TYPE OR MODEL	MOTORE MOTEUR ENGINE	POMPA ACQUA POMPE A EAU WATER PUMP OMP REF. / O.EM. REF	KIT RIPARAZIONE NECESSAIRE DE REP. REPAIR KIT OMP REF. / O.EM. REF
70 C versione 200 / 201	604.030 dal mot. 084046 --->	<p><b>201.596</b> 4629940 CON PULEGGIA / WITH PULLEY</p>  <p><b>201.595</b> --- SENZA PULEGGIA / WITHOUT PULLEY</p>	<p><b>202.056</b> 1909615</p> 
70 C versione 204 / 205 / 208 / 209	604.030 dal mot. 084046 --->	<p><b>201.597</b> 4959164 CON PULEGGIA / WITH PULLEY</p>  <p><b>201.595</b> --- SENZA PULEGGIA / WITHOUT PULLEY</p>	<p><b>202.056</b> 1909615</p> 
80 C 100 C 120 C	CP3 / 100 CP3 / 100 var. 20 CP3 / 100 var.21/22	<p><b>201.955</b> 4757341</p> 	<p><b>222.267</b> 76032963</p> 
90 C	CO3.130T var.2.300	<p><b>201.935</b> 4757340</p> 	<p><b>202.016</b> 1909829</p> 

I ricambi non sono originali ma adattabili . Ogni riferimento originale é assolutamente indicativo .  
Spare parts are not original but perfectly suitable . Every original part number has to be considered for reference purpose only .

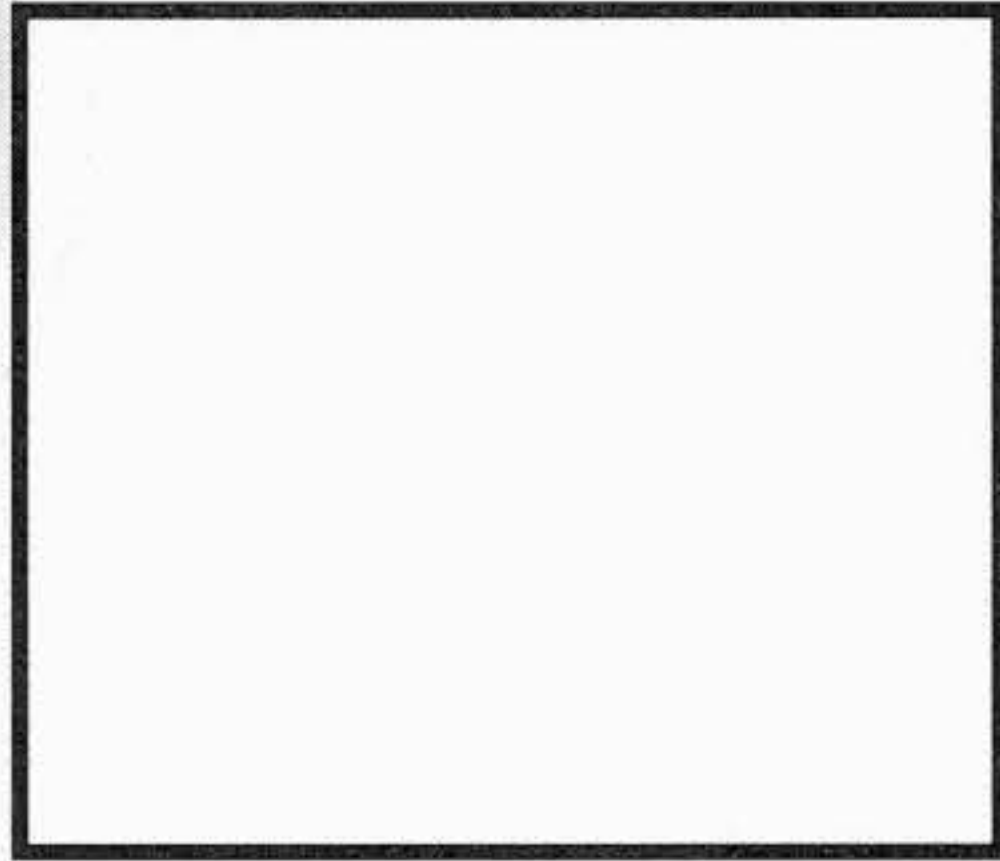
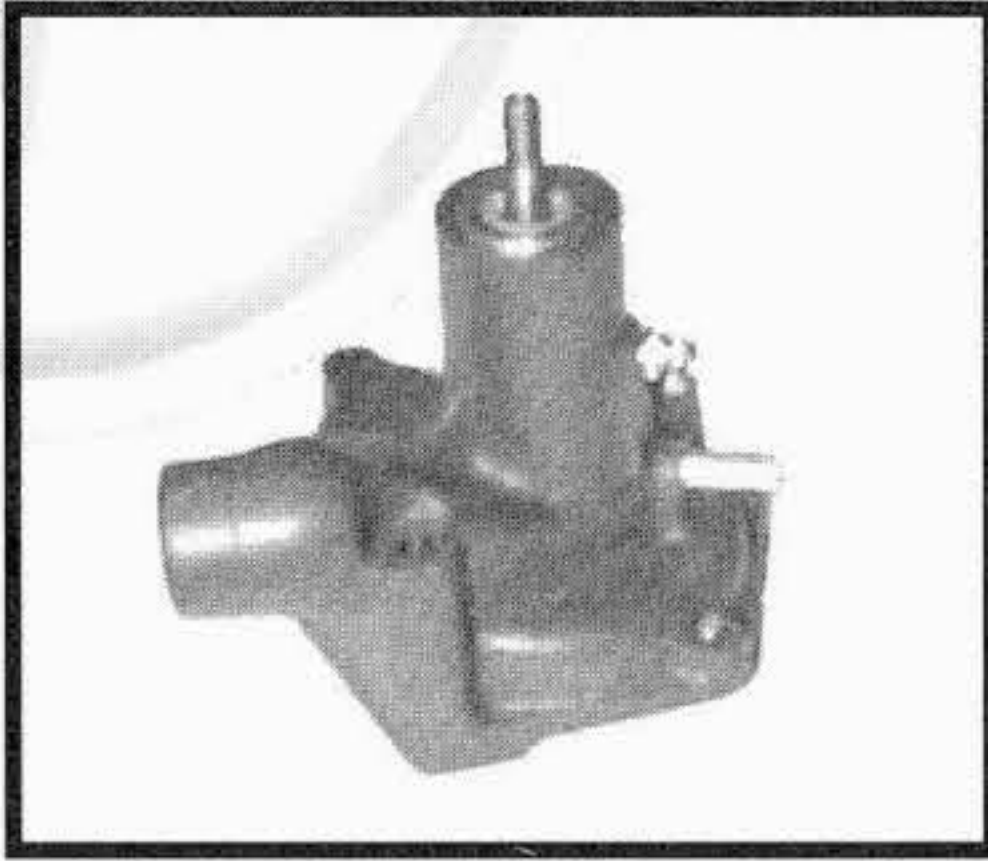
SUITABLE

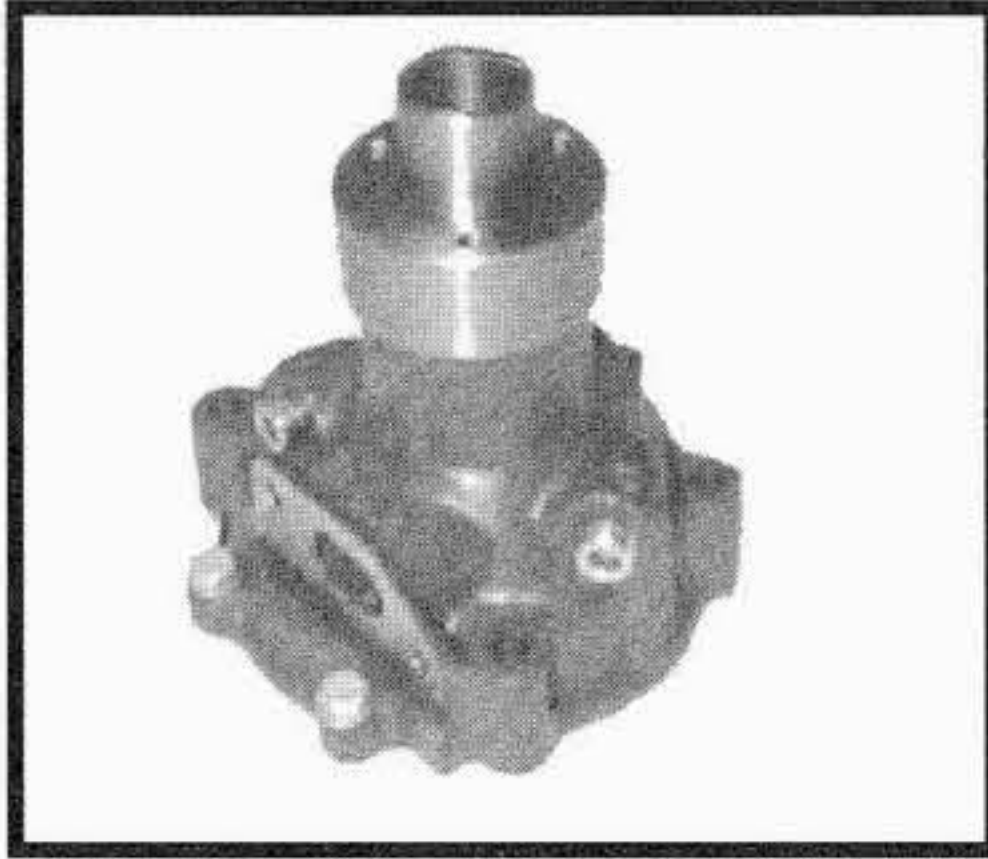
**NEW HOLLAND****FIAT TRATTORI****Tel:+44(0)1925 850082 Fax: +(0)44 1925 850083****www.spwaterpumps.co.uk**

TIPO O MODELLO TYPE OU MODELE TYPE OR MODEL	MOTORE MOTEUR ENGINE	POMPA ACQUA POMPE A EAU WATER PUMP	OMP REF. / O.EM. REF	KIT RIPARAZIONE NECESSAIRE DE REP. REPAIR KIT	OMP REF. / O.EM. REF
160.90 - 160.90 DT 180.90 - 180.90 DT 1355 C 1580 - 1580 DT 1580 DT turbo 1880 - 1880 DT	8365.25.503 8365.25.502 8365.05.590 8365.05.500 8365.25.501 8365.25.500	<b>206.100</b> 	4796534	<b>202.268</b> 	1940119
250 / N / F / DT - 300 / N / F / DT 350 / N / S / DT - 355 / M / F / C 400 / N / DT / DTN - 420 / DT - 440 / DT / V 446 / DT - 450 / F / V / DT / S R450 / N / V / DT - 455 / M / V / CI / C / CM / M / CF 455 SUPER - 460 / DT - 465 C / CV 465 CF - 466 DT - 470 / DT / E / F / S 470 S DT - 474 / DT - 480 / DT / V / S 480.8 / DT / V - 500 / DT / S / DTS 505 C / CM / V / S - 540 S / VS / DTS 540 / F / FS / DT - 550 / DT / 555 / M 565 C / CL - 566 / DT - 570 / DT / V / DTF 600 / DT - 605 C / CM / CS / CMS 640 / DT - 665 C / CM / 666 / DT 670 / DT / F / FDT - 765 C - 766 / DT 880.5 / DT5 - 980 / DT - 1000 / DT 1000 / S / SDT - 1180 / DT - 1280 / DT 1380 / DT	8025.01 8035.01 8035.02.309 8035.01.305 8035.02.276/376 8035.02.313 8045.01.211 8045.02.271/278.371.378 8065.02 8065.04 8065.24	<b>196.319</b> 	93191101	<b>222.260</b> 	76029352
400 - 411 - 415 - FL4	615.000	<b>201.390</b> 	566997	<b>202.025</b> 	1909619
580 - 580 DT 680 - 680 DT 780 - 780 DT 855C	8035.04.370/377 8045.02. 270/277/370/377 8045.02. 270/277/370/377 8045.04.275/375	<b>196.326</b> 	1930925	<b>222.261</b> 	1940104

I ricambi non sono originali ma adattabili . Ogni riferimento originale é assolutamente indicativo .

Spare parts are not original but perfectly suitable . Every original part number has to be considered for reference purpose only .

SUITABLE

**NEW HOLLAND**

**FIAT TRATTORI**

**Tel:+44(0)1925 850082 Fax: +(0)44 1925 850083**

**www.spwaterpumps.co.uk**

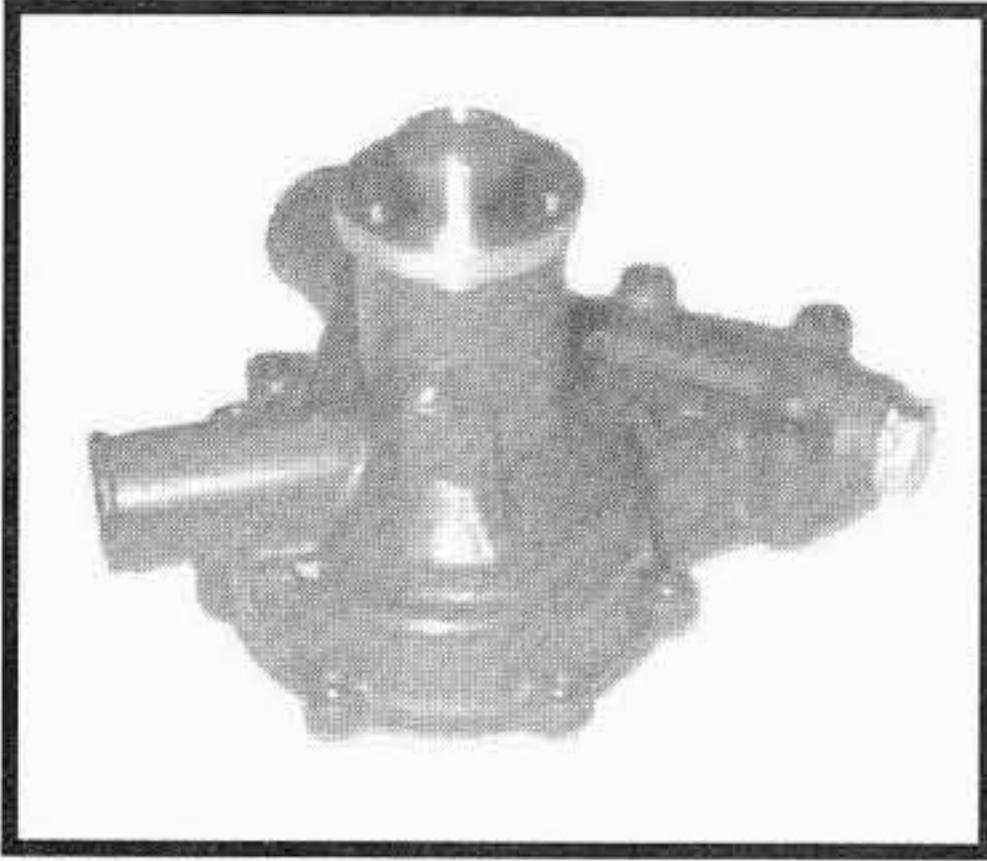
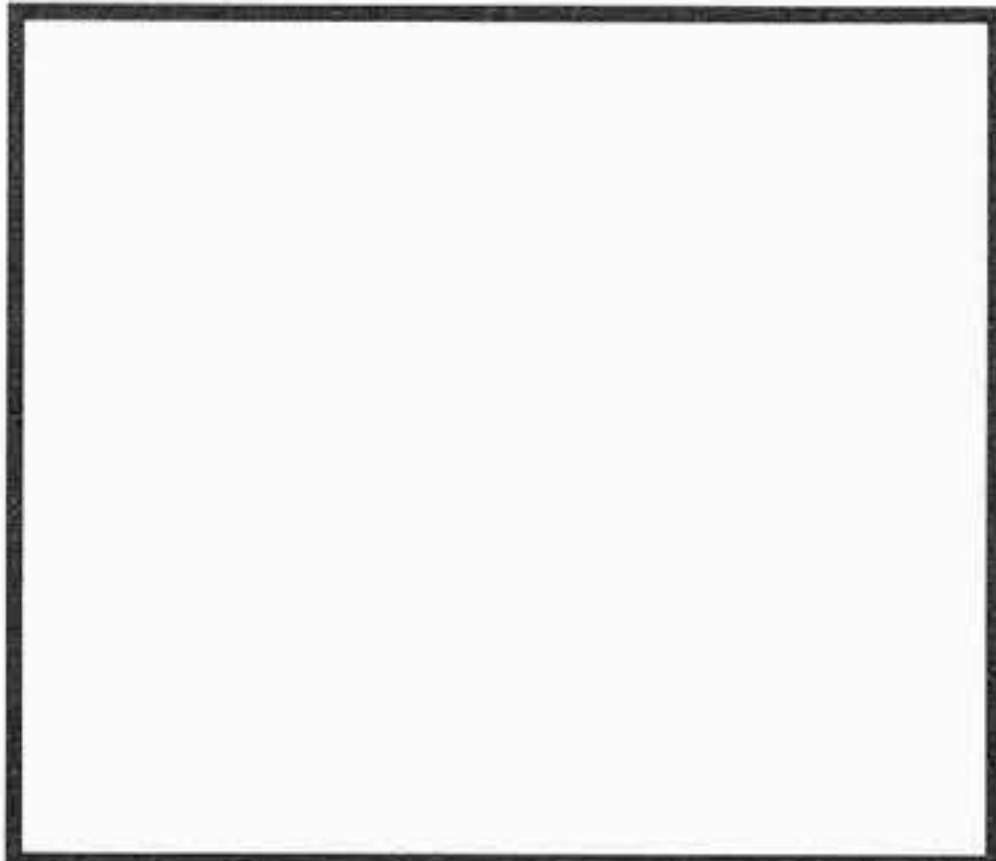
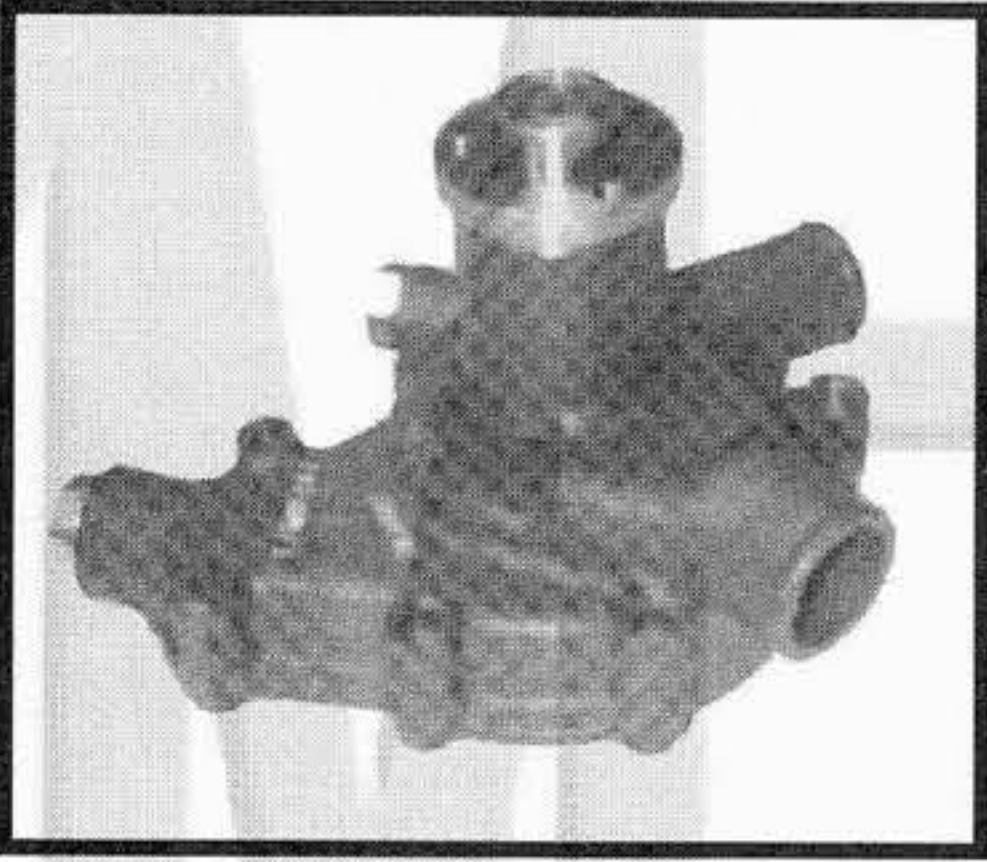
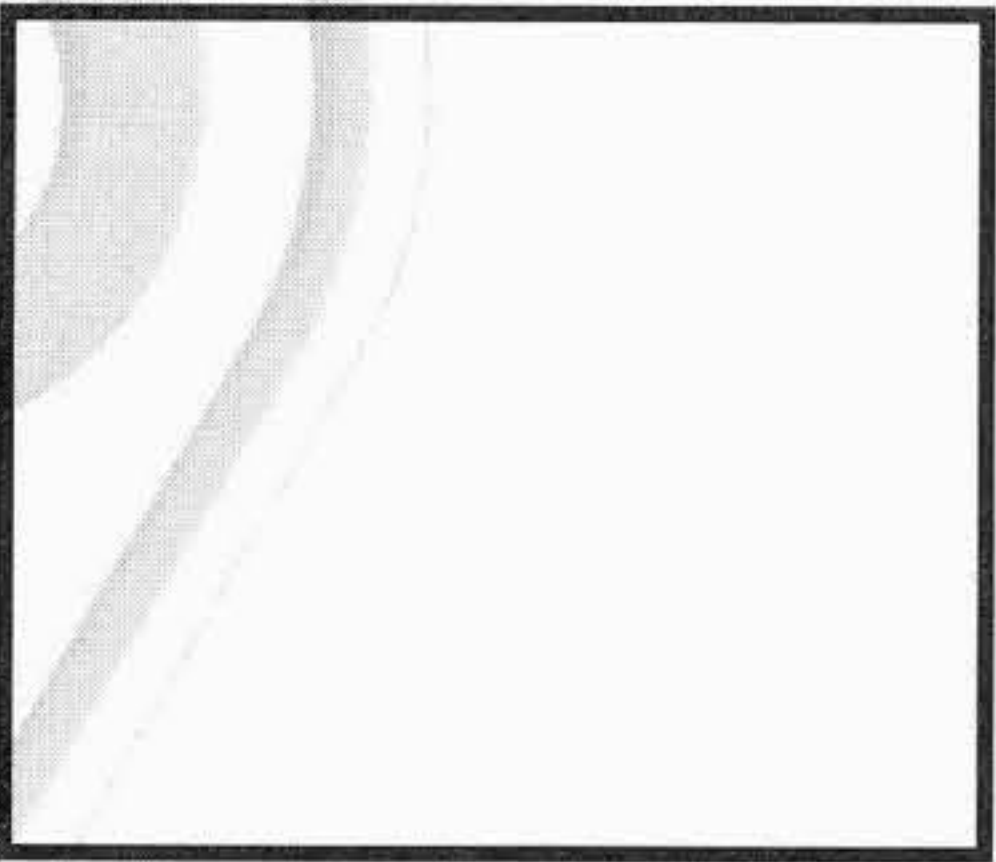
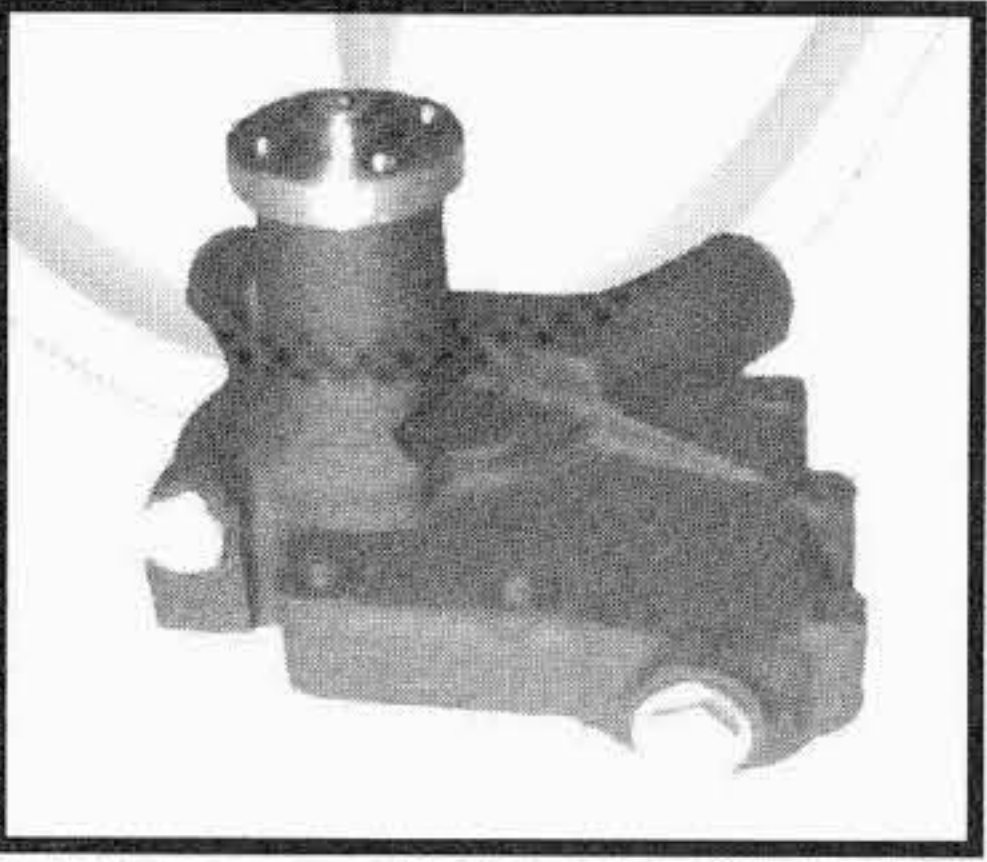
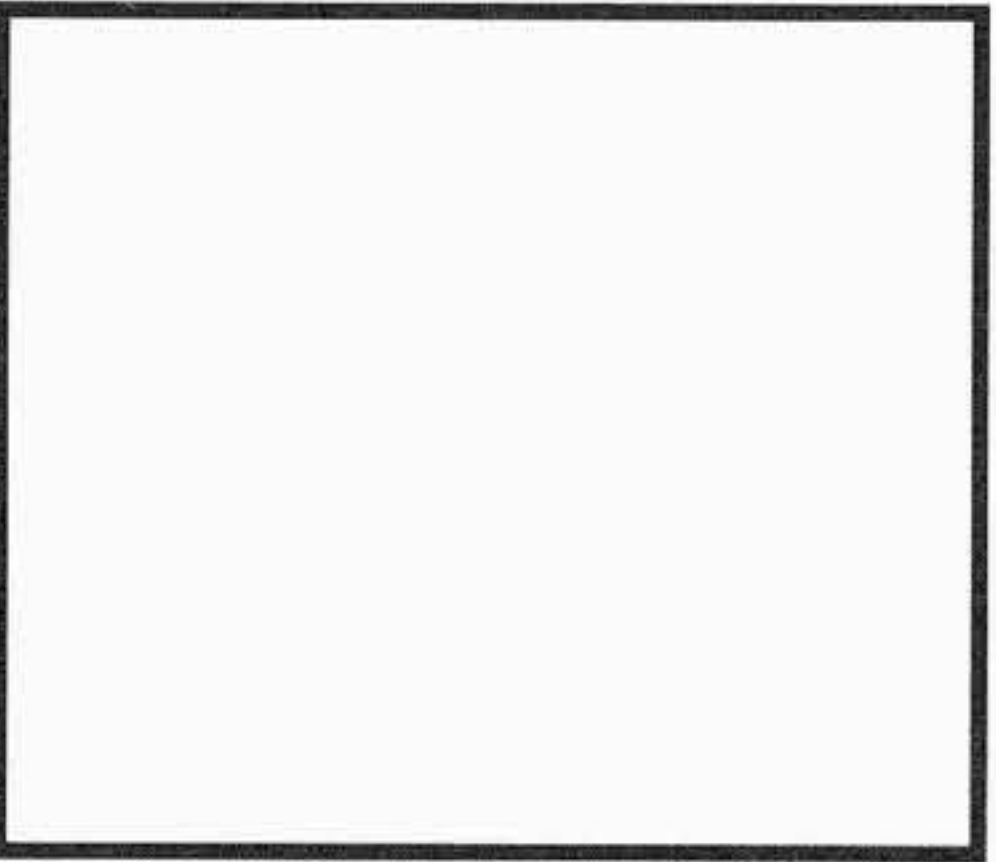
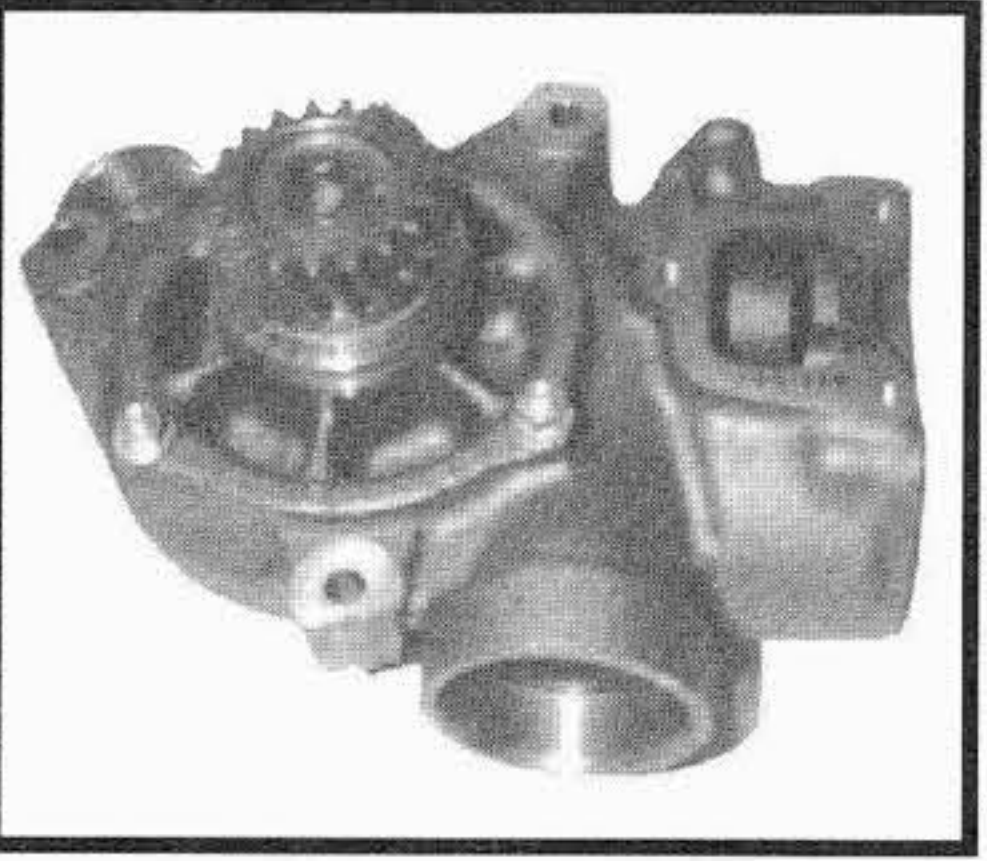
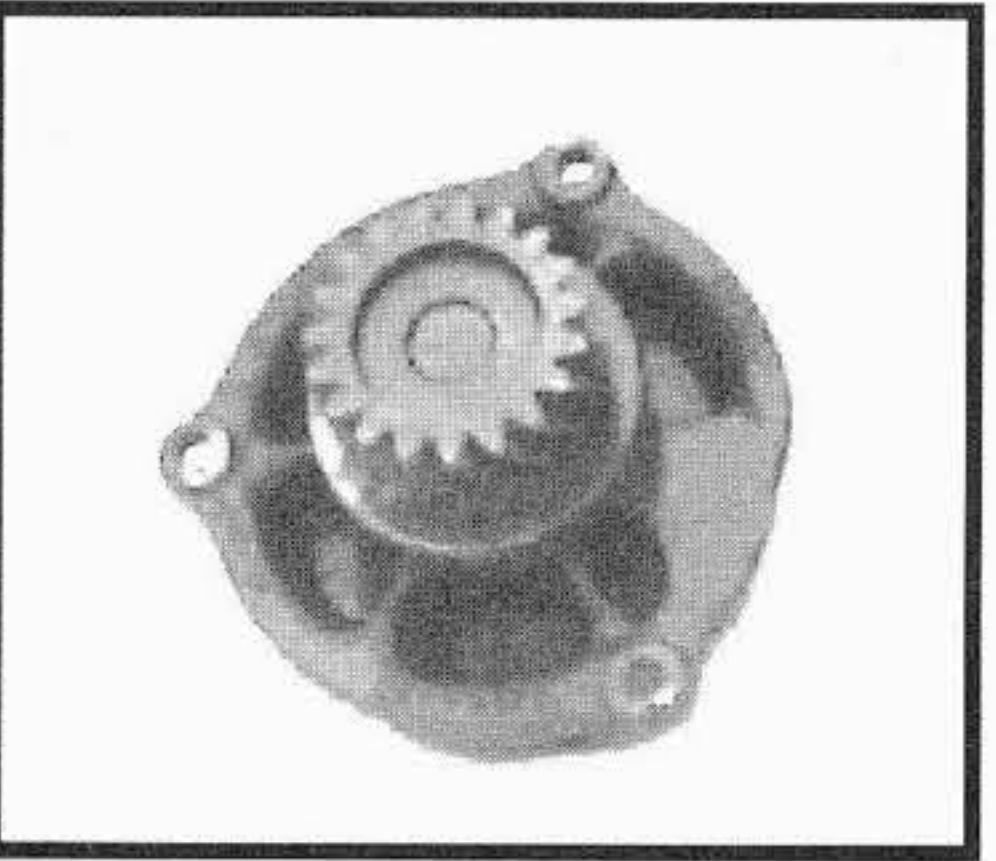

TIPO O MODELLO TYPE OU MODELE TYPE OR MODEL	MOTORE MOTEUR ENGINE	POMPA ACQUA POMPE A EAU WATER PUMP OMP REF. / O.EM. REF	KIT RIPARAZIONE NECESSAIRE DE REP. REPAIR KIT OMP REF. / O.EM. REF
650 - 650 DT - 655 - 655C  750 - 750 DT  805 C  850 - 850 S - 850 DT S	CO 3  CO 3  CO 3 / 75 var. 50  CO 3 / 80 var. 6/7	<p><b>221.485</b> 8829787</p> 	<p><b>222.262</b> 76031329</p> 
880 - 880 DT	CO 3 / 75 var.2 / 4 / 10	<p><b>201.490</b> 8829790</p> 	<p><b>202.041</b> 1909623</p> 
1300 - 1300 DT  1300 S - 1300 S DT	CP 3 / 100 var.16  CP 3 / 100 var.16	<p><b>201.604</b> 8829805</p> 	<p><b>222.267</b> 76032963</p> 
FX 300 - FX 375 - FX 450	8215.42	<p><b>196.485</b> 98447661</p>  <p><b>INGRANAGGIO / GEAR</b></p>	<p><b>216.419</b> 99445447</p>  <p><b>Ø = 65 mm N° denti = 19</b></p>

I ricambi non sono originali ma adattabili . Ogni riferimento originale é assolutamente indicativo .  
Spare parts are not original but perfectly suitable . Every original part number has to be considered for reference purpose only .

SUITABLE







**NEW HOLLAND**

**LAVERDA**

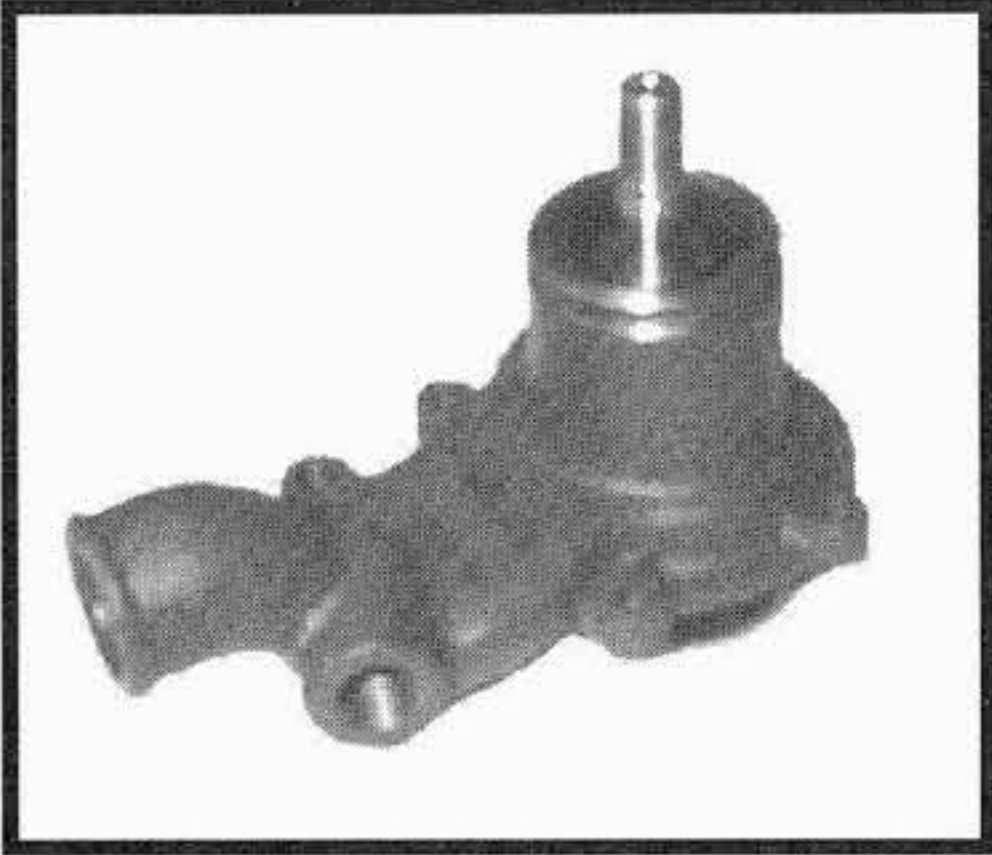
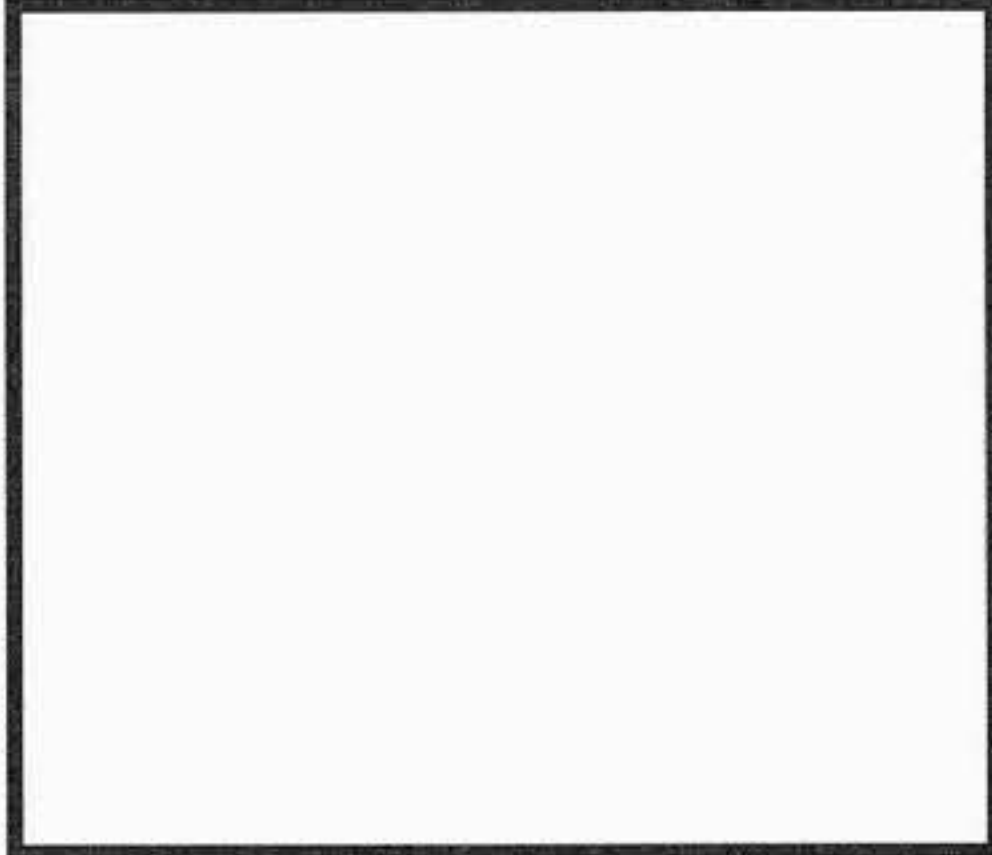
**Tel:+44(0)1925 850082 Fax: +(0)44 1925 850083**

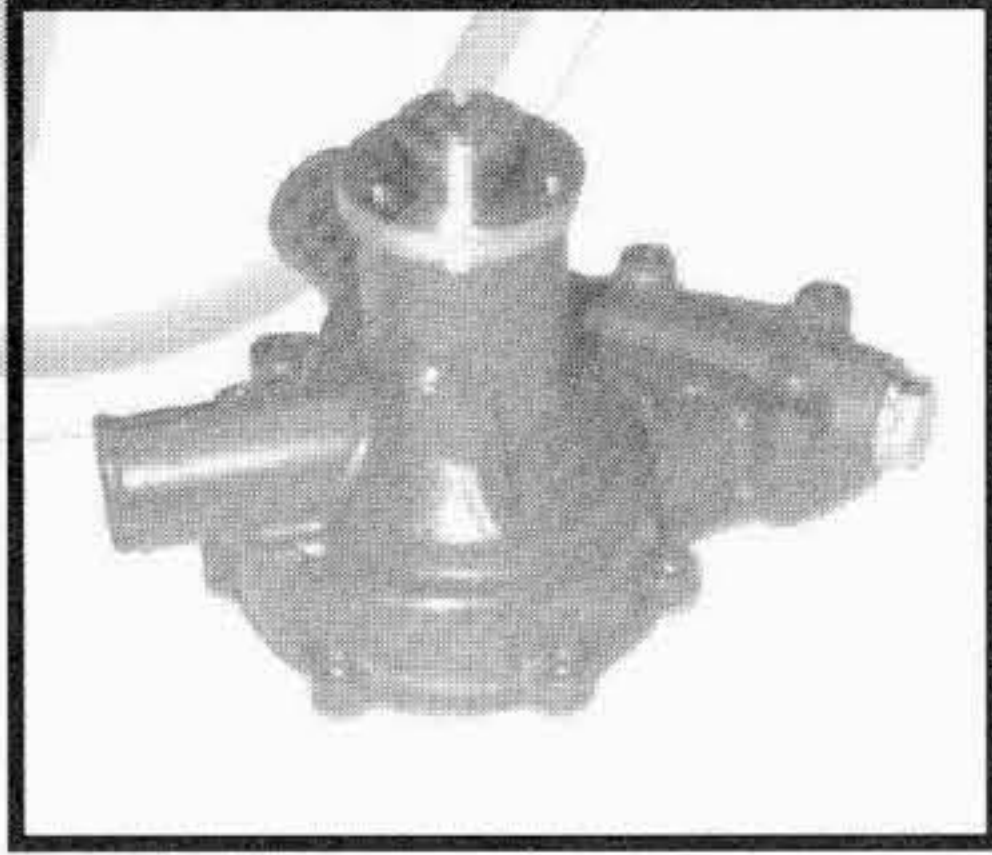
**www.spwaterpumps.co.uk**

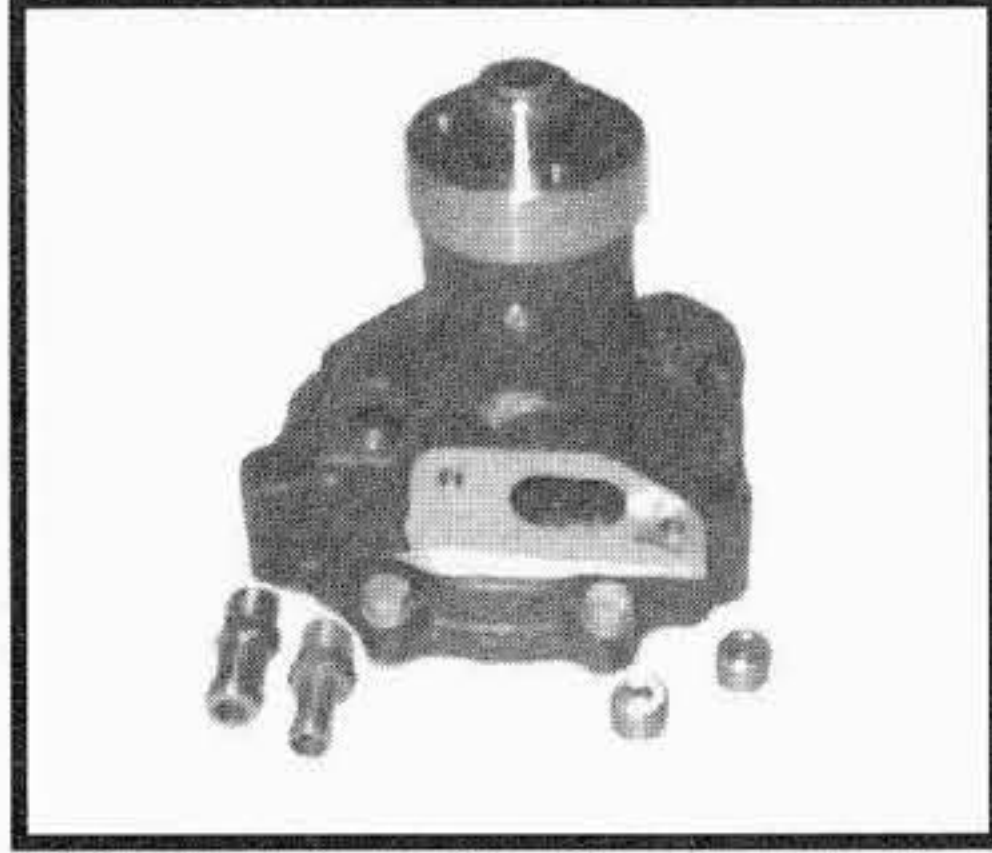

TIPO O MODELLO TYPE OU MODELE TYPE OR MODEL	MOTORE MOTEUR ENGINE	POMPA ACQUA POMPE A EAU WATER PUMP OMP REF. / O.EM. REF	KIT RIPARAZIONE NECESSAIRE DE REP. REPAIR KIT OMP REF. / O.EM. REF
M 84	4.236 - 4.248	<b>159.490</b> 4131A021 	<b>152.183</b> U7LW0032 
M 100	CO 2 D	<b>221.450</b> 577837 	<b>202.033</b> 1909625 
M 100	CO 3 / 70	<b>221.485</b> 8829787 	<b>222.262</b> 76031329 
M 112  3350  3450  3600	8065 I  8041 I  8061 I  8061 I	<b>196.319</b> 93191101 	<b>222.260</b> 76029352 

I ricambi non sono originali ma adattabili . Ogni riferimento originale é assolutamente indicativo .  
 Spare parts are not original but perfectly suitable . Every original part number has to be considered for reference purpose only .



SUITABLE

# NEW HOLLAND LAVERDA

Tel: +44(0)1925 850082 Fax: +(0)44 1925 850083

www.spwaterpumps.co.uk

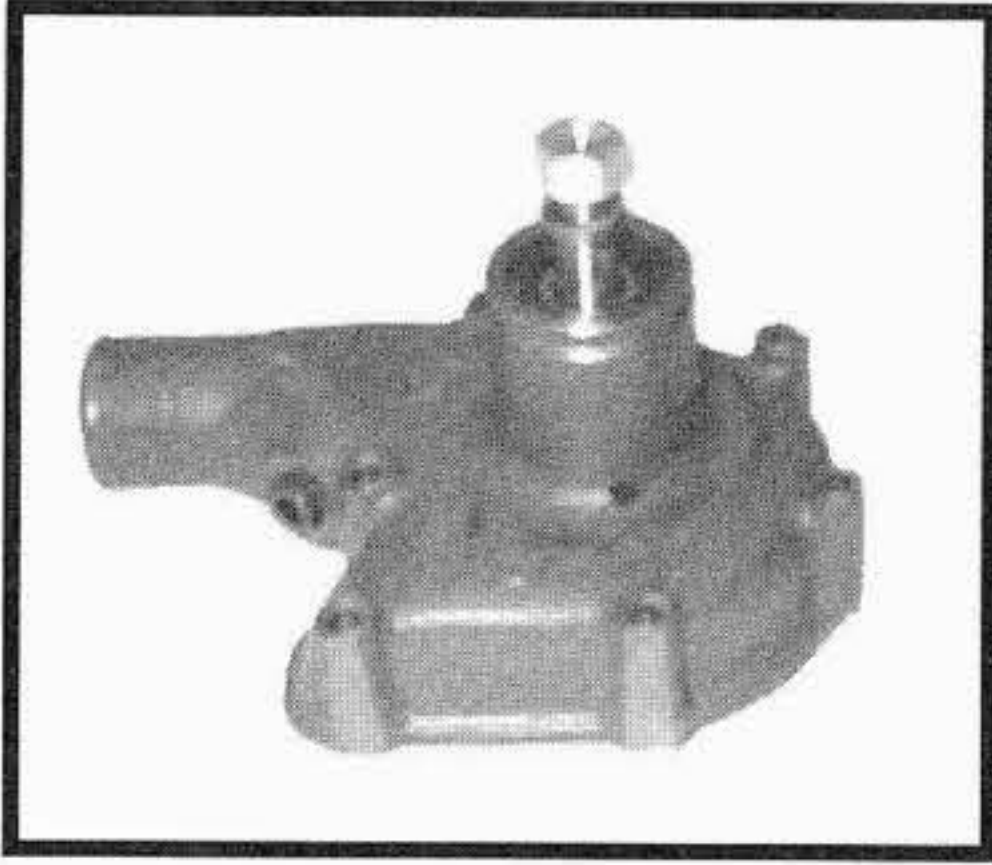
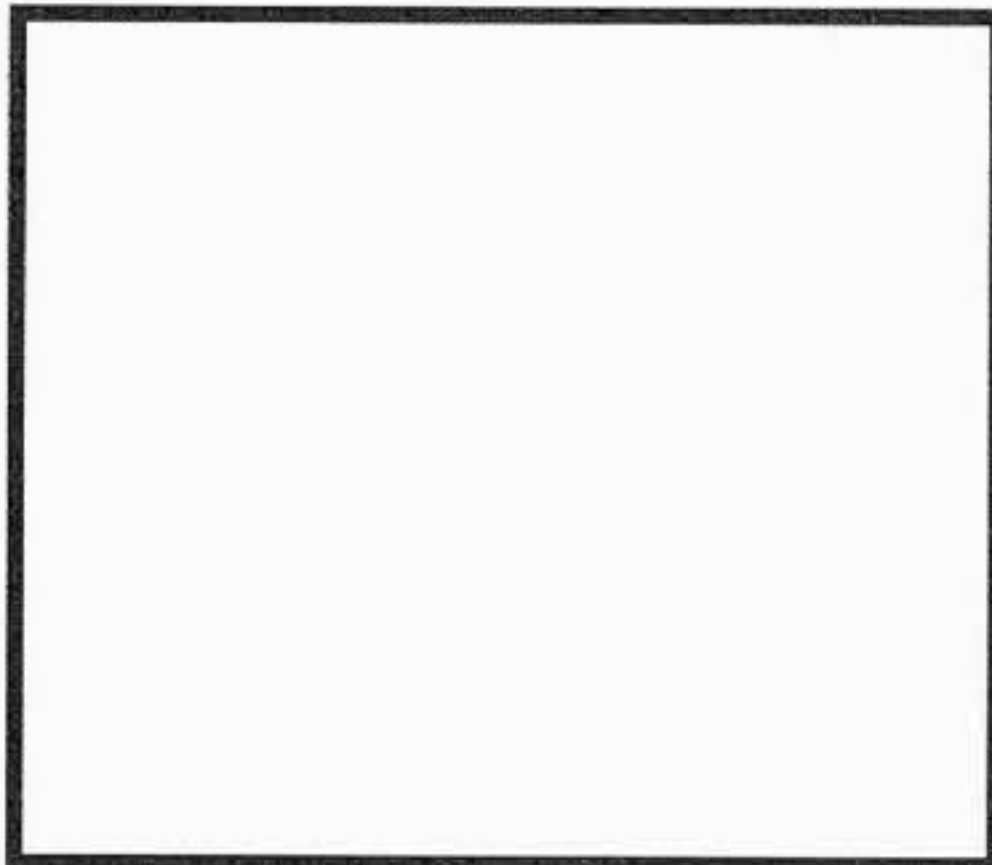
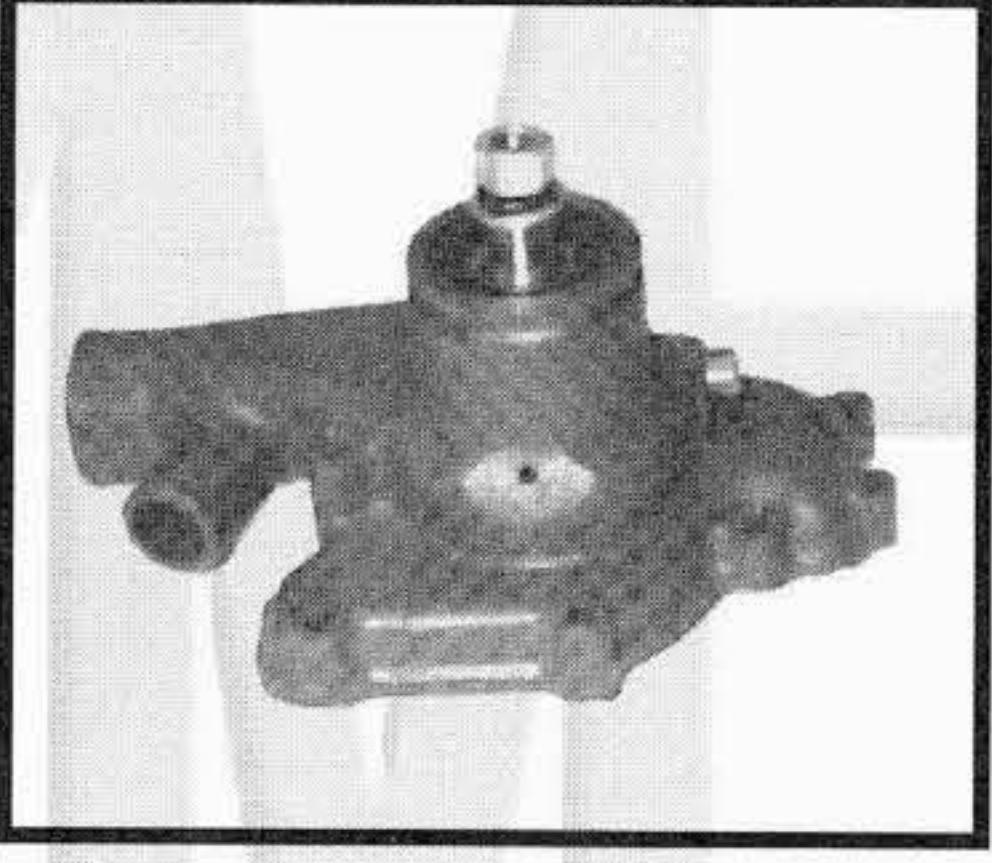
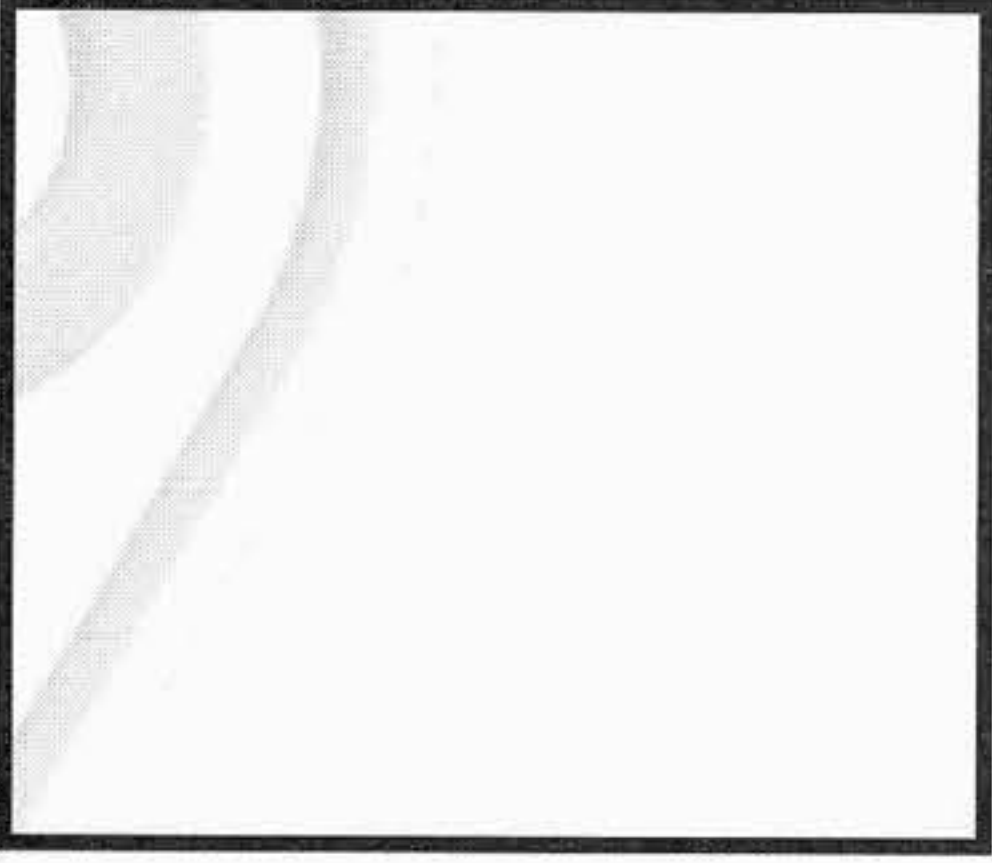
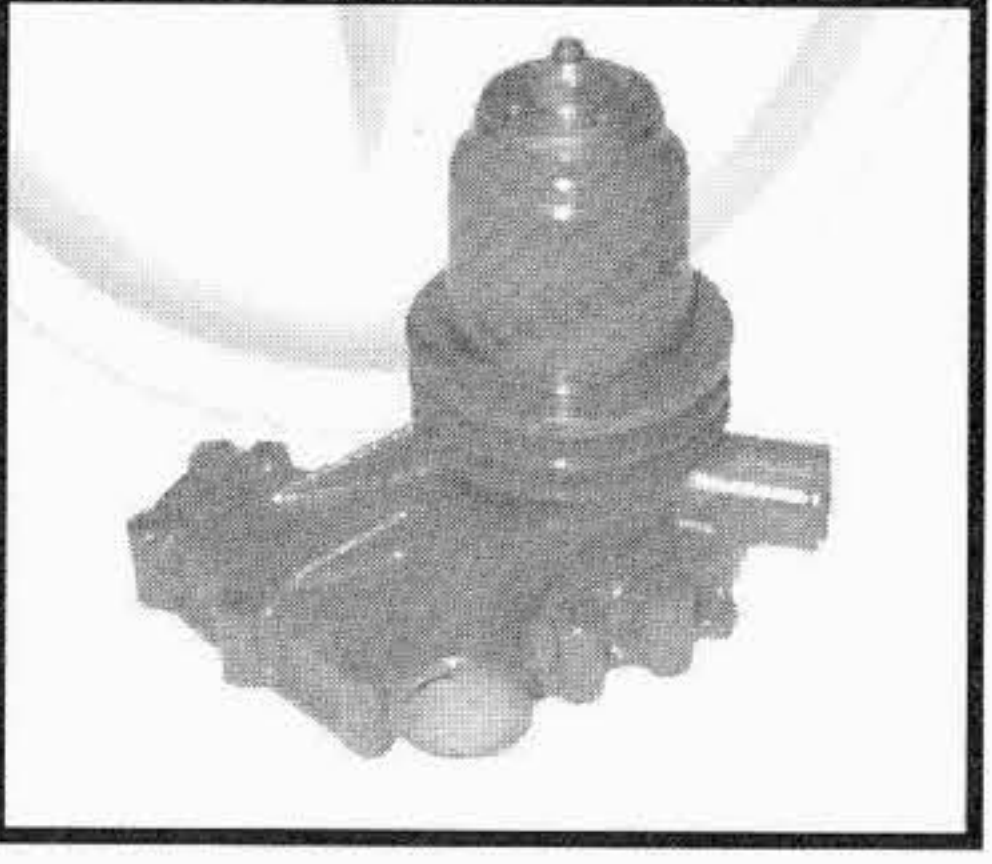
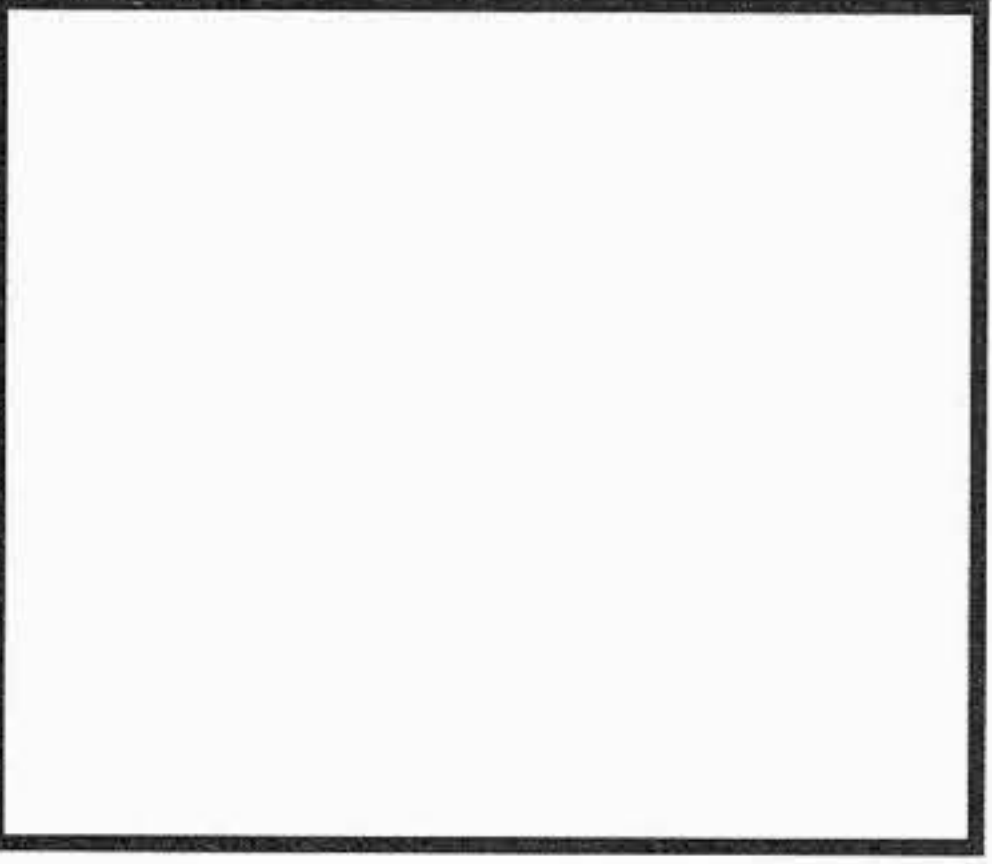

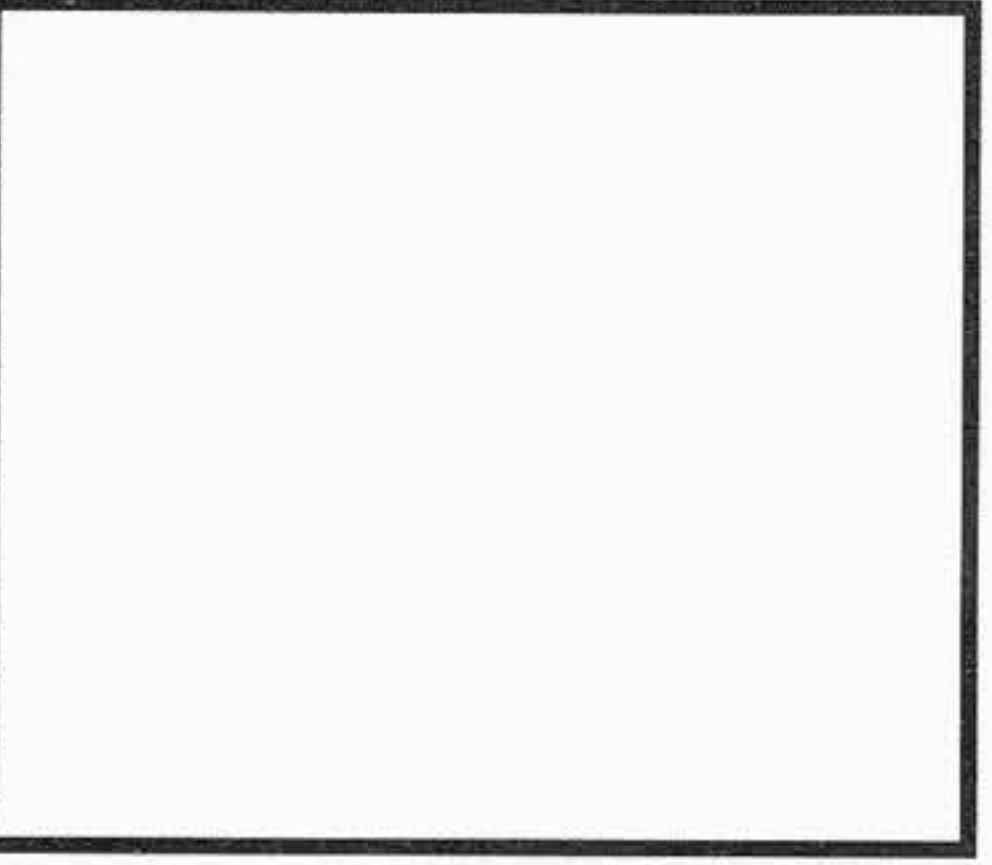
TIPO O MODELLO TYPE OU MODELE TYPE OR MODEL	MOTORE MOTEUR ENGINE	POMPA ACQUA POMPE A EAU WATER PUMP	KIT RIPARAZIONE NECESSAIRE DE REP. REPAIR KIT
		OMP REF. / O.EM. REF	OMP REF. / O.EM. REF
M 120 - M 132	6.354	<b>159.090</b> 41313045 	<b>152.097</b> U7LW0009 
M 120 - M 132	6.372.4	<b>159.260</b> 41313047 	<b>252.243</b> U7LW0020 
M 150 - M 152	CP 3 I var. 1	<b>211.520</b> 8829779 	<b>212.047</b> --- 
MX 240 - MX 240 R	82101002	<b>191.300</b> 4606023 	<b>202.270</b> 76031213 

I ricambi non sono originali ma adattabili . Ogni riferimento originale é assolutamente indicativo .  
 Spare parts are not original but perfectly suitable . Every original part number has to be considered for reference purpose only .



SUITABLE

# NEW HOLLAND LAVERDA

Tel: +44(0)1925 850082 Fax: +(0)44 1925 850083

www.spwaterpumps.co.uk

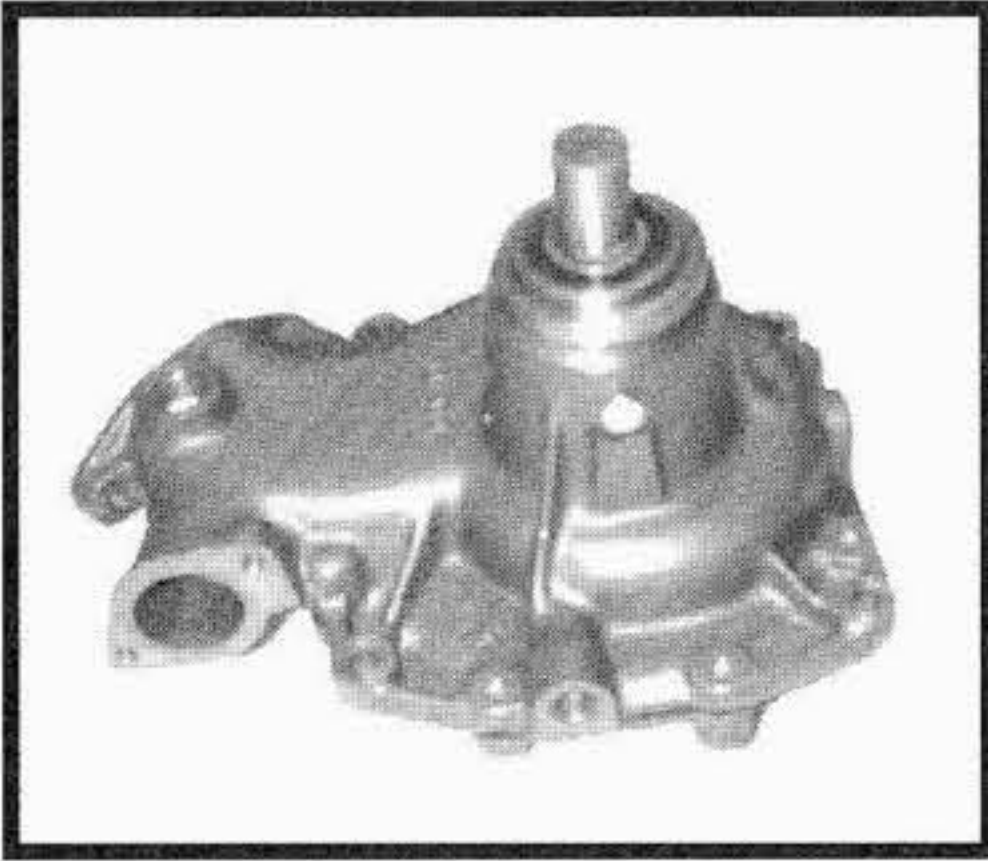
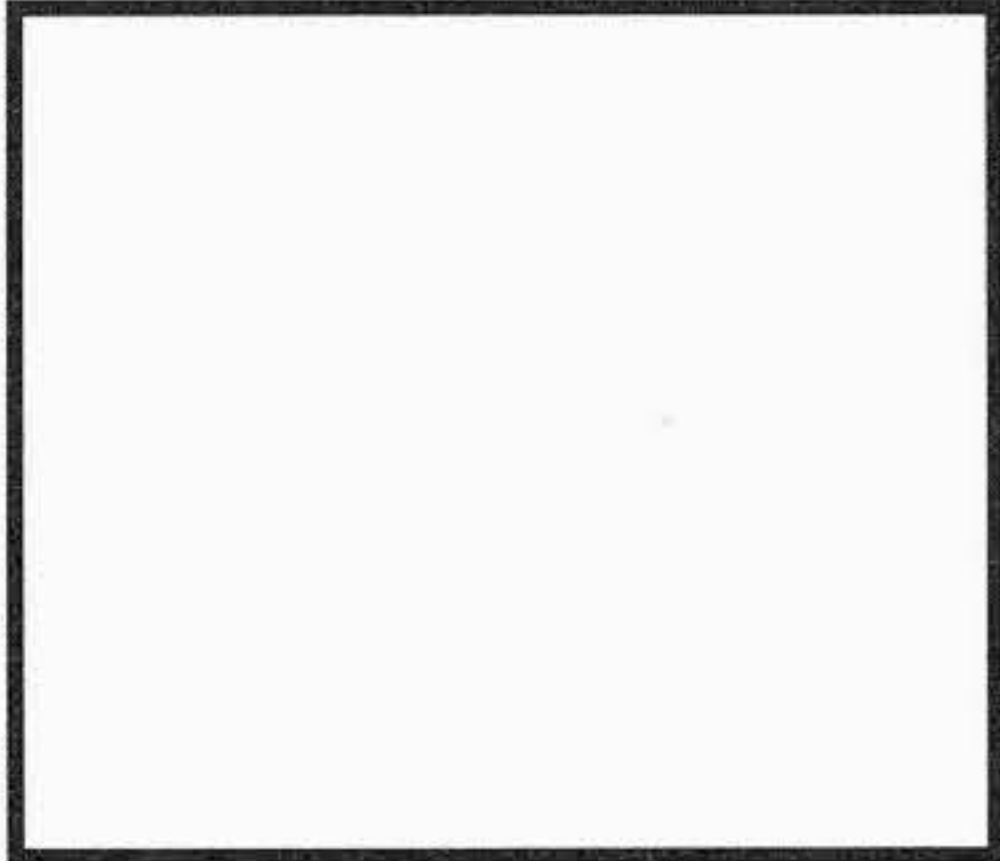
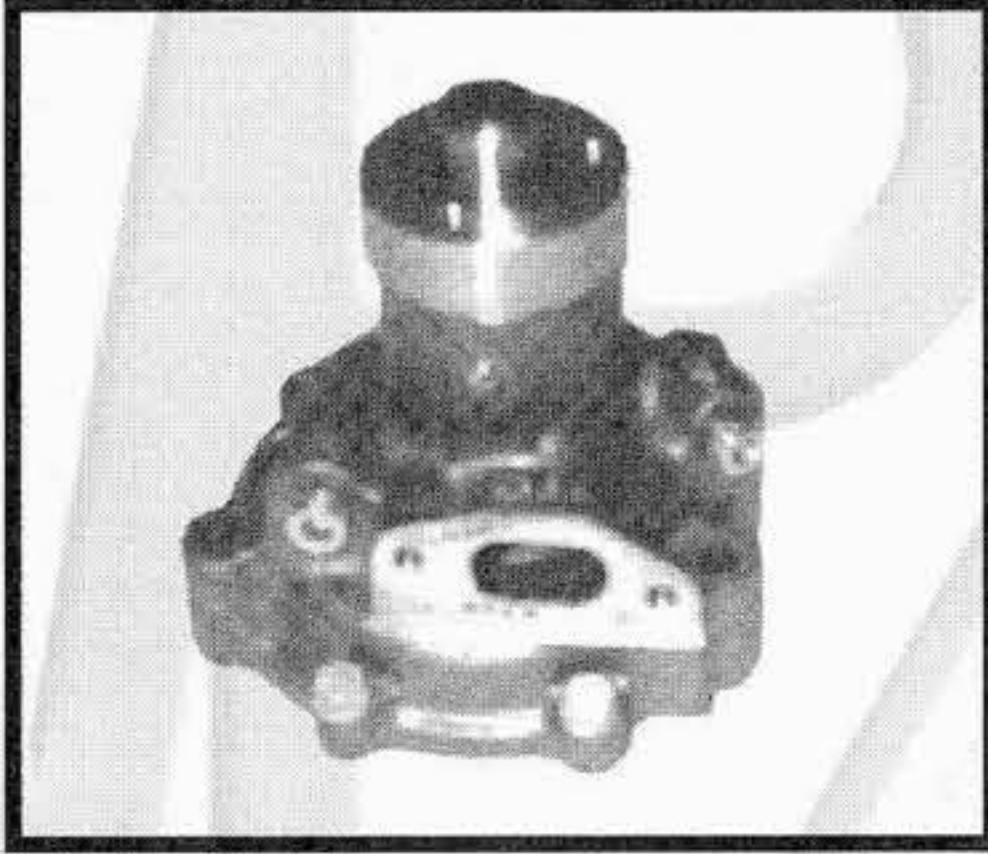
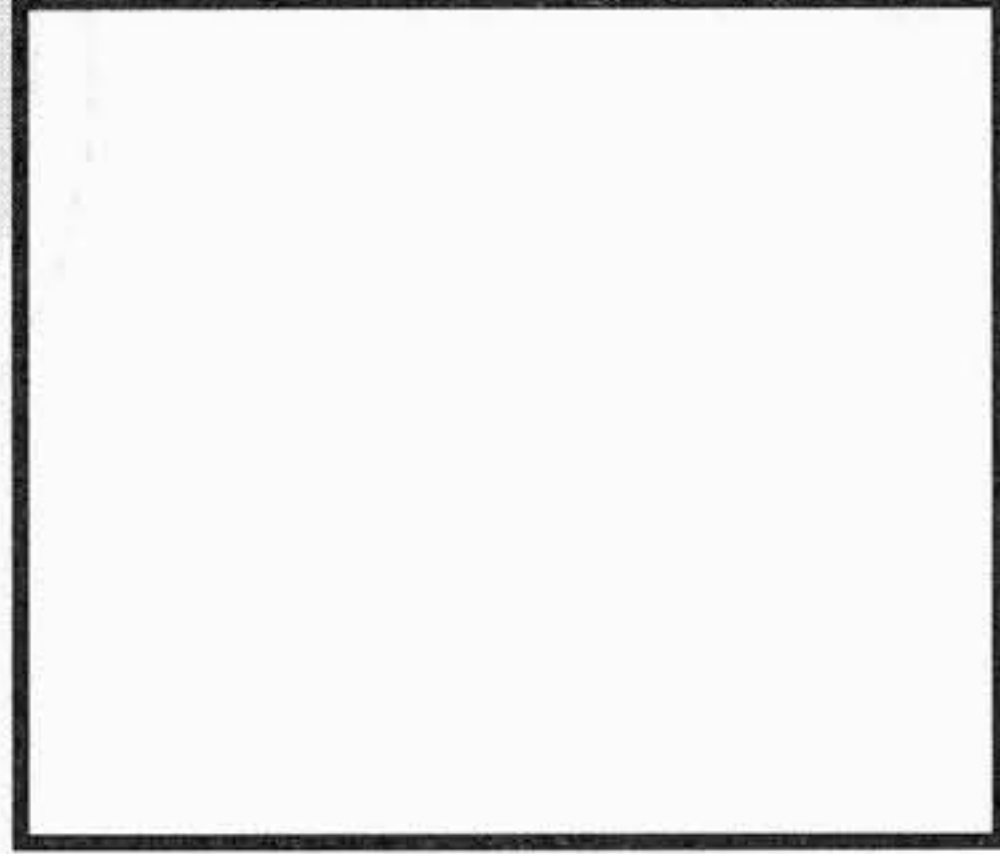
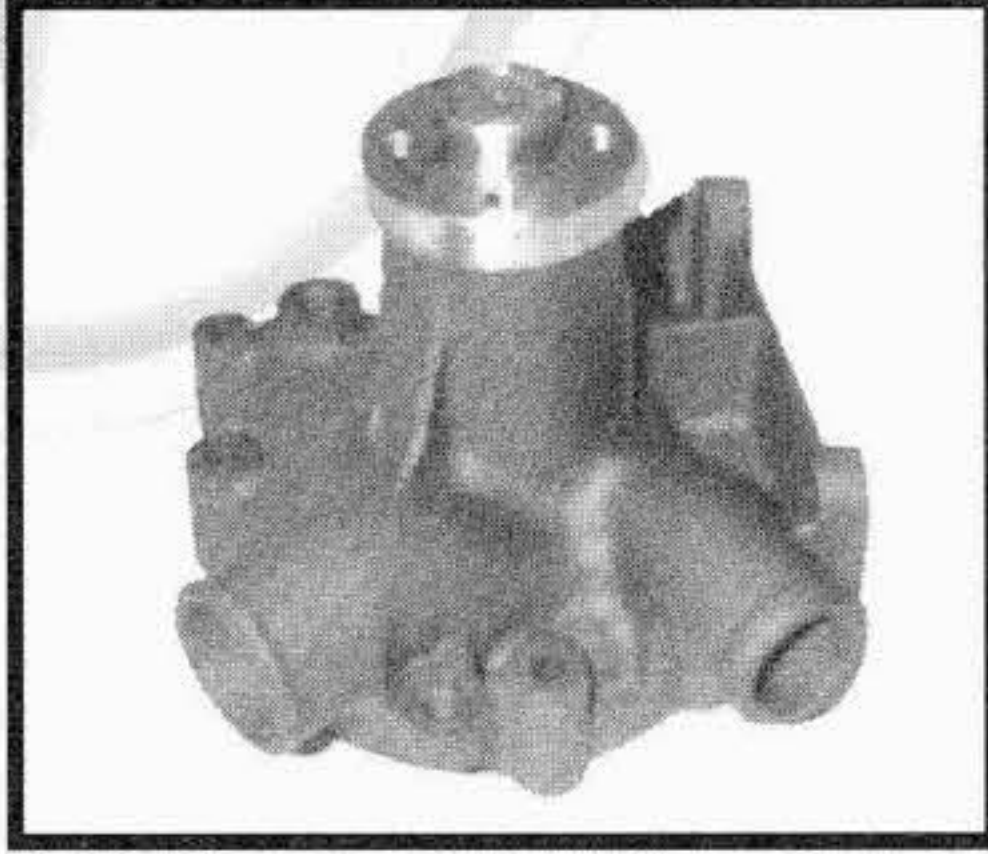
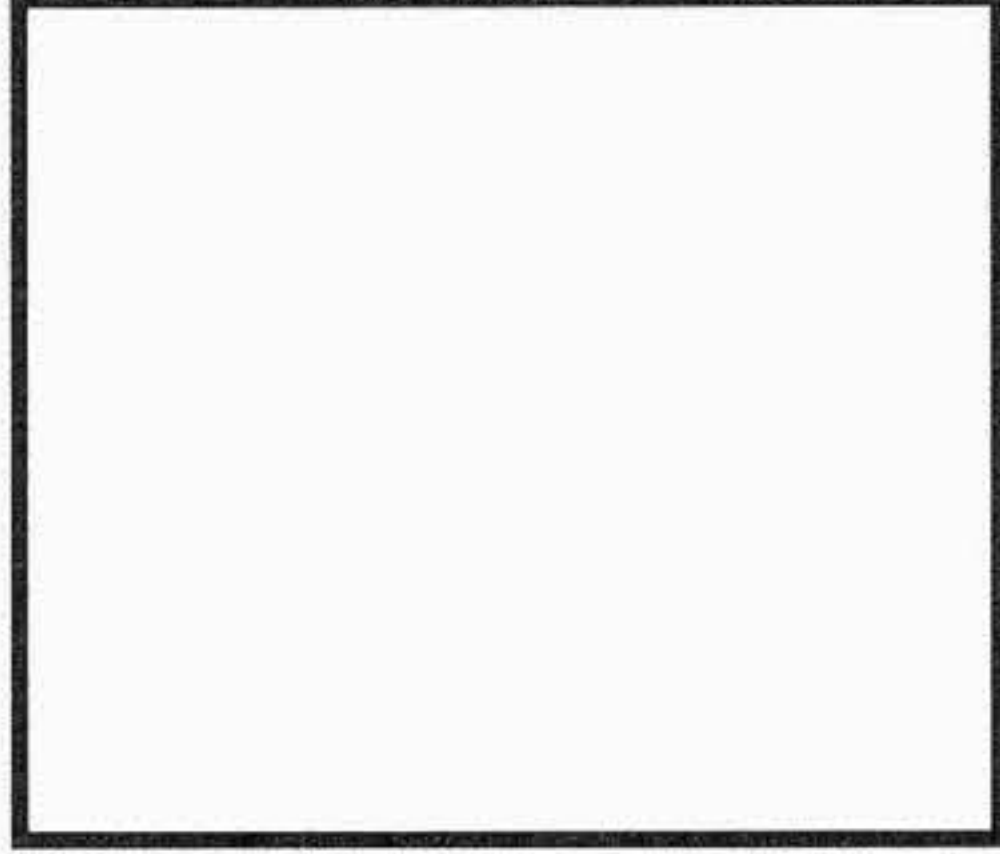
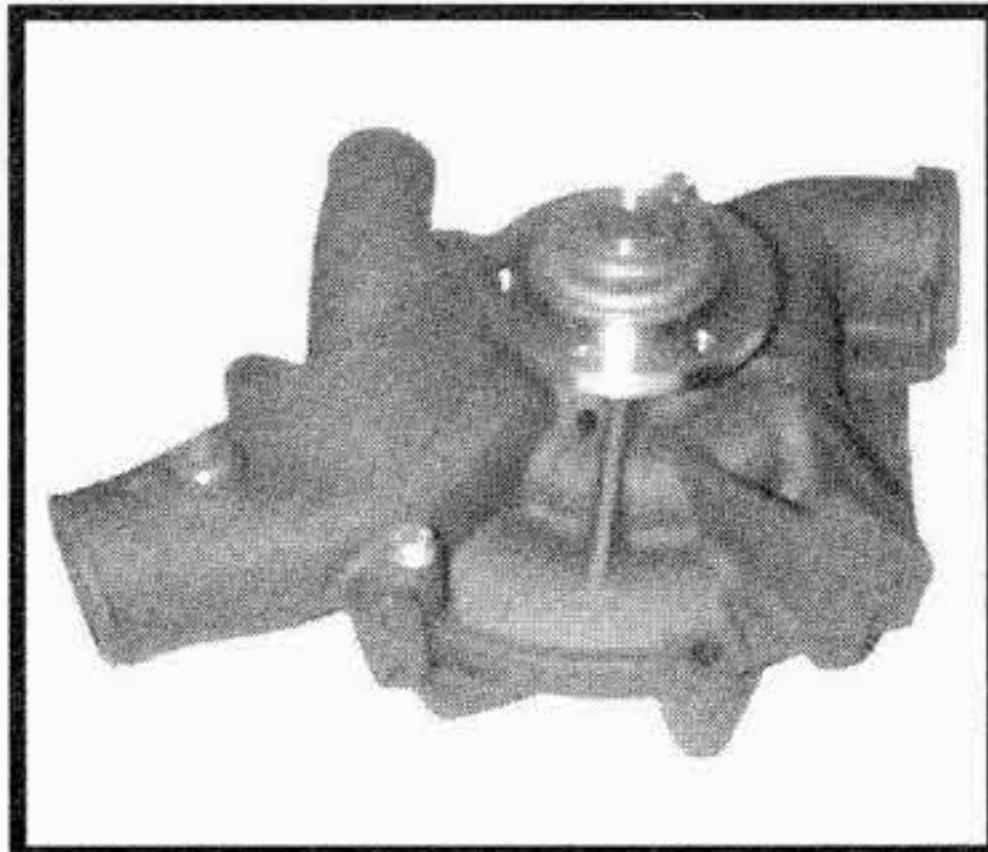
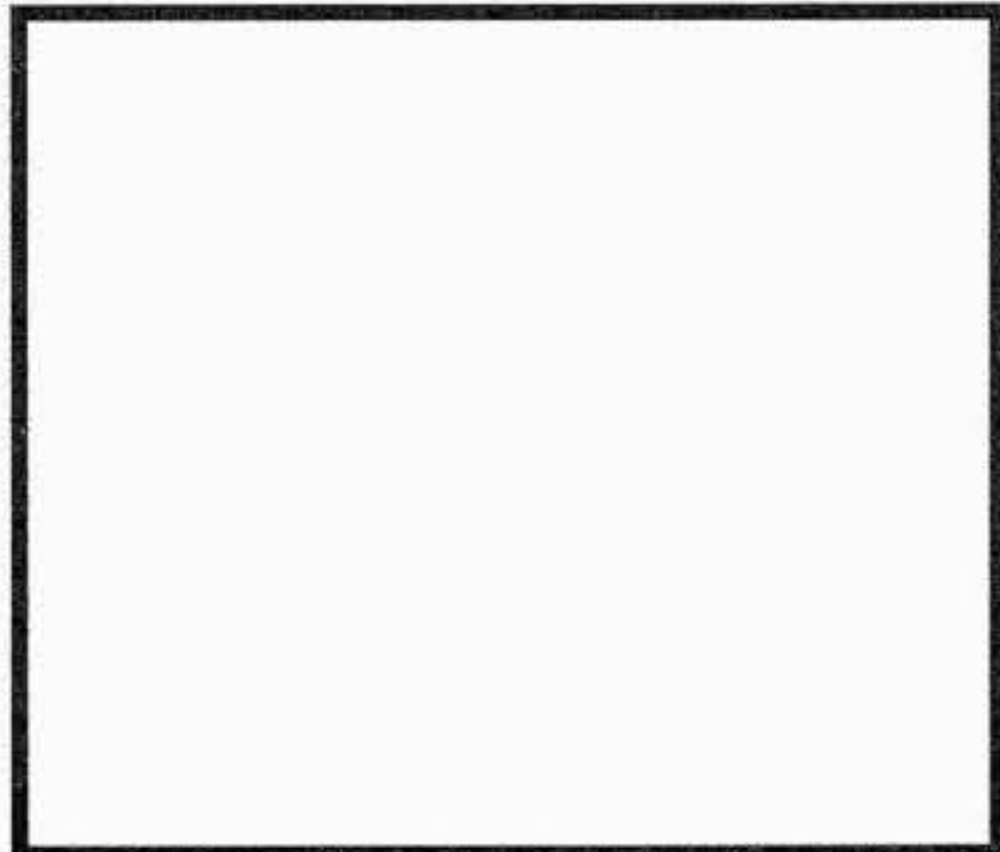

TIPO O MODELLO TYPE OU MODELE TYPE OR MODEL	MOTORE MOTEUR ENGINE	POMPA ACQUA POMPE A EAU WATER PUMP OMP REF. / O.EM. REF	KIT RIPARAZIONE NECESSAIRE DE REP. REPAIR KIT OMP REF. / O.EM. REF
MX 300 - MX 300 R	8210 SI 02	<p><b>191.310</b> 4710552 SENZA PULEGGIA / WITHOUT PULLEY</p>  <p><b>196.355</b> 61088139 CON PULEGGIA / WITH PULLEY</p>	<p><b>192.019</b> 1902655</p> 
3300 - 3300 R 3400 - 3400 R 3500 - 3500 R 3550 - 3550 R 3550 AL 3650 - 3650 R 3750 - 3750 R	8041 I 05.004 8061 I 05.0041 8061 I 05.003 8061 SI 05.002 8061 SI 25.002 8061 SI 05.002 8061 SI 25.002	<p><b>206.265</b> 4813370</p> 	<p><b>222.264</b> 1940105</p> 
3700  3790 - 3790 R	8361 I  8361 SI 10.003	<p><b>206.200</b> 4796537</p> 	<p><b>222.268</b> 1940119</p> 
3900	8280 I	<p><b>196.015</b> 4764156</p> 	<p><b>202.272</b> 76032965</p> 

I ricambi non sono originali ma adattabili . Ogni riferimento originale é assolutamente indicativo .  
 Spare parts are not original but perfectly suitable . Every original part number has to be considered for reference purpose only .

SUITABLE

# NEW HOLLAND FORD

Tel: +44(0)1925 850082 Fax: +(0)44 1925 850083

www.spwaterpumps.co.uk

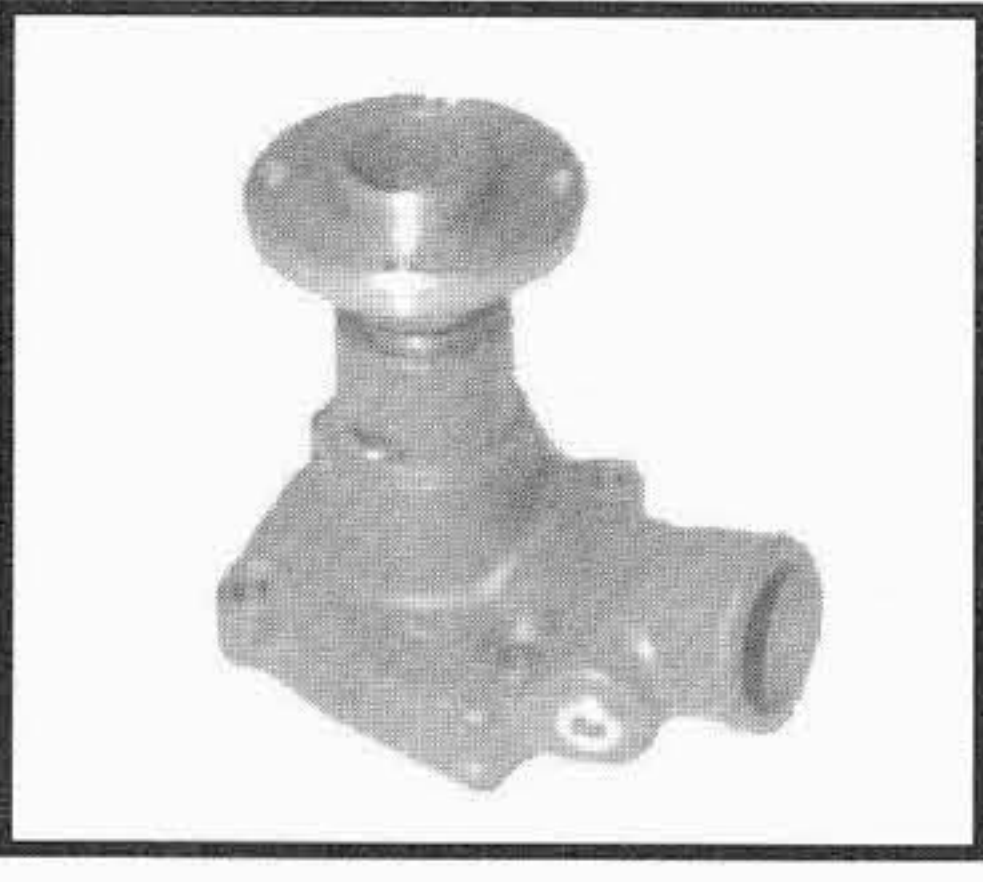
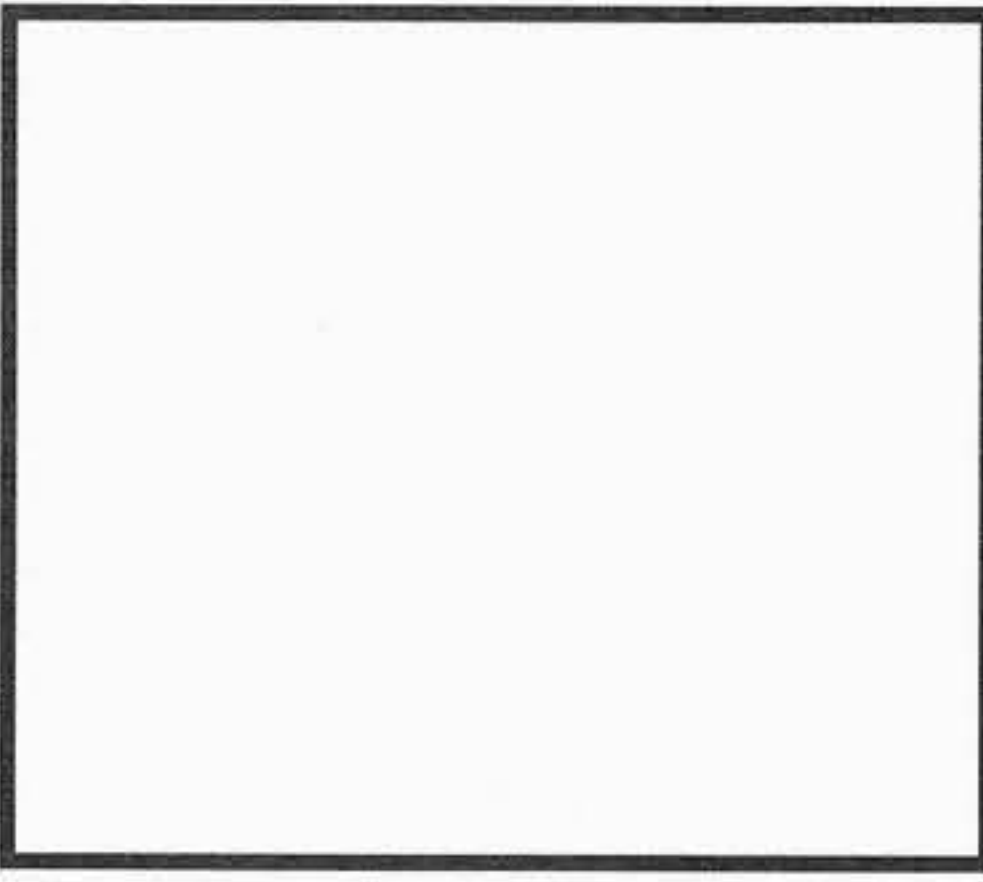
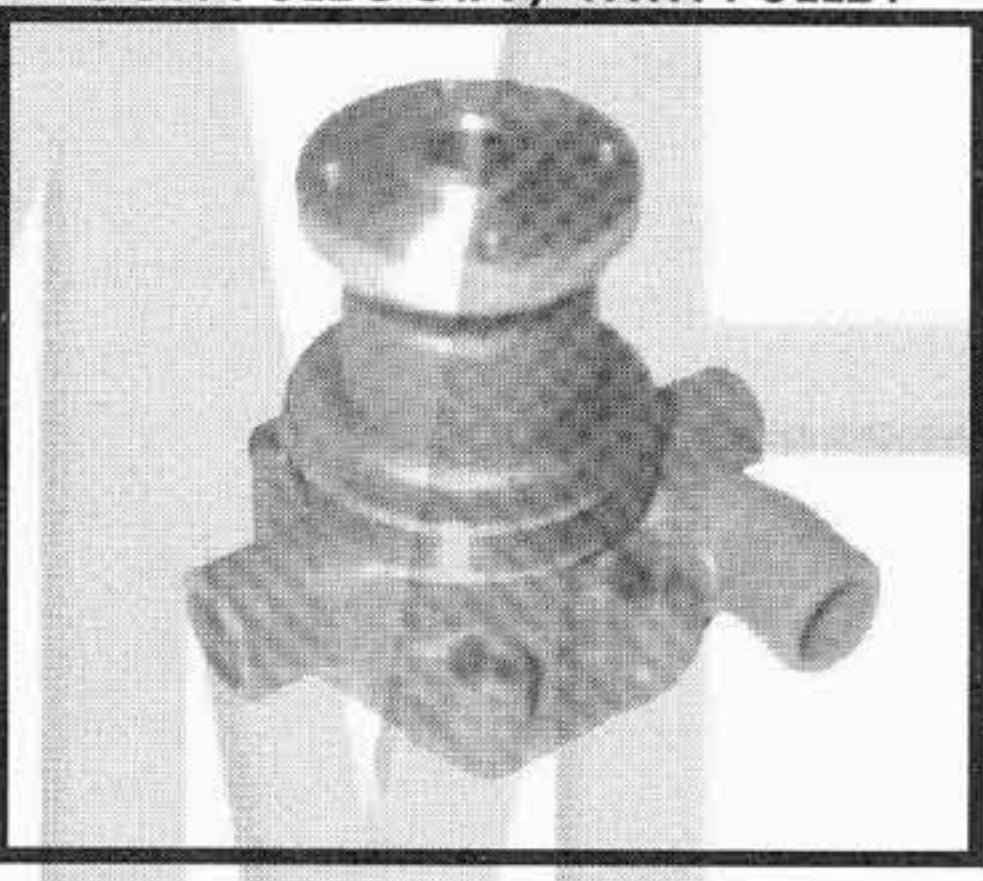
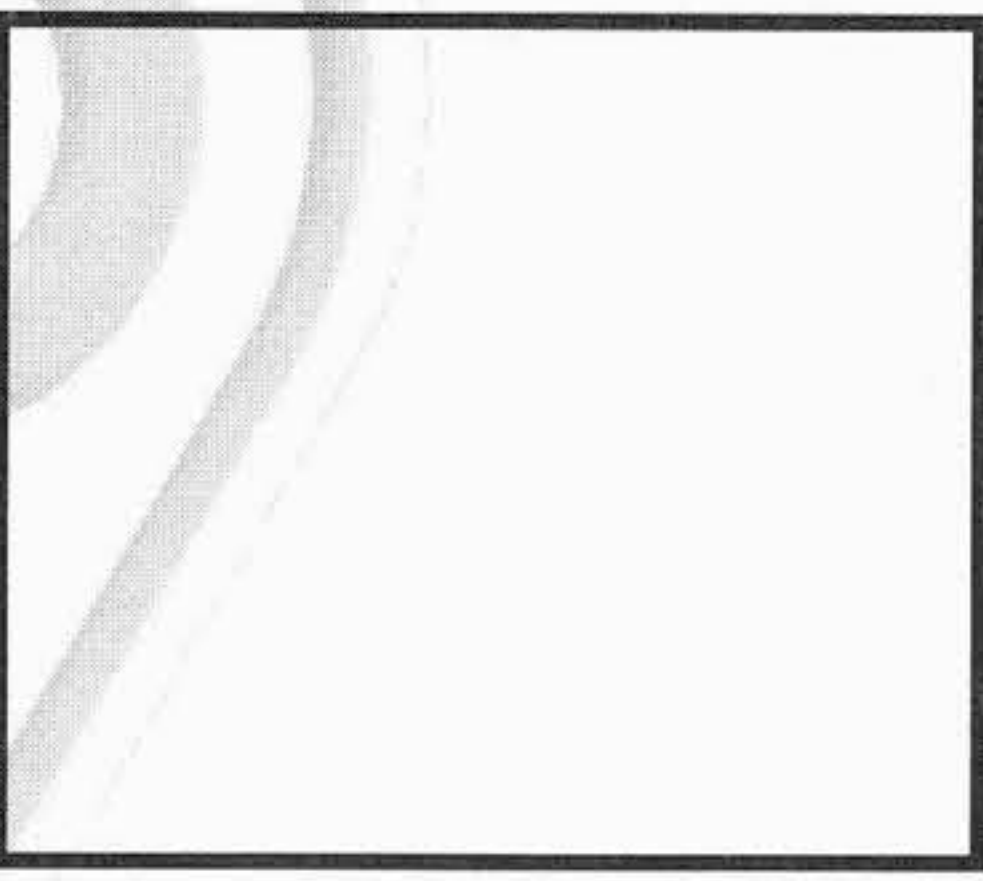
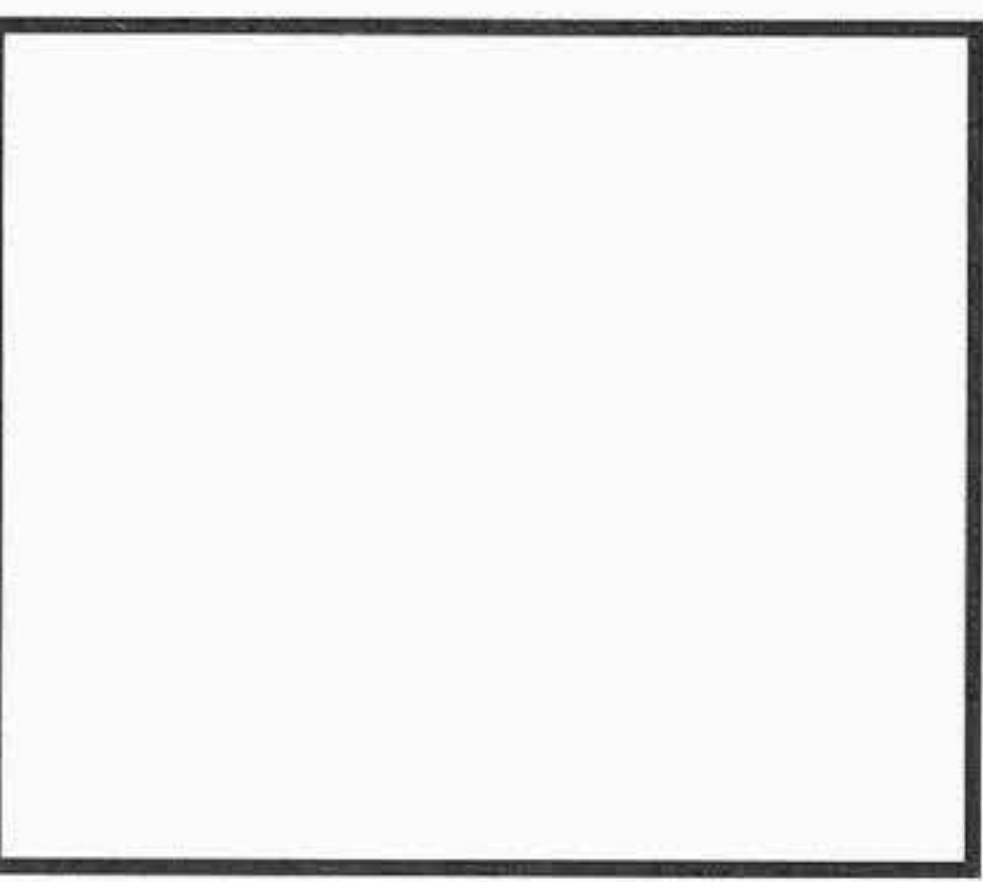
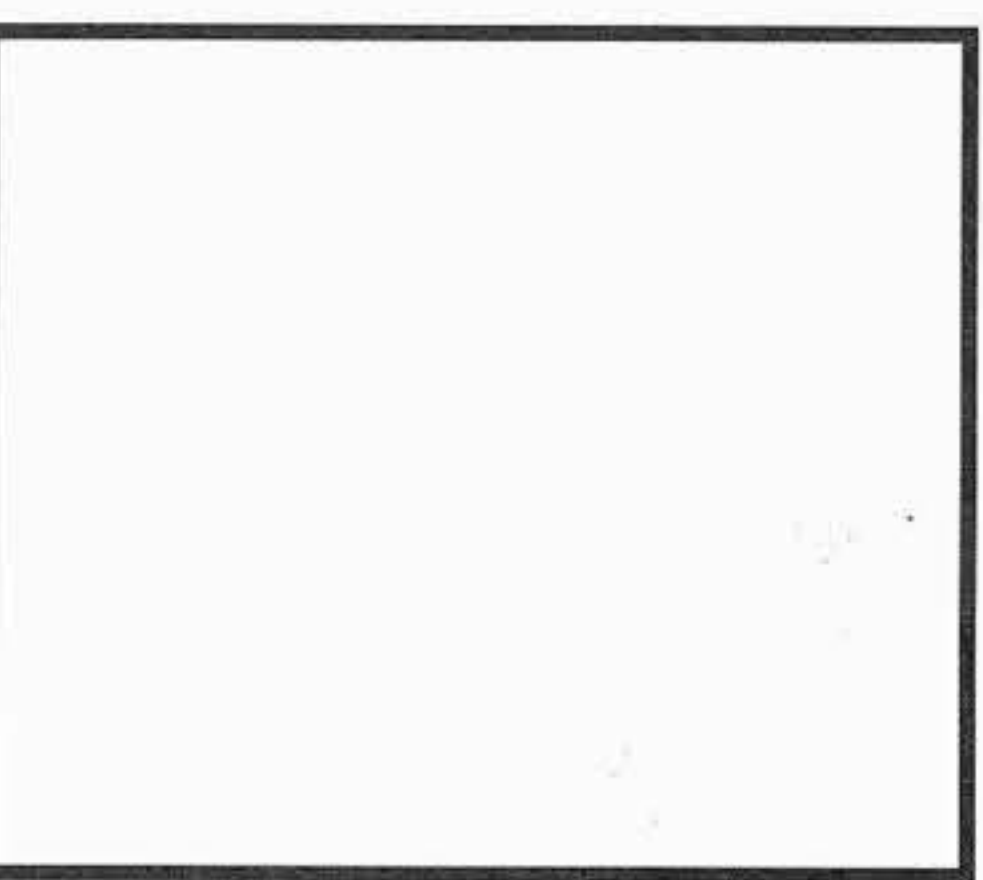

TIPO O MODELLO TYPE OU MODELE TYPE OR MODEL	MOTORE MOTEUR ENGINE	POMPA ACQUA POMPE A EAU WATER PUMP	KIT RIPARAZIONE NECESSAIRE DE REP. REPAIR KIT
MAJOR MK 1  MAJOR MK 11 (1952/1960)  SUPER MAJOR (1960/1967)	Ford	<p><b>164.010</b> E1ADKN8501C 81711728</p> 	<p><b>162.137</b> E1ADKN8591 81711772</p> 
DEXTA - SUPER DEXTA	Perkins 3.144	<p><b>164.080</b> 957E8501B CON PULEGGIA / WITH PULLEY</p>  <p><b>159.375</b> U5MW0057 SENZA PULEGGIA / WITHOUT PULLEY</p>	<p><b>162.130</b> E158Z9</p> 
2000 - 2100 - 2110 - 2120 2150 - 2300 - 2310 - 3000 3055 - 3100 - 3120 - 3150 3190 - 3300 - 3310 - 3400 3500 - 3550 - 4000 - 4100 --> 71 4110 - 4140 - 4190 - 4200 4400 - 4410 - 4500 - 5000 5100 - 5190 - 5200 - 7000 7110 - 7200	Ford 3 - 4 cyl.	<p>--- D5NN8501E CON BASAMENTO / WITH BACKPLATE</p> <div data-bbox="904 1850 1361 2262" style="border: 1px solid black; padding: 5px;"> <p>Questo complessivo pompa acqua è stato sostituito con il tipo L' Ensemble de pompe d' eau a ete remplacè par le modele This complex of water pump has been replaced by the type <b>D8NN8501UC - 164.087</b> Questa pagina resta valida per i ricambi Cete page reste valable pour les pièces de rechange . This page remain valid for the spare parts</p> </div> <p>--- DHPN8A513C SENZA BASAMENTO / WITHOUT BACKPLATE</p>	<p><b>162.147</b> DJPN8591A 83914014</p>  <p>girante / impeller Ø 89 mm</p>
2000 - 2100 - 2110 - 2120 2150 - 2300 - 2310 - 3000 3055 - 3100 - 3120 - 3150 3190 - 3300 - 3310 - 3400 3500 - 3550 - 4000 - 4100 --> 71 4110 - 4140 - 4190 - 4200 4400 - 4410 - 4500 - 5000 5100 - 5190 - 5200 - 7000 7110 - 7200  2600 - 3600 - 3900 - 4100 4600 - 5600 - 5700 - 6600 --> 81 6700 - 7600 - 7700  550 ---> 1975 / 1983	Ford 3 - 4 cyl.  Ford 3 - 4 cyl.	<p>--- D8NN8501UA CON BASAMENTO / WITH BACKPLATE</p> <div data-bbox="904 2499 1361 2910" style="border: 1px solid black; padding: 5px;"> <p>Questo complessivo pompa acqua è stato sostituito con il tipo L' Ensemble de pompe d' eau a ete remplacè par le modele This complex of water pump has been replaced by the type <b>D8NN8501UC - 164.087</b> Questa pagina resta valida per i ricambi Cete page reste valable pour les pièces de rechange . This page remain valid for the spare parts</p> </div> <p>--- DHPN8A513F SENZA BASAMENTO / WITHOUT BACKPLATE</p>	<p><b>162.148</b> EAPN8591C 83914015</p>  <p>girante / impeller Ø 104 mm</p>

I ricambi non sono originali ma adattabili . Ogni riferimento originale é assolutamente indicativo .  
 Spare parts are not original but perfectly suitable . Every original part number has to be considered for reference purpose only .

SUITABLE





**NEW HOLLAND**

**FORD**

**Tel:+44(0)1925 850082 Fax: +(0)44 1925 850083**

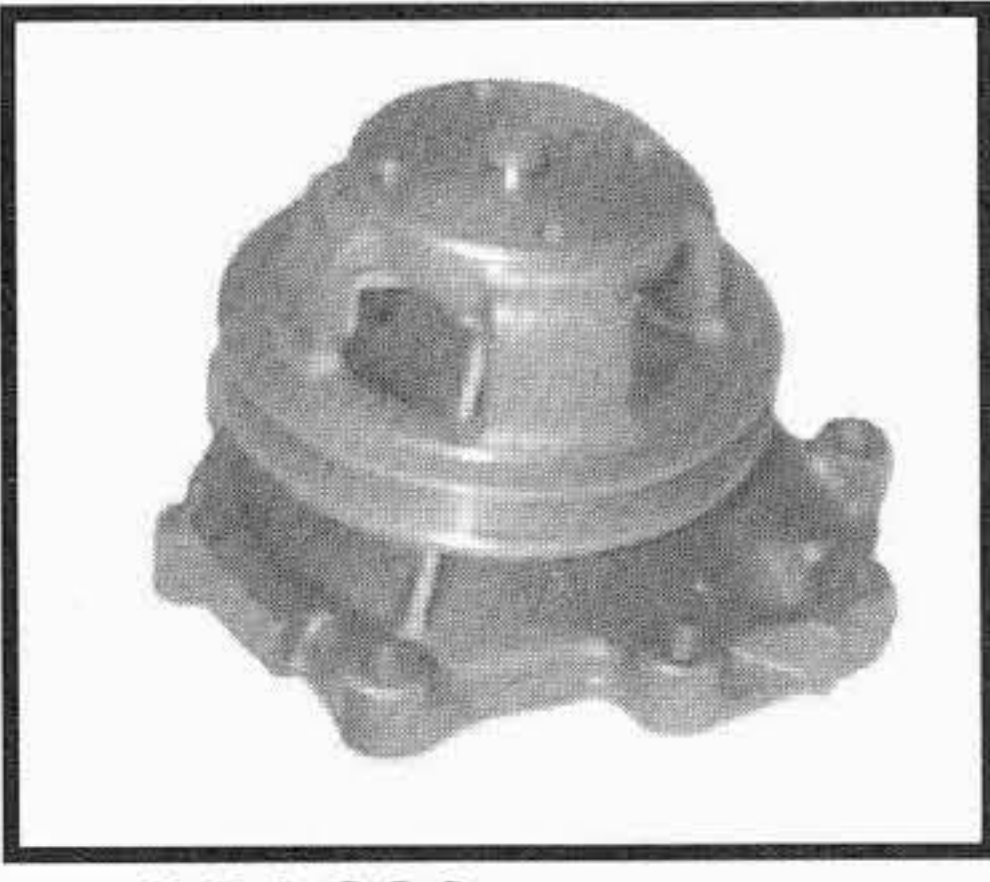
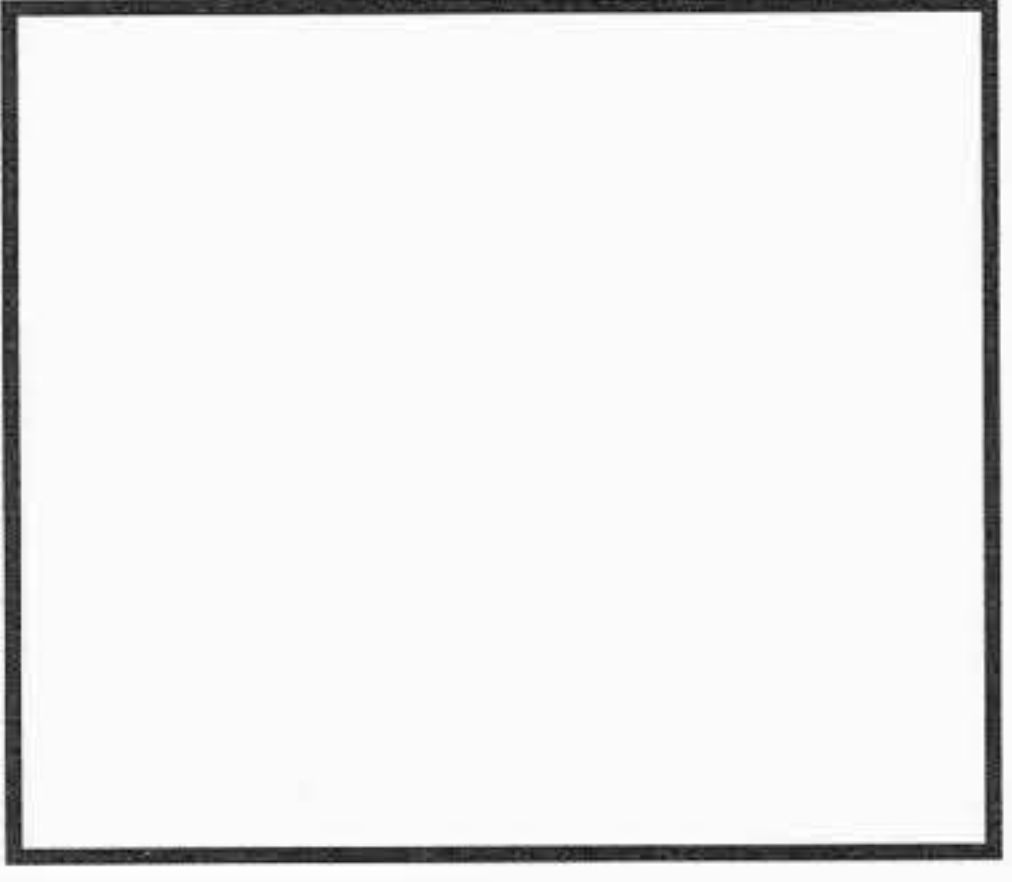
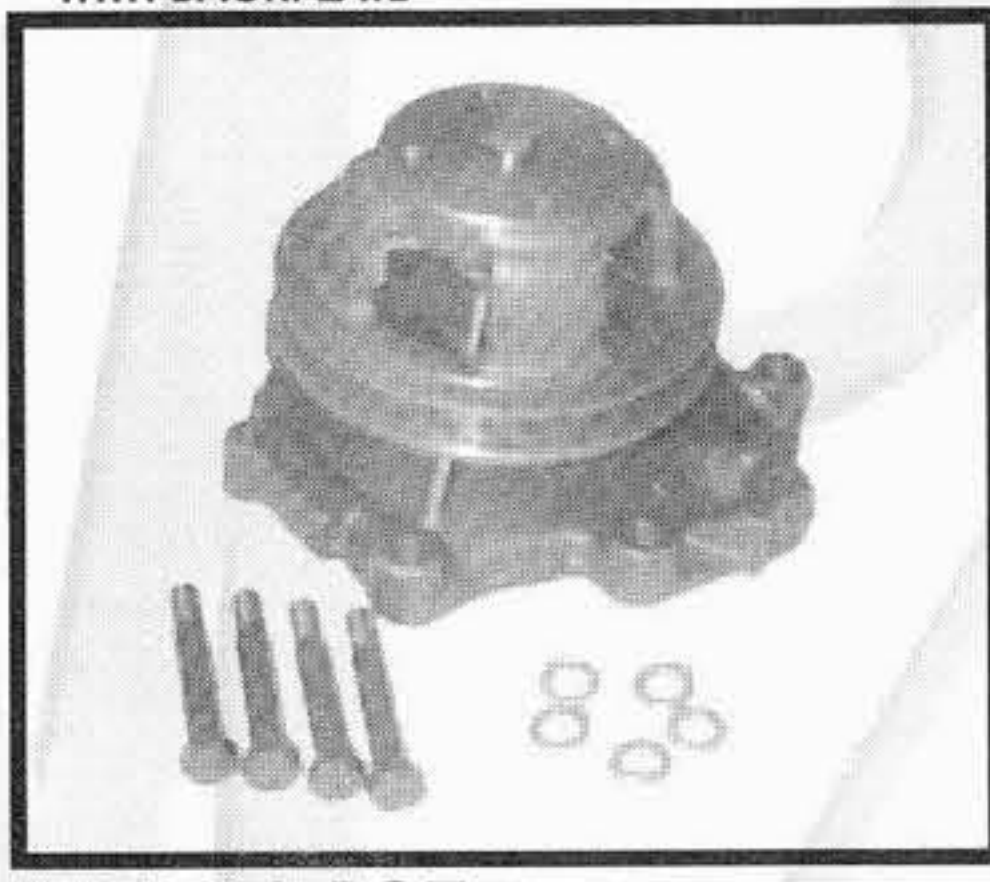
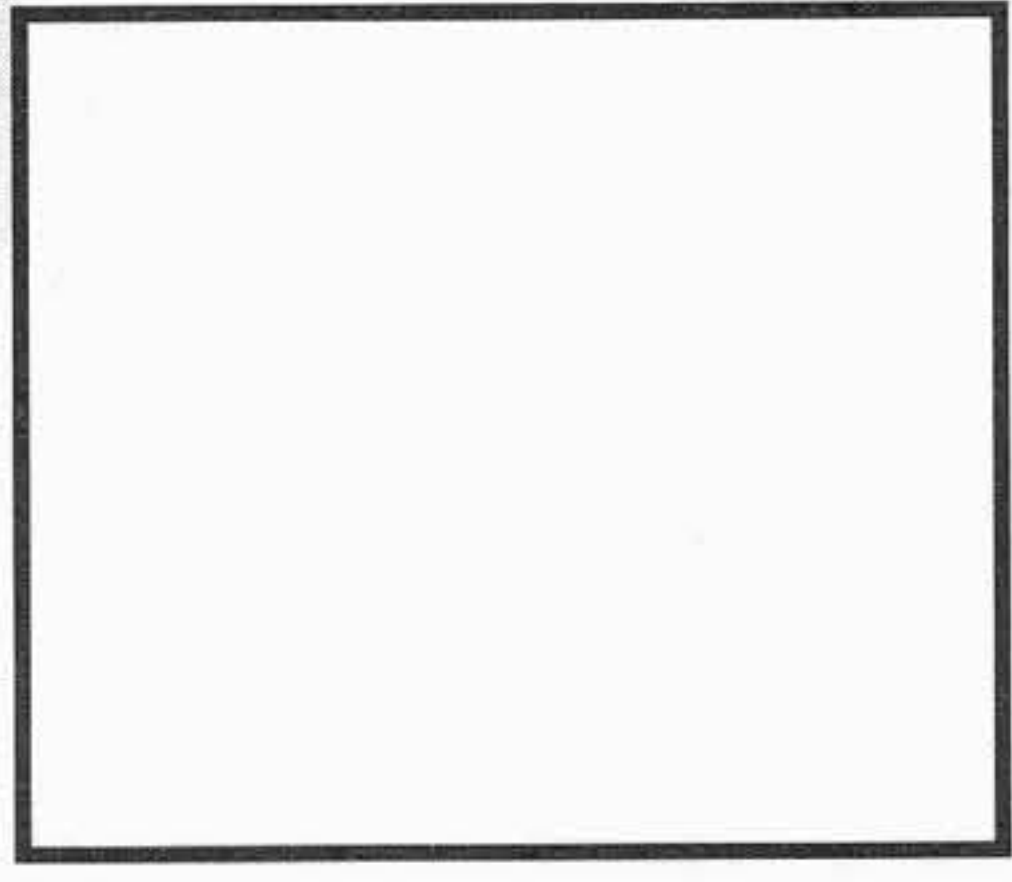
**www.spwaterpumps.co.uk**

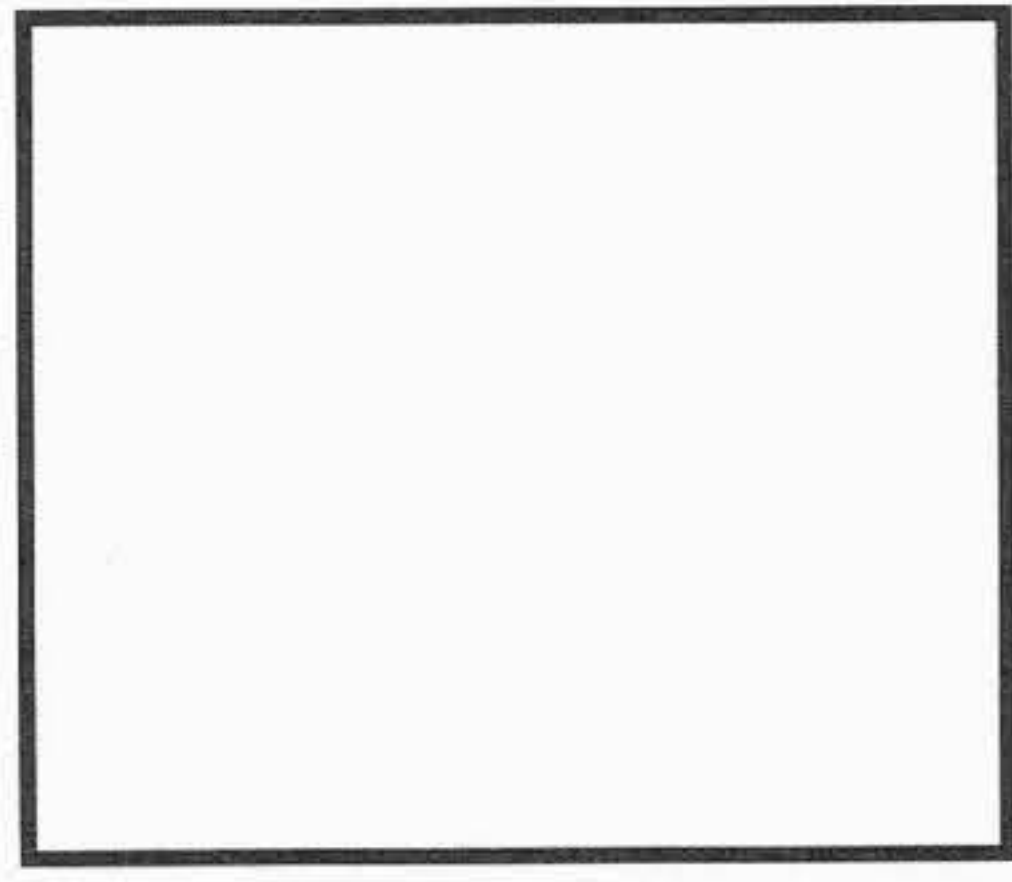

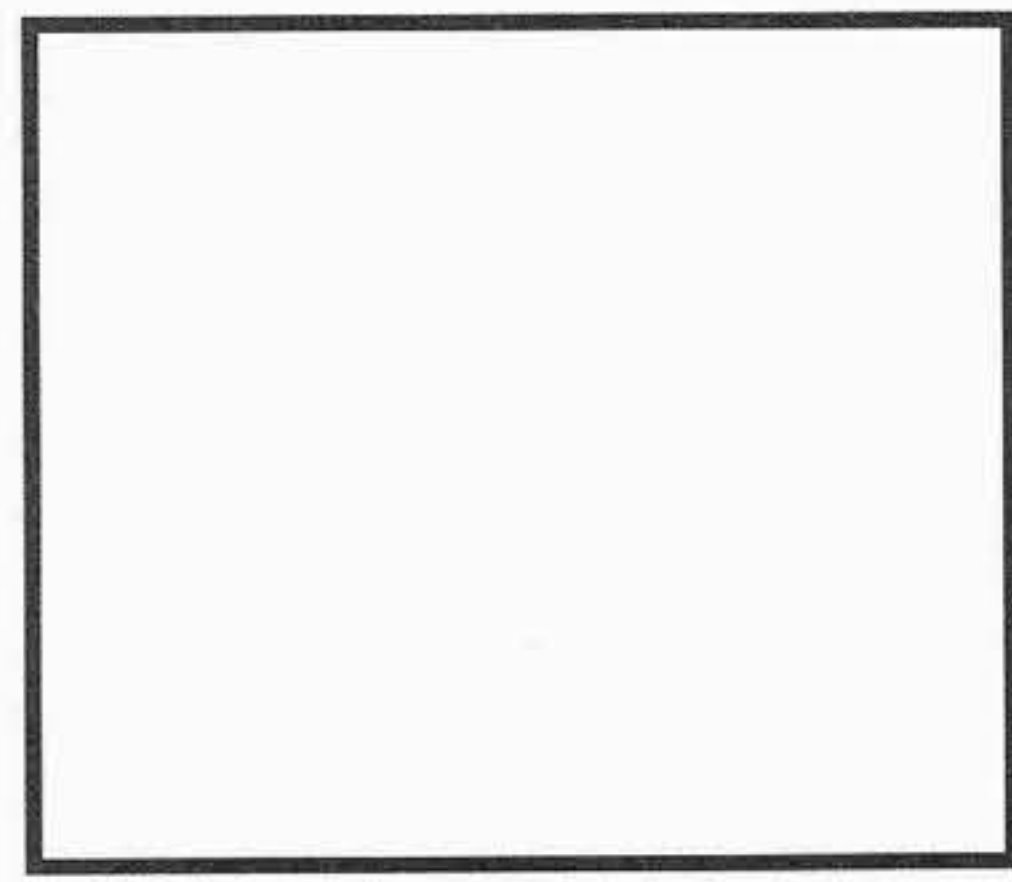
TIPO O MODELLO TYPE OU MODELE TYPE OR MODEL	MOTORE MOTEUR ENGINE	POMPA ACQUA POMPE A EAU WATER PUMP	KIT RIPARAZIONE NECESSAIRE DE REP. REPAIR KIT
<p>2000 - 2100 - 2110 - 2120 - 2150 - 2300 2310 - 3000 - 3055 - 3100 - 3120 - 3150 3190 - 3300 - 3310 - 3400 - 3500 - 3550 4000 - 4100 - 4110 - 4140 - 4190 - 4200 4400 - 4410 - 4500 - 5000 - 5100 - 5190 5200 - 7000 - 7110 - 7200</p> <p>2600 - 3600 - 3900 - 4100 - 4600 - 5600 5700 - 6600 - 6700 - 7600 - 7700</p> <p>230 A - 230 B - 231 - 233 333 - 335 - 420</p> <p>442 - 515 - 530 A - 530 B - 532 - 535</p> <p>2310 - 2610 - 2810 - 2910 - 3610 - 3910 4110 - 4610 - 5610 - 5900 - 6610 - 6710 7610 - 7710</p>	<p>Ford 3 - 4 cyl. ----&gt; <b>1971</b></p> <p>Ford 3 - 4 cyl. ----&gt; <b>1981</b></p> <p>Ford 4 cyl. ----&gt; <b>1986</b></p> <p>Ford 4 cyl.----&gt; <b>1986</b></p> <p>Ford 3 - 4 cyl. <b>1981</b> ----&gt; <b>1986</b></p>	<p><b>164.087</b> D8NN8501UC CON BASAMENTO / WITH BACKPLATE</p>  <p><b>164.088</b> EAPN8A513F 3926002 SENZA BASAMENTO / WITHOUT BACKPLATE</p>	<p><b>162.149</b> EAPN8591C 3926011</p>  <p>girante / impeller Ø 104 mm premistoppa monoblocco / monbloc seal</p>
<p>230 A - 230 B - 231 233 - 333 - 335 - 420</p> <p>442 - 515 - 530 A 530 B - 532 - 535</p> <p>2310 - 2610 - 2810 - 2910 - 3610 3910 - 4110 - 4610 - 5610 - 5900 6610 - 6710 - 7610 - 7710</p> <p>3230 - 3430 - 3930</p> <p>4130 - 4630 - 5030</p>	<p>Ford 4 cyl. <b>1987</b> ----&gt;</p> <p>Ford 4 cyl. <b>1987</b> ----&gt;</p> <p>Ford 3 - 4 cyl. <b>1987</b> ---&gt;</p> <p><b>3 / 90</b> ---&gt;</p>	<p><b>164.106</b> E6NN8501DC CON BASAMENTO / WITH BACKPLATE <b>81872277</b></p>  <p><b>164.107</b> E6NN8A513DC 81863898 SENZA BASAMENTO / WITHOUT BACKPLATE</p>	<p><b>162.150</b> EGP8591DA 83956729</p> 
<p>A 62</p> <p>230 A - 230 B - 231 <b>with air conditioning</b> ----&gt; <b>1986</b> 233 - 333 - 335 - 420</p> <p>444 T - 515 - 530 A <b>with air conditioning</b> ----&gt; <b>1986</b> 530 A - 532 - 535</p> <p>550 - 555 - 655 - 755</p> <p>2400 - 3600 - 3900 4100 - 4600 - 5600 <b>with air conditioning</b> --&gt; <b>81</b> 5700 - 6600 - 6700 7600 - 7700</p> <p>2310 - 2610 - 2810 - 2910 3610 - 3910 - 4110 - 4610 <b>with air conditioning</b> <b>81</b> --&gt; <b>86</b> 5110 - 5610 - 5900 - 6610 6710 - 7610 - 7710</p>	<p>Ford 4 cyl.</p> <p>Ford 4 cyl.</p> <p>Ford 4 cyl.</p> <p>Ford 4 cyl.</p> <p>Ford 4 cyl.</p>	<p><b>164.091</b> D8NN8501TC CON BASAMENTO / WITH BACKPLATE</p>  <p><b>164.092</b> EAPN8A513E 3926001 SENZA BASAMENTO / WITHOUT BACKPLATE</p>	<p><b>162.200</b> EAPN8591D 83956725</p> 
<p>230 A - 230 B - 231 <b>with air conditioning</b> <b>1987</b> ---&gt; 233 - 333 - 335 - 420</p> <p>444 T - 515 - 530 A <b>with air conditioning</b> <b>1987</b> ---&gt; 530 A - 532 - 535</p> <p>2310 - 2610 - 2810 - 2910 - 3610 3910 - 4110 - 4610 - 5610 - 5900 <b>with air conditioning</b> <b>1987</b> ---&gt; 6610 - 6710 - 7610 - 7710</p> <p><b>Serie M</b></p> <p>M100 - M115 - M135 - M160</p>	<p>Ford 4 cyl.</p> <p>Ford 4 cyl.</p> <p>7450 4 cyl. - 5000 cc</p> <p>7675 - 7675T 6 cyl. - 7500 cc</p>	<p><b>164.113</b> E6NN8501CA CON BASAMENTO / WITH BACKPLATE <b>81876233</b></p>  <p><b>164.114</b> EGP8A513CA 81863837 SENZA BASAMENTO / WITHOUT BACKPLATE</p>	<p><b>162.151</b> EGP8591CA 81863952</p> 

I ricambi non sono originali ma adattabili . Ogni riferimento originale é assolutamente indicativo .  
Spare parts are not original but perfectly suitable . Every original part number has to be considered for reference purpose only .



SUITABLE

# NEW HOLLAND FORD

Tel: +44(0)1925 850082 Fax: +(0)44 1925 850083

www.spwaterpumps.co.uk

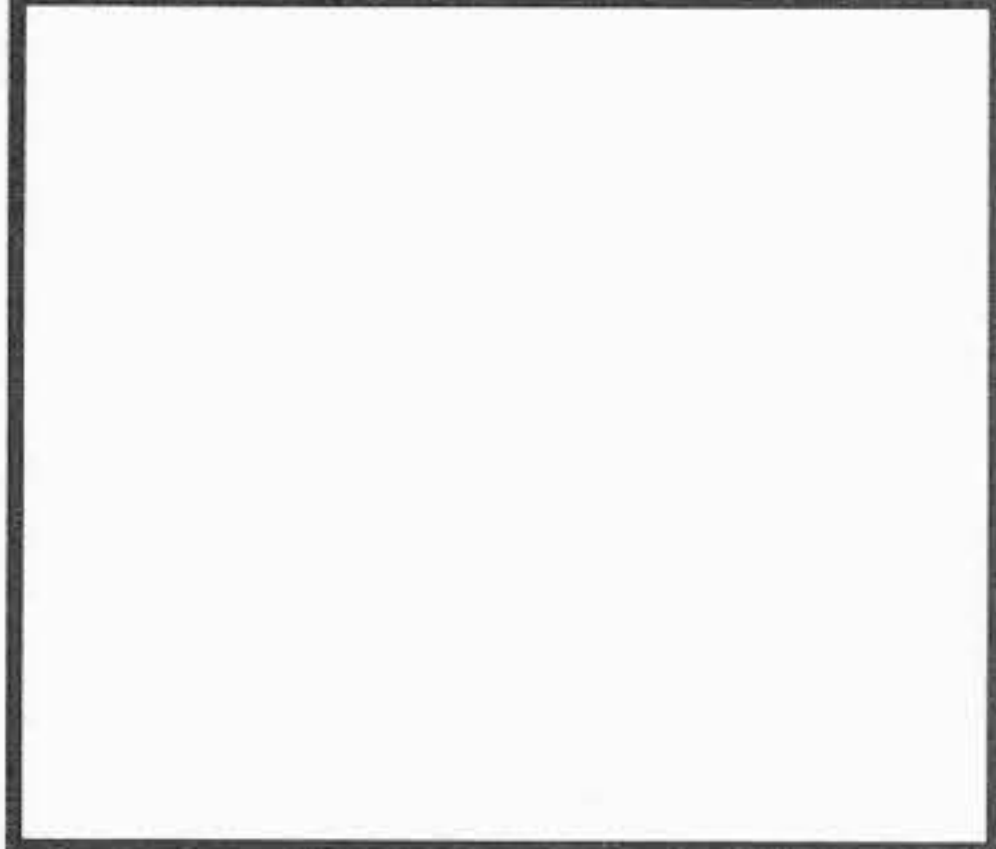
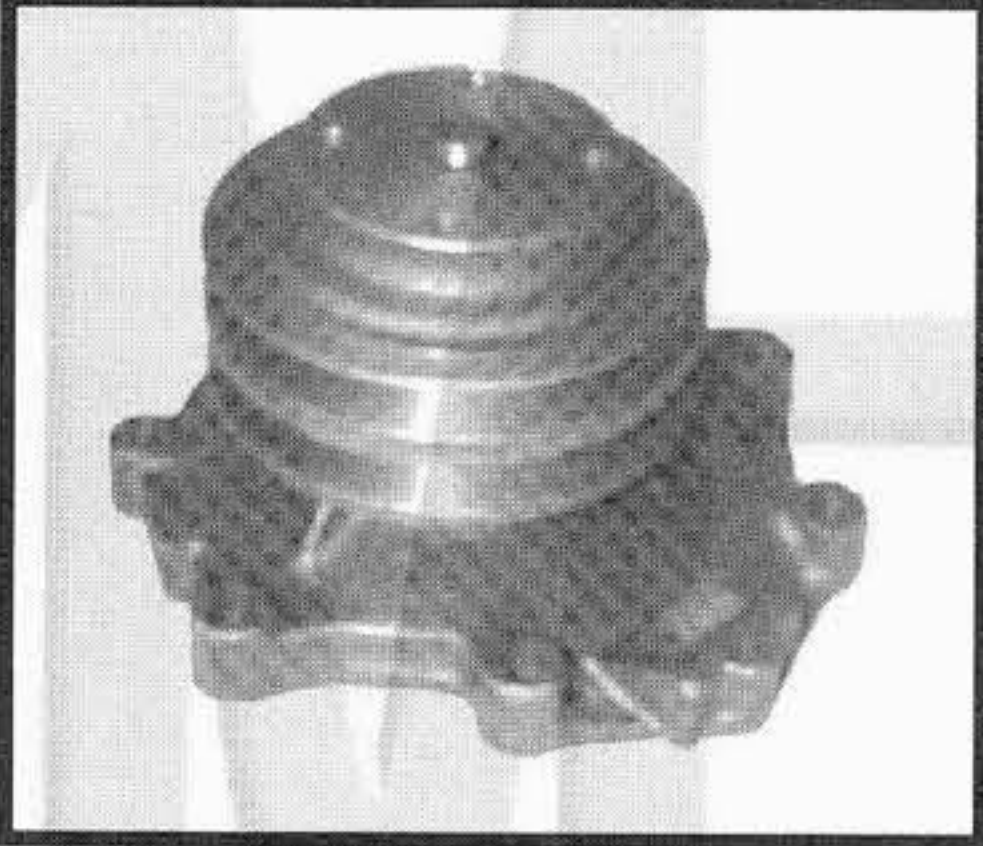
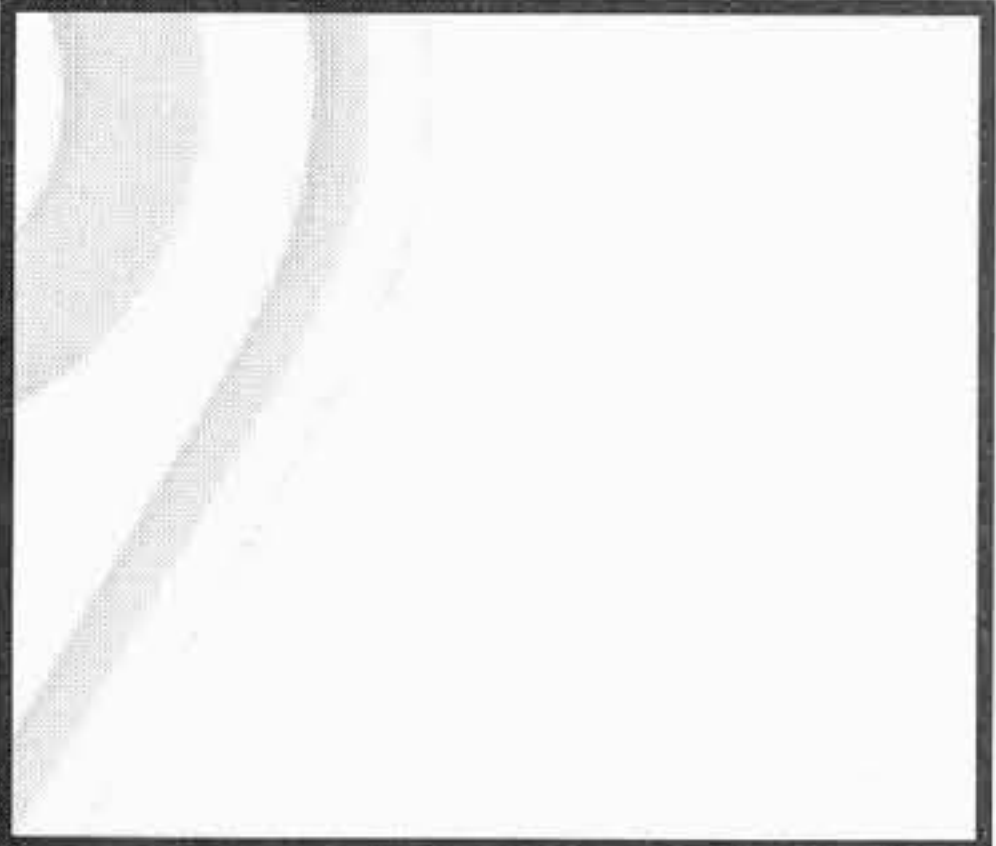
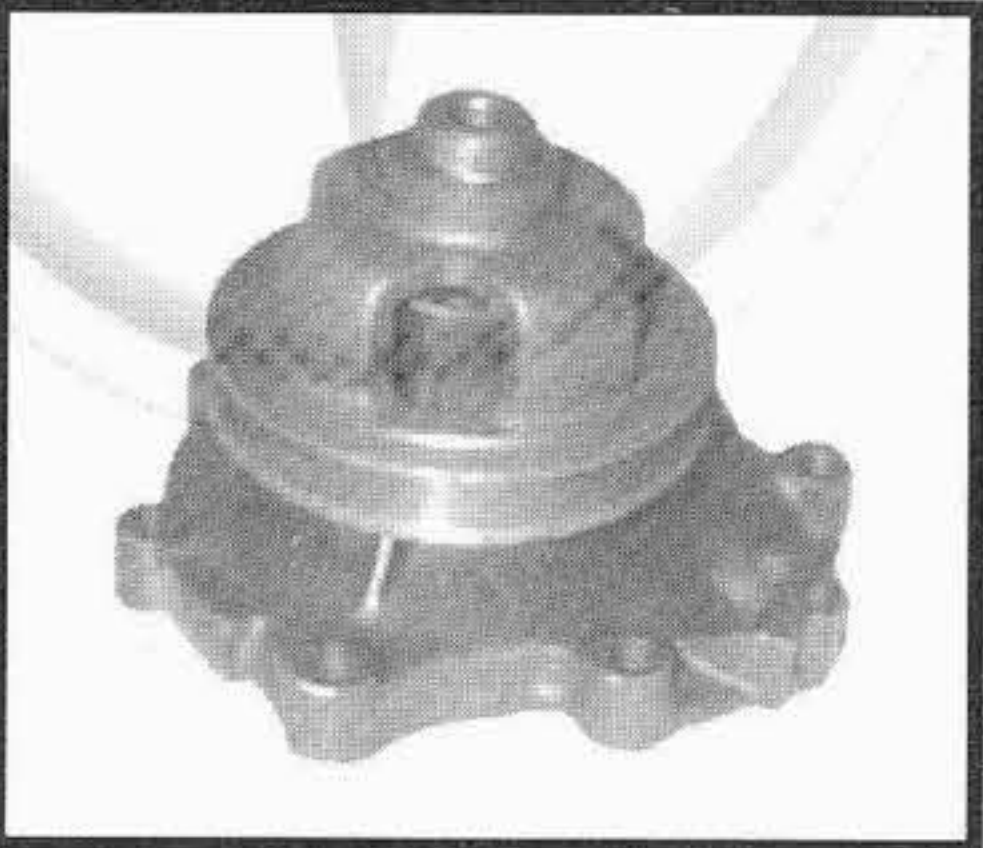
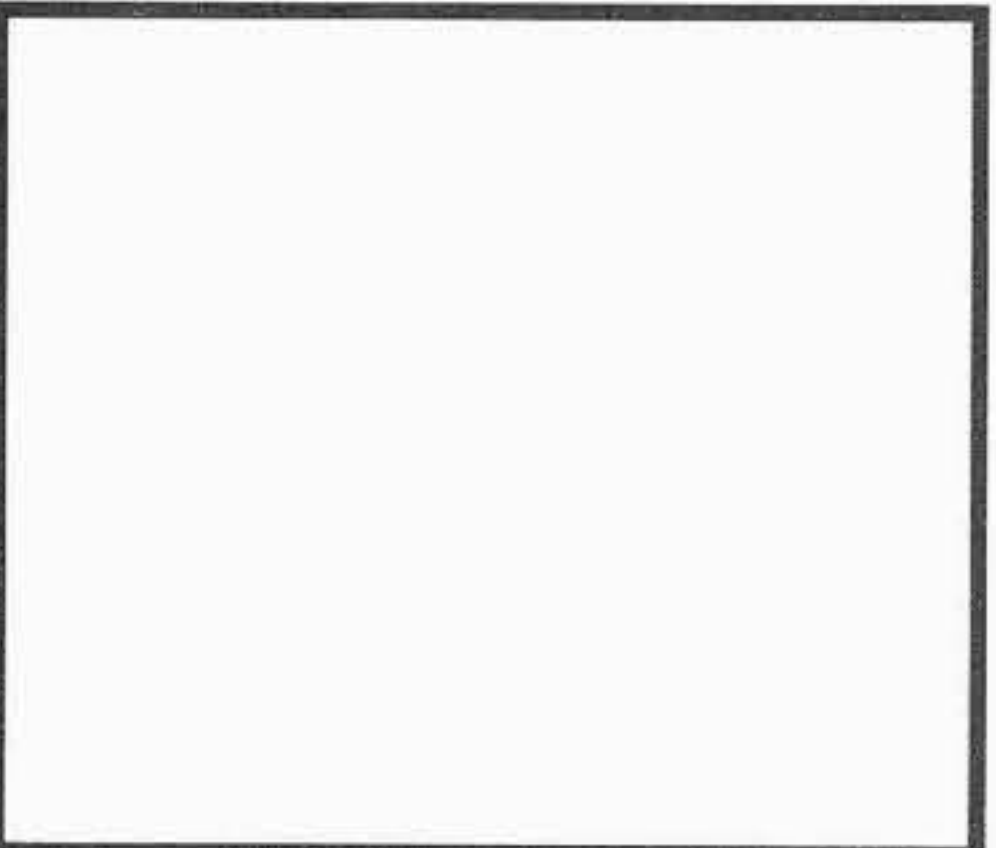

TIPO O MODELLO TYPE OU MODELE TYPE OR MODEL	MOTORE MOTEUR ENGINE	POMPA ACQUA POMPE A EAU WATER PUMP	KIT RIPARAZIONE NECESSAIRE DE REP. REPAIR KIT
<p>A 64 - A 66 -----&gt; 1986</p> <p>7910 - 8210 - 8530</p> <p>8630 - 8730 - 8830</p> <p>8700 - 9700</p> <p>TW 5 - TW 10 - TW 15 - TW 20 -----&gt; 1986</p> <p>TW 25 - TW 30 - TW 35</p>	<p>Ford 666 - 6 cyl.</p> <p>Ford 666 - 6 cyl.</p> <p>Ford 666 - 6 cyl.</p> <p>Ford 666 - 6 cyl.</p>	<p>--- D8NN8501MC CON BASAMENTO / WITH BACKPLATE 81872282</p>  <p>164.093 EAPN8A513G 81863921</p> <p>SENZA BASAMENTO / WITHOUT BACKPLATE</p>	<p>162.207 EAPN8591E 83961311</p>  <p>girante / impeller Ø 119 mm premistoppa monoblocco / monbloc seal</p>
<p>A 64 - A 66 1987 -----&gt;</p> <p>TW 5 - TW 10 - TW 15 - TW 20 1987 -----&gt;</p> <p>TW 25 - TW 30 - TW 35</p> <p>7810 ----&gt; 02 / 82 - 10 / 91</p>	<p>Ford 666 - 6 cyl.</p> <p>Ford 666 - 6 cyl.</p>	<p>--- E6NN8501AA CON BASAMENTO / WITH BACKPLATE 81872290</p>  <p>164.185 EJPN8A513BA 81863835</p> <p>SENZA BASAMENTO / WITHOUT BACKPLATE</p>	<p>162.152 EJPN8591DA 81863991</p>  <p>girante / impeller Ø 119 mm premistoppa monoblocco / monbloc seal</p>
<p>5110 - 5610 ----&gt; 11 / 88 - 10 / 91</p> <p>6610 - 7610 - 7710</p> <p>6410 ----&gt; 02 / 82 - 10 / 91</p> <p>6810</p> <p><b>SENZA aria condizionata WITHOUT air conditioning</b></p> <p><b>CON ventilatore viscostatico WITH viscostatic fan</b></p>	<p>Ford 4 cyl.</p>	<p>164.175 E7NN8501EB CON BASAMENTO / WITH BACKPLATE 81872287</p>  <p>164.180 EJPN8A513EB 81863909</p> <p>SENZA BASAMENTO / WITHOUT BACKPLATE</p>	<p>162.153 EJPN8591EB 81863983</p>  <p>girante / impeller Ø 96 mm premistoppa monoblocco / monbloc seal Ø 38,1 mm</p>
<p>5110 - 5610 ----&gt; 11 / 88 - 10 / 91</p> <p>6610 - 7610 - 7710</p> <p>6410 ----&gt; 02 / 82 - 10 / 91</p> <p>6810</p> <p><b>CON aria condizionata WITH air conditioning</b></p> <p><b>CON ventilatore viscostatico WITH viscostatic fan</b></p>	<p>Ford 4 cyl.</p>	<p>164.096 E7NN8501FE CON BASAMENTO / WITH BACKPLATE 81872289</p>  <p>164.097 E7NN8A513CE 81863830</p> <p>SENZA BASAMENTO / WITHOUT BACKPLATE</p>	<p>162.154 EJPN8591FB 81864001</p>  <p>girante / impeller Ø 96 mm premistoppa monoblocco / monbloc seal Ø 38,1 mm</p>

I ricambi non sono originali ma adattabili . Ogni riferimento originale é assolutamente indicativo .  
Spare parts are not original but perfectly suitable . Every original part number has to be considered for reference purpose only .



SUITABLE

# NEW HOLLAND FORD

Tel:+44(0)1925 850082 Fax: +(0)44 1925 850083

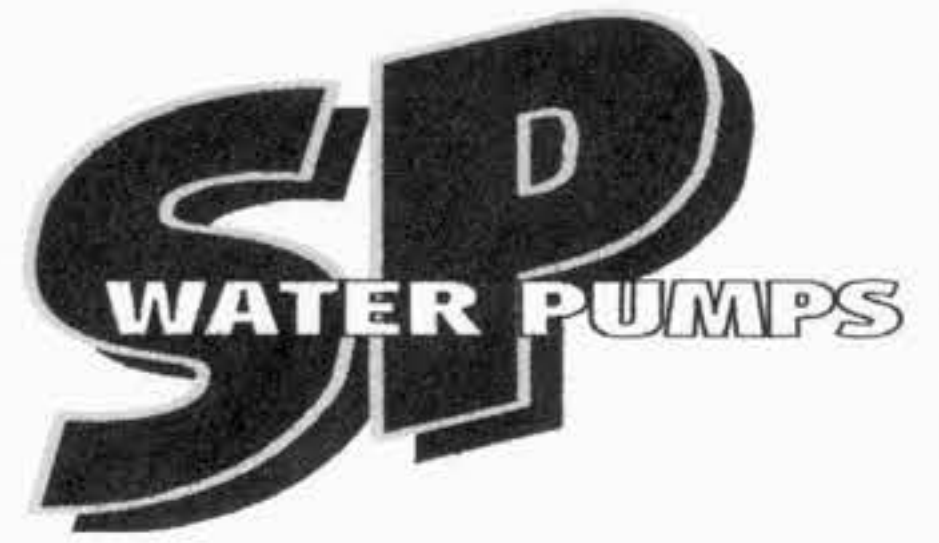
www.spwaterpumps.co.uk

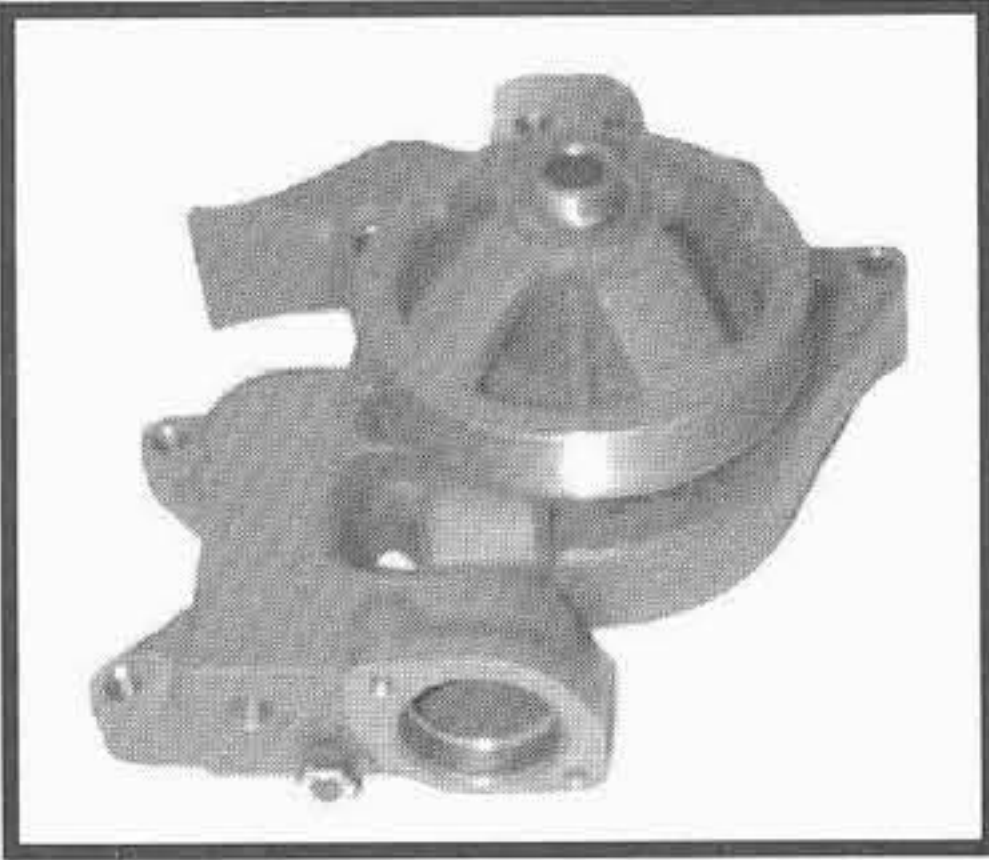
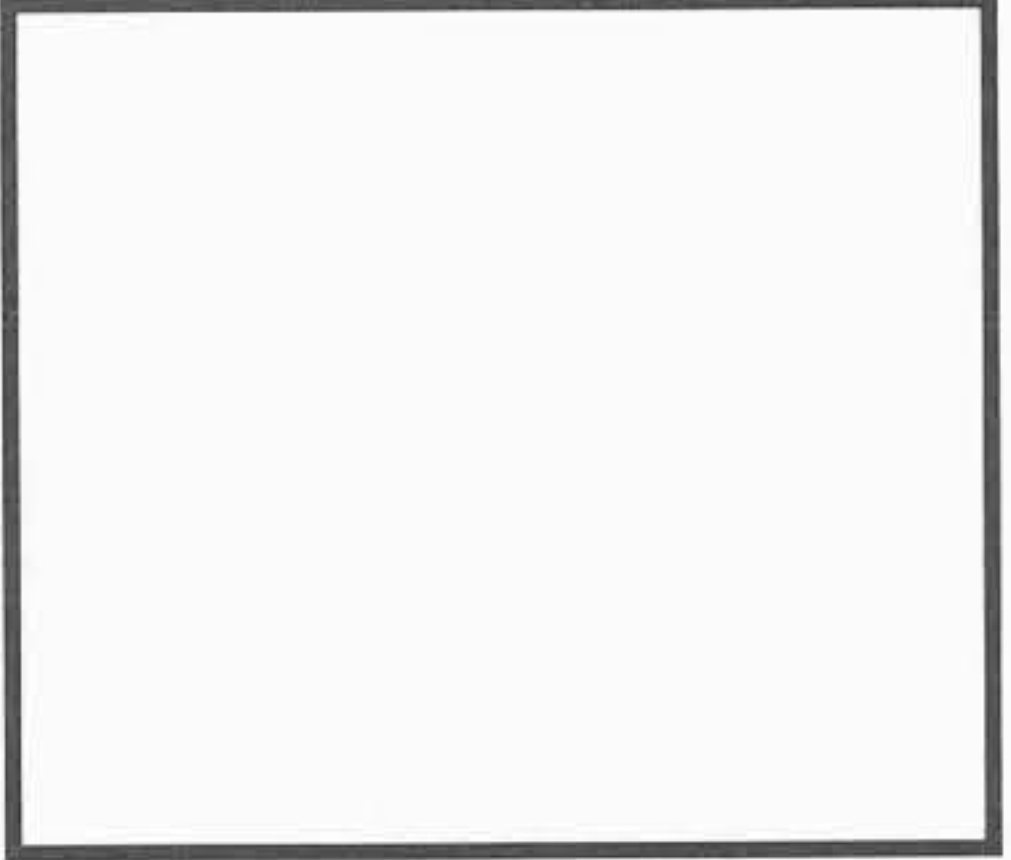
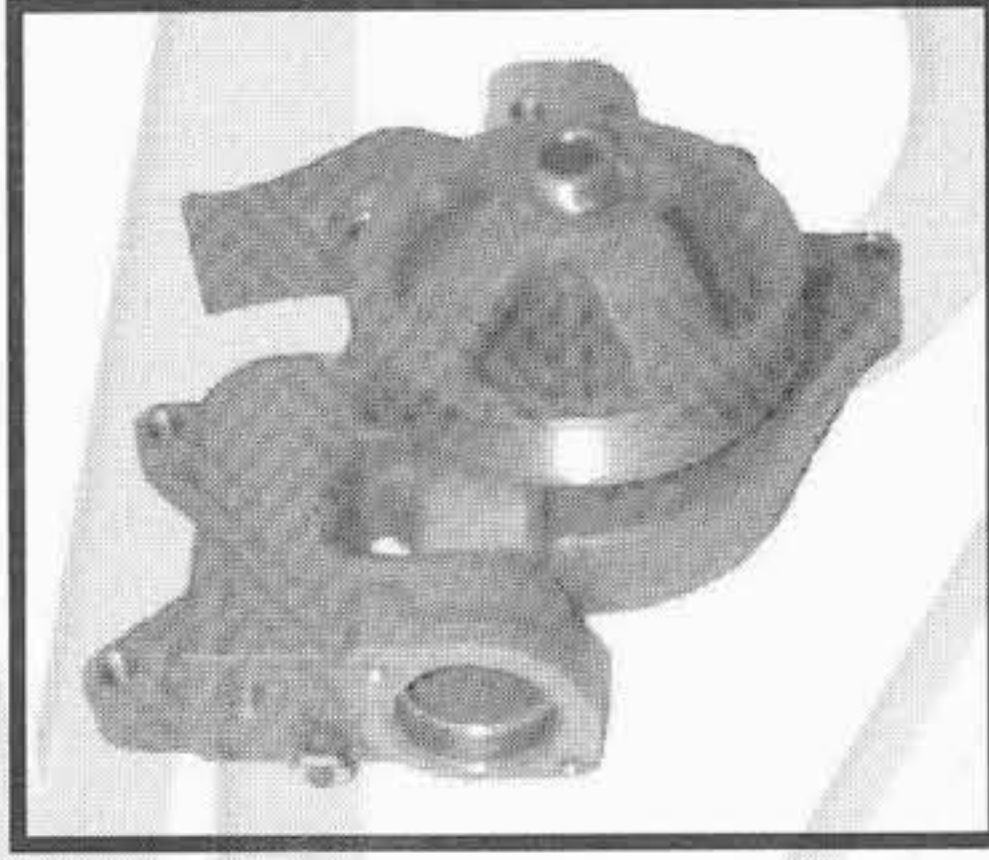
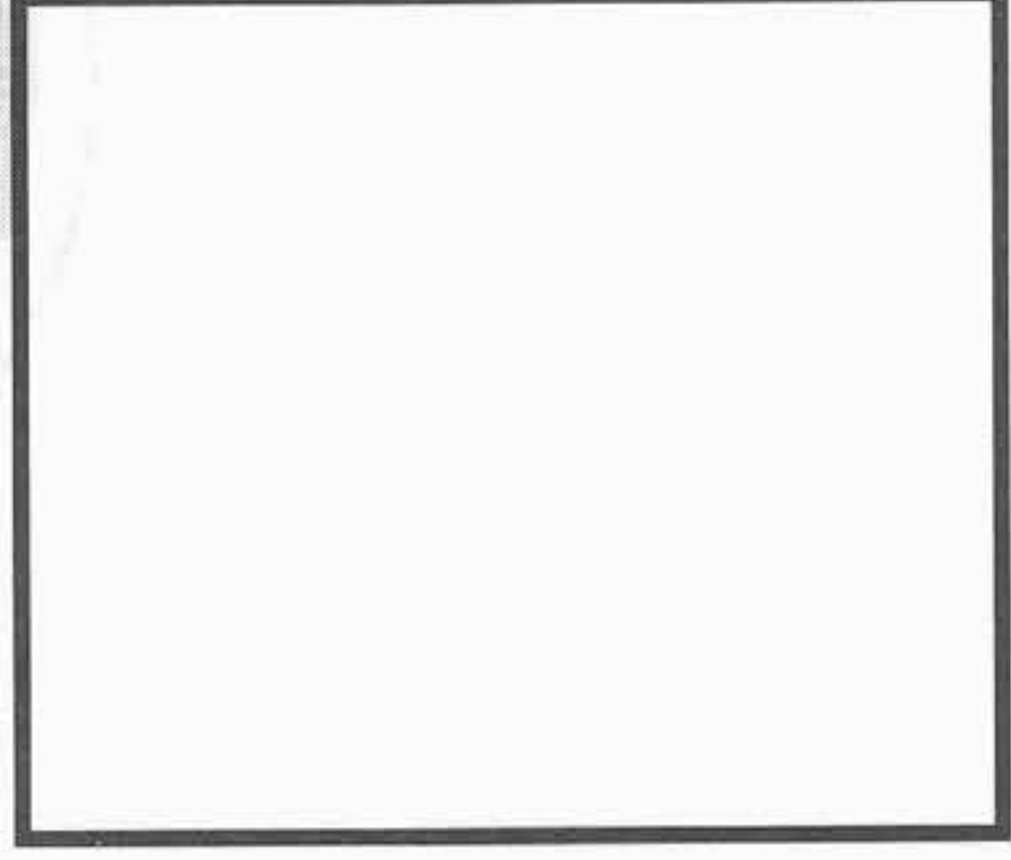
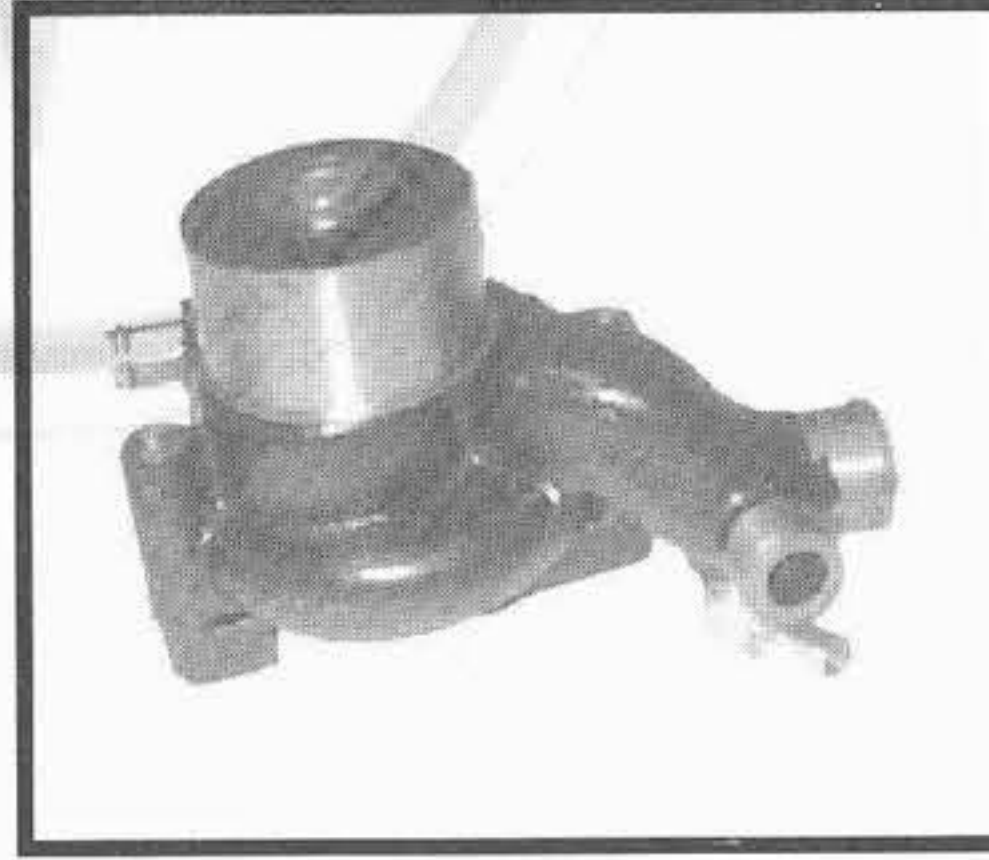
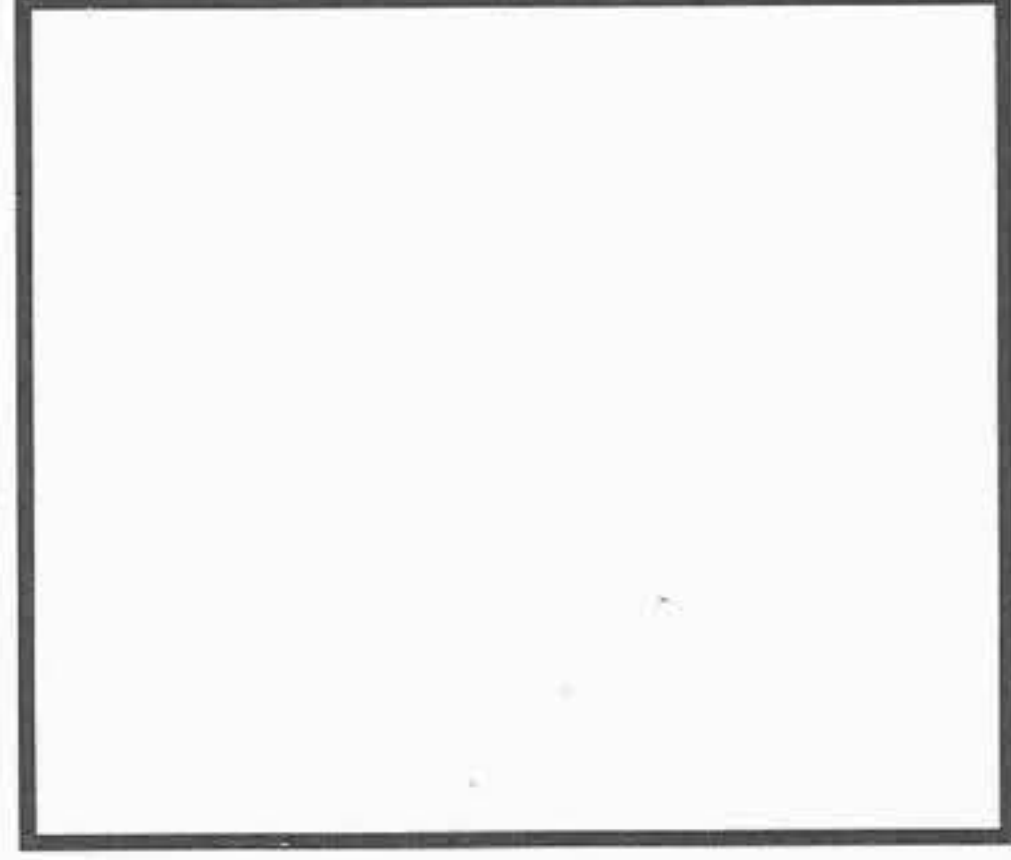

TIPO O MODELLO TYPE OU MODELE TYPE OR MODEL	MOTORE MOTEUR ENGINE	POMPA ACQUA POMPE A EAU WATER PUMP OMP REF. / O.EM. REF	KIT RIPARAZIONE NECESSAIRE DE REP. REPAIR KIT OMP REF. / O.EM. REF
5640 11 / 91 ----> 6640  6410 ----> 02 / 82 - 10 / 91 6810  <b>Serie TS</b> TS 90 - TS100 - TS110	Genesis 4 cyl. 5000 cc	<p><b>164.170</b> FONN8501DC 81869617</p> 	<p><b>162.156</b> FBPN8591A 81866488</p> 
7740 8240 11 / 91 ----> 8340  7840 ----> 02 / 82 - 10 / 91	Genesis 6 cyl. 7500 cc	<p><b>164.165</b> FONN8501CC 81869616</p> 	<p><b>162.157</b> FBPN8591B 81866491</p> 
8870 DT  <b>Serie G</b> G170 - G190 G210 - G240	6 cyl. Turbo 7500 cc	<p>- - 87800490</p> 	<p>- - 87790240</p> 
			

I ricambi non sono originali ma adattabili . Ogni riferimento originale é assolutamente indicativo .  
 Spare parts are not original but perfectly suitable . Every original part number has to be considered for reference purpose only .



**SECTION 34/2**

**APPLICATION**

**PERKINS**

**WATER PUMPS WASSERPUMPEN  
POMPE A EAU BOMBA DE AGUA  
POMPA ACQUA**

**S.P. WATER PUMPS LTD  
18 Tatton Court, Kingsland Grange, Woolston,  
Warrington, Cheshire. ENGLAND. WAI 4RR  
TEL: +44(0) 1925 850082 Fax: +44(0) 1925 850083  
Email:sales@spwaterpumps.co.uk Web Site:www.spwaterpumps.co.uk**

TAVOLE DI CONVERSIONE  
TABLE DE CONVERSION  
CONVERSION TABLE

PERKINS -



NUMERO ORIGINALE NUMERO ORIGINAL ORIGINAL NUMBER	NUMERO SOSTITUTIVO REPLACE PAR NUMERO REPLACED BY NUMBER	RIFERIMENTO OMP REFERENCE OMP OMP REFERENCE
32346		259.066
58293	89019	
59140	89024	
68355	U7LW0008	
68364	U7LW0062	
68573	U7LW0007	
68575	U7LW0015	
68584	U7LW0020	
85707	86948	252.154
85800	U7LW0025	
85805	U7LW0003	
86948	U7LW0055	
86951	U7LW0003	
86957	U7LW0029	
89001	U7LW0022	
89007	U7LW0024	
89009	U7LW0022	
89019	U7LW0044	
89024	U7LW0027	
89030	U7LW0003	
89032		
89034	U7LW0006	
89036	U7LW0009	
0030927		259.058
0040057		259.058
0080268	0170040	251.184
0170046		259.009
0380098		259.053
0380164		259.051
0490484		259.068
0490690		259.064
0500006		251.191
0524406		259.028
0576005		259.006
0576007		259.031
0650540		259.041
0670165		259.305
0748419		259.071
0920007		251.201
0920009		259.032
0920056		259.037
0920058		251.772
0920106		251.381
0994650	3600973M91	
0994658	41312038	
2232133		259.072
2415209	2415216	

NUMERO ORIGINALE NUMERO ORIGINAL ORIGINAL NUMBER	NUMERO SOSTITUTIVO REPLACE PAR NUMERO REPLACED BY NUMBER	RIFERIMENTO OMP REFERENCE OMP OMP REFERENCE
2415213		259.136
2415216		251.042
2417204		259.141
2417208		259.022
2431154		259.041
2564406		259.028
2418M001	2418M004	
2418M004		259.428
2418M006		
2418M007		159.428
2521D406		259.158
2721A530		251.354
31142691		259.335
31145630		259.035
31145713		259.315
31145741		259.085
31146362		259.135
31146952		259.015
31155232		259.205
32753417		259.056
32764119	3276P003	
32764124		259.078
32764127	3276P003	
3276P003		259.014
3312K011		259.156
3312K012		251.204
33143112		259.024
33143409		259.077
33157108		259.019
33157109		259.017
33157144		259.037
33415136		259.039
33811314		259.052
33813313		259.018
33814115		259.038
36866271		259.042
36866724	36866271	
36867108		259.101
36867137		259.087
37447192		259.061
37447603		259.076
37447632		259.084
37447680		259.143
37477232		259.059
37711262		259.063
37711301		259.129
37711321		259.089

OGNI RIFERIMENTO ORIGINALE E' ASSOLUTAMENTE INDICATIVO. CHAQUE REFERENCE ORIGINAL EST ABSOLUMENT INDICATIVE. EVERY ORIGINAL PART NUMBER HAS TO BE CONSIDERED FOR REFERENCE PURPOSE ONLY.

TAVOLE DI CONVERSIONE  
TABLE DE CONVERSION  
CONVERSION TABLE

PERKINS -



NUMERO ORIGINALE NUMERO ORIGINAL ORIGINAL NUMBER	NUMERO SOSTITUTIVO REPLACE PAR NUMERO REPLACED BY NUMBER	RIFERIMENTO OMP REFERENCE OMP OMP REFERENCE
37711530		259.067
37711632		259.016
37711892		259.381
37712330		259.201
37712390		
37712470		259.291
37712540	37712541	
37712541		259.221
37712630		259.134
3771F011		159.391
41312038	41312063	
41312054	41312055	
41312055	41312494	
41312059	41312159	
41312063	41312064	
41312064	41312067	
41312067	41312165	
41312143	41312201	
41312159	41312416	
41312165	41312167	
41312167	41312266	
41312201	41312219	
41312219	41312245	
41312245	41312246	
41312246	41312248	
41312248	41312251	
41312251	41312323	
41312266	41312506	
41312323	41312325	
41312325	41312348	
41312348	41312349	
41312349	41312351	
41312351	41312354	
41312354	41312356	
41312356	41312358	
41312358	41312366	
41312366	41312379	
41312379	41312551	
41312416	41312487	
41312419	VEDI U5MW0014	
41312459		259.370
41312486	VEDI U5MW0057	
41312487		259.080
41312491	VEDI U5MW0057	
41312493	VEDI U5MW0057	
41312494	41312517	
41312506	41312508	

NUMERO ORIGINALE NUMERO ORIGINAL ORIGINAL NUMBER	NUMERO SOSTITUTIVO REPLACE PAR NUMERO REPLACED BY NUMBER	RIFERIMENTO OMP REFERENCE OMP OMP REFERENCE
41312508	41312509	
41312511	41312574	
41312517	41312544	
41312518		259.110
41312521		259.070
41312524	VEDI U5MW0057	
41312527	VEDI U5MW0057	259.310
41312544	41312784	
41312549	41312557	
41312551	41312552	
41312552	41312554	
41312554	41312561	
41312557	41312558	
41312558	41312559	
41312559	41312654	
41312561	41312562	
41312562	41312564	
41312564	41312566	
41312566	41312568	
41312568	41312689	
41312574	= 41312892	259.040
41312584	VEDI U5MW0057	
41312589	VEDI U5MW0023	
41312591	VEDI U5MW0023	
41312595	VEDI U5MW0023	
41312596	VEDI U5MW0057	
41312654	41312682	
41312663	VEDI U5MW0014	
41312681	VEDI U5MW0016	
41312682	41312698	
41312689	41312756	
41312698	41312906	
41312723	VEDI U5MW0014	
41312747	VEDI U5MW0014	
41312756	41312908	
41312768	VEDI U5MW0023	
41312783	VEDI U5MW0023	
41312784		259.050
41312785	VEDI U5MW0023	
41312786	VEDI U5MW0023	
41312806	VEDI U5MW0016	
41312807	VEDI U5MW0016	
41312808	VEDI U5MW0016	
41312809	VEDI U5MW0016	
41312811	VEDI U5MW0037	
41312828	VEDI U5MW0014	
41312892	= 41312574	

OGNI RIFERIMENTO ORIGINALE E' ASSOLUTAMENTE INDICATIVO. CHAQUE REFERENCE ORIGINAL EST ABSOLUMENT INDICATIVE. EVERY ORIGINAL PART NUMBER HAS TO BE CONSIDERED FOR REFERENCE PURPOSE ONLY.



TAVOLE DI CONVERSIONE  
 TABLE DE CONVERSION  
 CONVERSION TABLE

**PERKINS -**



NUMERO ORIGINALE NUMERO ORIGINAL ORIGINAL NUMBER	NUMERO SOSTITUTIVO REPLACE PAR NUMERO REPLACED BY NUMBER	RIFERIMENTO OMP REFERENCE OMP OMP REFERENCE
41312906	41312907	
41312907	41313018	
41312911	41312913	
41312913	41312915	
41312915	41312918	
41312918	41313201	
41313018	41313045	
41313027		159.355
41313033	41313047	
41313038	= 41313086	159.070
41313045		159.090
41313047	= 41313049	159.260
41313058	= 41313027	
41313065	= 41313047	
41313068	= 41313045	
41313075	= U5MW0016	
41313085	= U5MW0019	
41313086	= 41313038	
41313201	41313225	
41313209	41313218	
41313211	41313226	
41313212	41313228	259.380
41313218	41313227	159.150
41313225	41313231	
41313226	41313233	
41313227	41313237	
41313228		159.380
41313231	4131A013	159.450
41313232	4131A021	159.460
41313233		159.350
41313237		159.470
41313256	= 41313226	
41313261	= 41313237	
41313269	= U5MW0014	
41313402	= U5MW0057	
41313403	= U5MW0023	
41313801	41313812	
41313812		
4131A013	4131A021	
4131A021	4131A029	
4131A029	4131A034	
4131A034		159.490
4131E002	4131E005	
4131E005	4131E007	
4131E007	4131E011	
4131E011		159.500
4131E012		159.510

NUMERO ORIGINALE NUMERO ORIGINAL ORIGINAL NUMBER	NUMERO SOSTITUTIVO REPLACE PAR NUMERO REPLACED BY NUMBER	RIFERIMENTO OMP REFERENCE OMP OMP REFERENCE
U5MW0006	U5MW0057	
U5MW0010	U5MW0055	
U5MW0014		159.140
U5MW0016		159.230
U5MW0019		159.110
U5MW0023		159.310
U5MW0037		
U5MW0041	U5MW0054	
U5MW0044		159.360
U5MW0054		159.370
U5MW0055	U5MW0061	
U5MW0056	U5MW0062	
U5MW0057		159.375
U5MW0061		159.365
U5MW0062		159.475
U5MW0088	= U5MW0062	
U5MW0089	= U5MW0061	
U5MW0092	= 4131E011	
U5MW0096	= U5MW0057	
U5MW0097	= U5MW0023	
U5MW0104	= 4131A034	
U5MW0106	= 41313228	
U5MW0108	= 41313237	
U5MW0111	= 41313045	
U5MW0133	= 41313027	
U5MW0144	= 41313027	
U5MW0147	= U5MW0014	
U7 LW0002	U7 LW0030	
U7 LW0003		252.175
U7 LW0006	U7 LW0029	
U7 LW0007	U7 LW0002	
U7 LW0008	U7 LW0031	
U7 LW0009		152.097
U7 LW0015		152.153
U7 LW0020		252.243
U7 LW0022		152.156
U7 LW0024		252.136
U7 LW0025		152.112
U7 LW0027		152.107
U7 LW0029	U7LW0032	
U7 LW0030		152.255
U7L W0031		152.256
U7 LW0032	U7L W0058	
U7 LW0034	U7 LW0071	
U7 LW0044		152.130
U7 LW0047		152.259
U7 LW0055		152.155

OGNI RIFERIMENTO ORIGINALE E' ASSOLUTAMENTE INDICATIVO. CHAQUE REFERENCE ORIGINAL EST ABSOLUMENT INDICATIVE. EVERY ORIGINAL PART NUMBER HAS TO BE CONSIDERED FOR REFERENCE PURPOSE ONLY.



SUITABLE









# PERKINS

## ENGINES

Tel: +44(0)1925 850082 Fax: +(0)44 1925 850083

www.spwaterpumps.co.uk

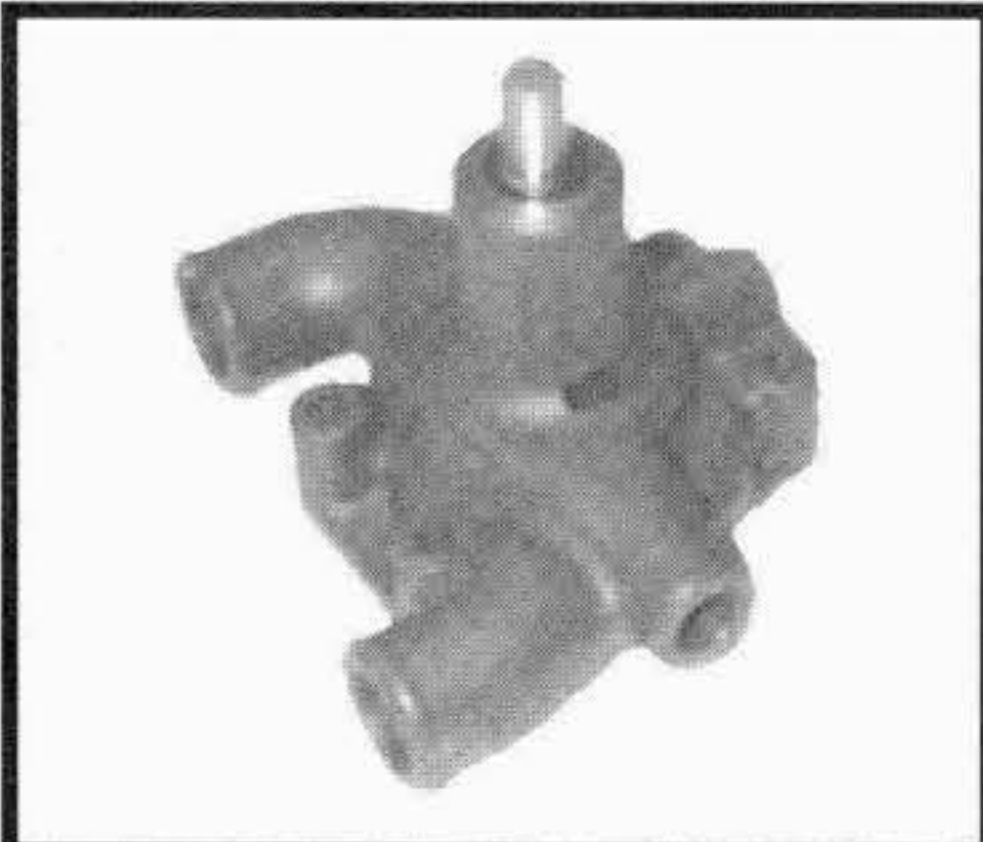

TIPO O MODELLO TYPE OU MODELE TYPE OR MODEL	MOTORE MOTEUR ENGINE	POMPA ACQUA POMPE A EAU WATER PUMP	KIT RIPARAZIONE NECESSAIRE DE REP. REPAIR KIT
	D2.101 P2 P3.144 3.152 AD3.152 D3.152 D3.152M F3.152 T3.152.4	<p><b>159.375</b> U5MW0057 SENZA PULEGGIA / WITHOUT PULLEY</p>  <p>--- 41312493 CON PULEGGIA / WITH PULLEY</p>	<p><b>152.130</b> U7LW0044</p> 
	AP3.144 A3.152 AD3.152 D3.152 T3.152.4	<p><b>259.080</b> 41312487 CON PULEGGIA / WITH PULLEY</p>  <p><b>159.310</b> U5MW0023 SENZA PULEGGIA / WITHOUT PULLEY</p>	<p><b>152.130</b> U7LW0044</p> 
	D3.152 3.152 A3.152 AD3.152	<p><b>259.050</b> 41312784 CON PULEGGIA / WITH PULLEY</p>  <p><b>159.310</b> U5MW0023 SENZA PULEGGIA / WITHOUT PULLEY</p>	<p><b>152.130</b> U7LW0044</p> 
	AP3.144 A3.152 D3.152 AD3.152 T3.152.4	<p><b>159.310</b> U5MW0023 SENZA PULEGGIA / WITHOUT PULLEY</p>  <p>--- 41312536 CON PULEGGIA / WITH PULLEY</p>	<p><b>152.130</b> U7LW0044</p> 

I ricambi non sono originali ma adattabili . Ogni riferimento originale é assolutamente indicativo .  
Spare parts are not original but perfectly suitable . Every original part number has to be considered for reference purpose only .

SUITABLE





# PERKINS

## ENGINES

Tel: +44(0)1925 850082 Fax: +(0)44 1925 850083

www.spwaterpumps.co.uk

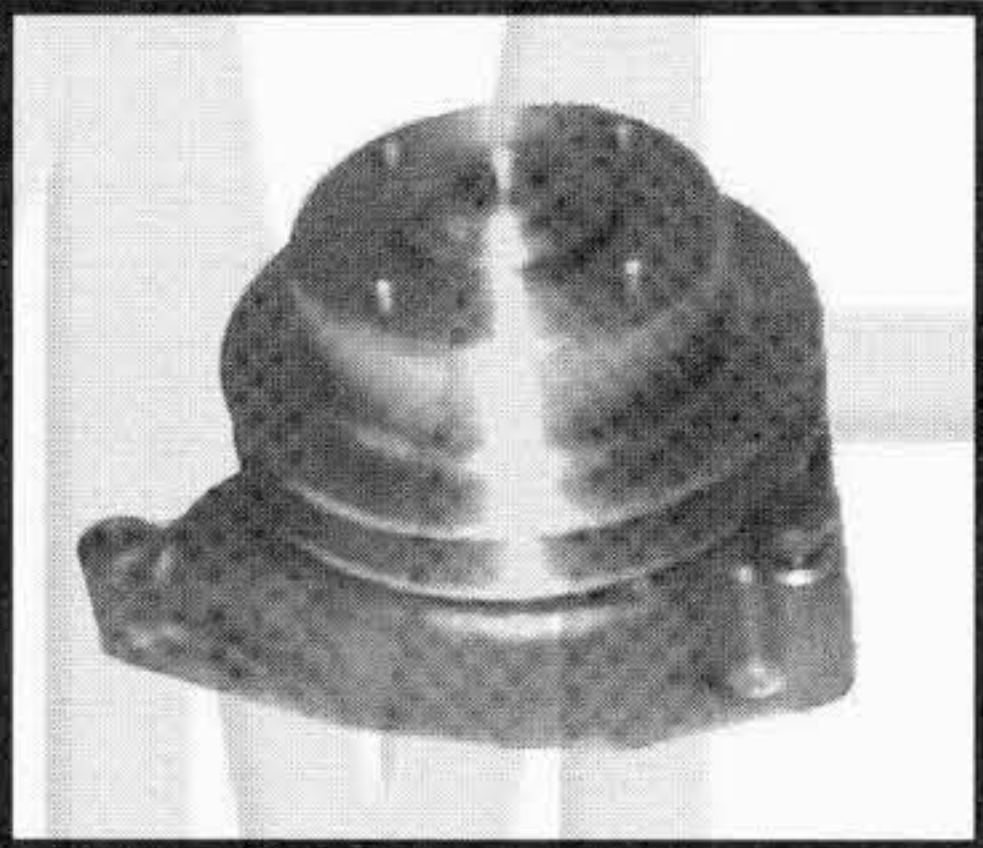
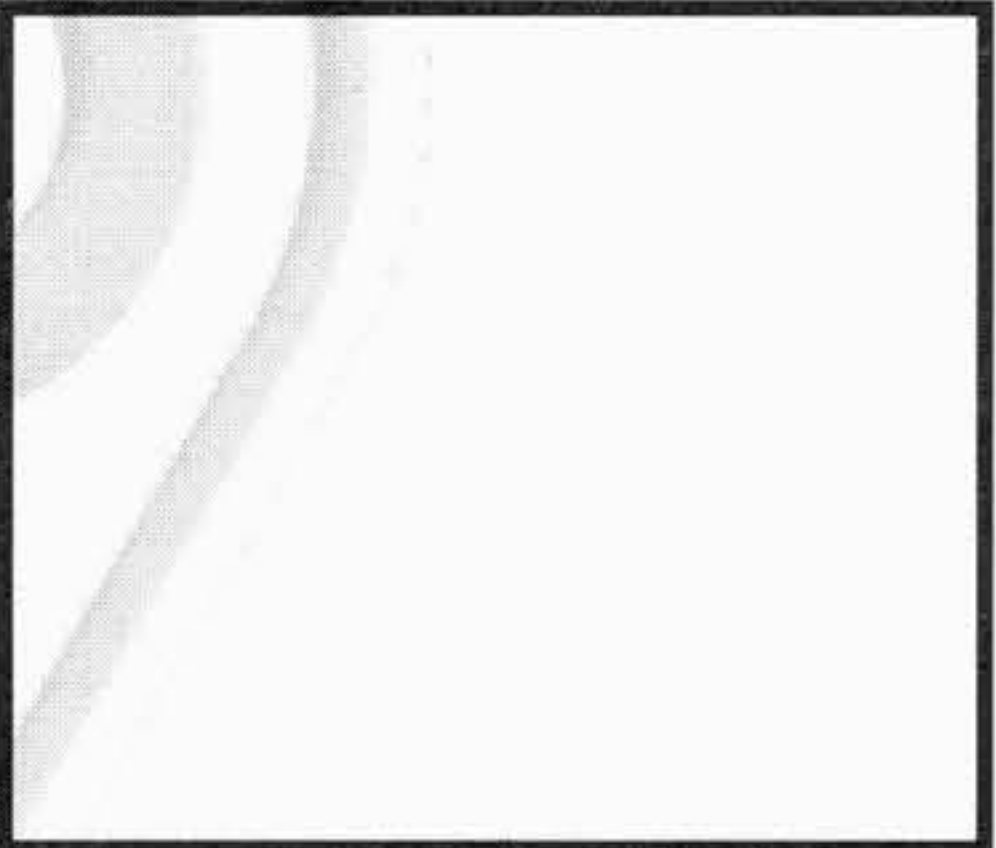
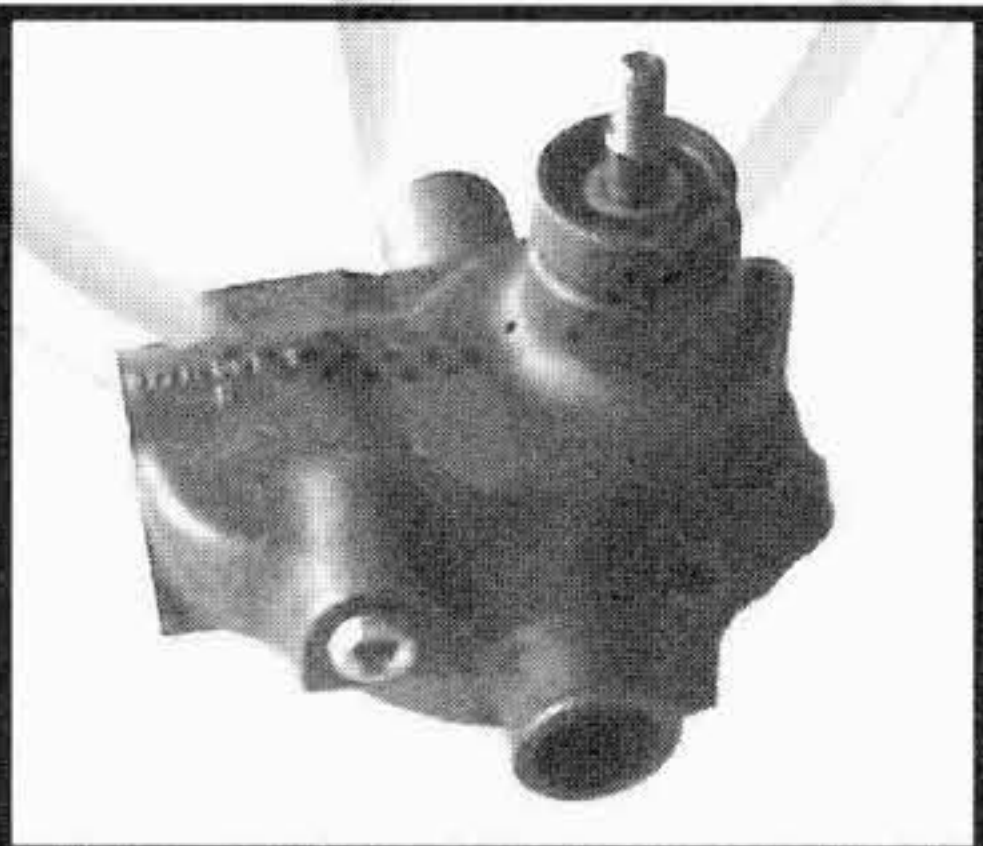

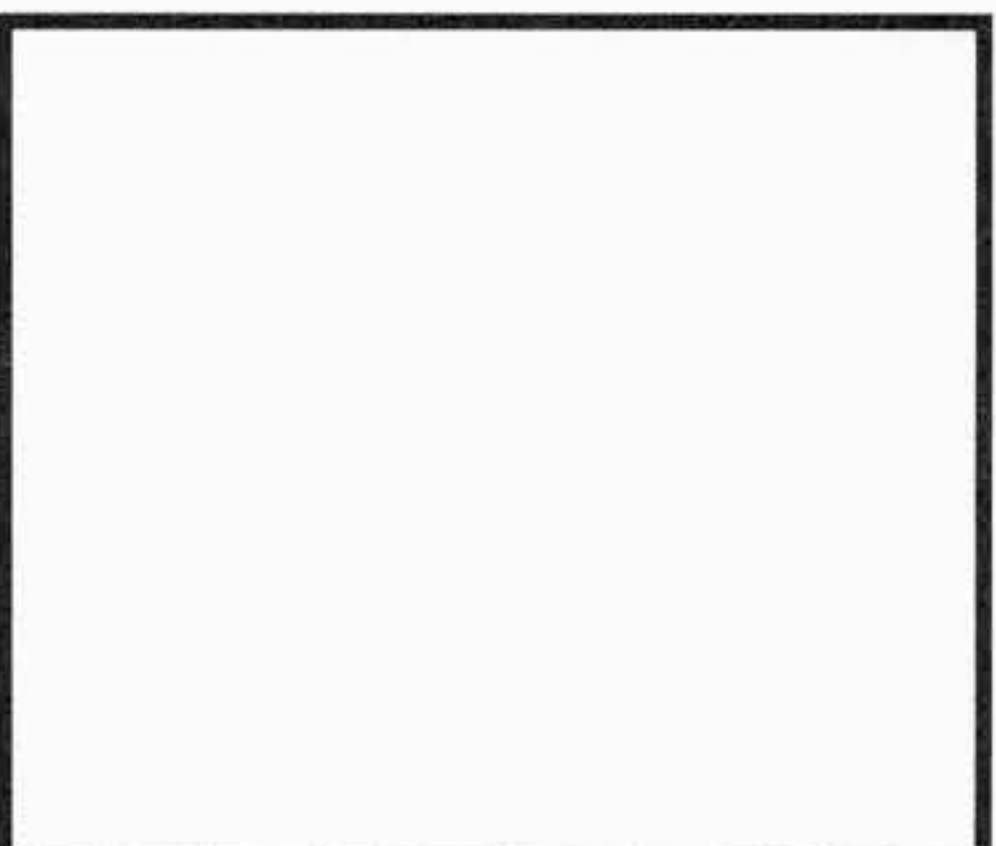
TIPO O MODELLO TYPE OU MODELE TYPE OR MODEL	MOTORE MOTEUR ENGINE	POMPA ACQUA POMPE A EAU WATER PUMP OMP REF. / O.EM. REF	KIT RIPARAZIONE NECESSAIRE DE REP. REPAIR KIT OMP REF. / O.EM. REF
	3.152.2  3.152.4  A3.152  D3.152  AD3.152	<p><b>159.310</b> U5MW0023 SENZA PULEGGIA / WITHOUT PULLEY</p> 	<p><b>152.130</b> U7LW0044</p> 
	4.107  4.108  4.108 M  4.108 O	<p><b>259.370</b> 41312459 CON PULEGGIA / WITH PULLEY</p>  <p><b>159.370</b> U5MW0054 SENZA PULEGGIA / WITHOUT PULLEY</p>	<p><b>252.175</b> U7LW0003</p> 
	4.192  4.203	<p>--- 4131A005 SENZA PULEGGIA / WITHOUT PULLEY</p> 	<p>--- ---</p> 
	A4.192  D4.203  AD4.203	<p><b>259.040</b> 41312574 CON PULEGGIA / WITH PULLEY</p>  <p><b>159.365</b> U5MW0061 SENZA PULEGGIA / WITHOUT PULLEY</p>	<p><b>152.107</b> U7LW0027</p> 

I ricambi non sono originali ma adattabili . Ogni riferimento originale é assolutamente indicativo .  
Spare parts are not original but perfectly suitable . Every original part number has to be considered for reference purpose only .

SUITABLE

# PERKINS

## ENGINES

Tel: +44(0)1925 850082 Fax: +(0)44 1925 850083

www.spwaterpumps.co.uk

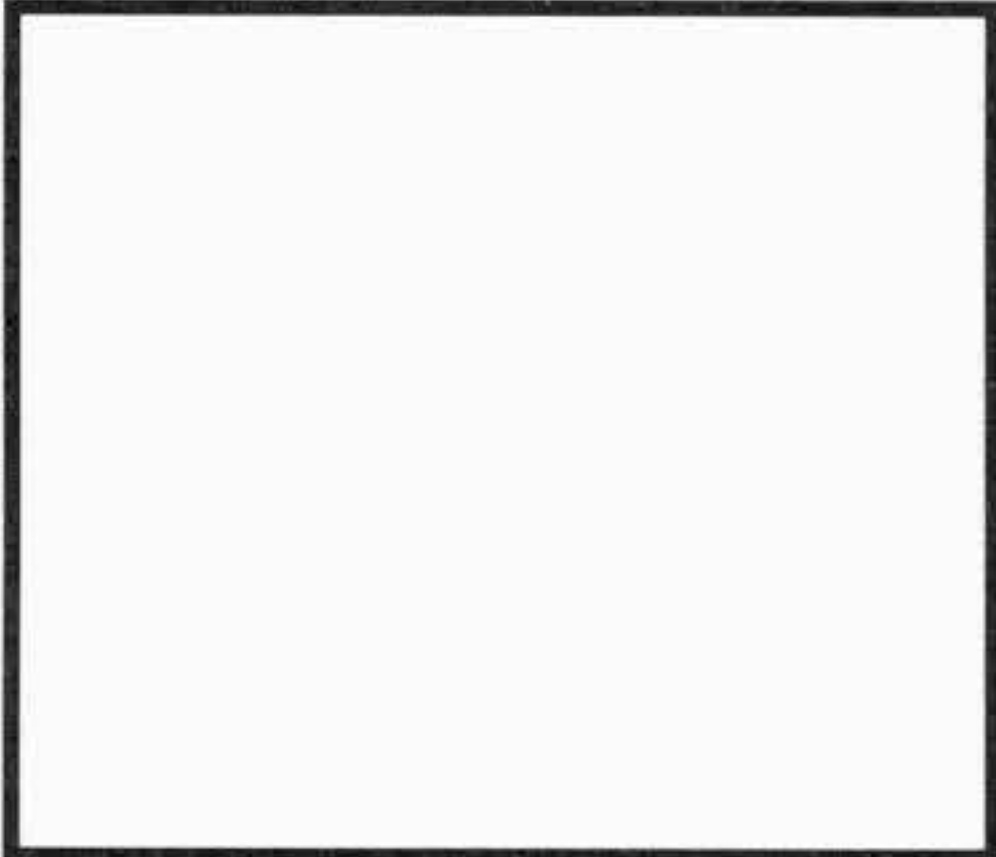
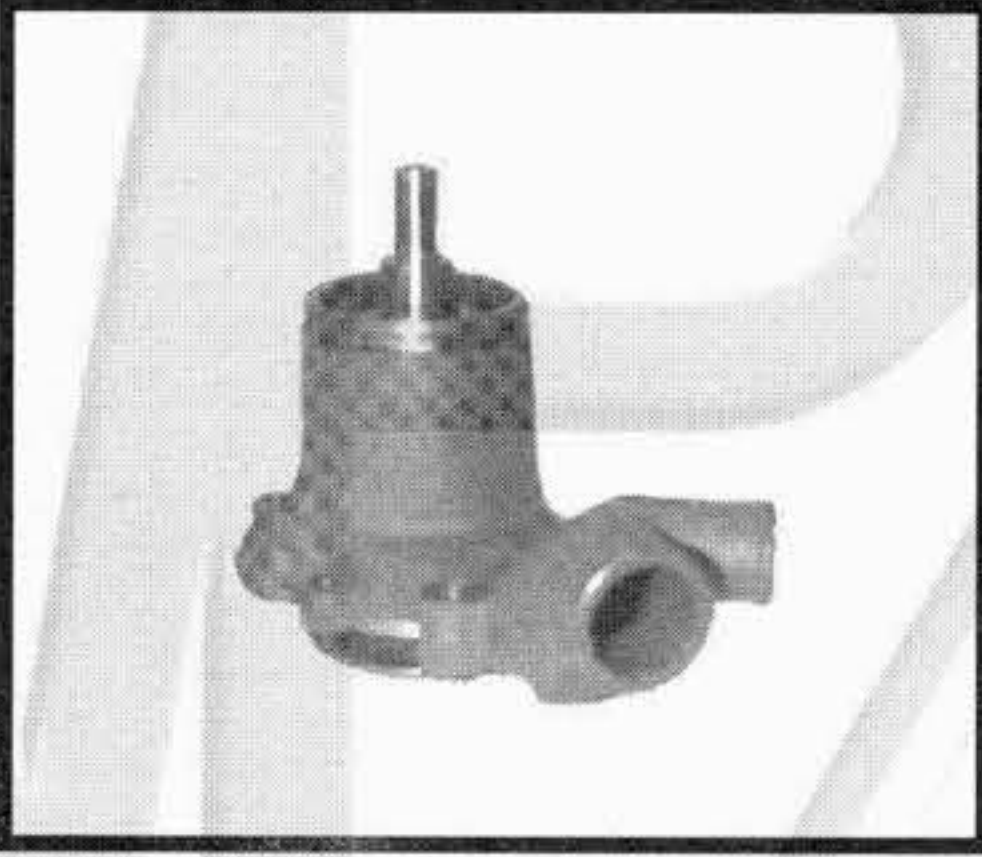
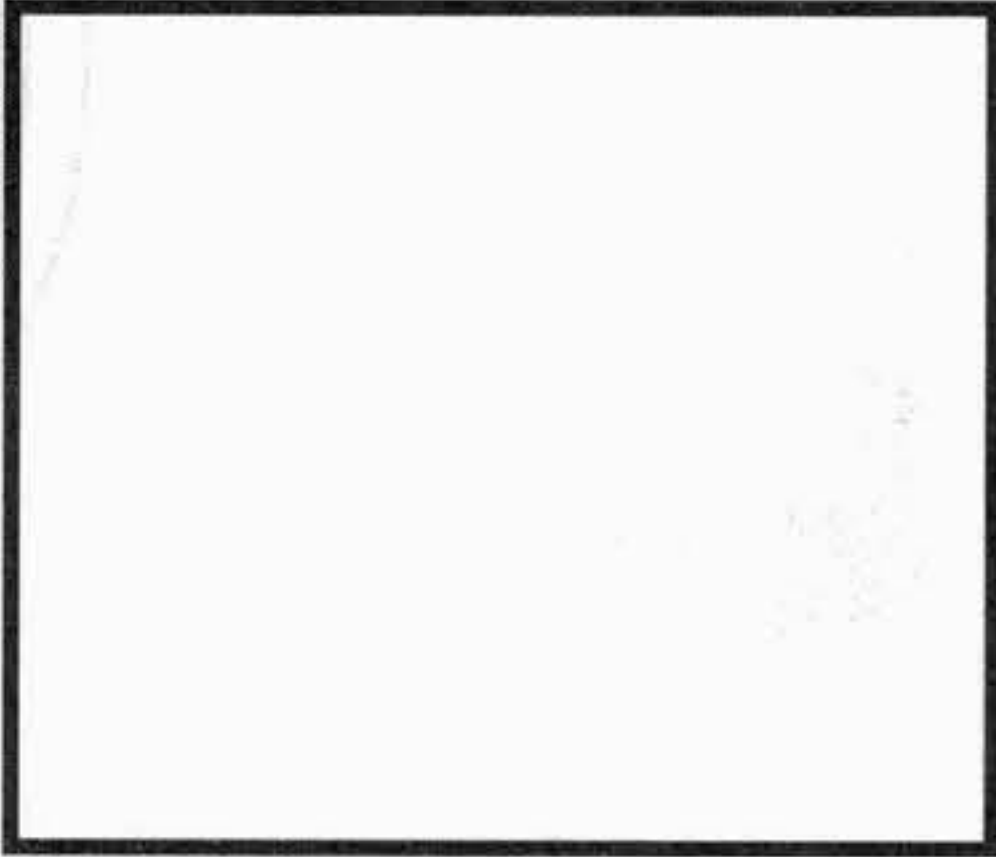
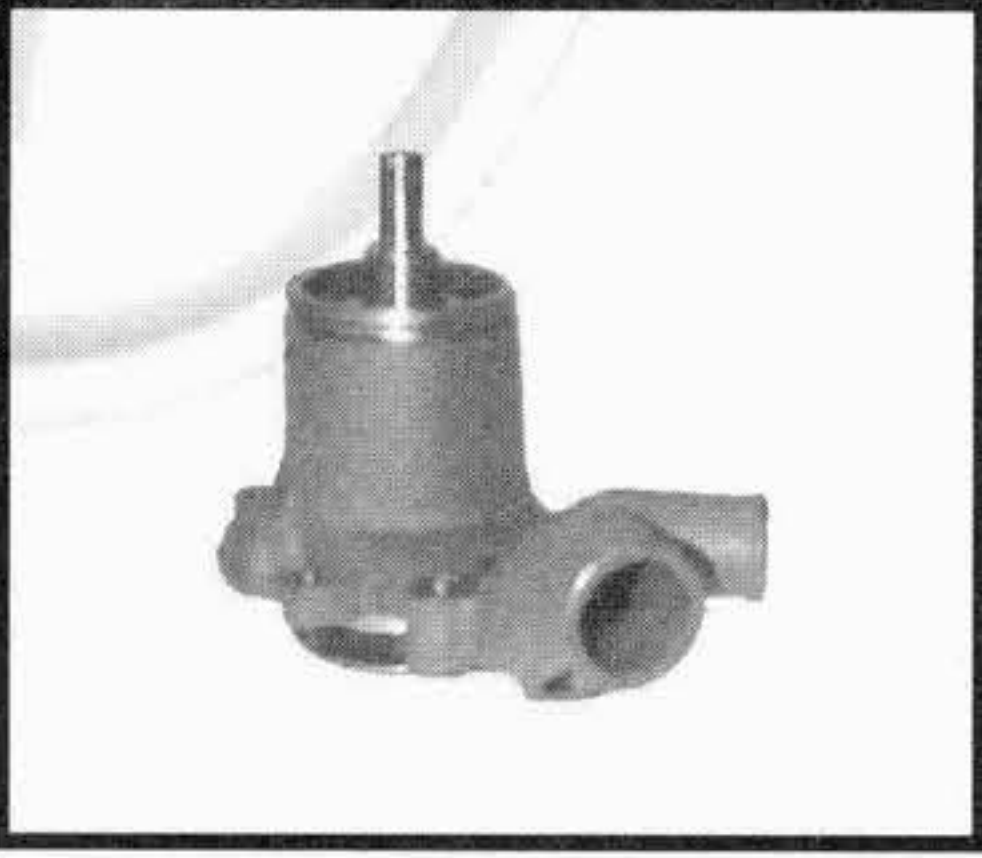
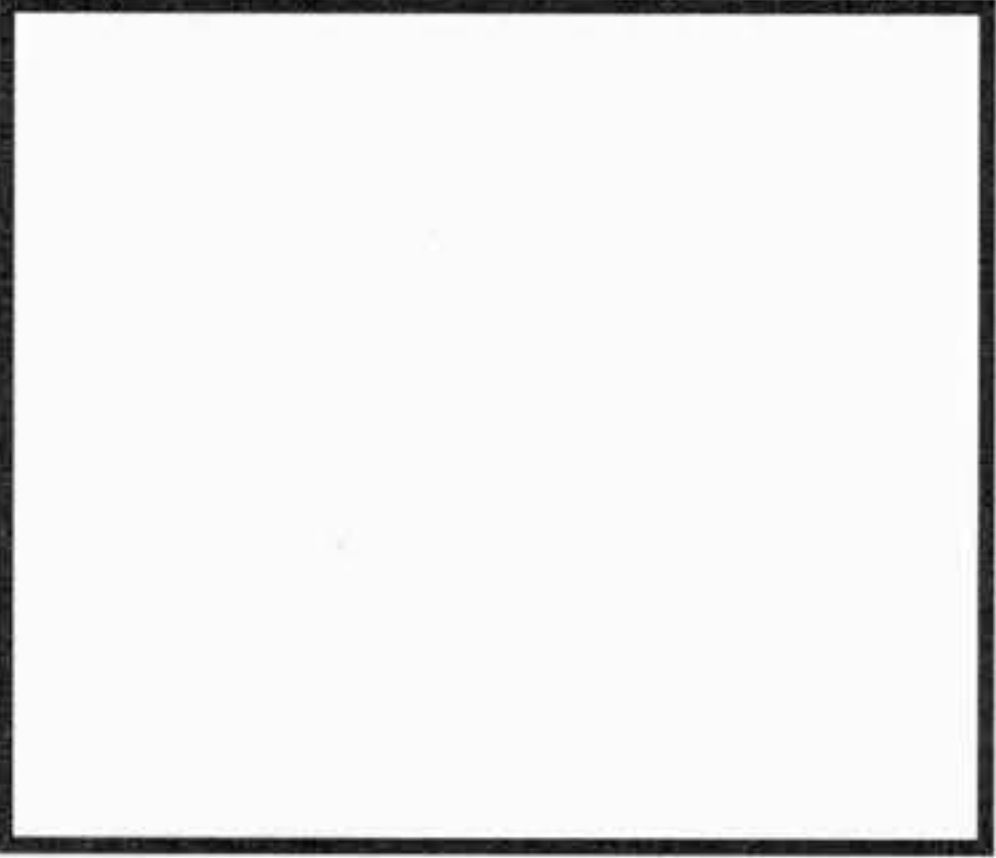
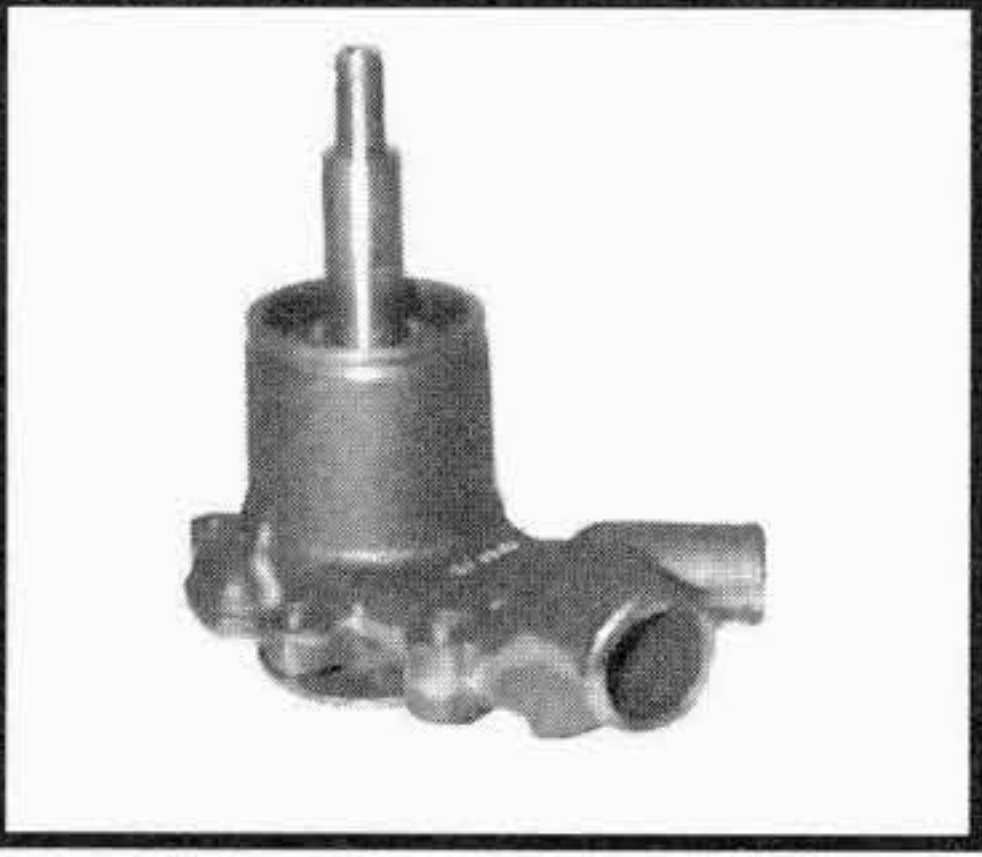
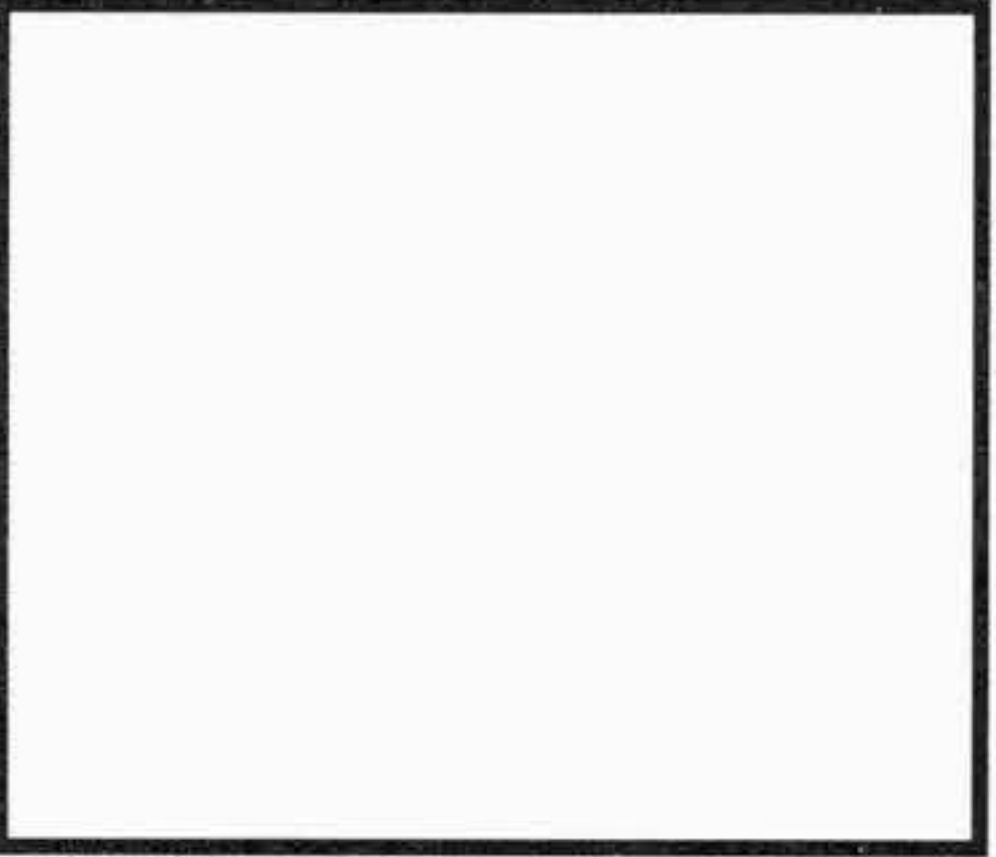

TIPO O MODELLO TYPE OU MODELE TYPE OR MODEL	MOTORE MOTEUR ENGINE	POMPA ACQUA POMPE A EAU WATER PUMP OMP REF. / O.EM. REF	KIT RIPARAZIONE NECESSAIRE DE REP. REPAIR KIT OMP REF. / O.EM. REF
	4.192 4.203 4.203.2 D4.203	<p><b>159.475</b> U5MW0062 SENZA PULEGGIA / WITHOUT PULLEY</p> 	<p><b>152.259</b> U7LW0047</p> 
	T4.236 4.248 A4.248	<p><b>159.150</b> 41313218 SENZA PULEGGIA / WITHOUT PULLEY</p>  <p>ad esaurimento sost. da / will be supersided by <b>159.470</b> 41313237</p>	<p><b>152.255</b> U7LW0059</p> 
	4.248 A4.248 T4.236	<p><b>159.470</b> 41313237 SENZA PULEGGIA / WITHOUT PULLEY</p>  <p>ALBERO / SHAFT L = 159 MM</p>	<p><b>152.255</b> U7LW0059</p> 
	A4.248	<p><b>159.350</b> 41313233 SENZA PULEGGIA / WITHOUT PULLEY</p>  <p>ALBERO / SHAFT L = 198,65 MM</p>	<p><b>152.256</b> U7LW0031</p> 

I ricambi non sono originali ma adattabili . Ogni riferimento originale é assolutamente indicativo .  
Spare parts are not original but perfectly suitable . Every original part number has to be considered for reference purpose only .

SUITABLE









**PERKINS**

ENGINES

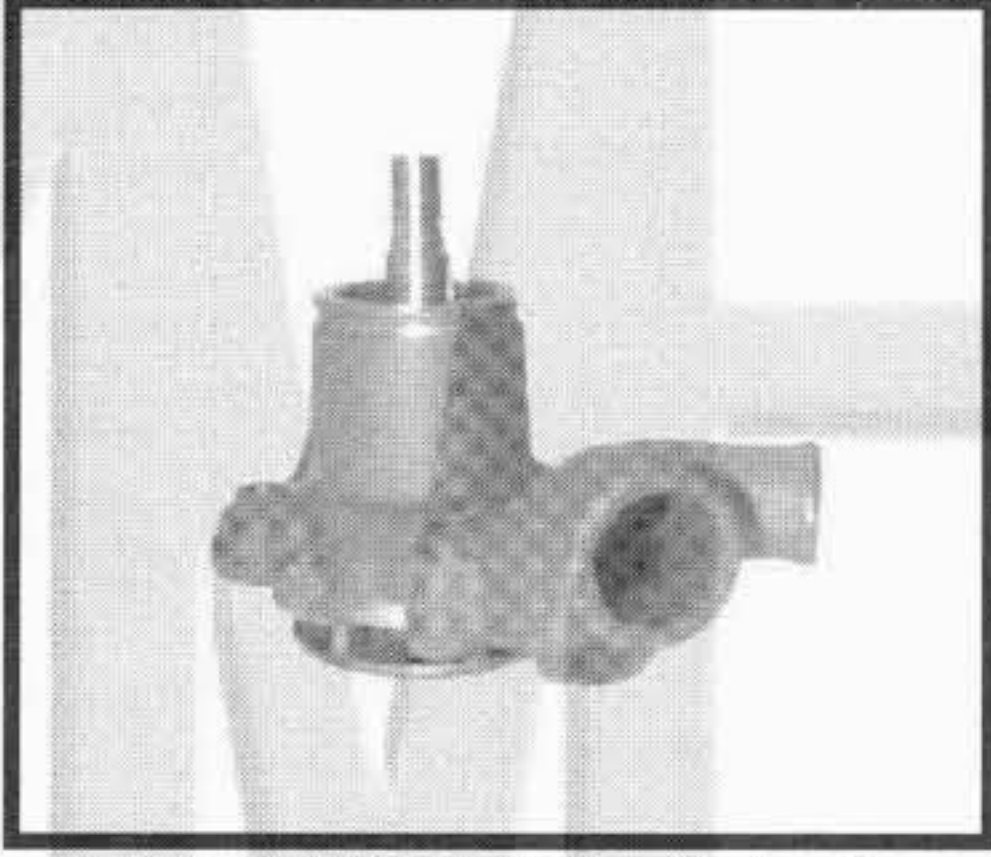
Tel: +44(0)1925 850082 Fax: +(0)44 1925 850083

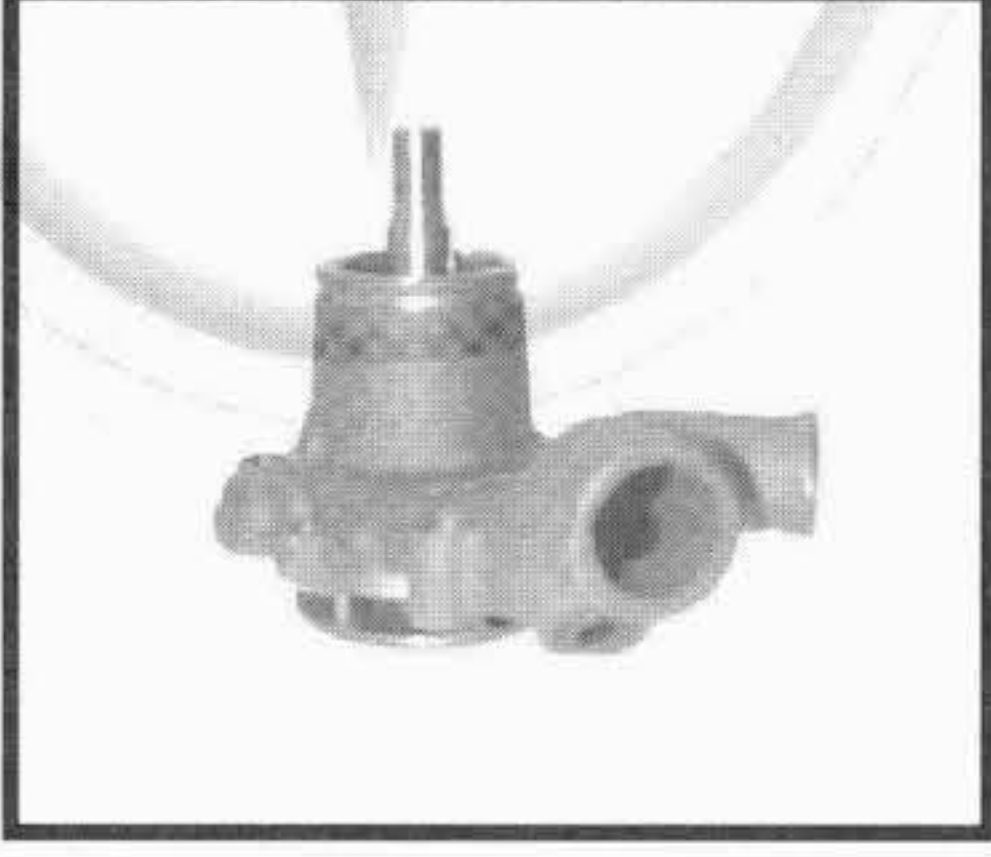
www.spwaterpumps.co.uk

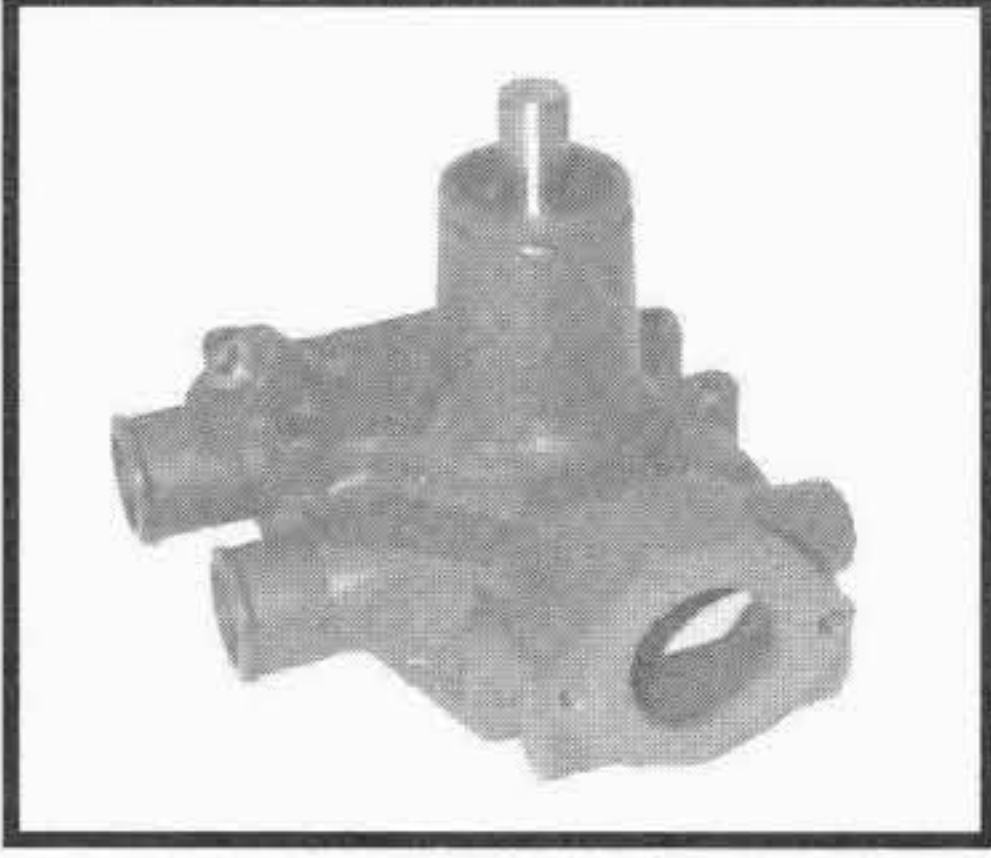

TIPO O MODELLO TYPE OU MODELE TYPE OR MODEL	MOTORE MOTEUR ENGINE	POMPA ACQUA POMPE A EAU WATER PUMP	KIT RIPARAZIONE NECESSAIRE DE REP. REPAIR KIT
	A4.212 4.236 4.236M 4.236.0 A4.236 4.248 4.248.2 A4.248	<b>259.450</b> 41313231P CON PULEGGIA / WITH PULLEY  <b>159.490</b> 4131A034 SENZA PULEGGIA / WITHOUT PULLEY	<b>152.183</b> U7LW0058 ALBERO / SHAFT Ø= 5/8 - 18 FIL. X 1"  <b>152.112</b> U7LW0025 ALBERO / SHAFT Ø= 1/2 - 20 FIL. X 1"
	T4.236 4.248	<b>259.380</b> 41313212 SENZA PULEGGIA / WITHOUT PULLEY  ad esaurimento sost. da / will be supersided by <b>159.380</b> 41313228	<b>152.183</b> U7LW0058 
	T4.236 4.248	<b>159.380</b> 41313228 SENZA PULEGGIA / WITHOUT PULLEY 	<b>152.183</b> U7LW0058 
	A4.300 4.318	<b>159.140</b> U5MW0014 SENZA PULEGGIA / WITHOUT PULLEY  --- 41312419 CON PULEGGIA / WITH PULLEY	<b>152.155</b> U7LW0055 

I ricambi non sono originali ma adattabili . Ogni riferimento originale é assolutamente indicativo .

Spare parts are not original but perfectly suitable . Every original part number has to be considered for reference purpose only .

SUITABLE



# PERKINS

ENGINES

Tel: +44(0)1925 850082 Fax: +44(0)1925 850083

www.spwaterpumps.co.uk

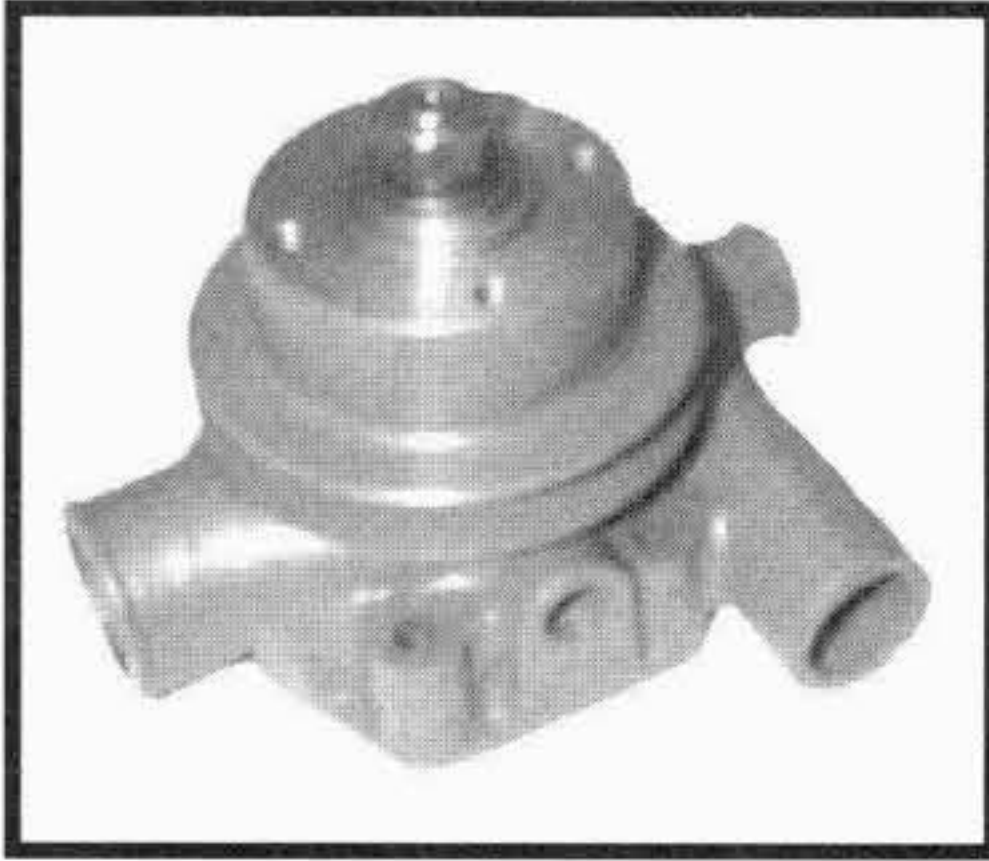
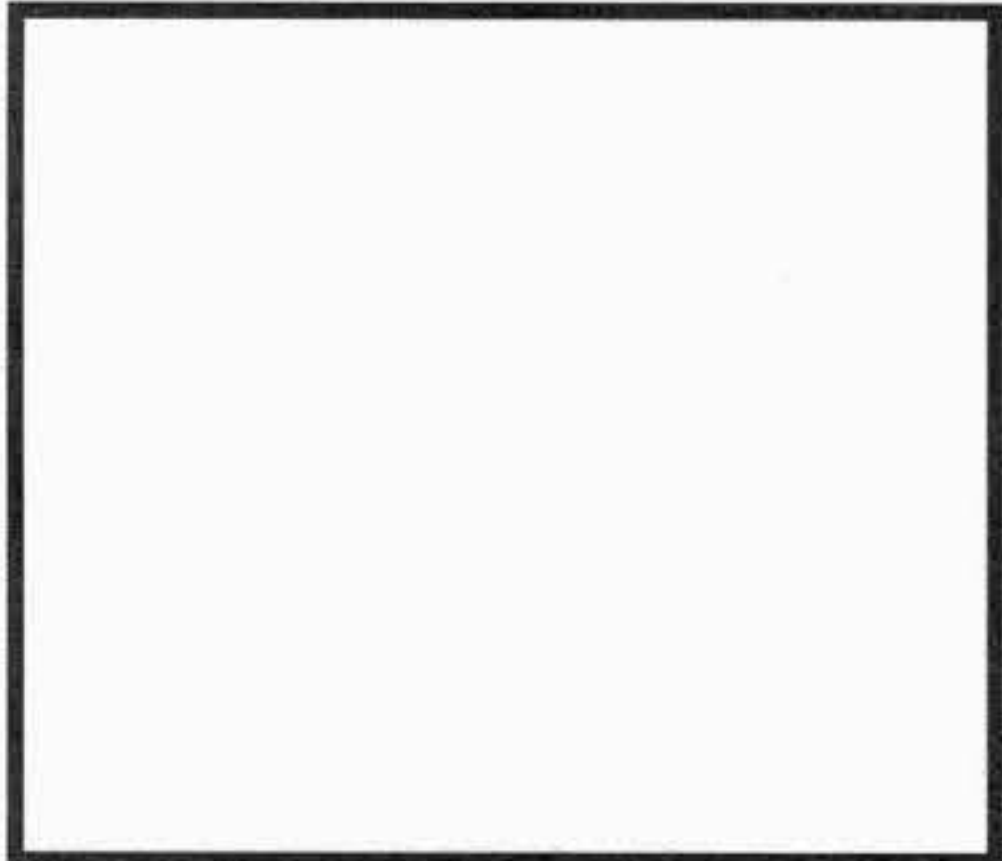
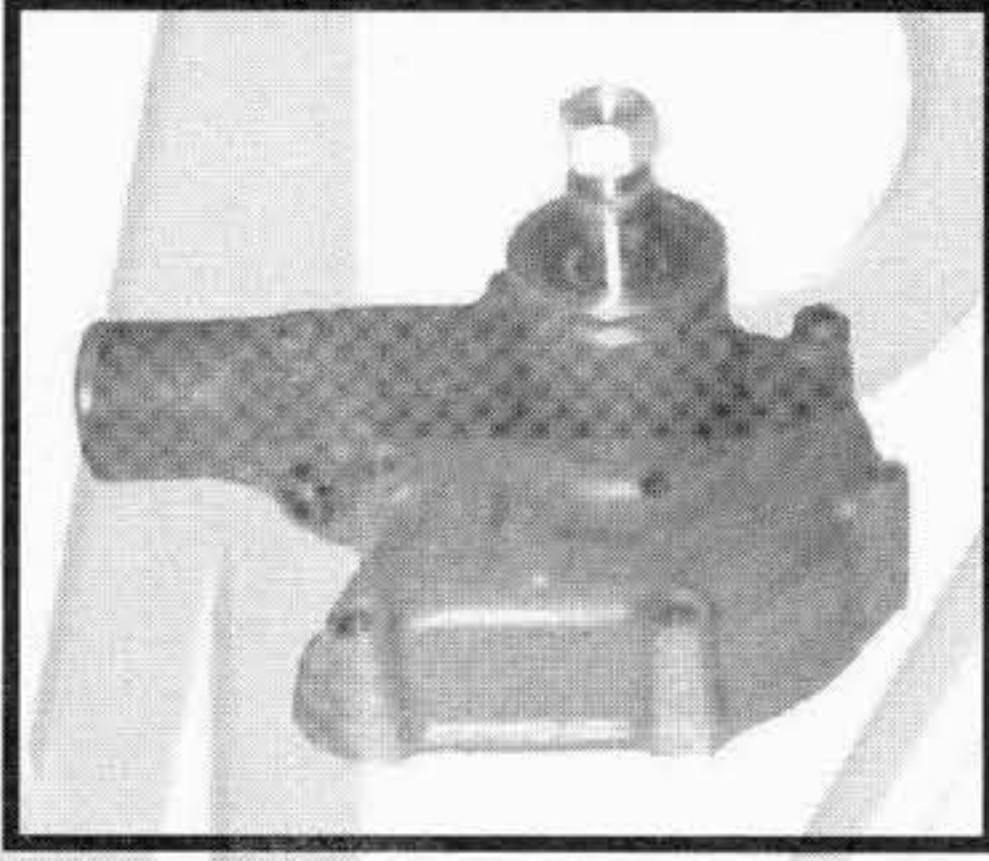

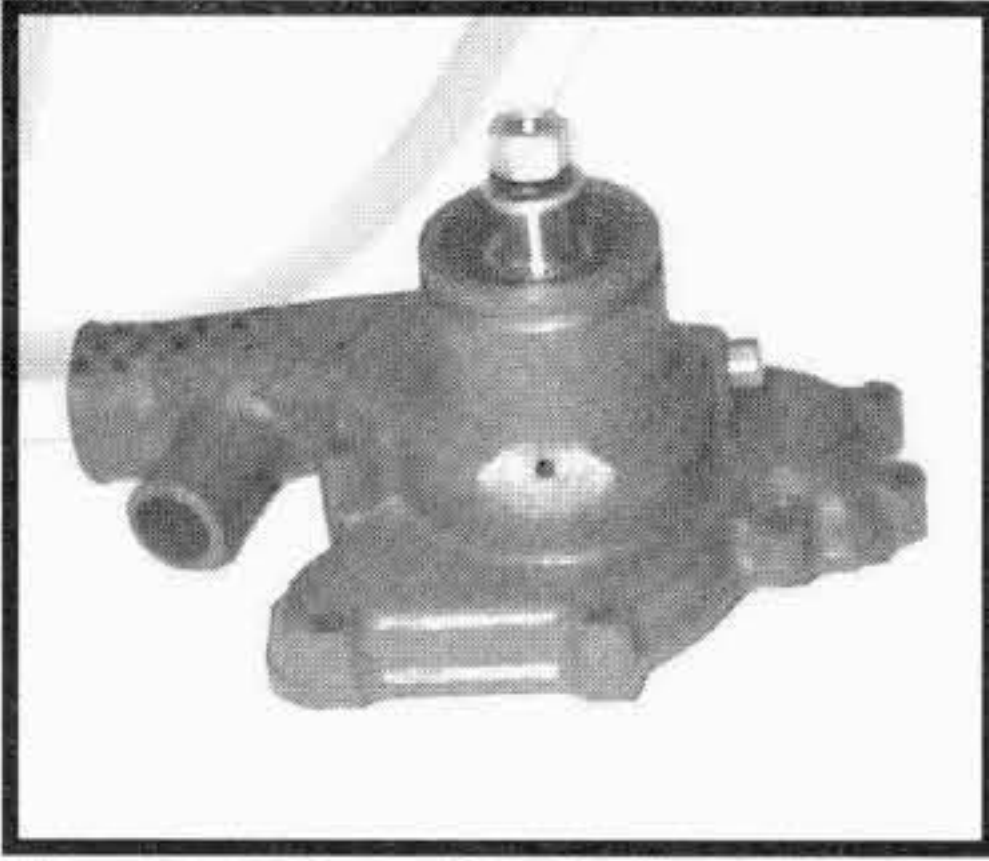
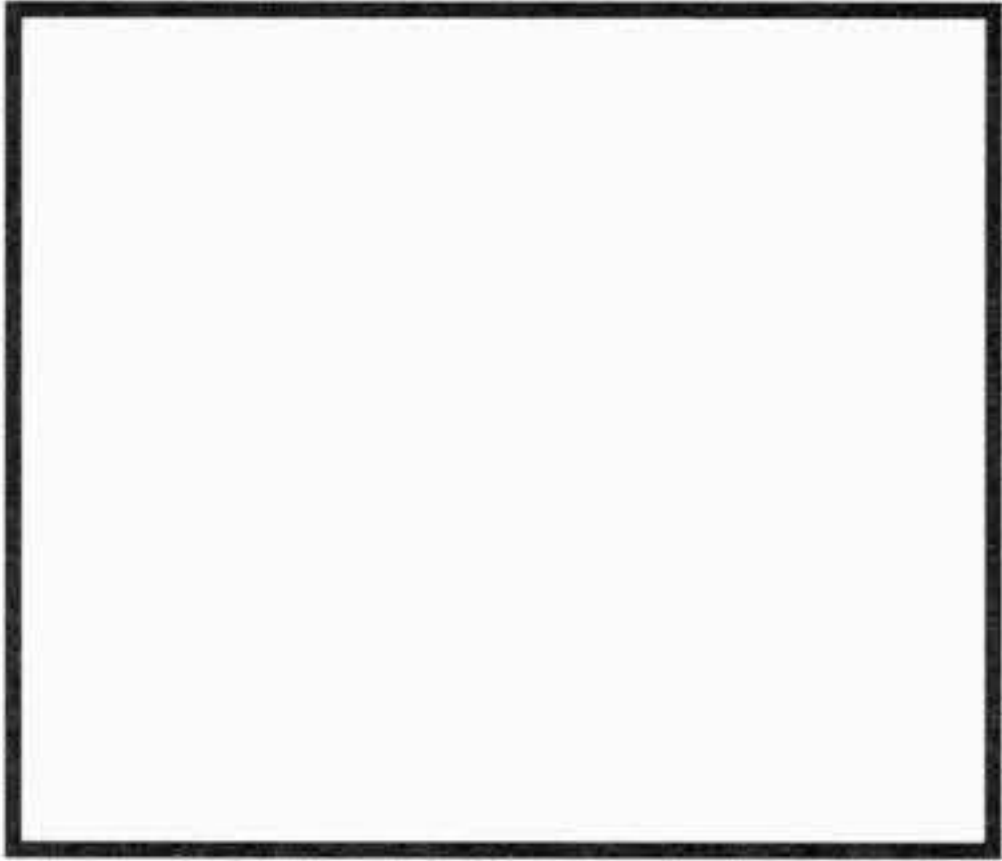
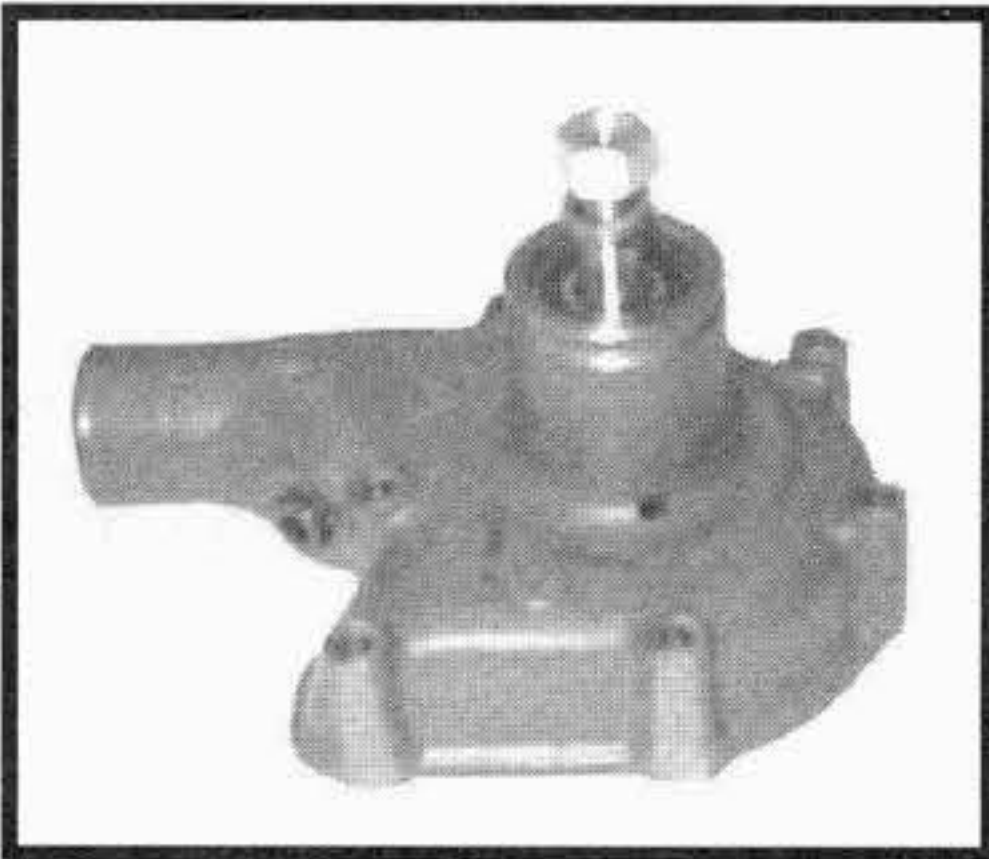
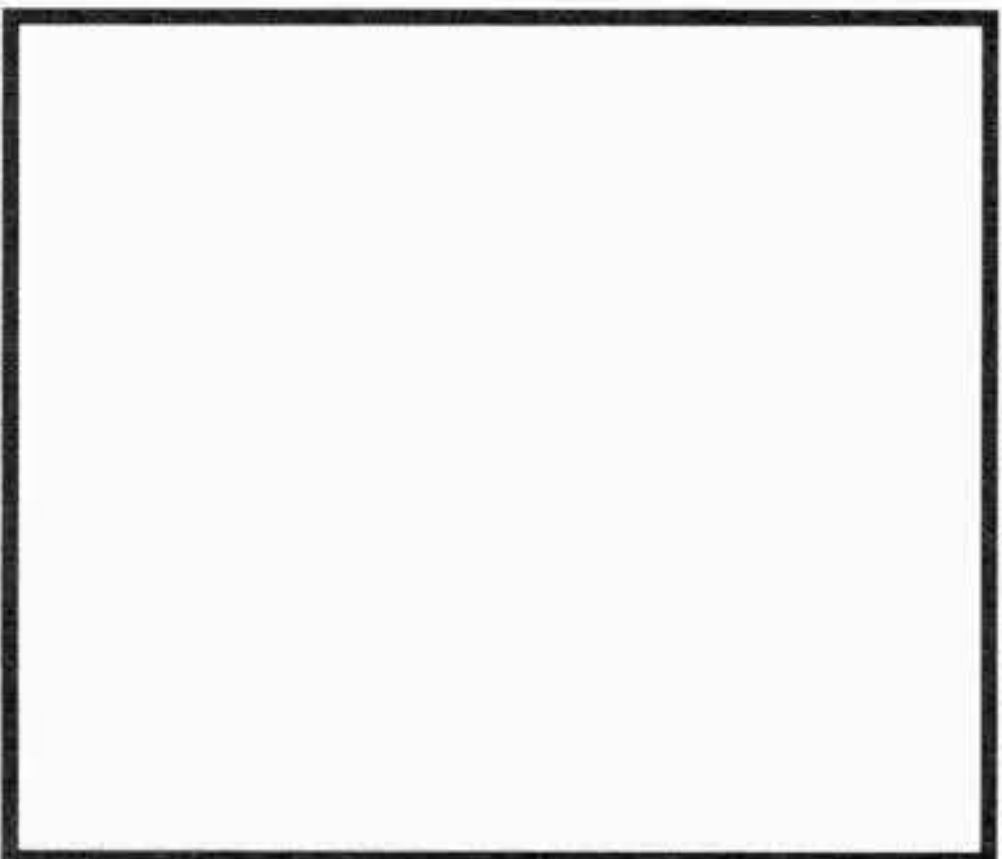
TIPO O MODELLO TYPE OU MODELE TYPE OR MODEL	MOTORE MOTEUR ENGINE	POMPA ACQUA POMPE A EAU WATER PUMP OMP REF. / O.EM. REF	KIT RIPARAZIONE NECESSAIRE DE REP. REPAIR KIT OMP REF. / O.EM. REF
	6.288	<b>259.110</b> 41312518 CON PULEGGIA / WITH PULLEY	<b>152.152</b> 58307
	6.305	 <b>159.110</b> U5MW0019 SENZA PULEGGIA / WITHOUT PULLEY	
	6.354	<b>159.090</b> 41313045 SENZA PULEGGIA / WITHOUT PULLEY	<b>152.097</b> U7LW0009
	6.354M		
	6.354.0		
	A6.354		
	T6.354		
	T6.354M		
	T6.354.0		
	6.354.4	<b>159.260</b> 41313047 SENZA PULEGGIA / WITHOUT PULLEY	<b>252.243</b> U7LW0020
	A6.354.4		
	T6.354.4		
	6.372.4		
	A6.372.4		
	6.354.2	<b>159.070</b> 41313038 SENZA PULEGGIA / WITHOUT PULLEY	<b>152.097</b> U7LW0009
	AT6.354		
	T6.354.1		
	6.372		
	6.372.1		
	A6.372		

I ricambi non sono originali ma adattabili . Ogni riferimento originale é assolutamente indicativo .  
Spare parts are not original but perfectly suitable . Every original part number has to be considered for reference purpose only .

SUITABLE

# PERKINS

## ENGINES

Tel: +44(0)1925 850082 Fax: +(0)44 1925 850083

www.spwaterpumps.co.uk

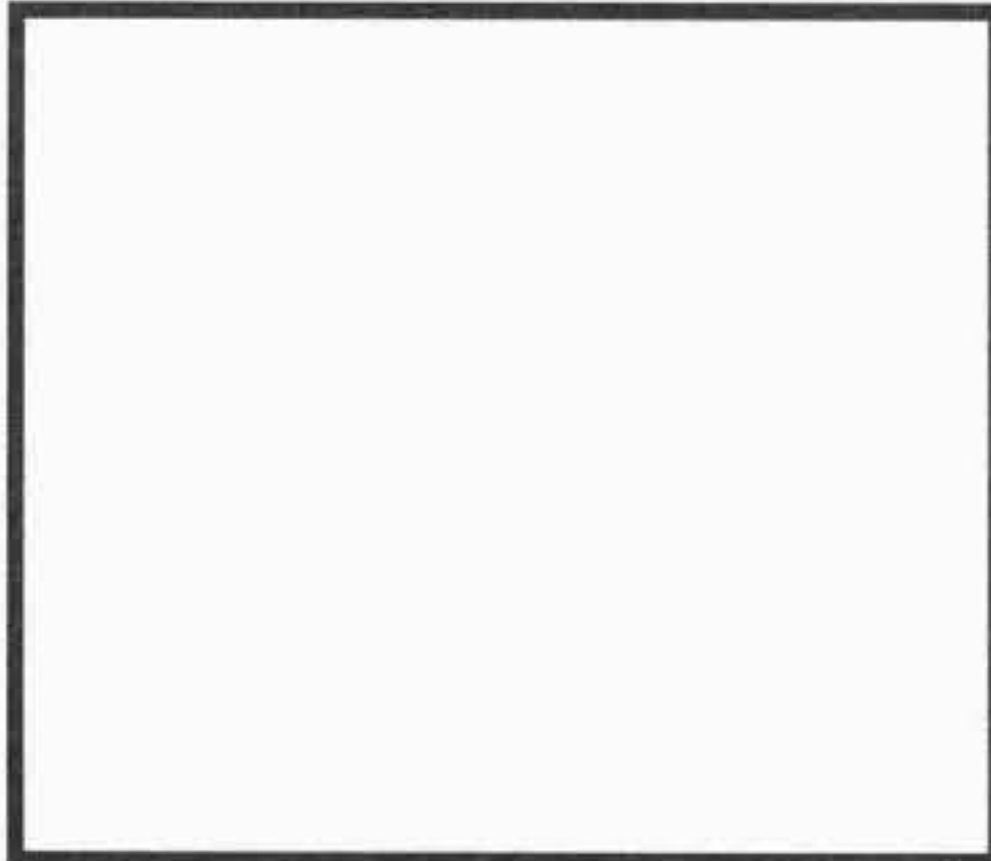
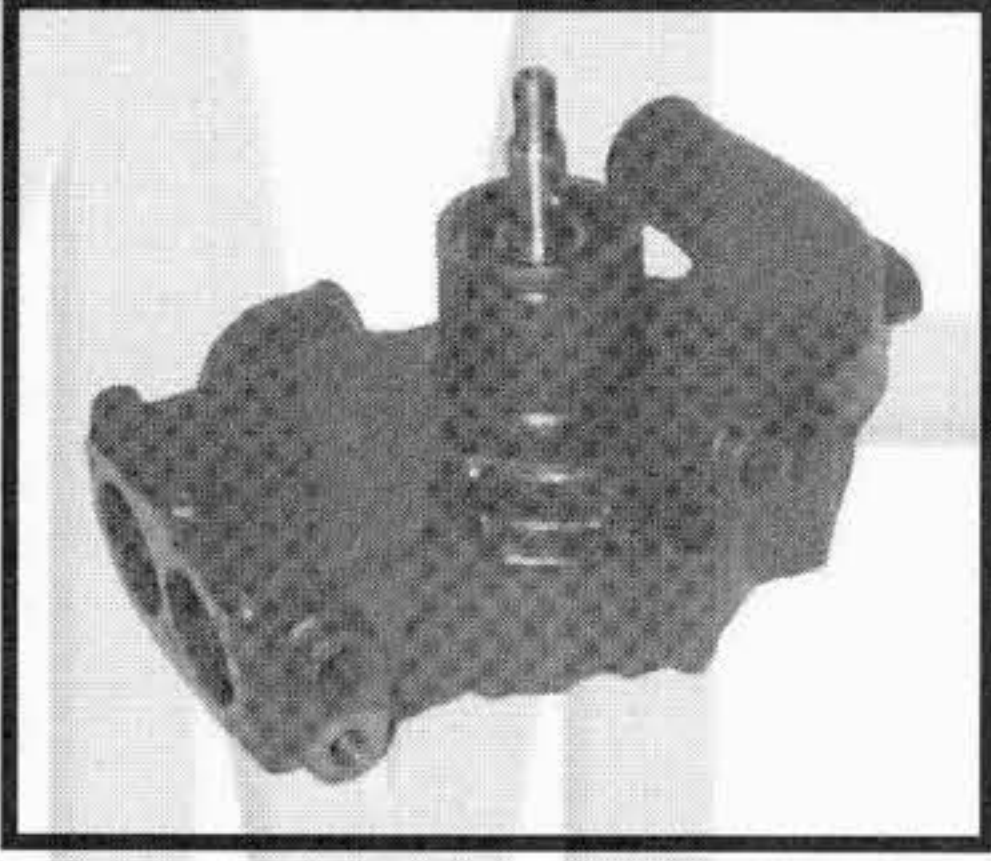
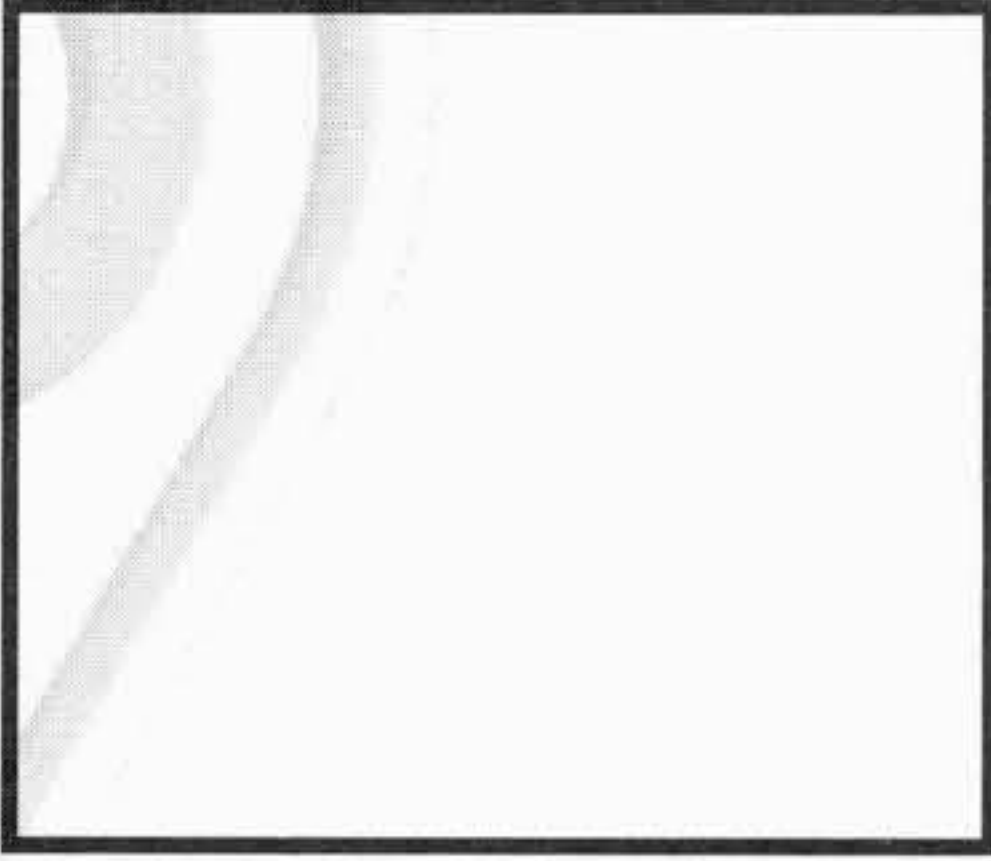
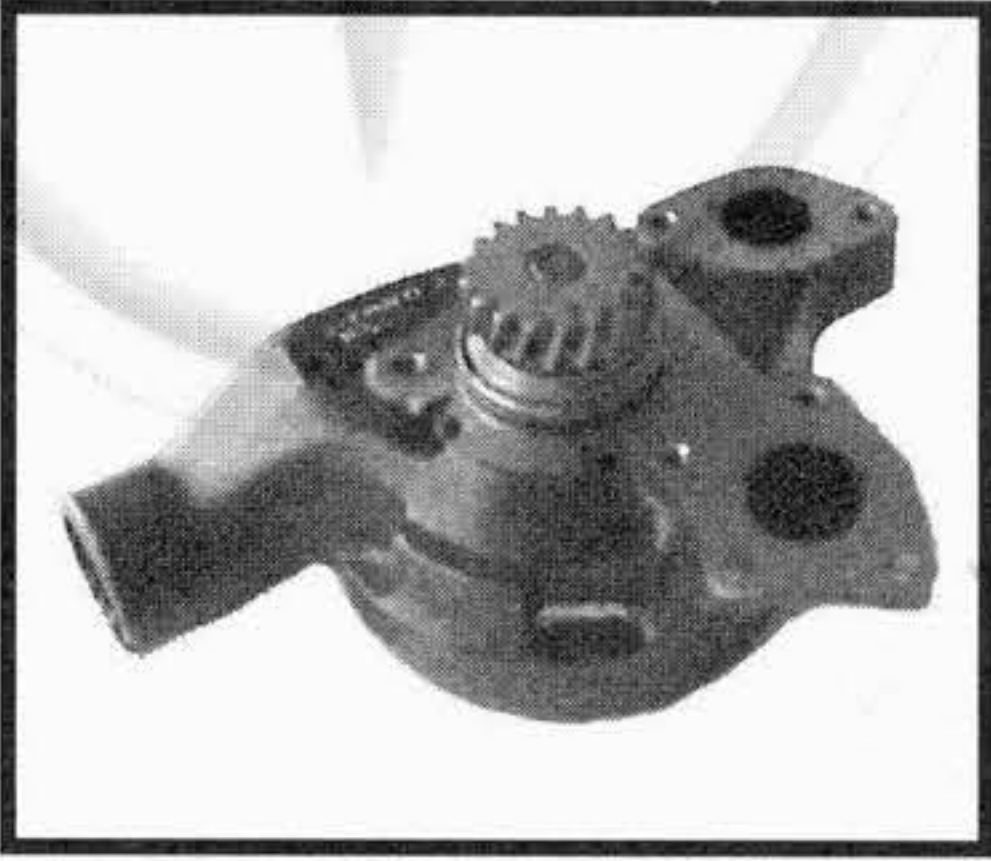
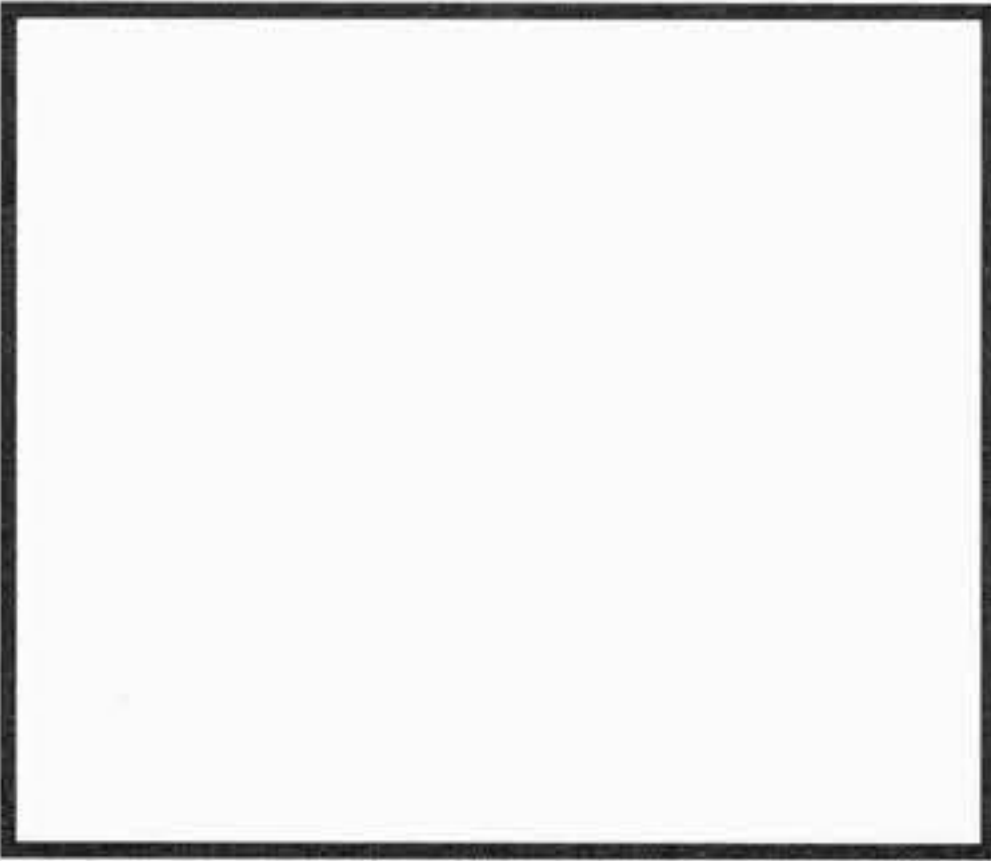
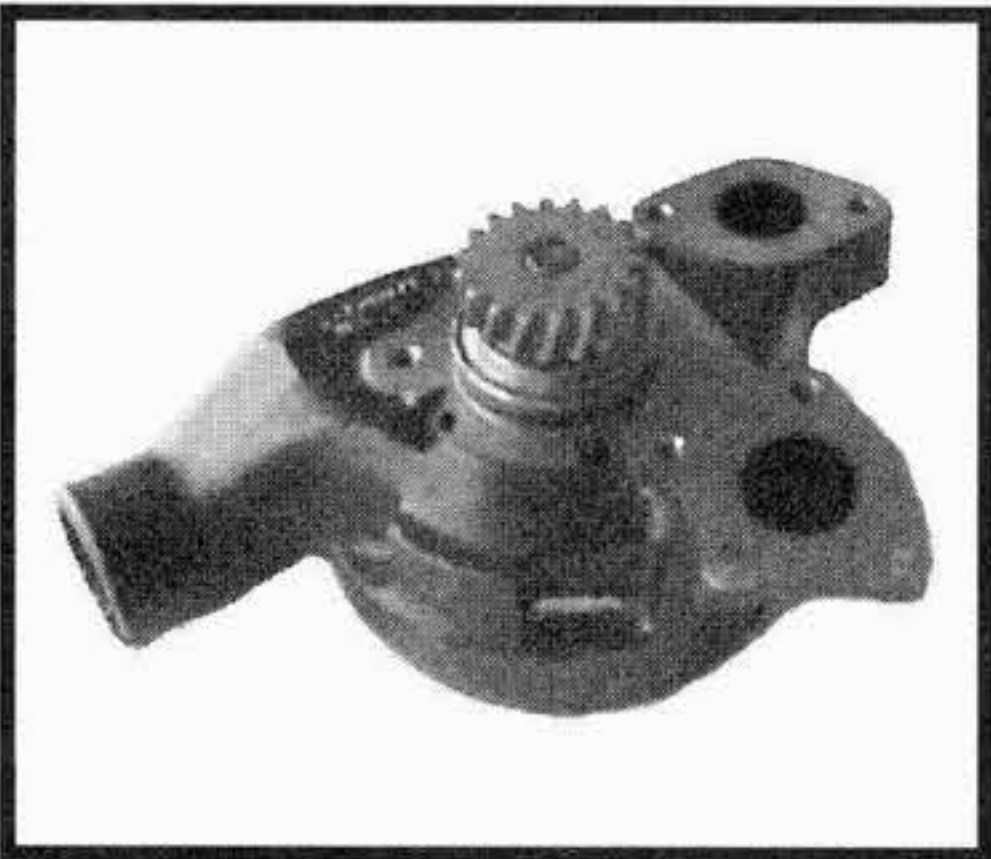
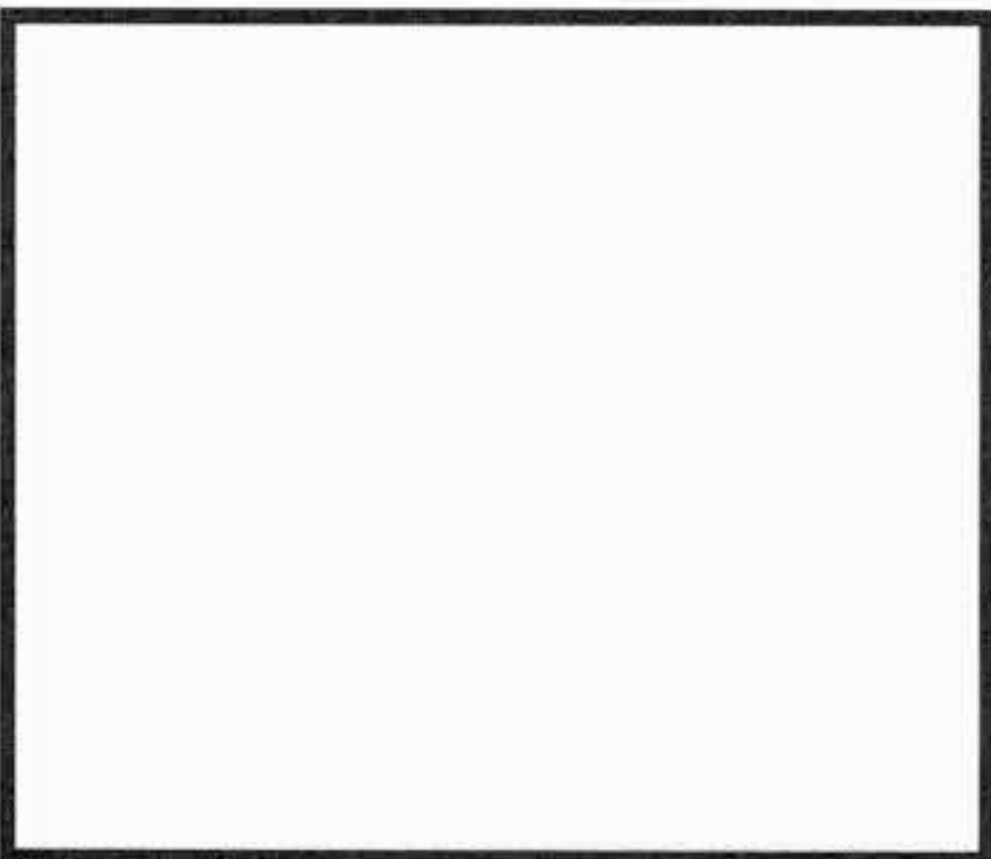

TIPO O MODELLO TYPE OU MODELE TYPE OR MODEL	MOTORE MOTEUR ENGINE	POMPA ACQUA POMPE A EAU WATER PUMP	KIT RIPARAZIONE NECESSAIRE DE REP. REPAIR KIT
	A6.354  A6.354.1  AT6.354.1	<p><b>159.230</b> U5MW0016</p> <p>SENZA PULEGGIA / WITHOUT PULLEY</p> 	<p><b>252.136</b> U7LW0024</p> 
	6.354.4  A6.354.4  AT6.354.4  T6.354.4	<p><b>159.355</b> 41313027</p> <p>SENZA PULEGGIA / WITHOUT PULLEY</p> 	<p><b>152.153</b> U7LW0015</p> 
<p><b>NEW !!</b></p>	1004.4  PHASER 4 cyl.	<p><b>159.510</b> 4131E012</p> 	<p><b>152.260</b> U7LW0071</p> 
<p><b>NEW !!</b></p>	1006.6  PHASER 6 cyl.	<p><b>159.500</b> 4131E011</p> 	<p><b>152.261</b> U7LW0087</p> 

I ricambi non sono originali ma adattabili . Ogni riferimento originale é assolutamente indicativo .  
 Spare parts are not original but perfectly suitable . Every original part number has to be considered for reference purpose only .





**SECTION 36**

**APPLICATION**

**RENAULT**

**DMA**

**WATER PUMPS WASSERPUMPEN  
POMPE A EAU BOMBA DE AGUA  
POMPA ACQUA**

**S.P. WATER PUMPS LTD**  
18 Tatton Court, Kingsland Grange, Woolston,  
Warrington, Cheshire. ENGLAND. WAI 4RR  
TEL: +44(0) 1925 850082 Fax: +44(0) 1925 850083  
Email:sales@spwaterpumps.co.uk Web Site:www.spwaterpumps.co.uk



SUITABLE







# RENAULT DMA

TRACTORS

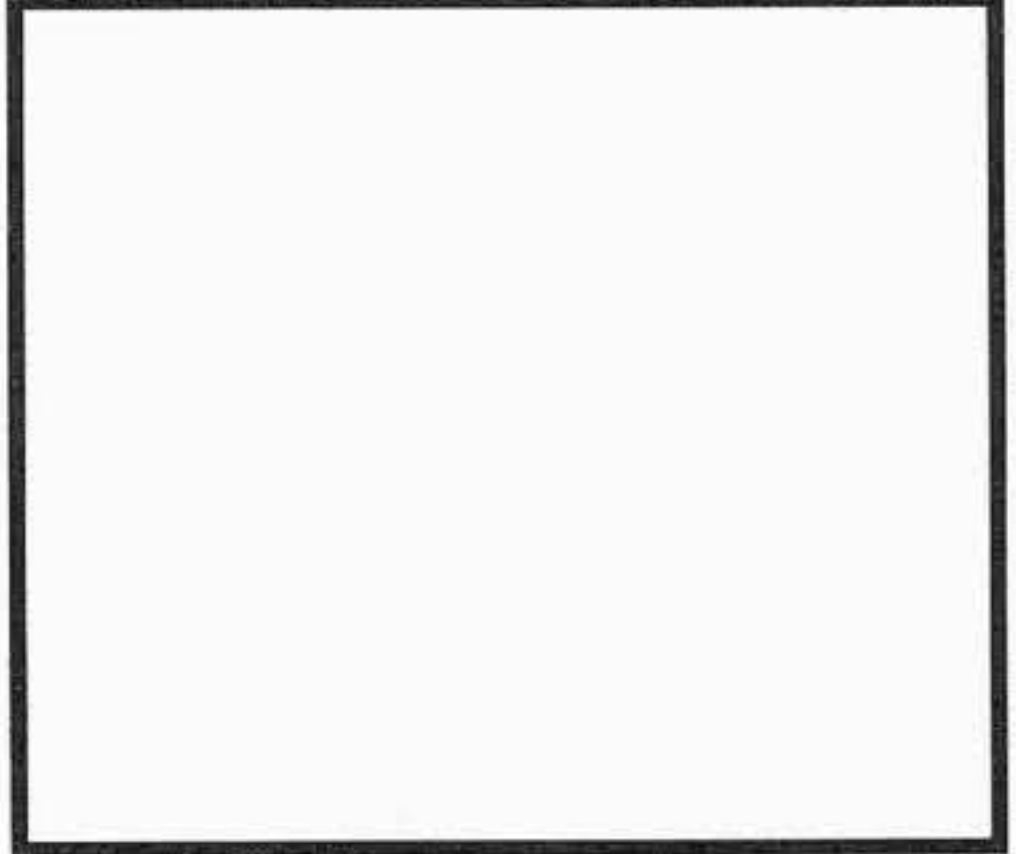
Tel: +44(0)1925 850082 Fax: +(0)44 1925 850083

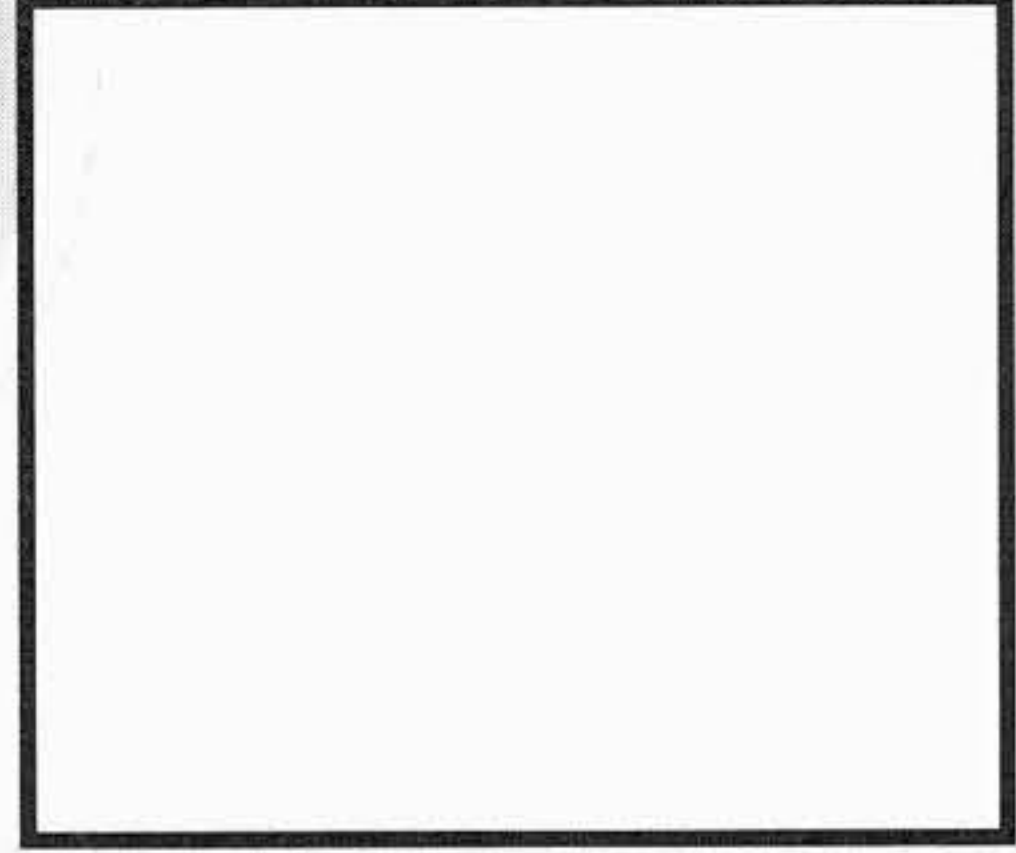
www.spwaterpumps.co.uk

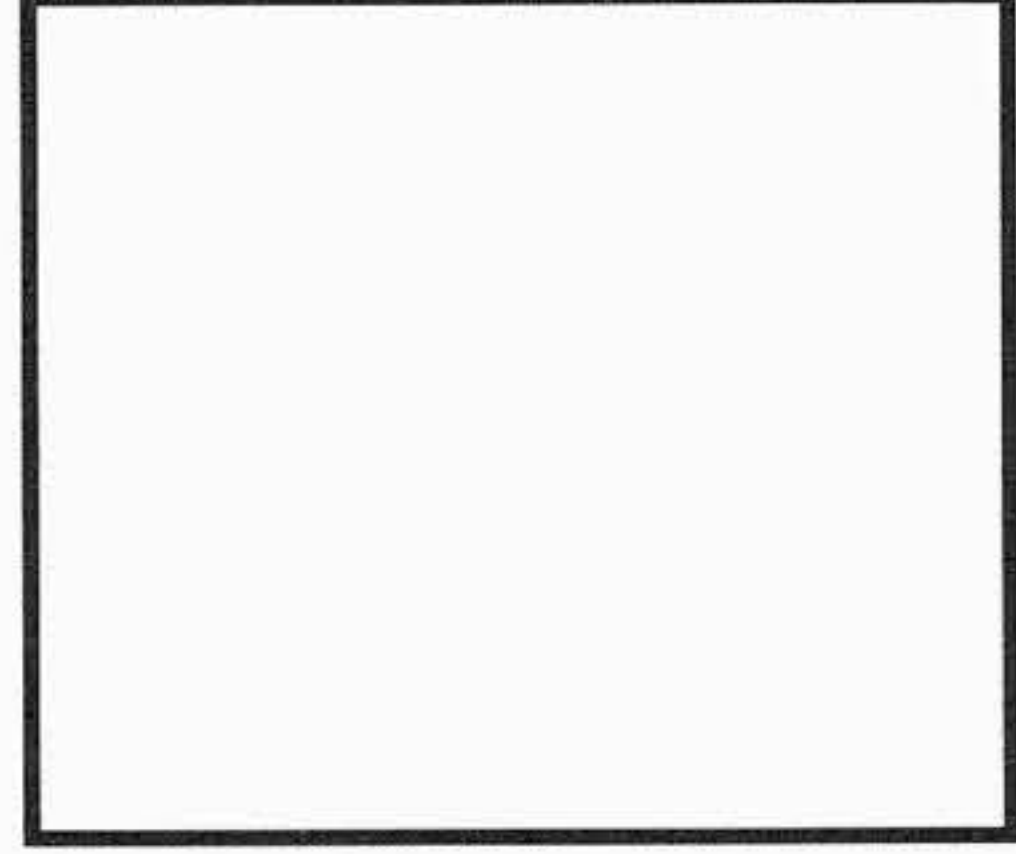

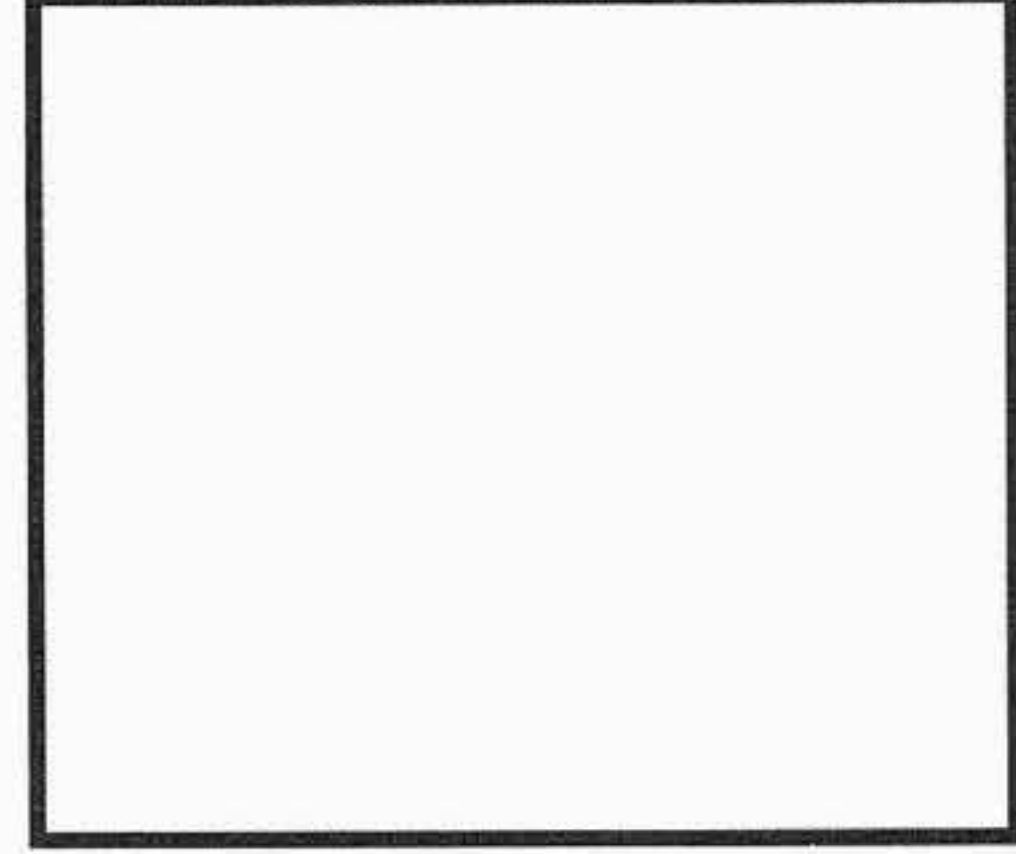
TIPO O MODELLO TYPE OU MODELE TYPE OR MODEL	MOTORE MOTEUR ENGINE	POMPA ACQUA POMPE A EAU WATER PUMP OMP REF. / O.EM. REF	KIT RIPARAZIONE NECESSAIRE DE REP. REPAIR KIT OMP REF. / O.EM. REF
R 30	PERKINS	<b>283.170</b> 01.22.663.600 	<b>282.103</b> --- 
R 30	PERKINS	<b>283.200</b> 01.22.663.500 	<b>282.103</b> --- 
R 30	PERKINS	<b>283.210</b> 01.23.100.200 	<b>282.103</b> --- 
R 30	PERKINS	<b>283.220</b> 01.23.166.400 	<b>282.103</b> --- 

I ricambi non sono originali ma adattabili . Ogni riferimento originale é assolutamente indicativo .  
 Spare parts are not original but perfectly suitable . Every original part number has to be considered for reference purpose only .



SUITABLE

# RENAULT DMA TRACTORS

Tel: +44(0)1925 850082 Fax: +44(0)1925 850083

www.spwaterpumps.co.uk

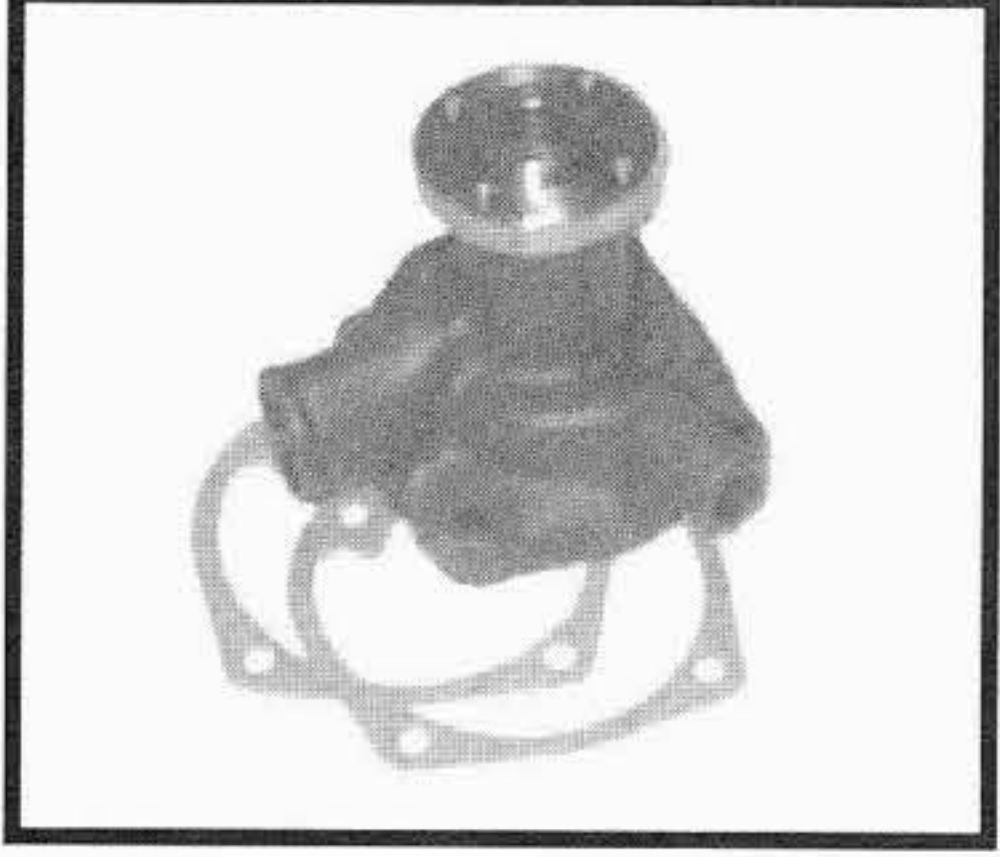
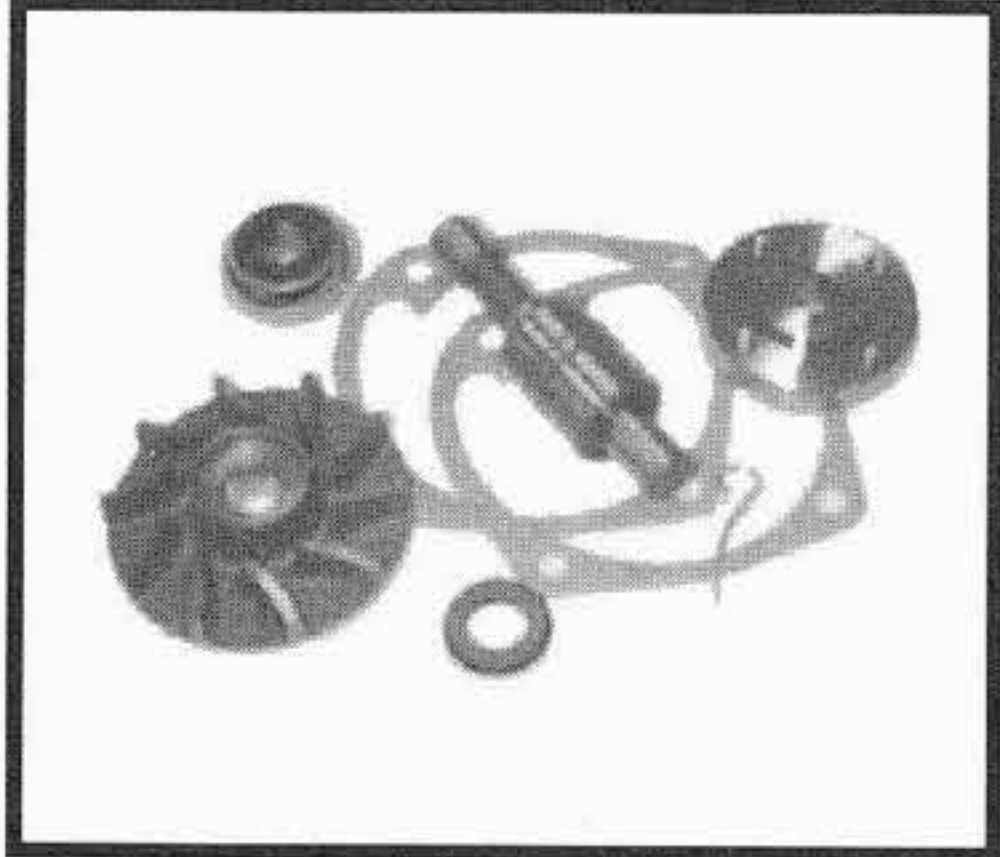
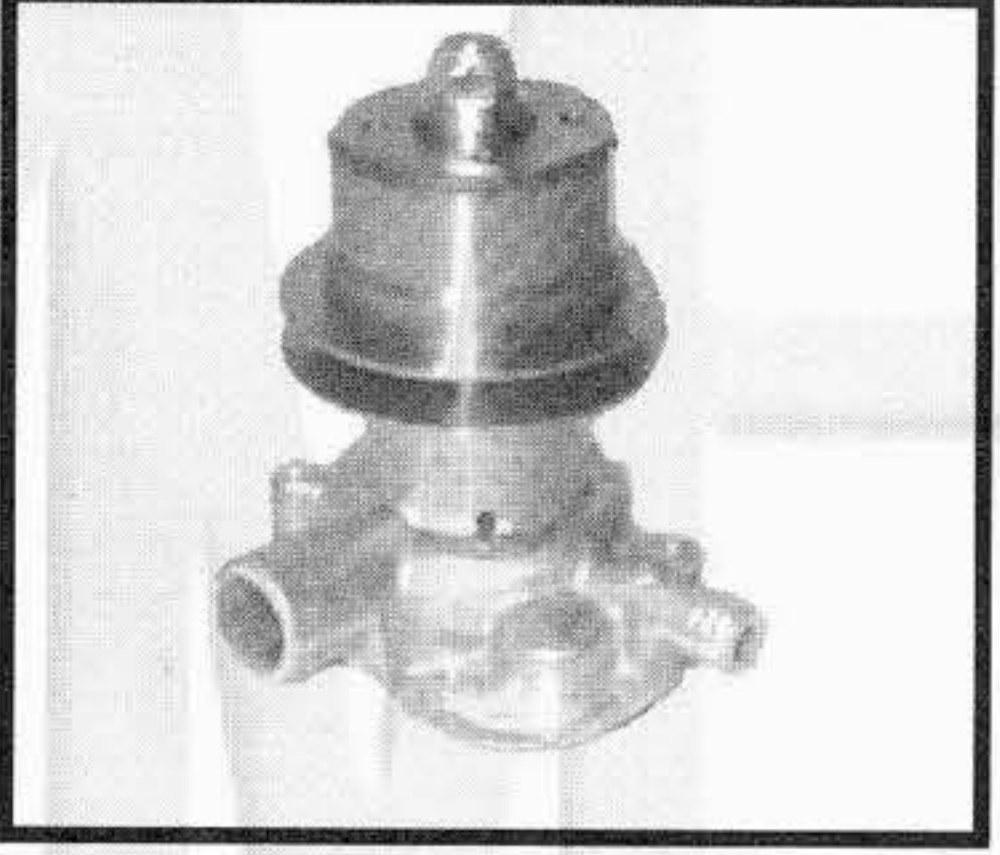

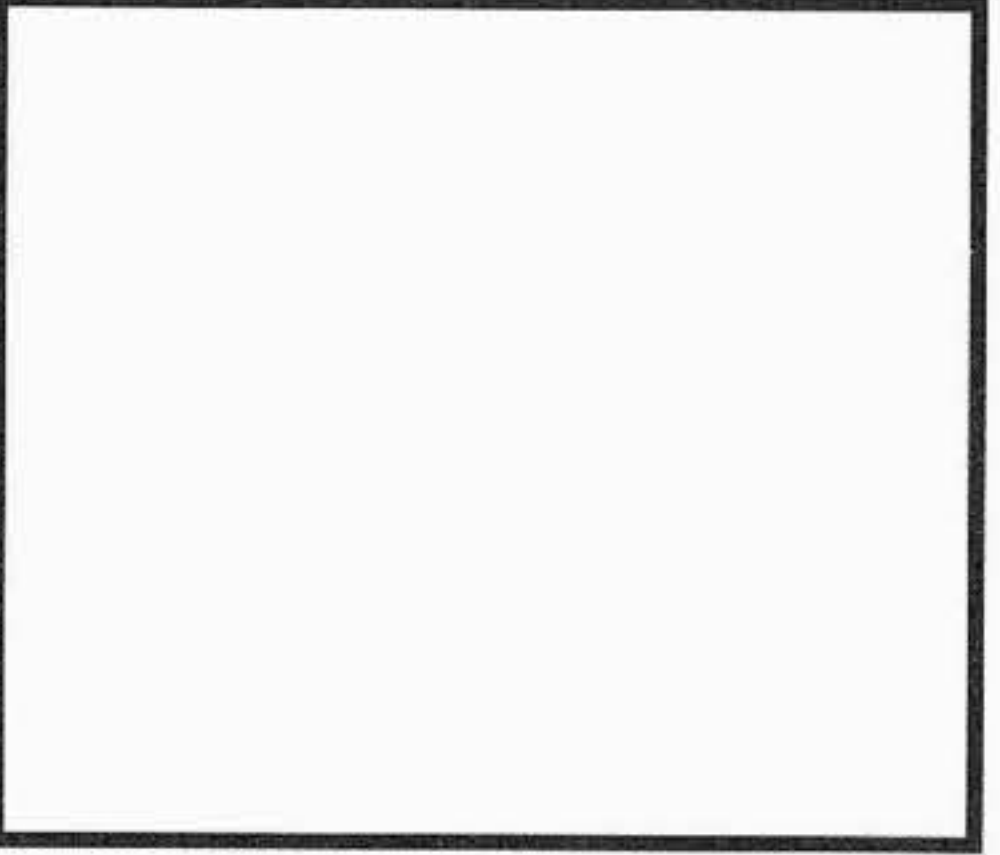
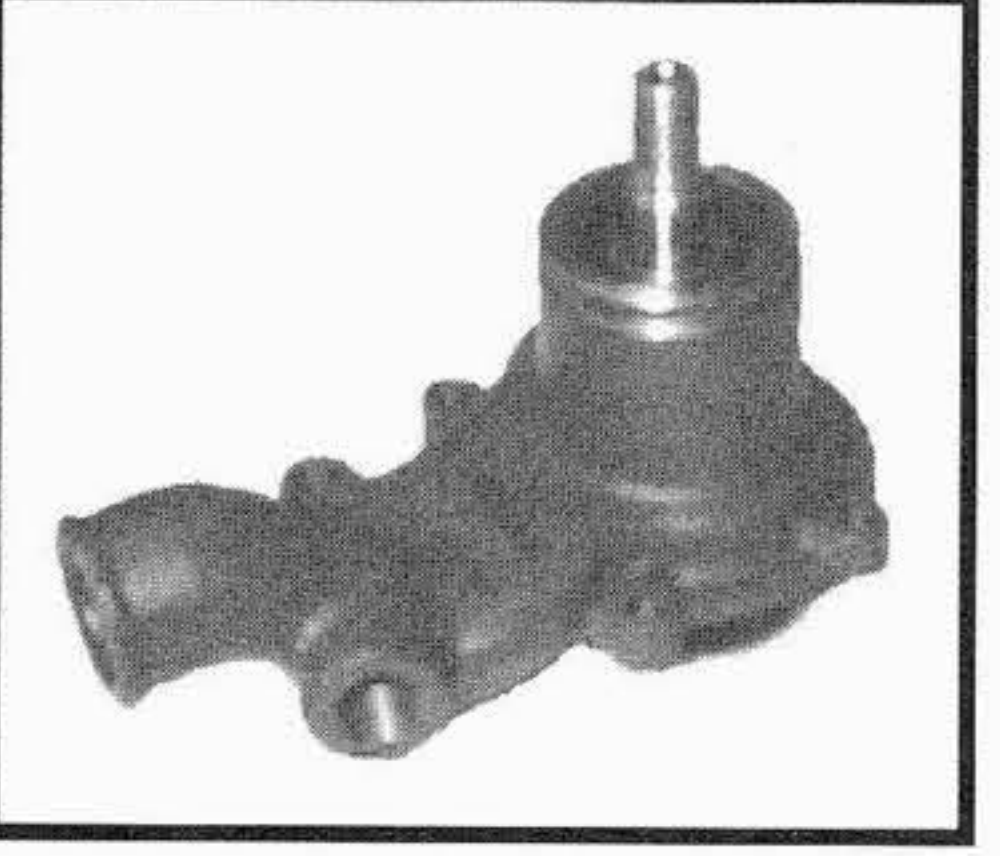
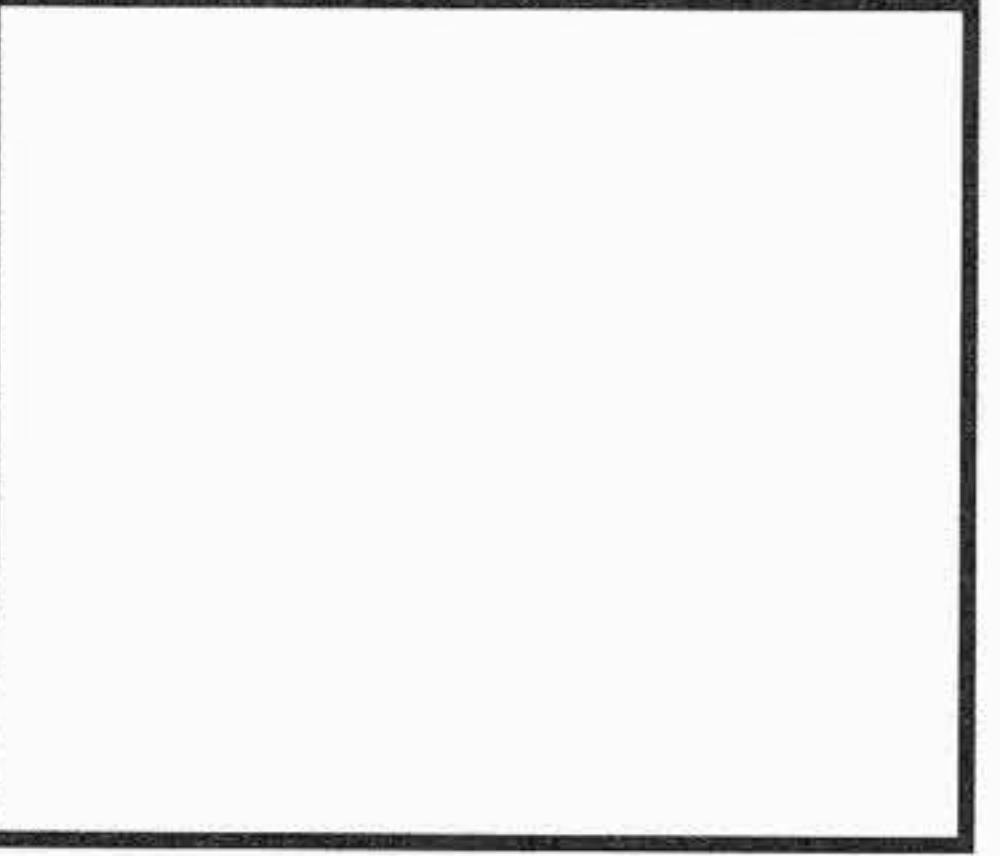
TIPO O MODELLO TYPE OU MODELE TYPE OR MODEL	MOTORE MOTEUR ENGINE	POMPA ACQUA POMPE A EAU WATER PUMP OMP REF. / O.EM. REF	KIT RIPARAZIONE NECESSAIRE DE REP. REPAIR KIT OMP REF. / O.EM. REF
551 - 556 - 651 - 651 / 4 - 656 751 - 751 / 4 - 851 - 851 / 4 951 - 951 / 4 - 1151 / 4	MWM D 226.3 TD 226.4 D 226.6 D 227.4 D 227.6	<b>283.160</b> 77.01.022.333 	<b>282.090</b> 77.01.201.007 
tutti i modelli con il motore all models with engine	----> 712.01	<b>283.180</b> 09.87.045.200 	<b>282.102</b> 50.00.336.069 
tutti i modelli con il motore all models with engine	----> 591	<b>283.190</b> 09.87.045.400 	<b>282.102</b> 50.00.336.069 
tutti i modelli con il motore all models with engine	<b>PERKINS</b> 4.248 - A4.248	<b>289.490</b> 60.05.005.033 	--- 

I ricambi non sono originali ma adattabili . Ogni riferimento originale é assolutamente indicativo .  
 Spare parts are not original but perfectly suitable . Every original part number has to be considered for reference purpose only .

SUITABLE





# RENAULT DMA

TRACTORS

Tel: +44(0)1925 850082 Fax: +(0)44 1925 850083

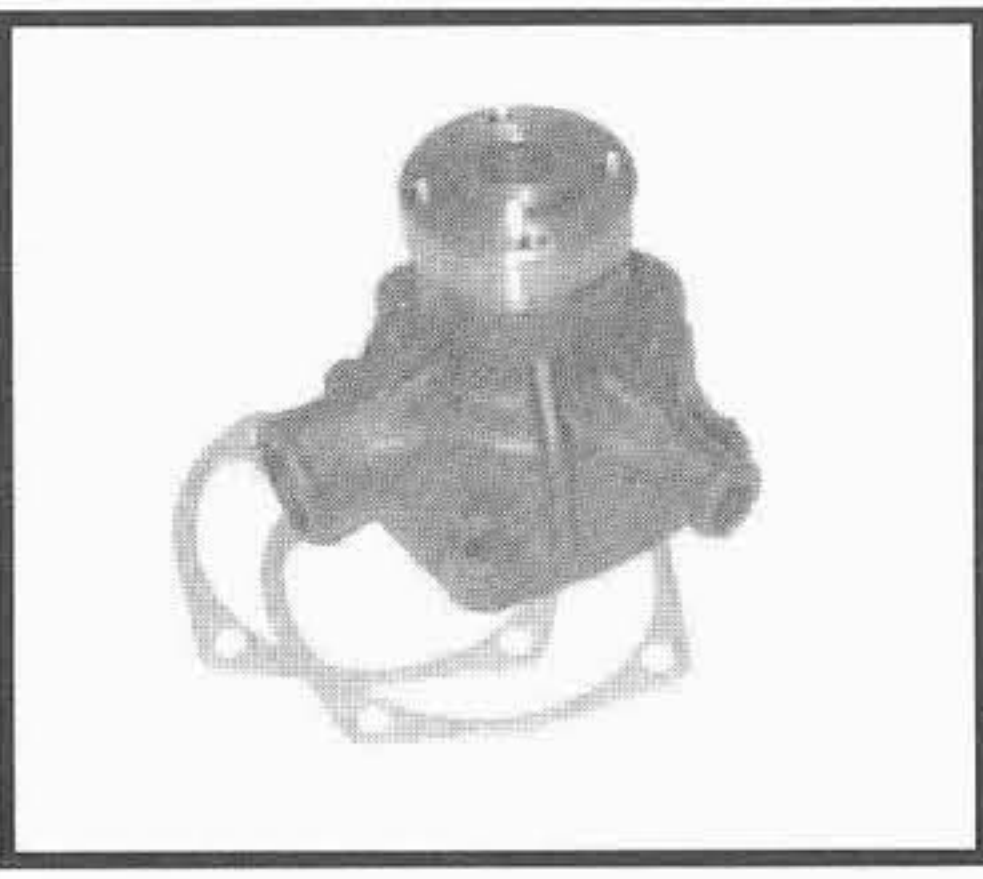
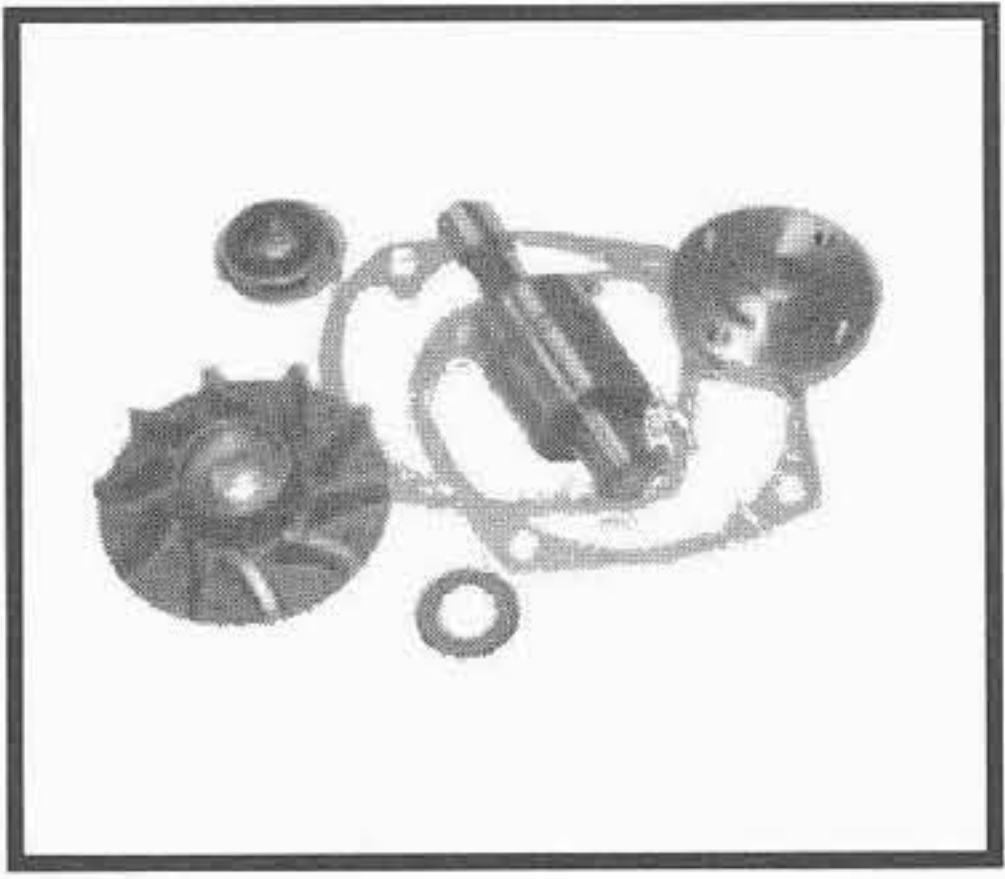
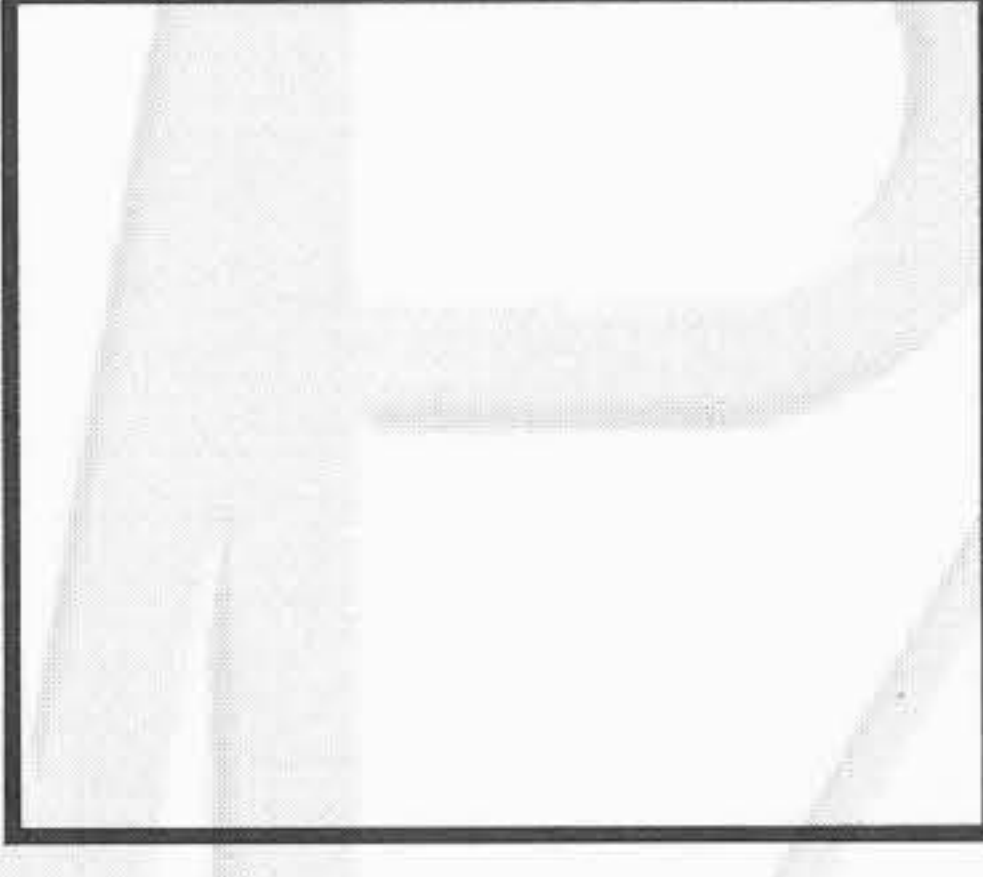
www.spwaterpumps.co.uk

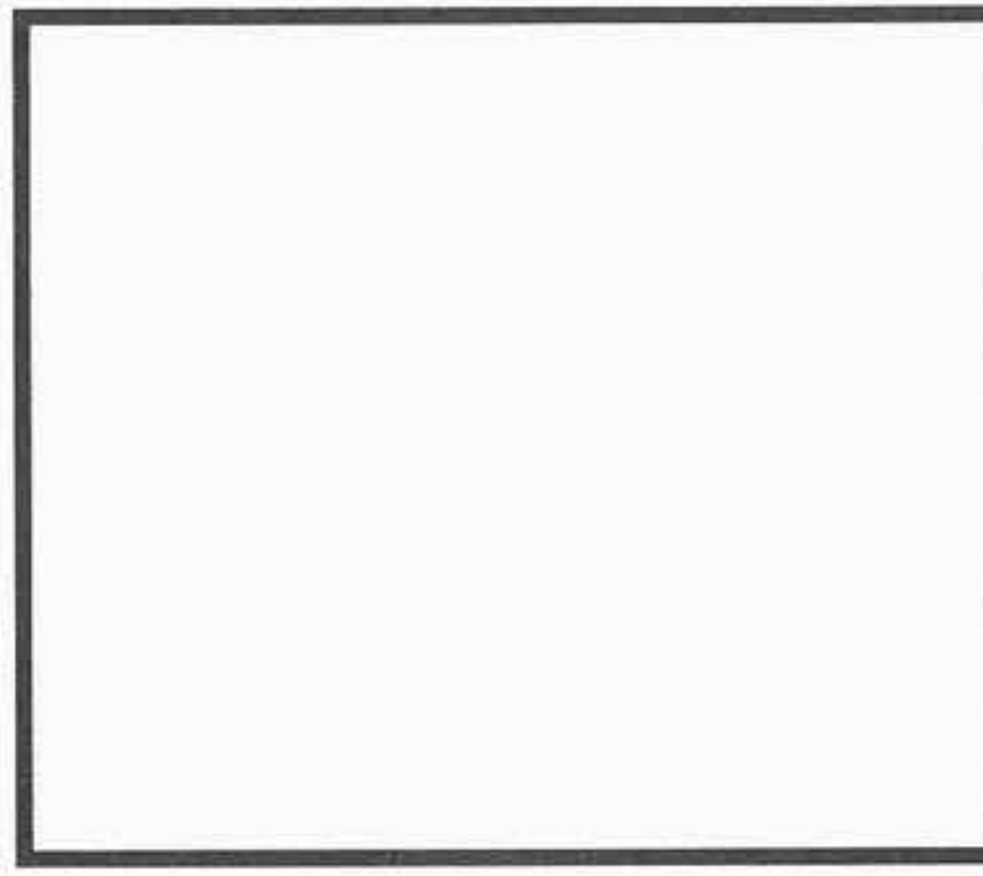
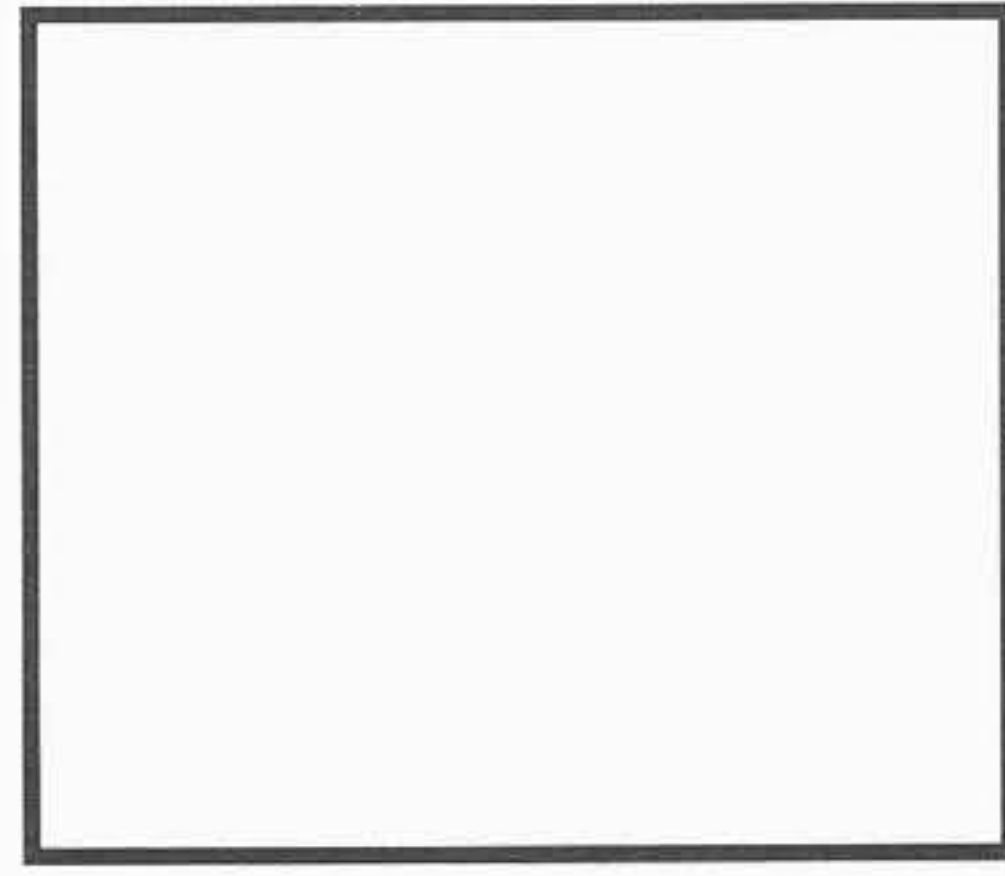

TIPO O MODELLO TYPE OU MODELE TYPE OR MODEL	MOTORE MOTEUR ENGINE	POMPA ACQUA POMPE A EAU WATER PUMP	KIT RIPARAZIONE NECESSAIRE DE REP. REPAIR KIT
<p>tutti i modelli con il motore con aria condizionata</p> <p>all models with engine with air conditioning</p>	<p>MWM D 226.3 D 226.4 D 226.6</p>	<p>283.295 77.00.019.362</p> 	<p>282.282 ---</p> 
			
			
			

I ricambi non sono originali ma adattabili . Ogni riferimento originale é assolutamente indicativo .  
Spare parts are not original but perfectly suitable . Every original part number has to be considered for reference purpose only .



**SECTION 38**

**APPLICATION**

**SAME  
DEUTZ - FAHR  
GROUP**

**S+L+H  
DEUTZ - FAHR**

**WATER PUMPS WASSERPUMPEN  
POMPE A EAU BOMBA DE AGUA**

**S.P. WATER PUMPS LTD**  
18 Tatton Court, Kingsland Grange, Woolston,  
Warrington, Cheshire. ENGLAND. WAI 4RR  
TEL: +44(0) 1925 850082 Fax: +44(0) 1925 850083  
Email:sales@spwaterpumps.co.uk Web Site:www.spwaterpumps.co.uk



SUITABLE



**SAME DEUTZ-FAHR GROUP**

DEUTZ-FAHR

Tel: +44(0)1925 850082 Fax: +(0)44 1925 850083

www.spwaterpumps.co.uk

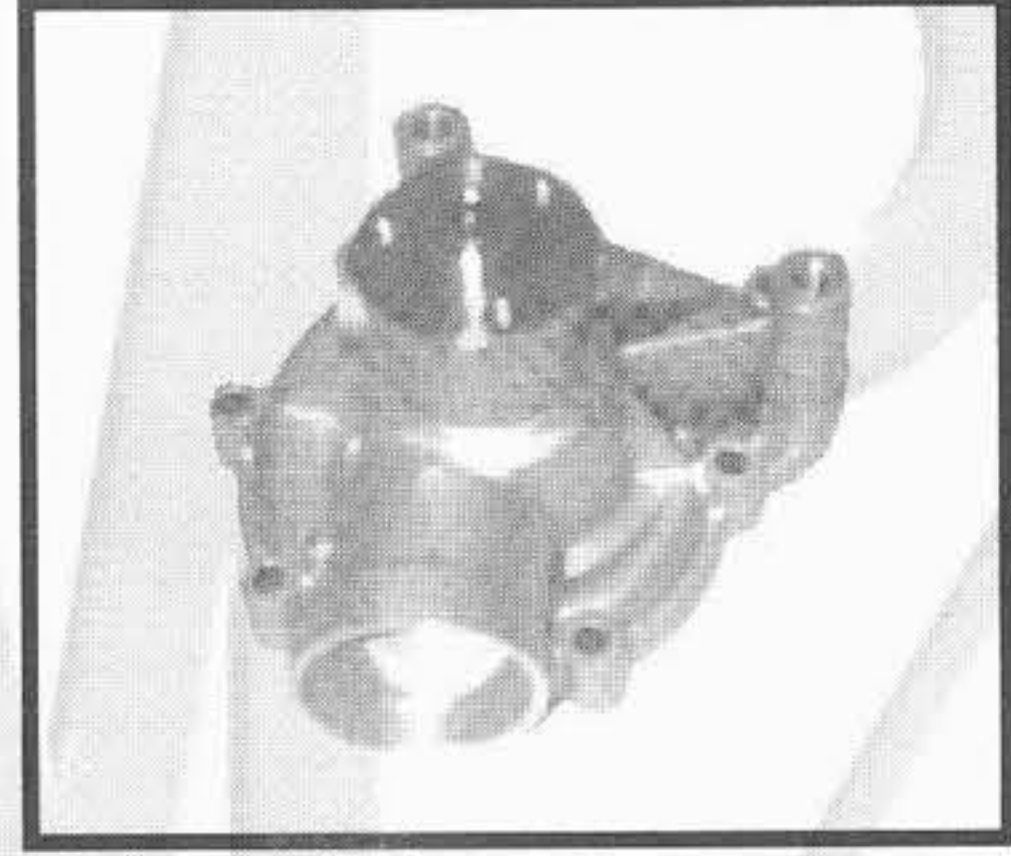
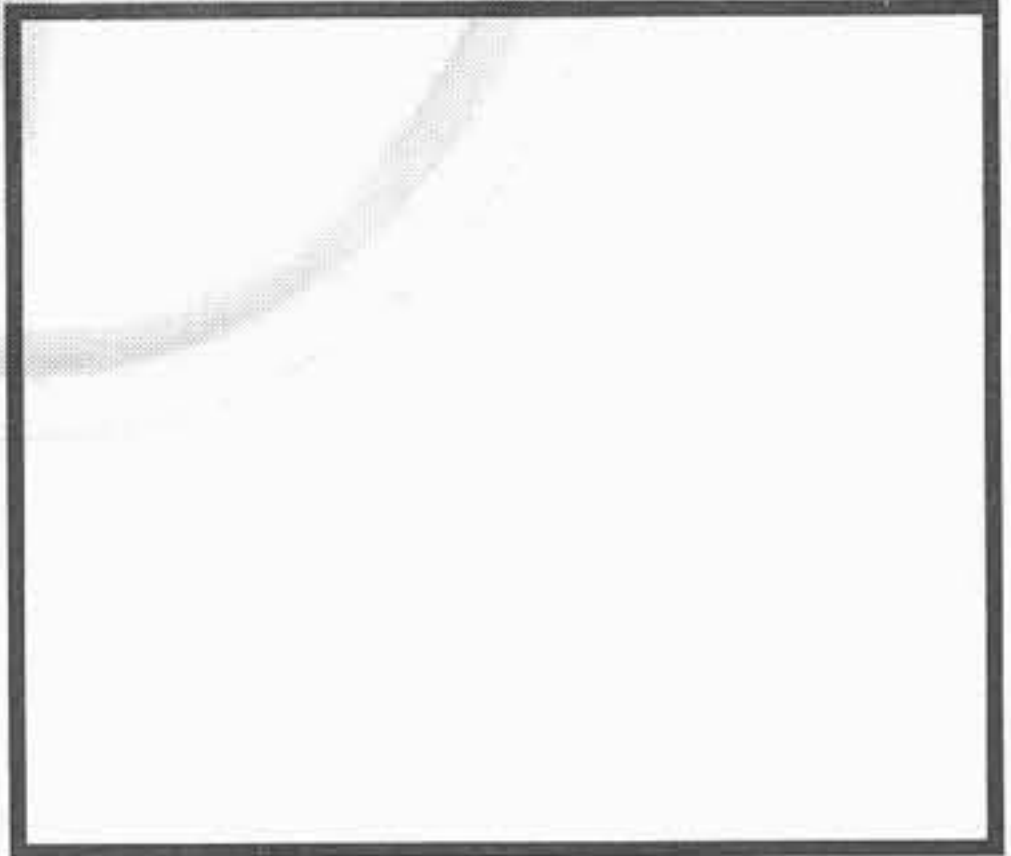

TIPO O MODELLO TYPE OU MODELE TYPE OR MODEL	MOTORE MOTEUR ENGINE	POMPA ACQUA POMPE A EAU WATER PUMP	OMP REF. / O.EM. REF	KIT RIPARAZIONE NECESSAIRE DE REP. REPAIR KIT
<p><b>AGROTRON</b> 4.70 - 4.80 - 4.85 - 4.95</p> <p><b>AGROPLUS</b> 75 - 85 - 95</p> <p><b>AGROTRON</b> 6.01 - 6.05 - 6.15 - 6.30 - 6.45</p> <p><b>AGROPLUS</b> 100</p>	<p>BF4M1012 4 cyl. 3191 cc</p> <p>BF6M1012 6 cyl. 4788 cc</p>	<p><b>363.310</b>      4206172</p> 	<p>OMP REF. / O.EM. REF</p>	<p>KIT RIPARAZIONE NECESSAIRE DE REP. REPAIR KIT</p>
<p><b>AGROTRON</b> 160 - 175 - 200</p>	<p>BF6M1013 6 cyl. 7146 cc</p>	<p><b>363.320</b>      4205959</p> 	<p>OMP REF. / O.EM. REF</p>	<p>KIT RIPARAZIONE NECESSAIRE DE REP. REPAIR KIT</p>
			<p>OMP REF. / O.EM. REF</p>	<p>KIT RIPARAZIONE NECESSAIRE DE REP. REPAIR KIT</p>
			<p>OMP REF. / O.EM. REF</p>	<p>KIT RIPARAZIONE NECESSAIRE DE REP. REPAIR KIT</p>

I ricambi non sono originali ma adattabili . Ogni riferimento originale é assolutamente indicativo .  
Spare parts are not original but perfectly suitable . Every original part number has to be considered for reference purpose only .







SUITABLE

**SAME****DEUTZ - FAHR GROUP**

Tel: +44(0)1925 850082 Fax: +(0)44 1925 850083

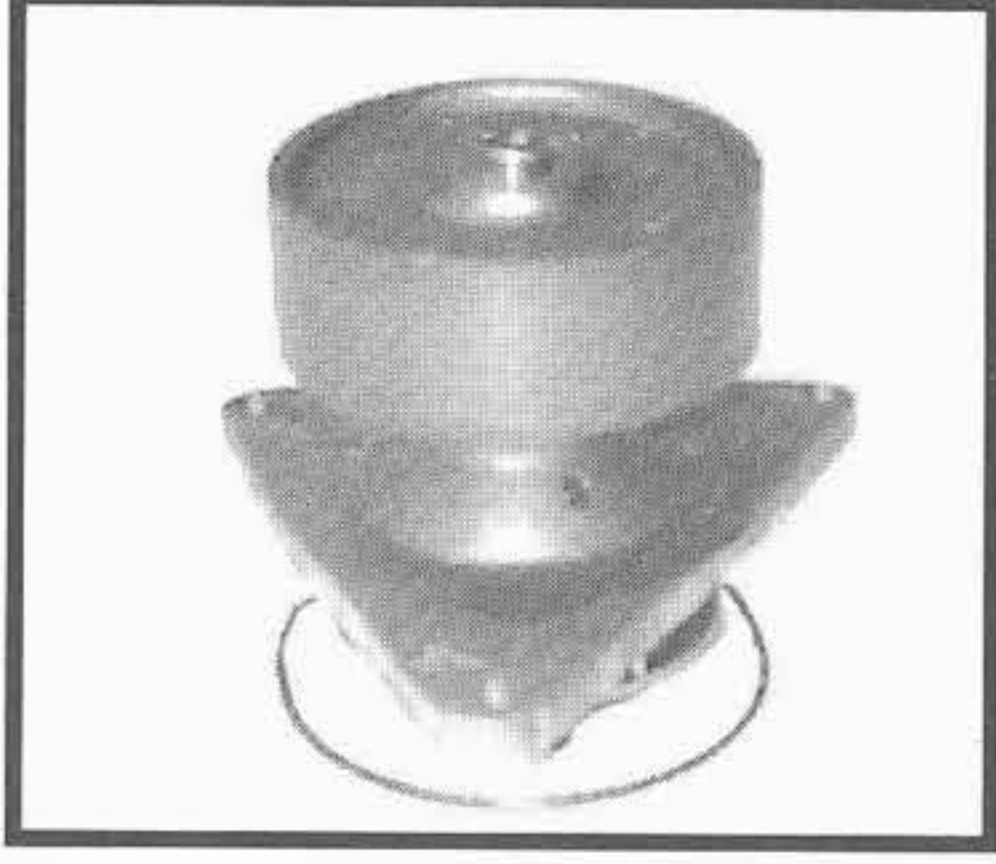
www.spwaterpumps.co.uk

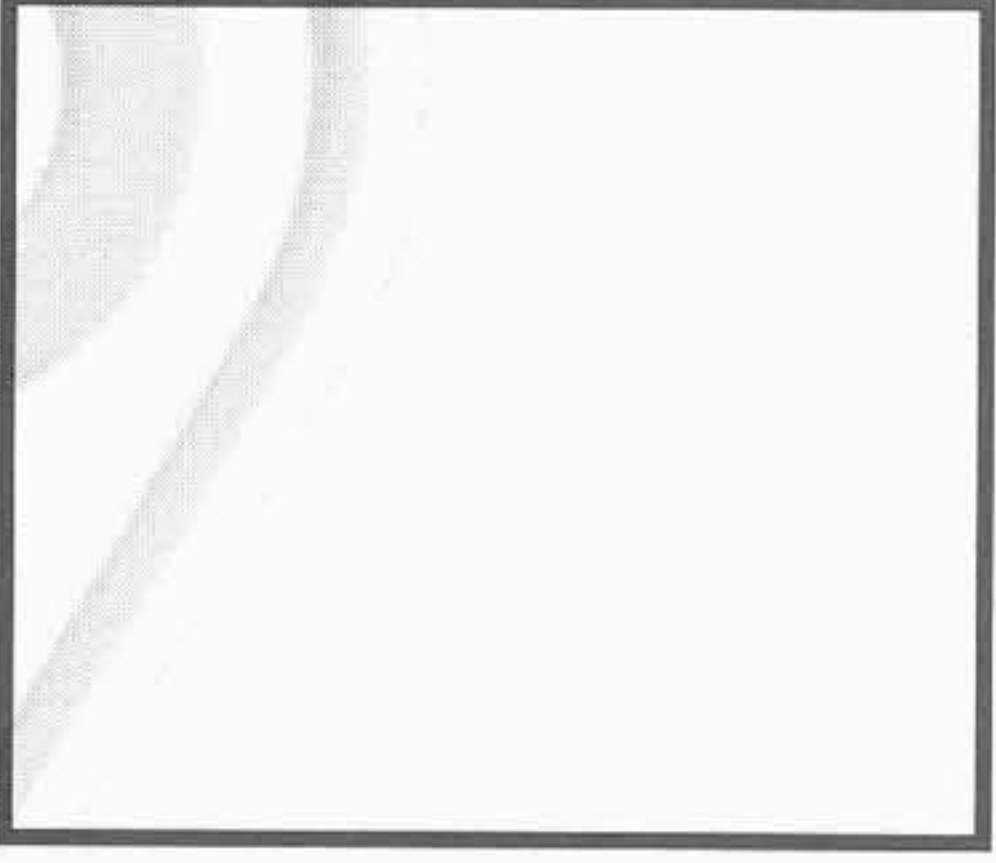

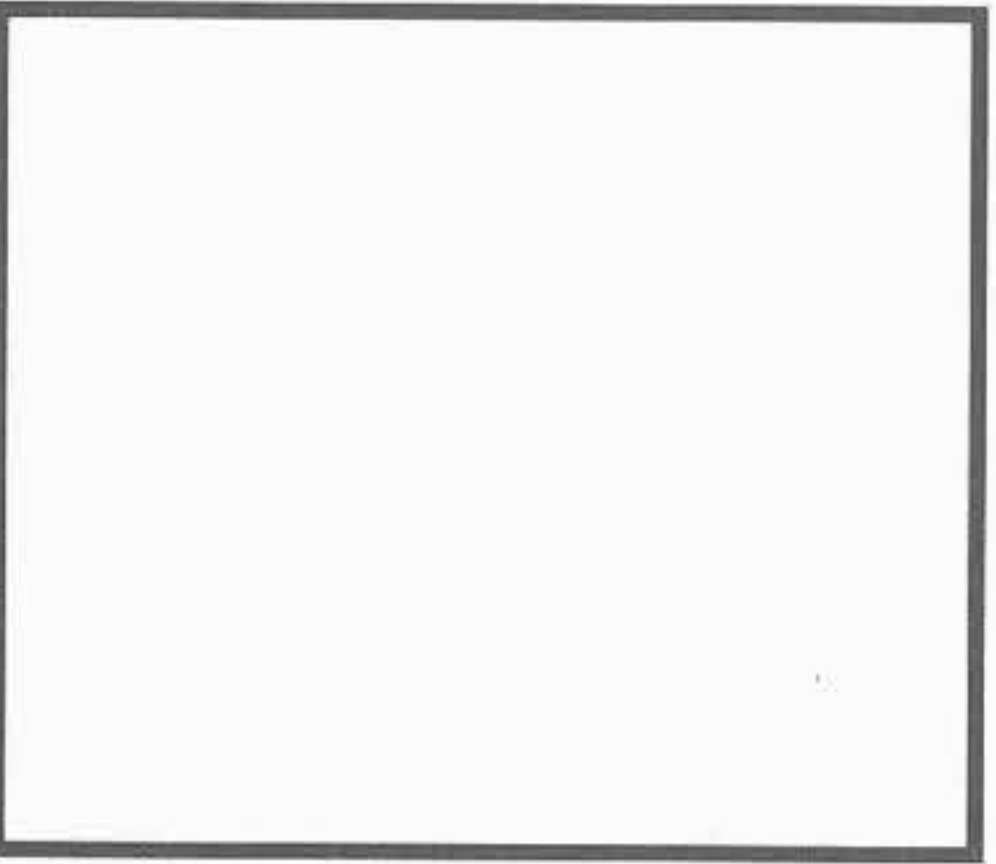
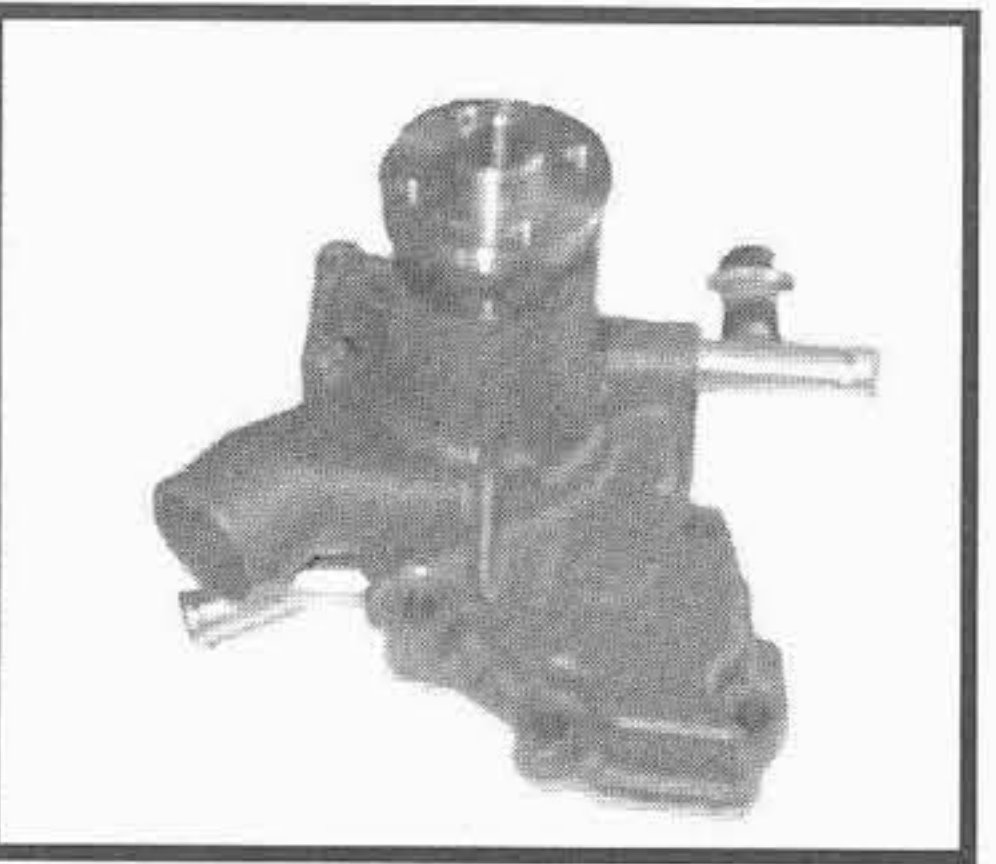
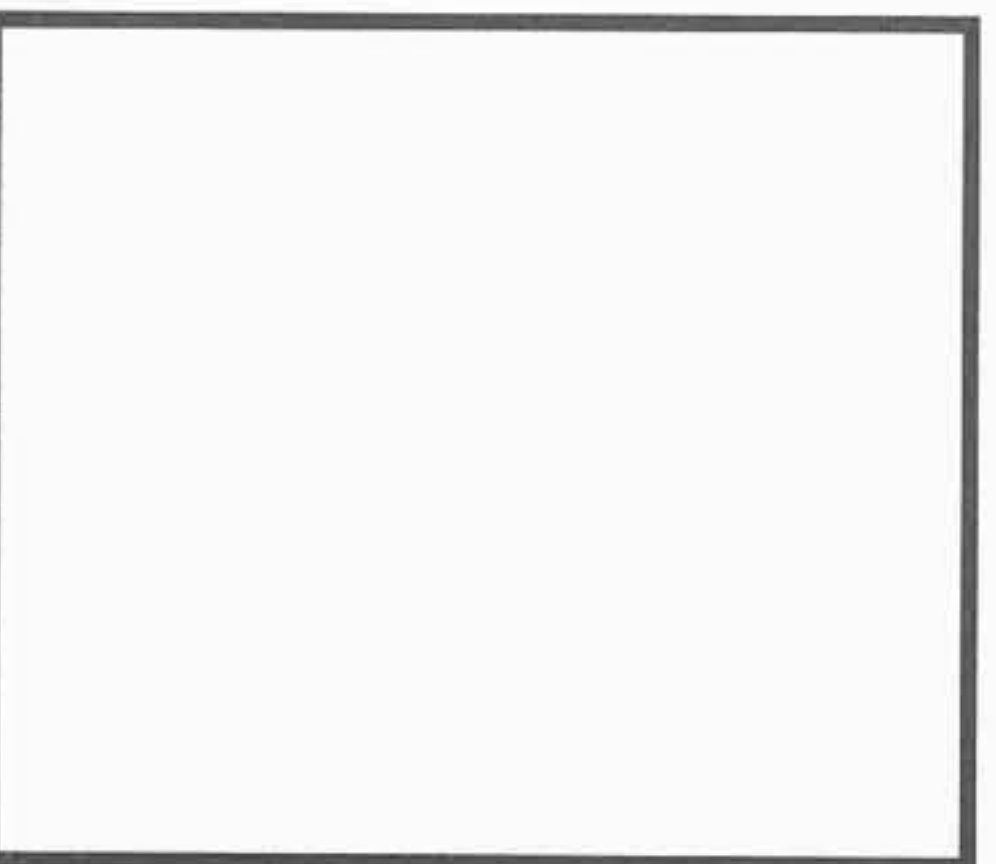
TIPO O MODELLO TYPE OU MODELE TYPE OR MODEL	MOTORE MOTEUR ENGINE	POMPA ACQUA POMPE A EAU WATER PUMP	KIT RIPARAZIONE NECESSAIRE DE REP. REPAIR KIT
<b>SAME</b>  265  <b>LAMBORGHINI</b>  TRACTION 265	<b>CUMMINS</b> 6 CT - 8300 cc	<b>451.025</b> 3913430  	
<b>LAMBORGHINI</b>  674 - 674.70 - 674.70GP 774.5 SPRINT 664-60 - 674-70 774.80 CROSS 574-60 - 674-70 PLUS 660 - 775 - 880 - 990 VIGNETO 660 - 775  <b>HÜRLIMANN</b>  356 - 358	916.3 - 916.4  1000.4	<b>391.000</b> 009.7039.6  	
<b>SAME</b>  SILVER 80 - 90 - 100.4  <b>LAMBORGHINI</b>  774.80 - 774.80GP - 775 874.90 - 874.90GP PREMIUM 850 - 950 - 1050 FORMULA 105  <b>HÜRLIMANN</b>  CLUB H358.4 - H468.4	1000.4  916.4 WT	<b>391.010</b> 082.1740.6  	
<b>LAMBORGHINI</b>  874.90  <b>HÜRLIMANN</b>  488T - XA606 - XA607 XT 908 - XT909 - XT910.4	916.3 - 916.4 con aria condizionata  with air conditionig  1000.4	<b>391.020</b> 082.1756.4  	

I ricambi non sono originali ma adattabili . Ogni riferimento originale é assolutamente indicativo .  
Spare parts are not original but perfectly suitable . Every original part number has to be considered for reference purpose only .

SUITABLE





**SAME**

**DEUTZ-FAHR GROUP**

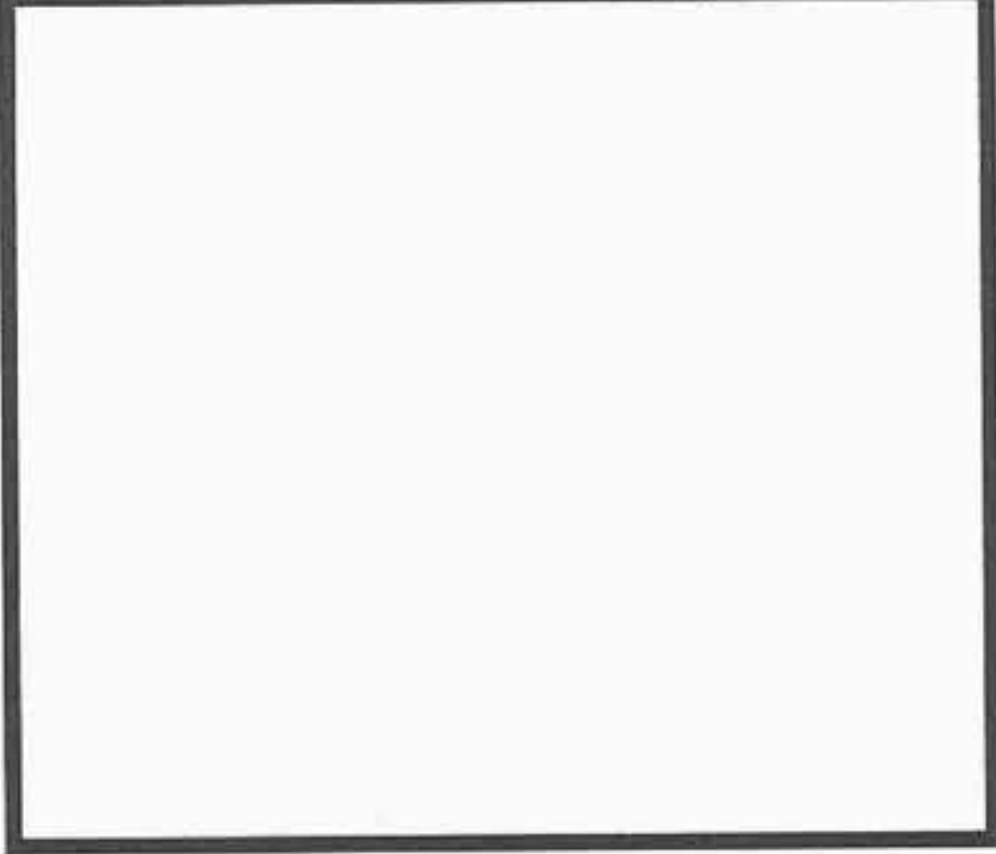
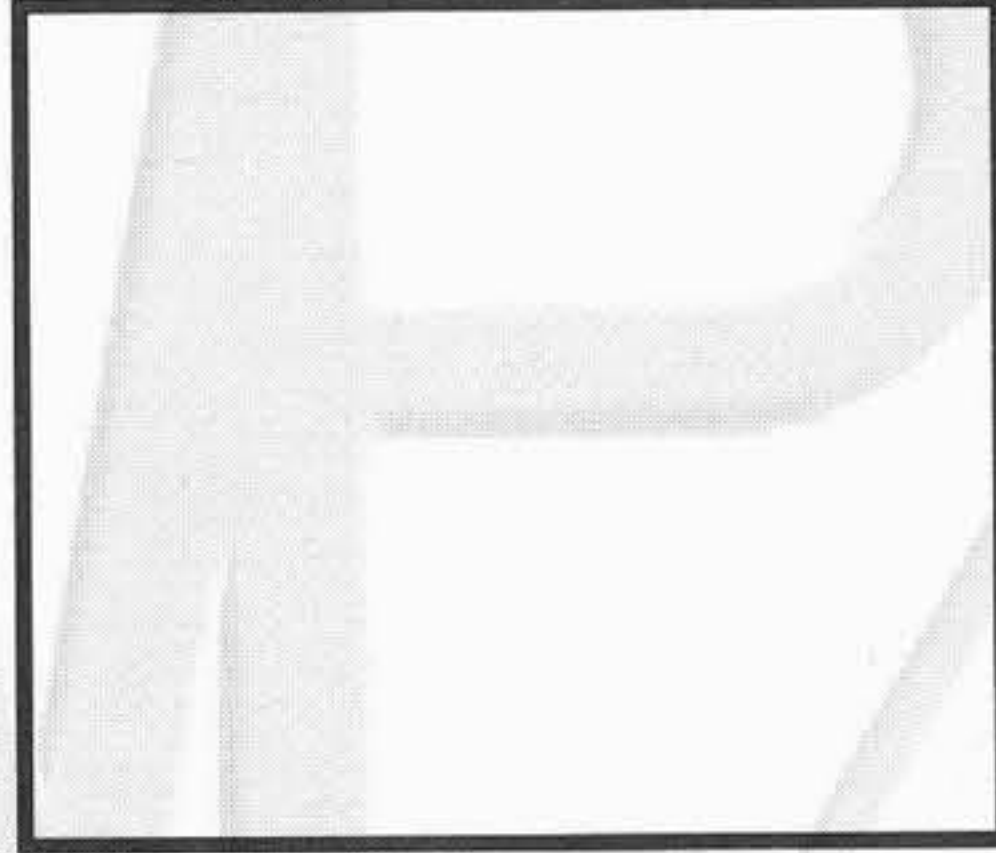
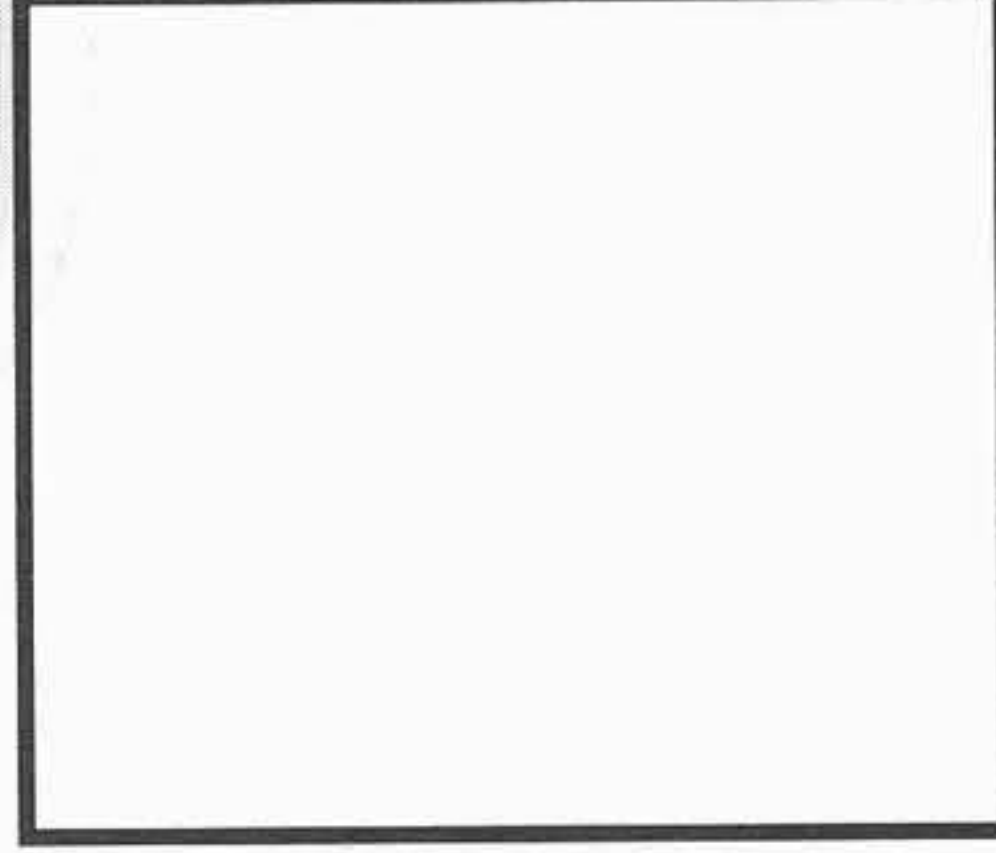
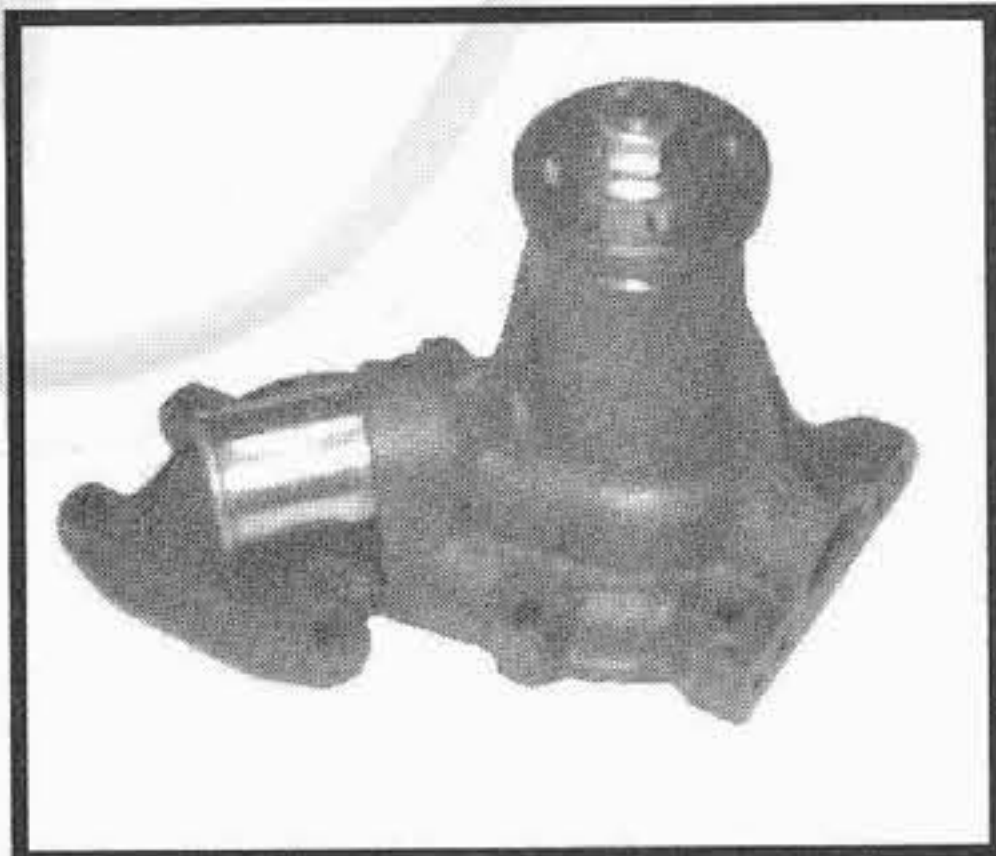

Tel:+44(0)1925 850082 Fax: +(0)44 1925 850083

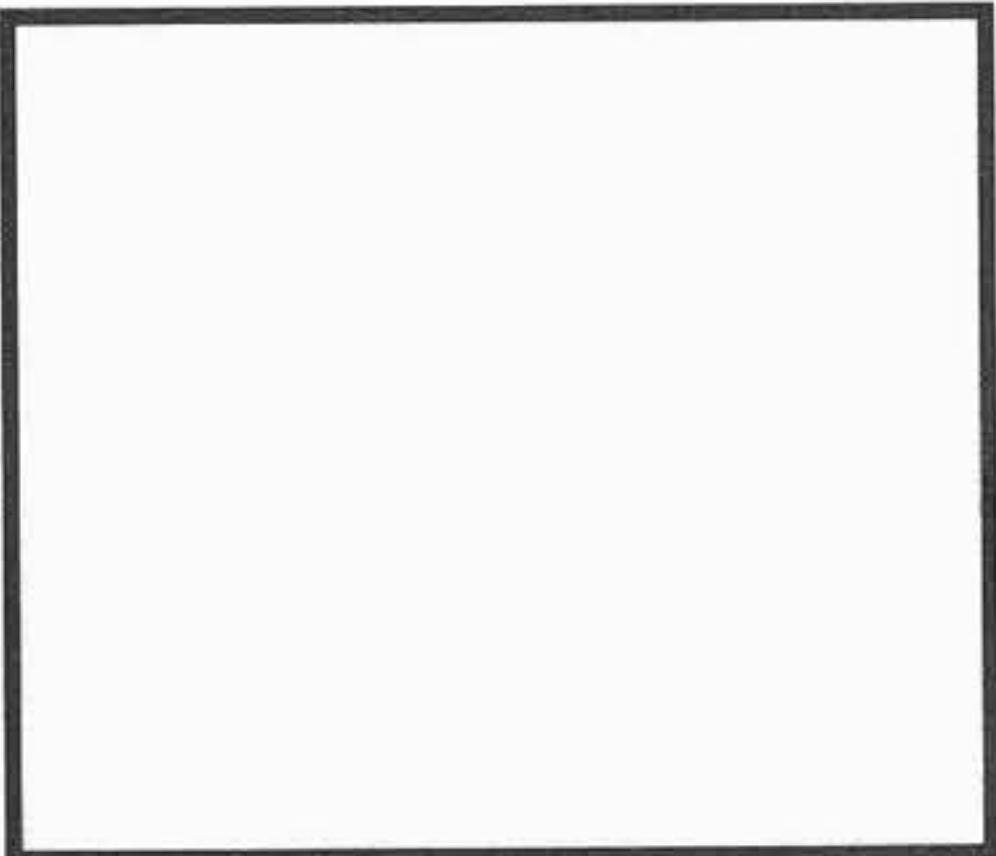
www.spwaterpumps.co.uk

TIPO O MODELLO TYPE OU MODELE TYPE OR MODEL	MOTORE MOTEUR ENGINE	POMPA ACQUA POMPE A EAU WATER PUMP OMP REF. / O.EM. REF	KIT RIPARAZIONE NECESSAIRE DE REP. REPAIR KIT OMP REF. / O.EM. REF
<p><b>SAME</b> SILVER100.6</p> <p><b>LAMBORGHINI</b> 956 - 1306 1060 FORMULA 115 - 135</p> <p><b>HÜRLIMANN</b> ELITE 6115 - 6135 XT 908 - XT909 - XT910.4</p>	<p>1000.6</p> <p>916.6 1000.6</p>	<p><b>391.030</b> 075.1740.4/60</p> 	<p><b>392.001</b></p> 
<p><b>SAME</b> ANTARES II 110 - 130</p> <p><b>LAMBORGHINI</b> 1106 - 1306</p> <p><b>HÜRLIMANN</b> XT 910.6</p>	<p>1000.6</p> <p>916.6</p>	<p><b>391.040</b> 078.1740.4/60</p> 	<p><b>392.001</b></p> 
<p><b>SAME</b> TITAN 145 - 160 - 190</p> <p><b>LAMBORGHINI</b> 1106 - 1306 RACING 150 - 165 - 190</p> <p><b>HÜRLIMANN</b> 1356 - 1556 - 1506 - 1706 H-6165 - H6190</p>	<p>1000.6</p> <p>1000.6</p>	<p><b>391.050</b> 064.1740.6/20</p> 	<p><b>392.002</b></p> 
			

I ricambi non sono originali ma adattabili . Ogni riferimento originale é assolutamente indicativo .  
Spare parts are not original but perfectly suitable . Every original part number has to be considered for reference purpose only .



**SECTION 39**





**APPLICATION**

**STEYR**

**TRUCKS**

**WATER PUMPS WASSERPUMPEN  
POMPE A EAU BOMBA DE AGUA**

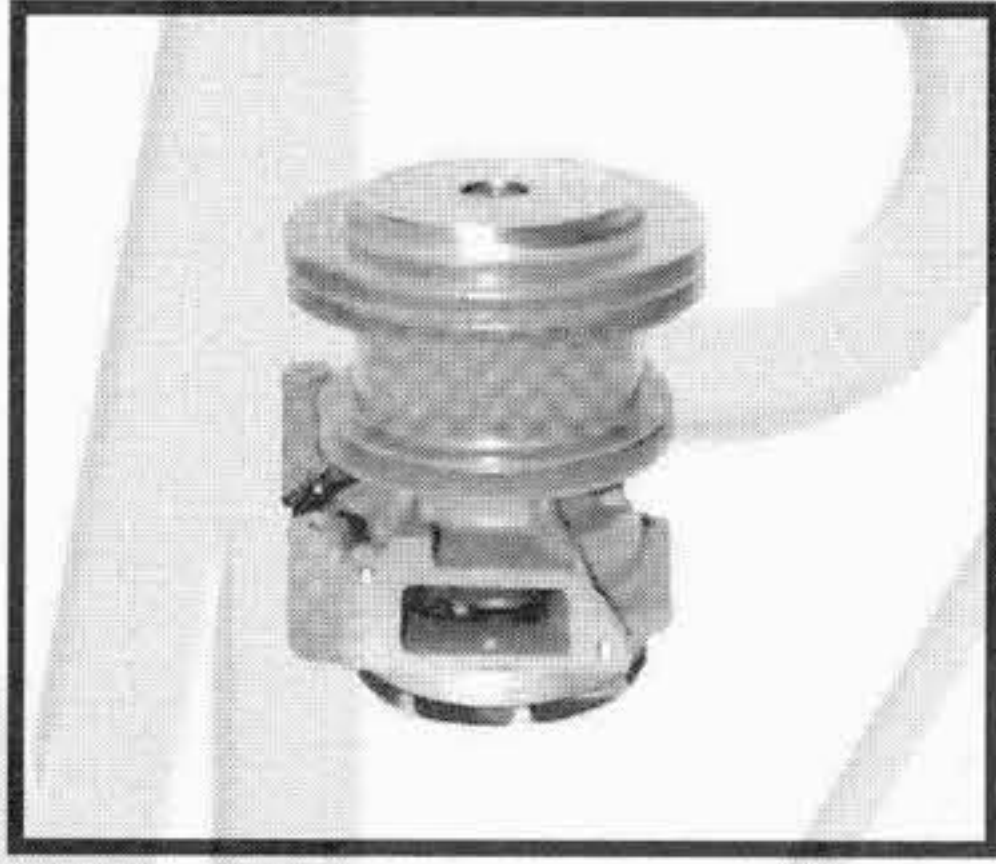
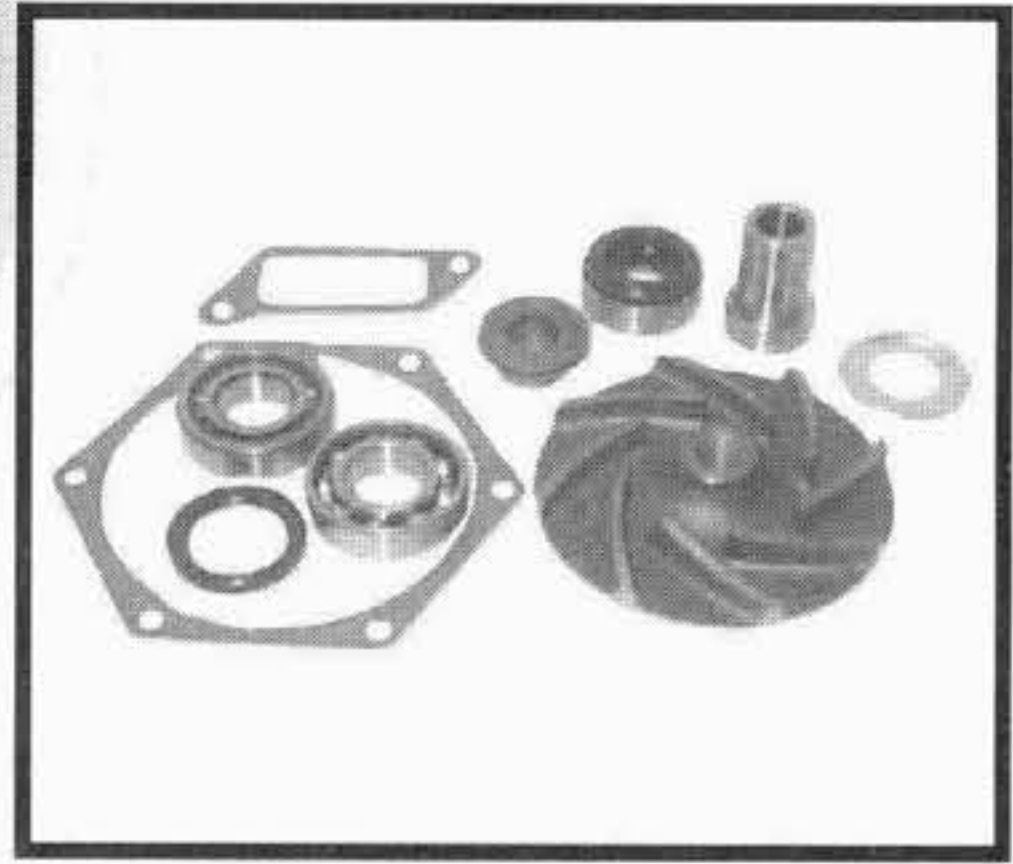
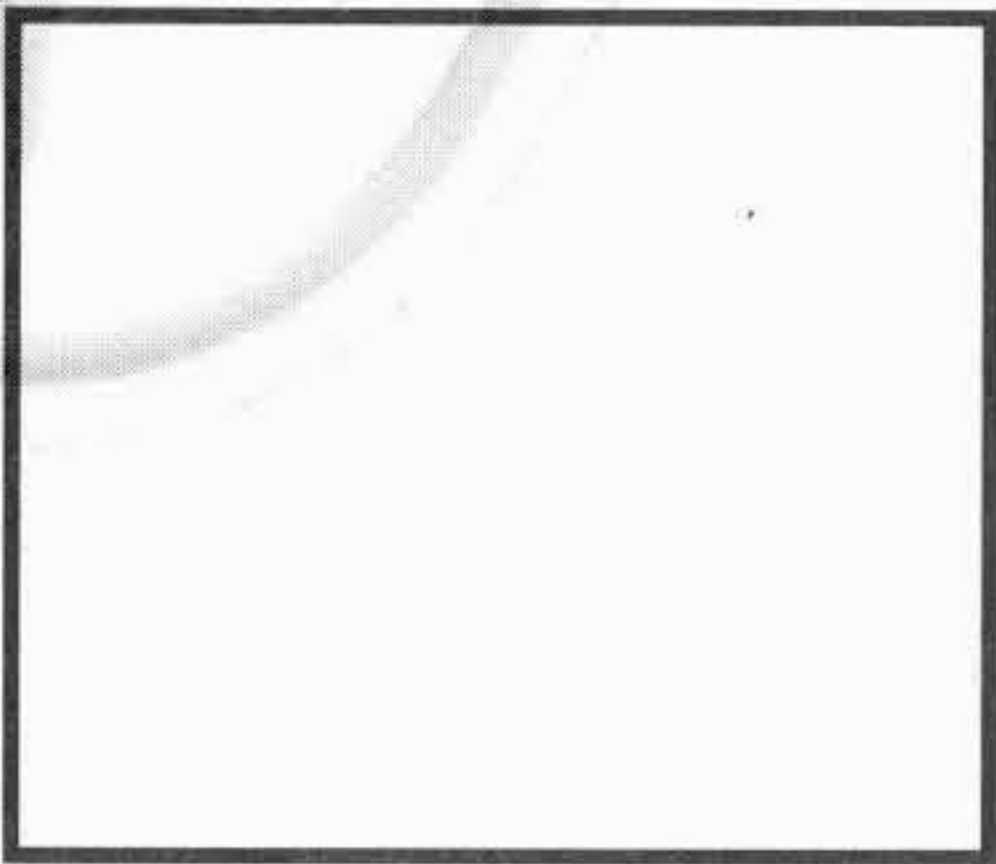
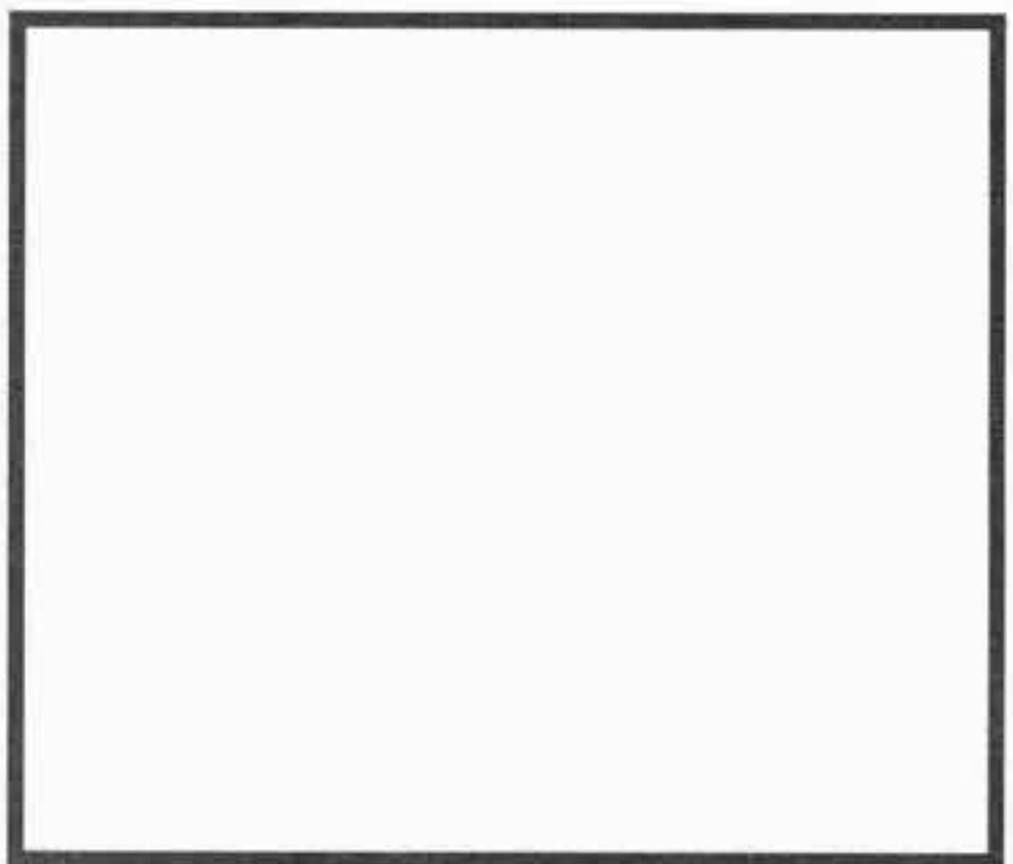
**S.P. WATER PUMPS LTD**  
18 Tatton Court, Kingsland Grange, Woolston,  
Warrington, Cheshire. ENGLAND. WAI 4RR  
TEL: +44(0) 1925 850082 Fax: +44(0) 1925 850083  
Email:sales@spwaterpumps.co.uk Web Site:www.spwaterpumps.co.uk

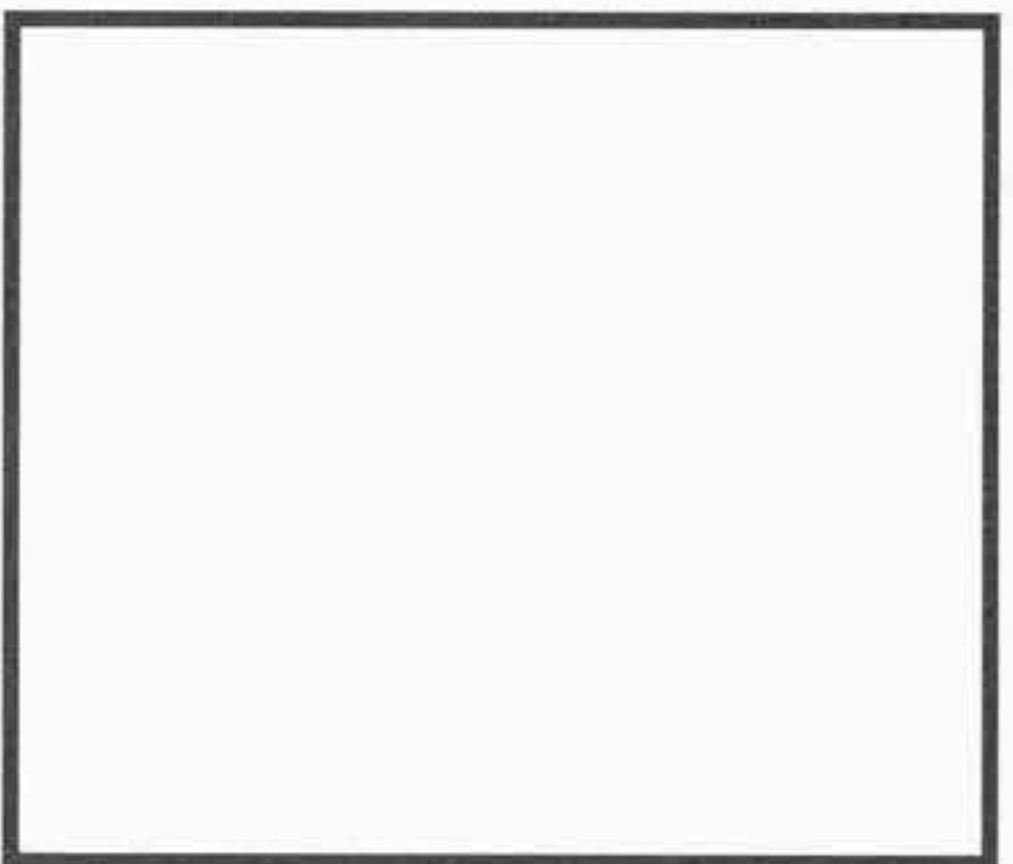
TIPO O MODELLO TYPE OU MODELE TYPE OR MODEL	MOTORE MOTEUR ENGINE	POMPA ACQUA POMPE A EAU WATER PUMP REF. / O.EM. REF	KIT RIPARAZIONE NECESSAIRE DE REP. REPAIR KIT REF. / O.EM. REF
991  1291  1490  1491	WD 615.67	<b>400.000</b> 615.000.60033  	<b>402.000</b> 615.000.60601    --- 615.000.60602 senza girante / without impeller
1291	WD 615.	<b>400.010</b> 615.000.60050  	<b>402.000</b> 615.000.60601    --- 615.000.60602 senza girante / without impeller
			
			

I ricambi non sono originali ma adattabili . Ogni riferimento originale é assolutamente indicativo .  
 Spare parts are not original but perfectly suitable . Every original part number has to be considered for reference purpose only .



**SECTION 39/2**

**APPLICATION**

**STEYR**

**TRACTORS**

**WATER PUMPS WASSERPUMPEN  
POMPE A EAU BOMBA DE AGUA**

**S.P. WATER PUMPS LTD**  
18 Tatton Court, Kingsland Grange, Woolston,  
Warrington, Cheshire. ENGLAND. WAI 4RR  
TEL: +44(0) 1925 850082 Fax: +44(0) 1925 850083  
Email:sales@spwaterpumps.co.uk Web Site:www.spwaterpumps.co.uk

SUITABLE

# STEYR

TRACTORS

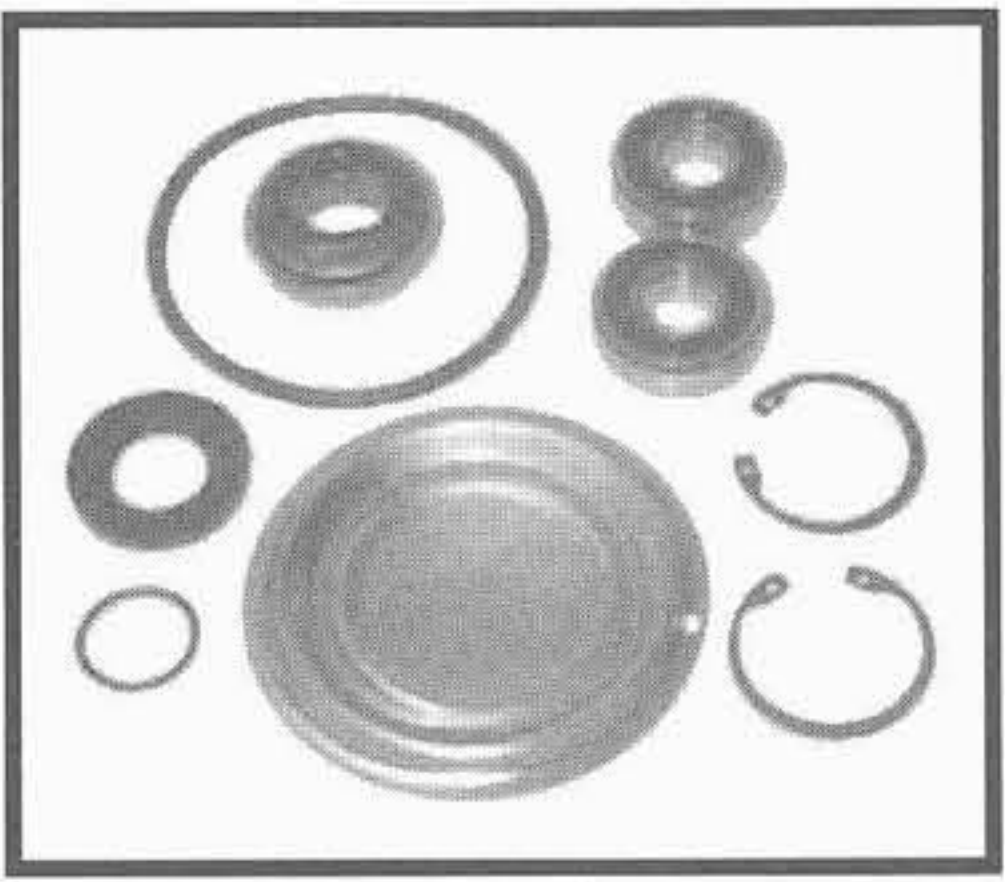
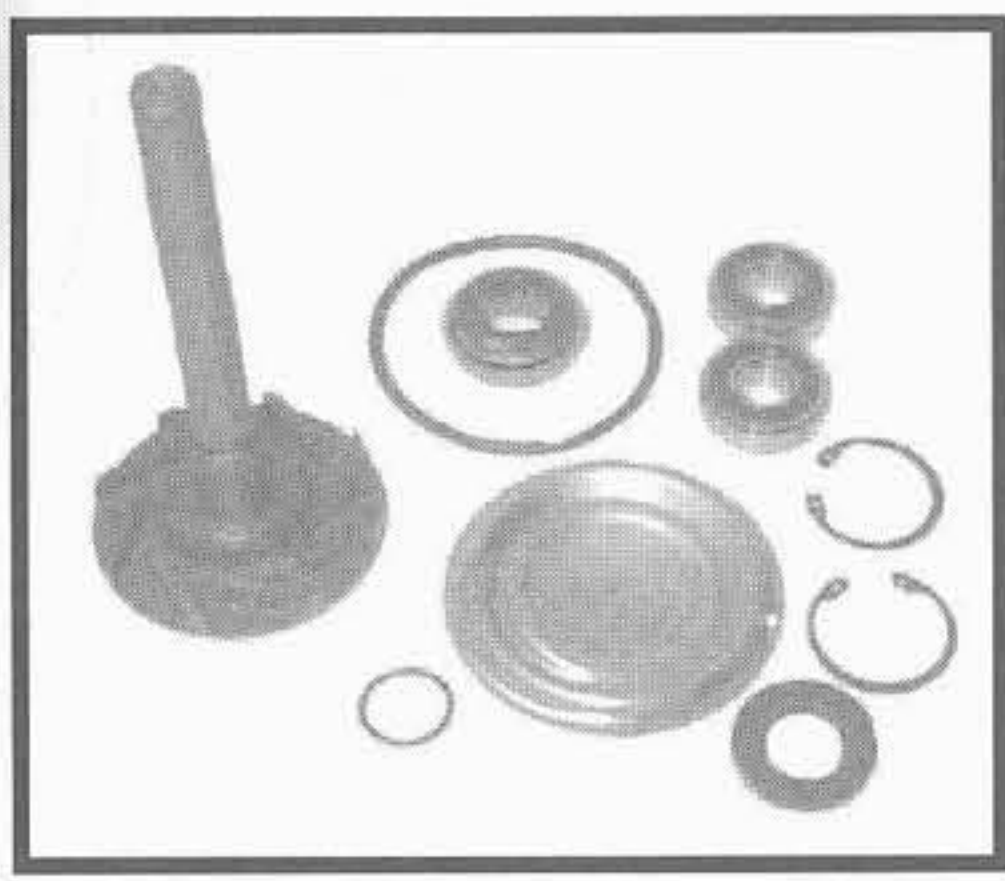
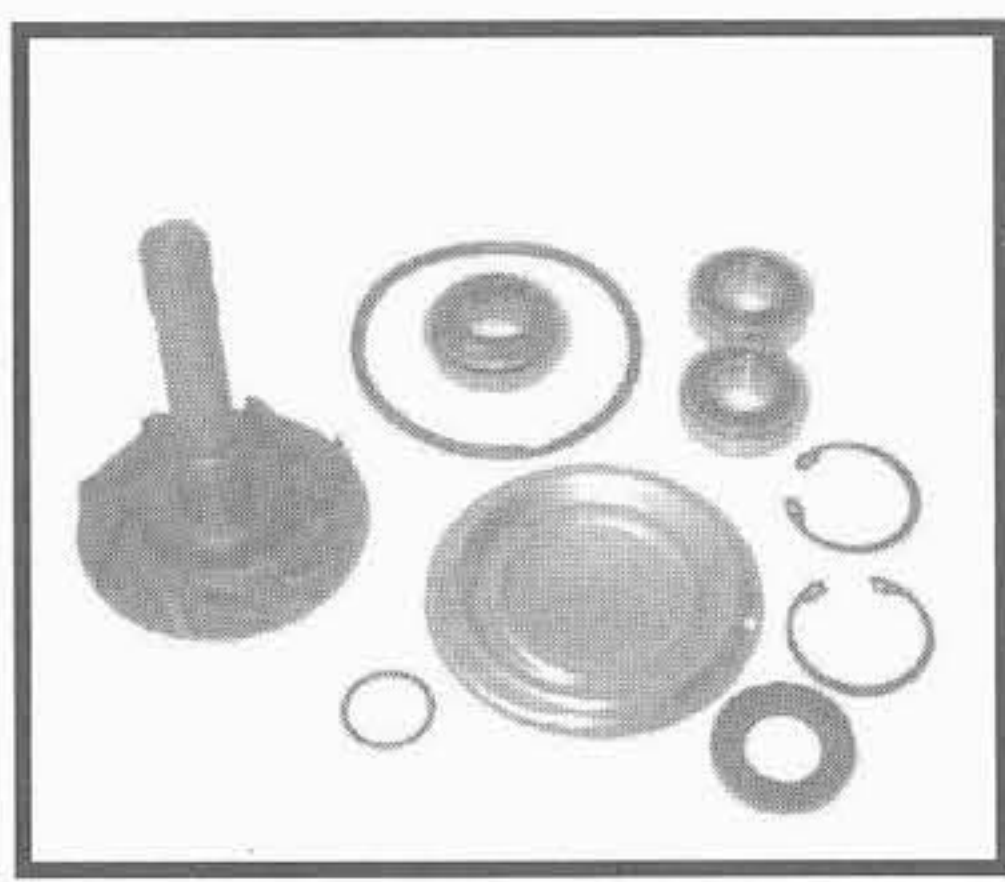
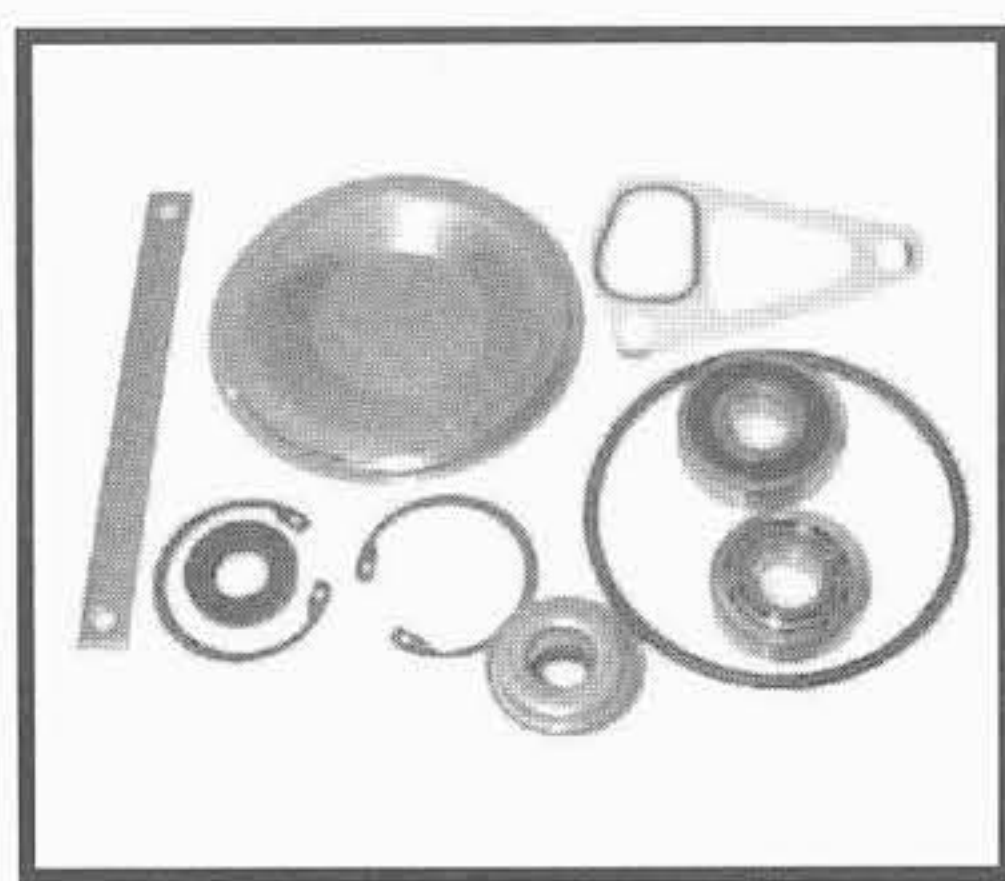

TIPO O MODELLO TYPE OU MODELE TYPE OR MODEL	MOTORE MOTEUR ENGINE	POMPA ACQUA POMPE A EAU WATER PUMP OMP REF. / O.EM. REF	KIT RIPARAZIONE NECESSAIRE DE REP. REPAIR KIT OMP REF. / O.EM. REF
<p>STEYR PLUS</p> <p><b>SERIE 40 :</b> 540 - 545 - 548</p> <p><b>SERIE 50 :</b> 650 - 658</p> <p><b>SERIE 60 :</b> 760 - 768</p> <p>JUBI SERIE 288 - 190 870 - 1100</p>		<div style="border: 1px solid black; padding: 10px; text-align: center;"> <p>non disponibile / not available</p> </div> <p><b>NOTE : senza albero / without shaft</b></p>	<p><b>402.285</b>      407.06.0700</p> <div style="border: 1px solid black; padding: 5px;">  </div>
<p>STEYR PLUS</p> <p><b>SERIE 40 :</b> 540 - 545 - 548</p> <p><b>SERIE 50 :</b> 650 - 658</p> <p><b>SERIE 60 :</b> 760 - 768</p>		<div style="border: 1px solid black; padding: 10px; text-align: center;"> <p>non disponibile / not available</p> </div> <p><b>NOTE : con albero / with shaft L = mm 195</b></p>	<p><b>402.283</b>      407.06.0602</p> <div style="border: 1px solid black; padding: 5px;">  </div>
<p>JUBI SERIE 288 - 190</p>		<div style="border: 1px solid black; padding: 10px; text-align: center;"> <p>non disponibile / not available</p> </div> <p><b>NOTE : con albero / with shaft L = mm 143</b></p>	<p><b>402.287</b></p> <div style="border: 1px solid black; padding: 5px;">  </div>
<p>SERIE 80 SK1 cab. ---&gt; 1985 8060 - 8090</p>		<div style="border: 1px solid black; padding: 10px; text-align: center;"> <p>non disponibile / not available</p> </div>	<p><b>402.284</b>      411.00.06.0700</p> <div style="border: 1px solid black; padding: 5px;">  </div>

I ricambi non sono originali ma adattabili . Ogni riferimento originale é assolutamente indicativo .  
Spare parts are not original but perfectly suitable . Every original part number has to be considered for reference purpose only .

SUITABLE

# STEYR

## TRACTORS



TIPO O MODELLO TYPE OU MODELE TYPE OR MODEL	MOTORE MOTEUR ENGINE	POMPA ACQUA POMPE A EAU WATER PUMP  OMP REF. / O.EM. REF	KIT RIPARAZIONE NECESSAIRE DE REP. REPAIR KIT  OMP REF. / O.EM. REF
SERIE 80 SK2 cab.  1985 --->  8060 - 8090		<div data-bbox="904 563 1367 961" style="border: 1px solid black; padding: 10px; text-align: center;">non disponibile / not available</div>	<div data-bbox="1461 477 1964 531" style="text-align: right;"><b>402.286</b> 311.00.06.0701</div> <div data-bbox="1461 563 1934 961" style="border: 1px solid black; padding: 5px;"></div>
		<div data-bbox="904 1214 1367 1613" style="border: 1px solid black; width: 100%; height: 100%;"></div>	<div data-bbox="1461 1214 1934 1613" style="border: 1px solid black; width: 100%; height: 100%;"></div>
		<div data-bbox="904 1869 1367 2268" style="border: 1px solid black; width: 100%; height: 100%;"></div>	<div data-bbox="1461 1869 1934 2268" style="border: 1px solid black; width: 100%; height: 100%;"></div>
		<div data-bbox="904 2518 1367 2917" style="border: 1px solid black; width: 100%; height: 100%;"></div>	<div data-bbox="1461 2518 1934 2917" style="border: 1px solid black; width: 100%; height: 100%;"></div>

I ricambi non sono originali ma adattabili . Ogni riferimento originale é assolutamente indicativo .  
Spare parts are not original but perfectly suitable . Every original part number has to be considered for reference purpose only .



**SECTION 3312**

**APPLICATION**

**UNIMOG**

**MB TRAC**

**MERCEDES BENZ**

**WATER PUMPS WASSERPUMPEN**  
**POMPE A EAU BOMBA DE AGUA**  
**POMPA ACQUA**

**S.P. WATER PUMPS LTD**  
18 Tatton Court, Kingsland Grange, Woolston,  
Warrington, Cheshire. ENGLAND. WAI 4RR  
TEL: +44(0) 1925 850082 Fax: +44(0) 1925 850083  
Email:sales@spwaterpumps.co.uk Web Site:www.spwaterpumps.co.uk



TAVOLE DI CONVERSIONE  
TABLE DE CONVERSION  
CONVERSION TABLE

UNIMOG - MB TRAC MERCEDES BENZ



NUMERO ORIGINALE NUMERO ORIGINAL ORIGINAL NUMBER	NUMERO SOSTITUTIVO REPLACE PAR NUMERO REPLACED BY NUMBER	RIFERIMENTO OMP REFERENCE OMP OMP REFERENCE
000.201.00.63		241.805
000.201.01.97	VEDI 241.805	241.853
000.201.04.63	VEDI 241.805	244.004
000.201.27.19		241.784
000.201.32.19	000.201.37.19	
000.201.37.19	000.201.61.19	
000.201.57.19	000.201.67.19	
000.201.61.19	000.201.66.19	
000.201.65.19	000.201.68.19	
000.201.66.19	000.201.72.19	
000.201.67.19	000.201.72.19	
000.201.68.19	000.201.69.19	
000.201.69.19	000.201.71.19	
000.201.71.19	000.201.73.19	
000.201.72.19		241.815
000.201.73.19	000.201.80.19	
000.201.80.19		241.857
000.997.19.88		241.774
000.997.75.47		241.770
000.997.77.47		241.769
001.981.96.01		241.810
002.997.84.46	=005.997.01.47	241.812
003.997.51.46	=005.997.00.47	241.811
003.997.57.48		241.798
005.997.00.47	=003.997.51.46	241.811
005.997.01.47	=002.997.84.46	241.812
005.997.11.45		241.813
011.997.70.48		241.912
304.357.01.21		241.838
314.200.00.07	364.200.06.04	241.934
314.200.00.60	314.200.40.01	
314.200.01.04	314.200.06.04	
314.200.01.60		242.222
314.200.03.04	314.200.04.04	
314.200.04.04	314.200.07.04	
314.200.05.04	314.200.08.04	
314.200.06.01	314.200.08.01	
314.200.06.04	314.200.09.04	
314.200.07.04	314.200.10.04	
314.200.08.01	314.200.19.01	
314.200.08.04	314.200.11.04	
314.200.09.04		242.223
314.200.10.04		242.224
314.200.11.04		242.225
314.200.19.01	314.200.21.01	
314.200.21.01	314.200.24.01	
314.200.24.01	314.200.29.01	

NUMERO ORIGINALE NUMERO ORIGINAL ORIGINAL NUMBER	NUMERO SOSTITUTIVO REPLACE PAR NUMERO REPLACED BY NUMBER	RIFERIMENTO OMP REFERENCE OMP OMP REFERENCE
314.200.29.01	314.200.37.01	
314.200.35.01	314.200.41.01	
314.200.37.01	314.200.39.01	
314.200.39.01	314.200.42.01	
314.200.40.01		242.202
314.200.41.01	314.200.47.01	
314.200.42.01		241.900
314.200.47.01		241.930
314.201.05.01		241.931
314.586.00.20	314.200.00.60	
314.586.01.20	314.200.01.04	
315.201.01.02		241.762
315.201.01.51		241.766
315.201.01.80		241.775
315.201.02.05		241.764
315.201.03.03		241.782
315.202.00.08		241.763
321.200.04.01	352.200.23.01	
322.200.02.03	352.200.15.01	
322.200.08.01	352.200.23.01	
327.201.01.05		241.737
327.201.07.80		241.899
327.203.01.80		241.742
327.203.03.80	352.203.04.80	
352.200.02.60	352.200.05.60	
352.200.04.60	353.200.30.01	
352.200.05.60	353.200.31.01	
352.200.06.04	352.200.08.04	
352.200.06.60	353.200.25.01	
352.200.07.04	352.200.08.04	
352.200.08.04	352.200.09.04	
352.200.08.60	353.200.24.01	
352.200.09.04	352.200.10.04	
352.200.09.60		242.227
352.200.10.04	352.200.19.04	
352.200.10.60	353.200.26.01	
352.200.13.04	352.200.28.04	
352.200.14.04	352.200.29.04	
352.200.15.01	352.200.20.01	
352.200.15.04	352.200.30.04	
352.200.16.04	352.200.31.04	
352.200.17.04	352.200.32.04	
352.200.19.04	352.200.33.04	
352.200.20.01	352.200.23.01	
352.200.23.01	352.200.93.01	
352.200.23.04	352.200.34.04	
352.200.24.04	352.200.35.04	

OGNI RIFERIMENTO ORIGINALE E' ASSOLUTAMENTE INDICATIVO. CHAQUE REFERENCE ORIGINAL EST ABSOLUMENT INDICATIVE. EVERY ORIGINAL PART NUMBER HAS TO BE CONSIDERED FOR REFERENCE PURPOSE ONLY.

TAVOLE DI CONVERSIONE  
TABLE DE CONVERSION  
CONVERSION TABLE

UNIMOG - MB TRAC

MERCEDES BENZ



NUMERO ORIGINALE NUMERO ORIGINAL ORIGINAL NUMBER	NUMERO SOSTITUTIVO REPLACE PAR NUMERO REPLACED BY NUMBER	RIFERIMENTO OMP REFERENCE OMP OMP REFERENCE
352.200.25.04	352.200.36.04	
352.200.28.04	352.200.38.04	
352.200.29.04	352.200.39.04	
352.200.30.04	352.200.40.04	
352.200.31.04	352.200.41.04	
352.200.32.04	352.200.42.04	
352.200.33.04	352.200.43.04	
352.200.34.01	352.200.54.01	
352.200.34.04	352.200.44.04	
352.200.35.04	352.200.45.04	
352.200.36.04	352.200.46.04	
352.200.38.01	352.200.94.01	
352.200.38.04		242.191
352.200.39.01	352.200.94.01	
352.200.39.04		242.205
352.200.40.04		242.164
352.200.41.04		242.215
352.200.42.04		242.146
352.200.43.04		242.228
352.200.44.04		242.229
352.200.45.04		242.230
352.200.46.04		
352.200.49.01	352.200.84.01	
352.200.54.01	352.200.95.01	
352.200.72.01	352.200.85.01	
352.200.74.01	352.200.84.01	
352.200.75.01	352.200.85.01	
352.200.81.01	352.200.95.01	
352.200.84.01	353.200.04.01	
352.200.85.01	352.200.92.01	
352.200.86.01	353.200.19.01	
352.200.87.01	353.200.15.01	
352.200.89.01	352.200.96.01	
352.200.92.01	352.200.97.01	
352.200.93.01	353.200.40.01	
352.200.94.01	353.200.03.01	
352.200.95.01	352.200.96.01	
352.200.96.01	353.200.16.01	
352.200.97.01	353.200.17.01	
352.201.00.12		241.797
352.201.00.39		241.792
352.201.00.58	352.201.02.58	
352.201.01.05		241.802
352.201.01.07		241.793
352.201.02.01		241.777
352.201.02.58	352.201.05.58	
352.201.03.01		241.747

NUMERO ORIGINALE NUMERO ORIGINAL ORIGINAL NUMBER	NUMERO SOSTITUTIVO REPLACE PAR NUMERO REPLACED BY NUMBER	RIFERIMENTO OMP REFERENCE OMP OMP REFERENCE
352.201.04.80		241.778
352.201.05.07	366.200.02.04	241.847
352.201.05.58		241.848
352.201.05.80		241.789
352.201.06.01		241.744
352.201.06.05		241.746
352.201.06.80		241.897
352.201.08.03	352.201.09.03	
352.201.08.80		241.854
352.201.09.03		241.779
352.201.10.01		241.843
352.201.10.80		241.898
352.201.11.80	352.201.12.80	
352.201.12.80		241.851
352.201.13.03	352.201.18.03	
352.201.14.03		
352.201.15.03		241.748
352.201.16.03		241.844
352.201.17.01		241.756
352.201.17.03		241.757
352.201.18.03		241.937
352.201.19.01		241.936
352.201.19.03		241.942
352.201.20.03		241.939
352.201.21.01		241.941
352.201.22.01		241.938
352.203.04.80		241.796
352.203.07.80	352.203.16.80	
352.203.16.80		241.909
352.586.00.20	353.200.42.01	
352.586.02.20	352.200.04.60	
352.586.03.20	352.200.02.60	
352.586.04.20	352.586.05.20	
352.586.05.20	352.200.02.60	
352.586.06.20	352.200.13.04	
352.586.07.20	352.200.14.04	
352.586.08.20	353.200.00.04	
352.586.10.20	352.200.06.60	
352.586.11.20	352.200.15.04	
352.586.12.20	352.200.16.04	
352.586.15.20	352.200.17.04	
353.200.02.01	353.200.05.01	
353.200.03.01	353.200.21.01	
353.200.04.01	353.200.36.01	
353.200.05.01	353.200.20.01	
353.200.15.01	314.200.37.01	
353.200.16.01	353.200.17.01	

OGNI RIFERIMENTO ORIGINALE E' ASSOLUTAMENTE INDICATIVO. CHAQUE REFERENCE ORIGINAL EST ABSOLUMENT INDICATIVE. EVERY ORIGINAL PART NUMBER HAS TO BE CONSIDERED FOR REFERENCE PURPOSE ONLY.



SUITABLE

# UNIMOG - MB TRAC MERCEDES BENZ

Tel: +44(0)1925 850082 Fax: +44(0)1925 850083

www.spwaterpumps.co.uk



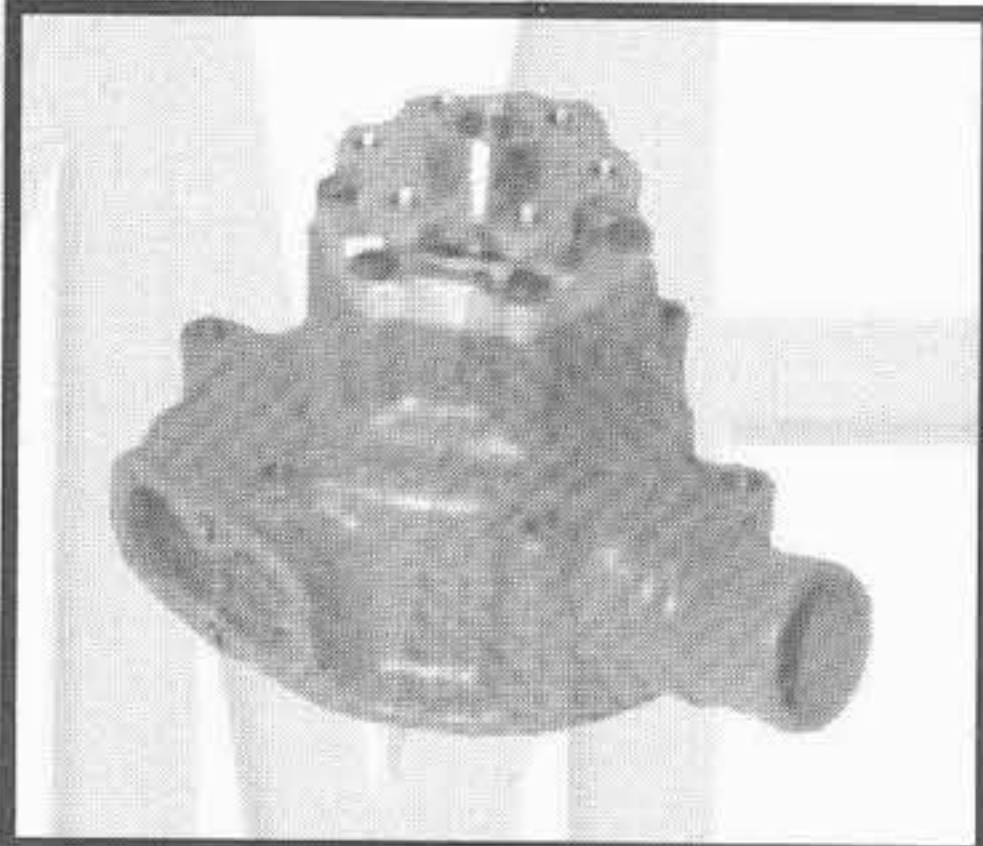
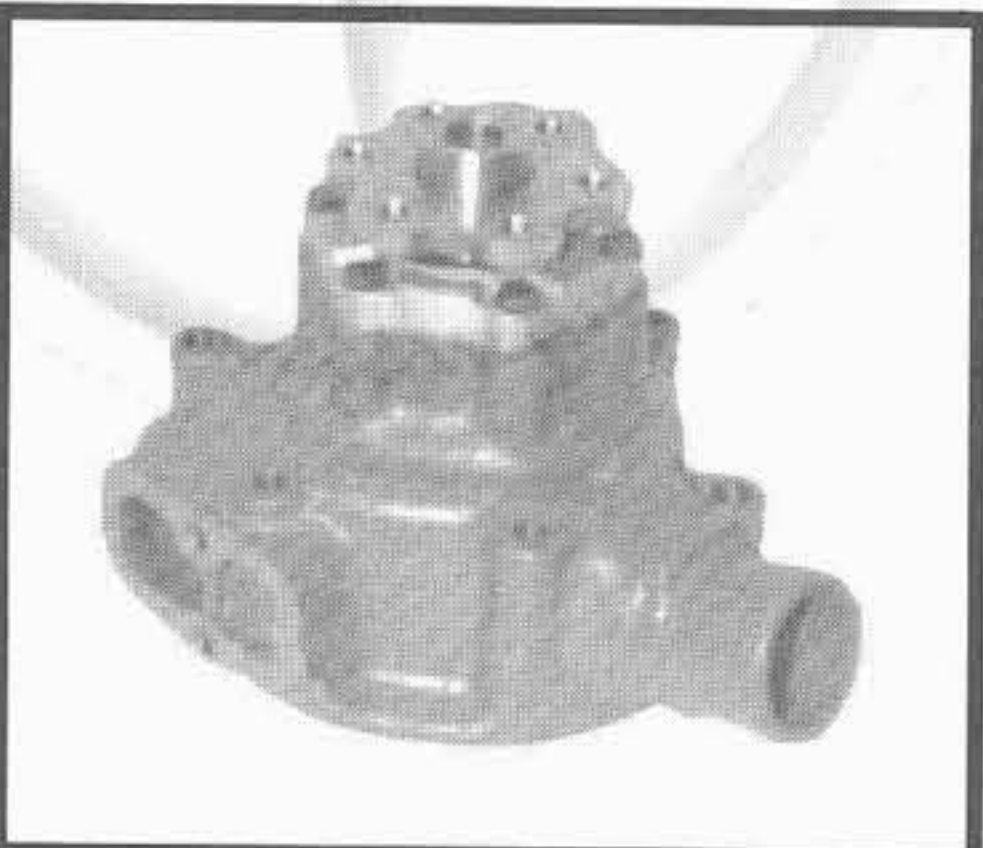
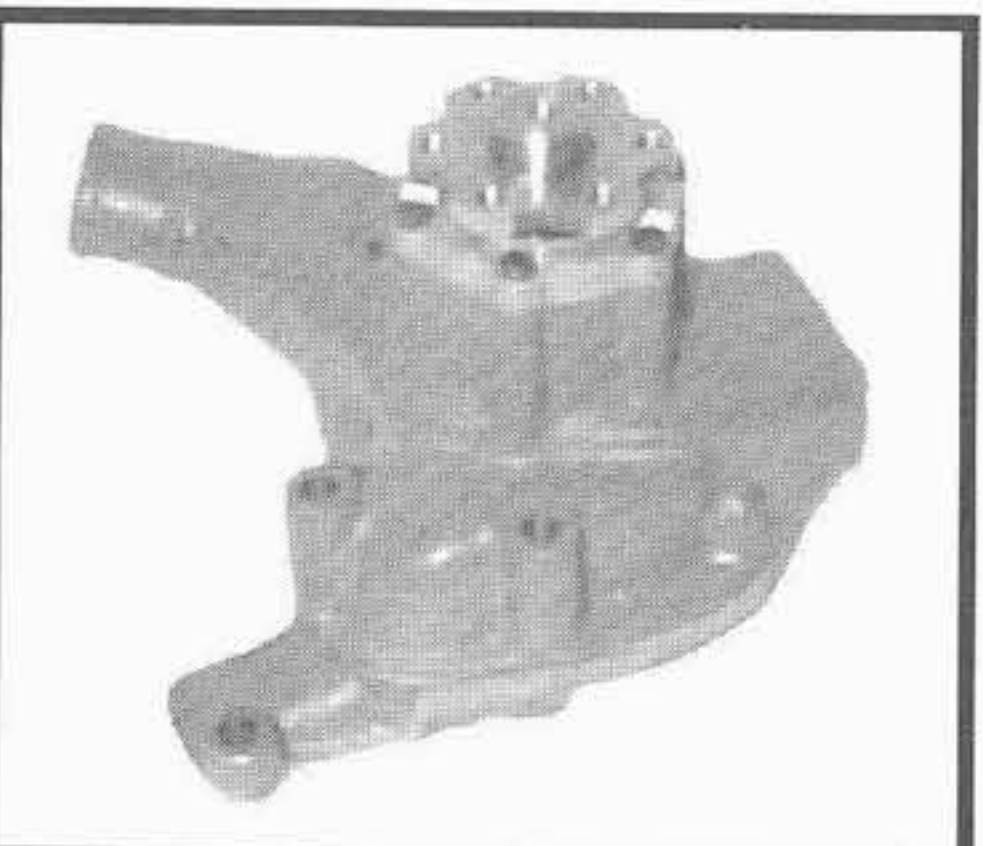

TIPO O MODELLO TYPE OU MODELE TYPE OR MODEL	MOTORE MOTEUR ENGINE	POMPA ACQUA POMPE A EAU WATER PUMP	KIT RIPARAZIONE NECESSAIRE DE REP. REPAIR KIT
U 54 / 403 U 60 / 413 U 66 / 403 U 72 / 403 - U 72 / 413 U 84 / 406 - U 80 / 416 U 800 - U 800 L  <b>MB - TRAC</b>  65 / 70 - 95 / 105  700 / 440 - 800 / 440 - 900 / 440	OM 314  --> mot. 430644	--- 314.200.24.01  <div style="border: 1px solid black; padding: 10px; text-align: center;">                         SOST. DA :                          /                          REPLACE BY :    <b>241.900</b>                            314.200.42.01                     </div> albero con foro filettato / shaft with threaded bore girante / impeller Ø 87 mm	<b>242.223</b> 314.200.09.04  <div style="border: 1px solid black; height: 100px; width: 100%;"></div>
U 54 / 403 U 60 / 413 U 66 / 403 U 72 / 403 - U 72 / 413 U 84 / 406 - U 80 / 416 U 800 - U 800 L  <b>MB - TRAC</b>  65 / 70 - 95 / 105  700 / 440 - 800 / 440 - 900 / 440	OM 314 mot. 430645 --> --> mot. 456936	<b>241.900</b> 314.200.42.01  <div style="border: 1px solid black; padding: 10px; text-align: center;">  </div> albero con foro filettato / shaft with threaded bore girante / impeller Ø 95 mm	<b>242.224</b> 314.200.10.04  <div style="border: 1px solid black; height: 100px; width: 100%;"></div>
U 54 / 403 U 60 / 413 U 66 / 403 U 72 / 403 - U 72 / 413 U 84 / 406 - U 80 / 416 U 800 - U 800 L  <b>MB - TRAC</b>  65 / 70 - 95 / 105  700 / 440 - 800 / 440 - 900 / 440	OM 314 mot. 456937 -->	<b>241.930</b> 314.200.47.01  <div style="border: 1px solid black; padding: 10px; text-align: center;">  </div>	<b>242.225</b> 314.200.11.04  <div style="border: 1px solid black; height: 100px; width: 100%;"></div>
U 65 / 406 U 70 / 406 U 80 / 406 U 1100	OM 352.919 OM 352.902 OM 352.984 OM 352	<b>241.790</b> 353.200.40.01  <div style="border: 1px solid black; padding: 10px; text-align: center;">  </div> albero senza foro filettato / shaft without threaded bore girante / impeller Ø 87 mm	<b>242.191</b> 352.200.38.04  <div style="border: 1px solid black; height: 100px; width: 100%;"></div>

I ricambi non sono originali ma adattabili . Ogni riferimento originale é assolutamente indicativo .  
 Spare parts are not original but perfectly suitable . Every original part number has to be considered for reference purpose only .

SUITABLE

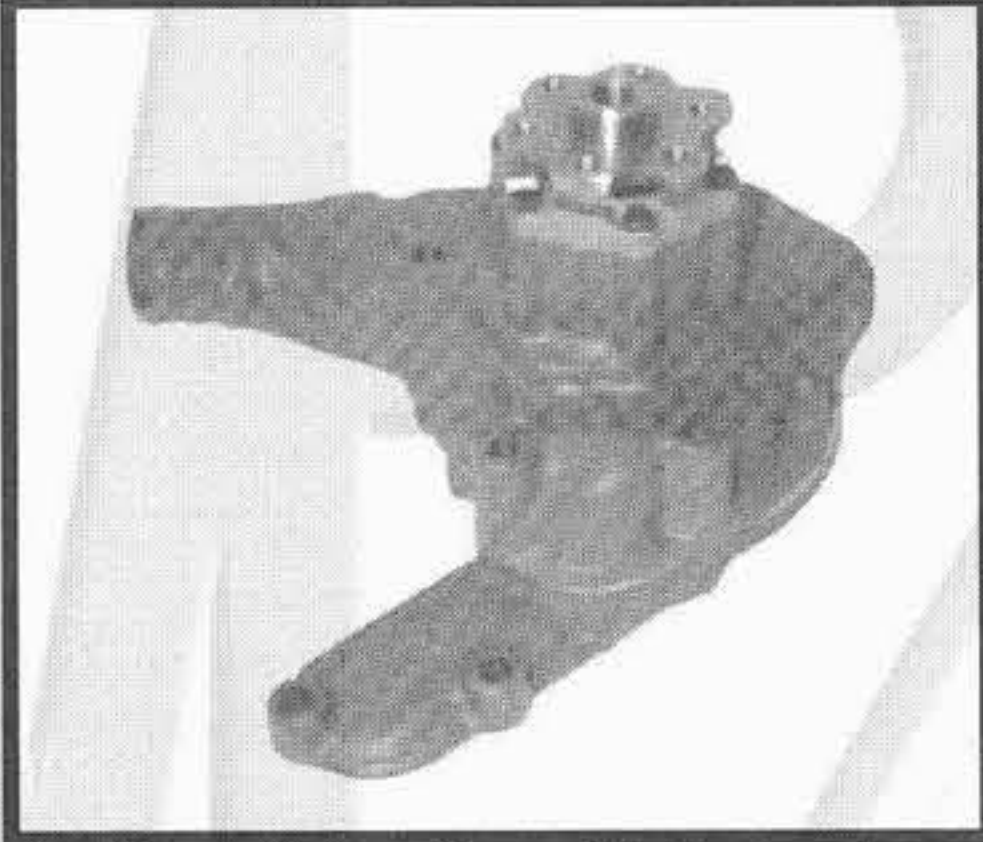
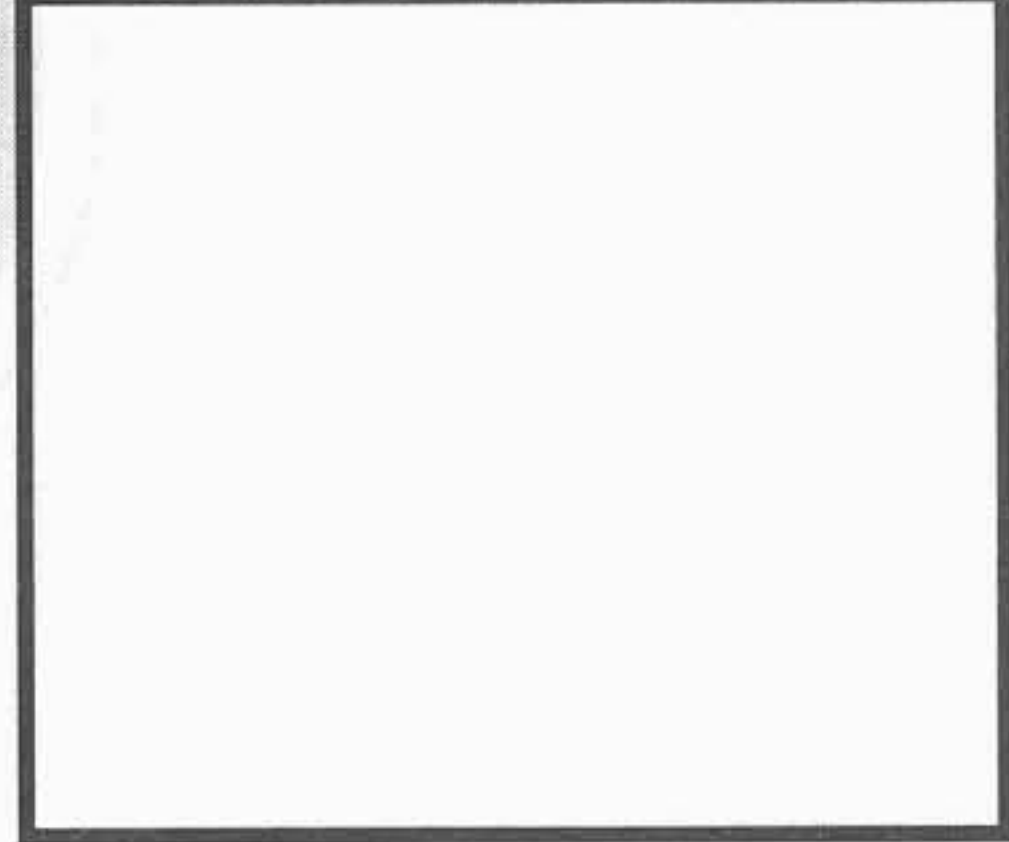
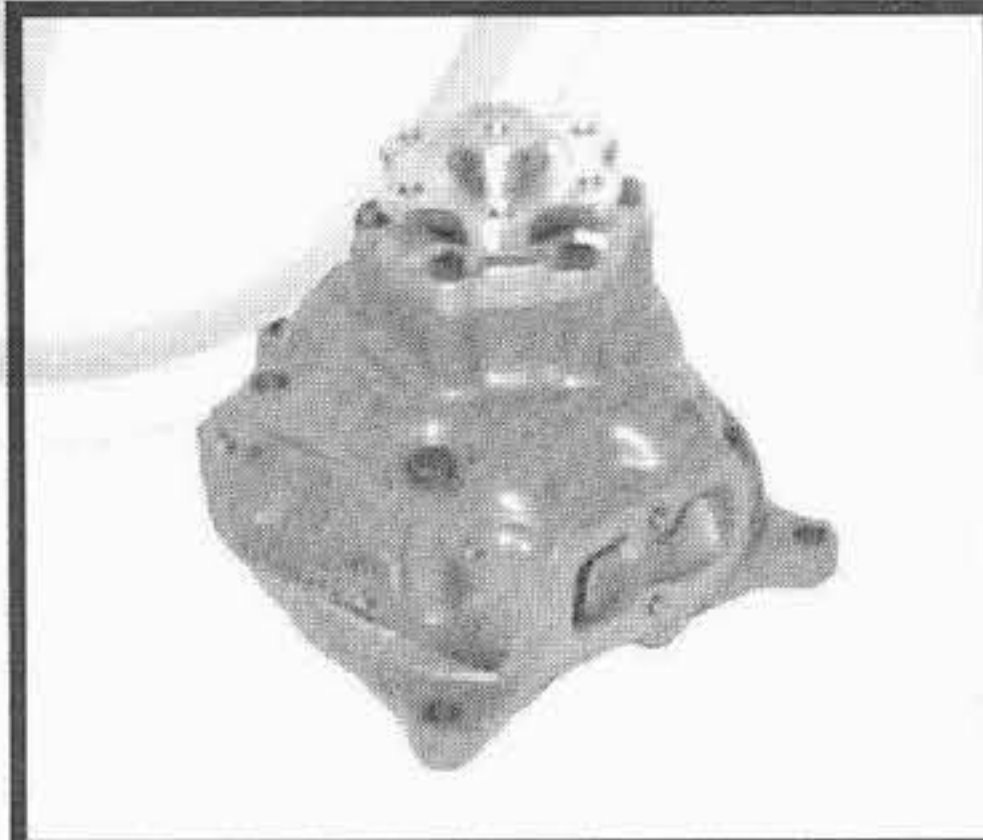
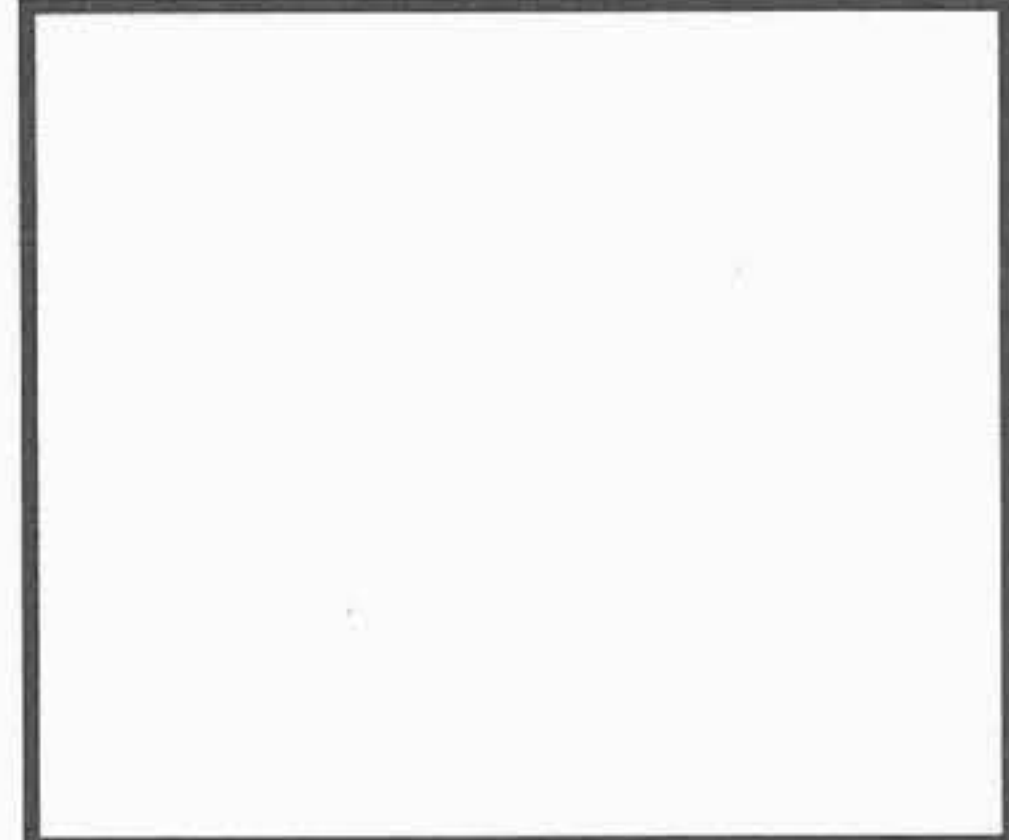
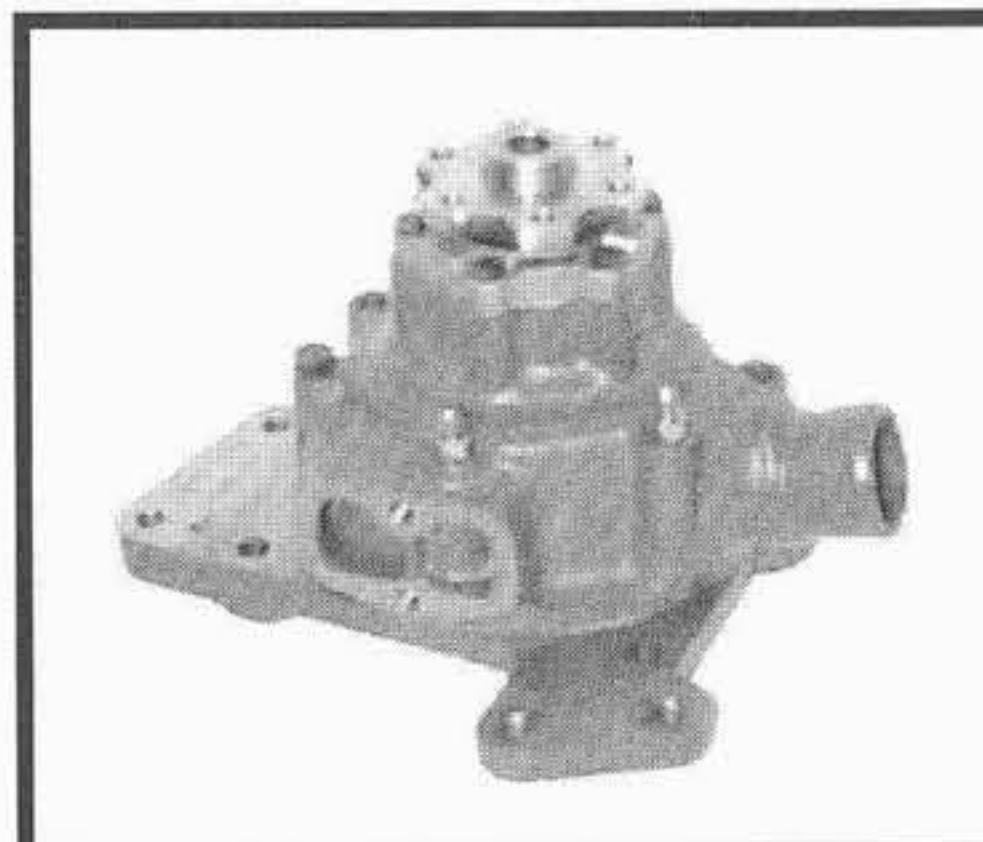
**UNIMOG - MB TRAC MERCEDES BENZ****Tel:+44(0)1925 850082 Fax: +(0)44 1925 850083****www.spwaterpumps.co.uk**

TIPO O MODELLO TYPE OU MODELE TYPE OR MODEL	MOTORE MOTEUR ENGINE	POMPA ACQUA POMPE A EAU WATER PUMP OMP REF. / O.EM. REF	KIT RIPARAZIONE NECESSAIRE DE REP. REPAIR KIT OMP REF. / O.EM. REF
U 84 / 406  U 84 / 416	OM 352	--- 352.200.94.01  <b>SOST. DA : / REPLACE BY :</b>  <b>241.935</b>  353.200.37.01  albero senza foro filettato / shaft without threaded bore girante / impeller Ø 87 mm	<b>242.191</b> 352.200.38.04  
U 84 / 406 U 84 / 416 U 90 / 416 U 95 / 424 U 100 / 416 U 150 / 425 U 900 - U 1300  <b>MB - TRAC</b> 1000 - 1100	OM 352  OM 352.901 OM 352.905 OM 352.907  OM 352 A  OM 352	<b>241.935</b> 353.200.37.01    albero con foro filettato / shaft with threaded bore girante / impeller Ø 95 mm	<b>242.229</b> 352.200.44.04  
U 110 / 406 - U 110 / 416 U 120 / 425 U 125 / 416 - U 125 / 425 U 1000 - U 1000 L - U 1000 T U 1200 - U 1300 L U 1500 - U 1700 L  <b>MB - TRAC</b> 1300 / 443 1500 / 443	OM 352  OM 352 A  OM 352  OM 352 A	<b>241.945</b> 353.200.39.01    albero senza foro filettato / shaft without threaded bore girante / impeller Ø 95 mm	<b>242.146</b> 352.200.42.04  
<b>MB - TRAC</b> 1000 / 441	OM 352 A	<b>241.990</b> 353.200.20.01    albero con foro filettato / shaft with threaded bore girante / impeller Ø 95 mm	<b>242.230</b> 352.200.45.04  

I ricambi non sono originali ma adattabili . Ogni riferimento originale é assolutamente indicativo .

Spare parts are not original but perfectly suitable . Every original part number has to be considered for reference purpose only .



**SECTION 3412**

**APPLICATION**

**VOLVO BM**

**WATER PUMPS WASSERPUMPEN  
POMPE A EAU BOMBA DE AGUA  
POMPA ACQUA**

**S.P. WATER PUMPS LTD**  
18 Tatton Court, Kingsland Grange, Woolston,  
Warrington, Cheshire. ENGLAND. WAI 4RR  
TEL: +44(0) 1925 850082 Fax: +44(0) 1925 850083  
Email:sales@spwaterpumps.co.uk Web Site:www.spwaterpumps.co.uk





SUITABLE

# VOLVO BM TRACTORS

Tel: +44(0)1925 850082 Fax: +(0)44 1925 850083

www.spwaterpumps.co.uk

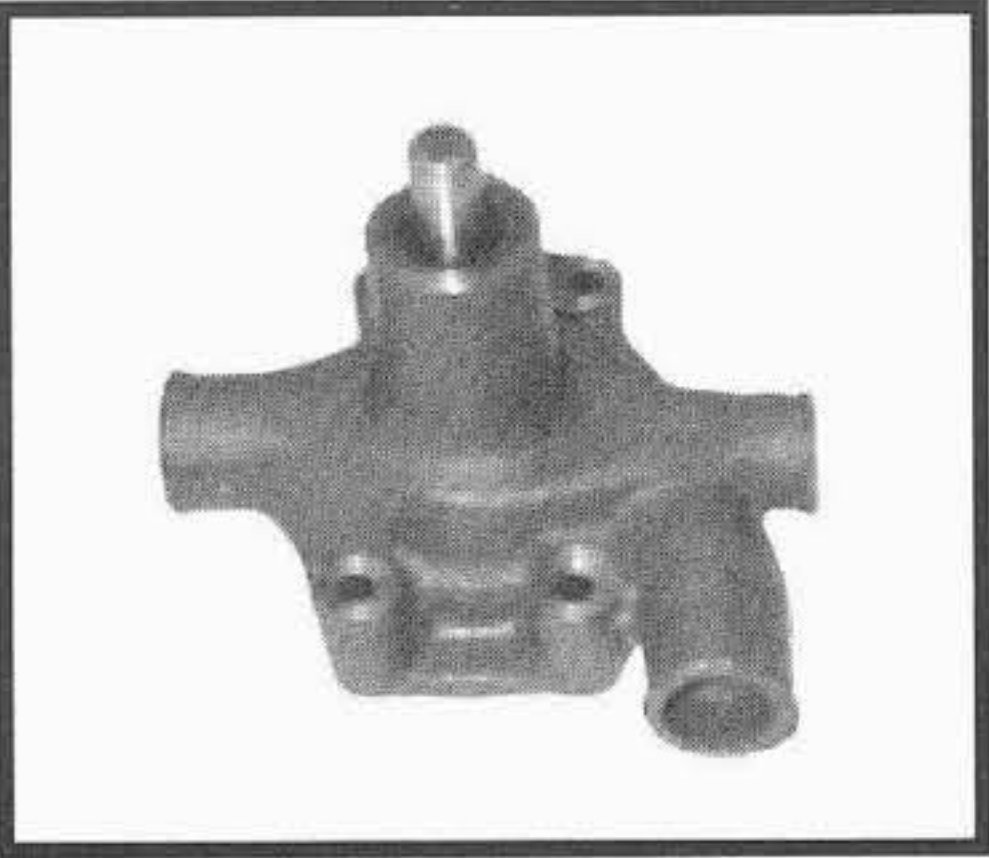

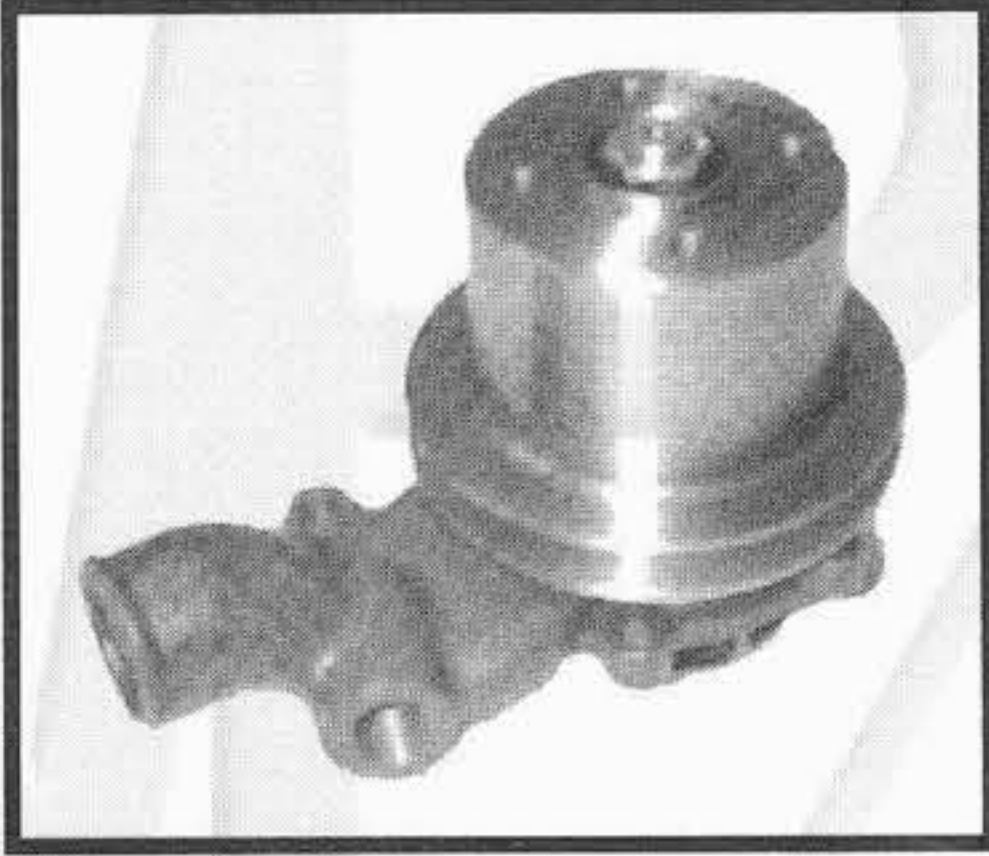
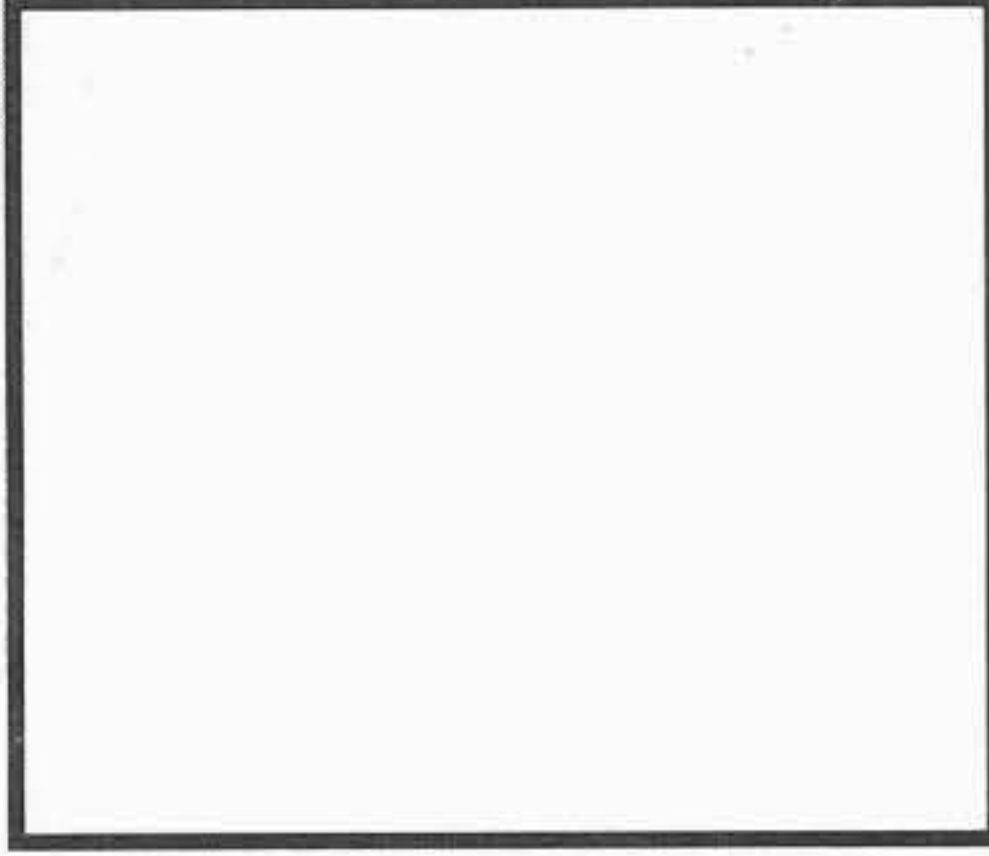
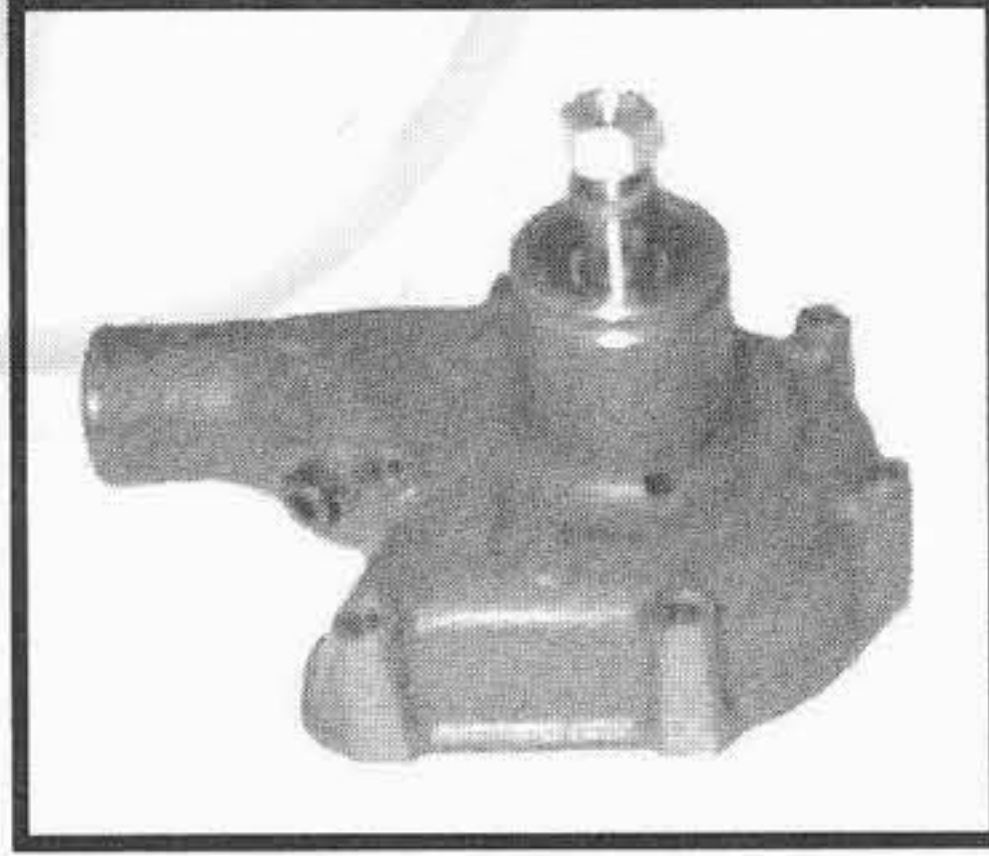
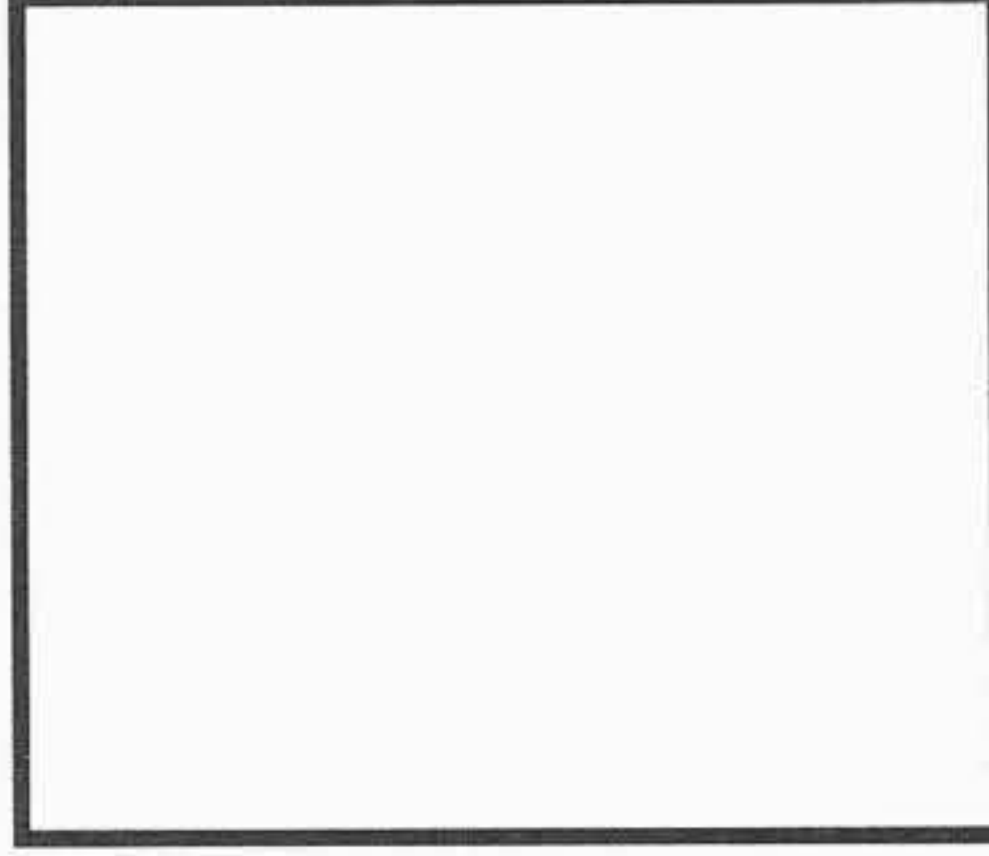
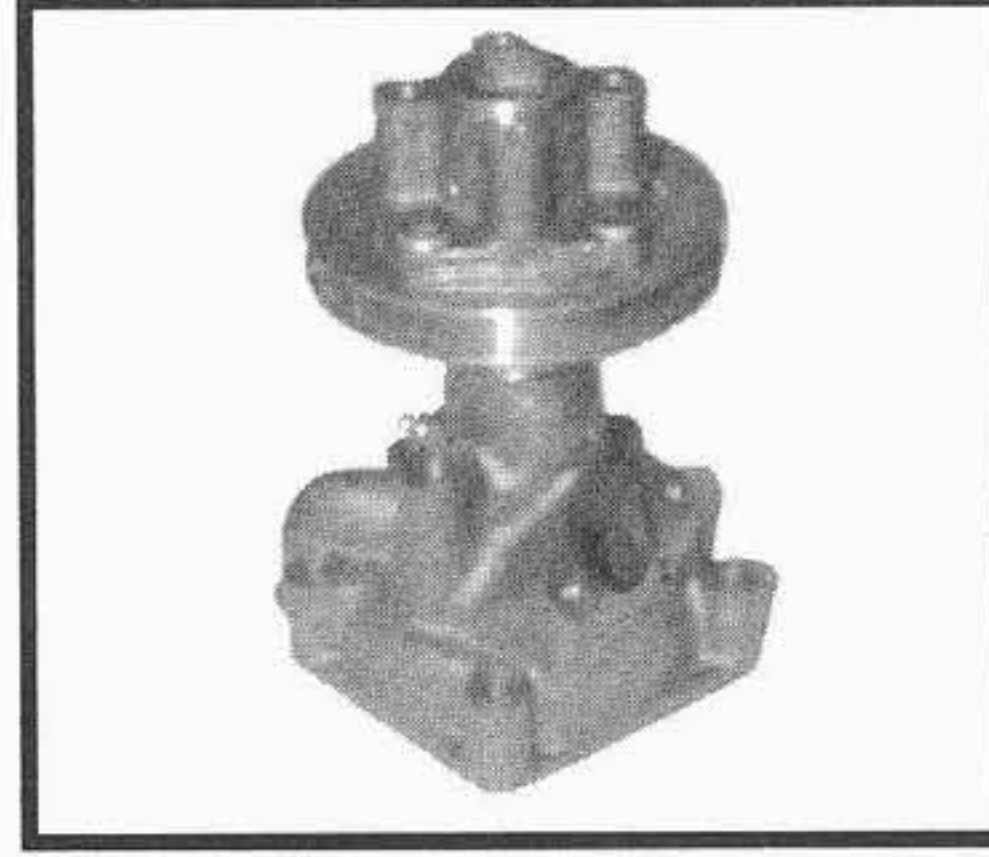
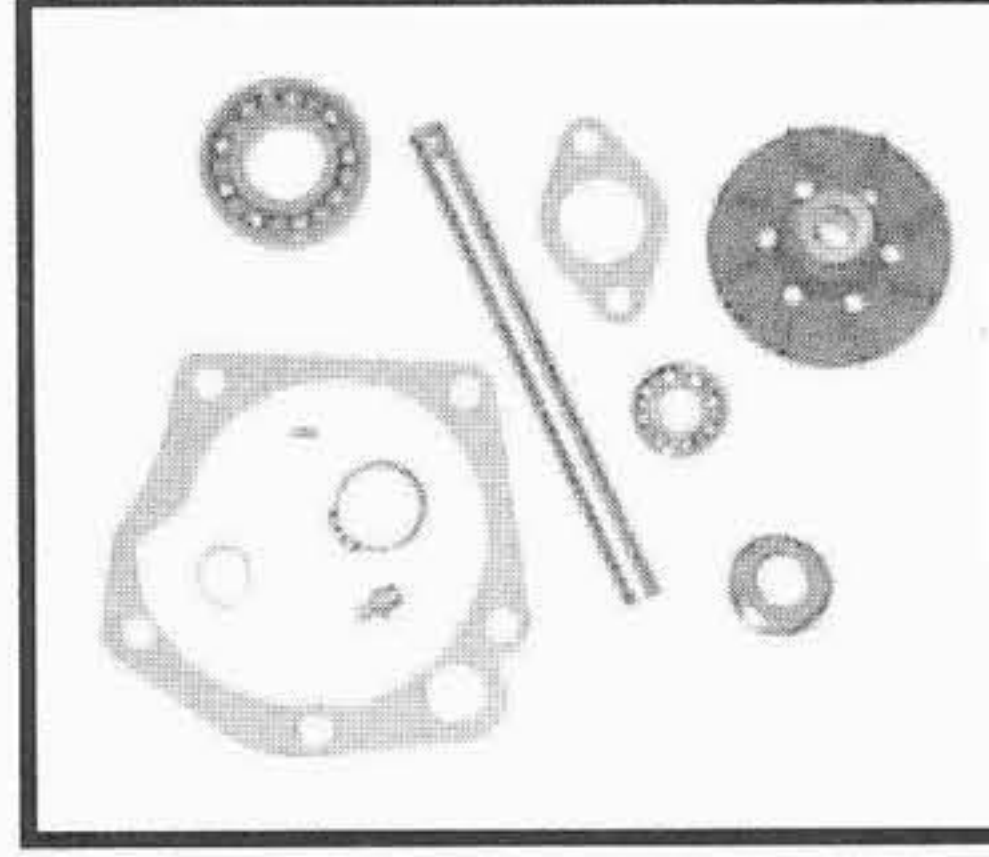
TIPO O MODELLO TYPE OU MODELE TYPE OR MODEL	MOTORE MOTEUR ENGINE	POMPA ACQUA POMPE A EAU WATER PUMP	KIT RIPARAZIONE NECESSAIRE DE REP. REPAIR KIT
		OMP REF. / O.E.M. REF	OMP REF. / O.E.M. REF
BM 320  BM 400 BM 430	A3.152  AD3.152	<b>319.375</b> 6613.038  	<b>312.130</b> 754.108  
BM 500  2200 - 2204  2250 - 2254	4.236	<b>319.450</b> 484.120A CON PULEGGIA / WITH PULLEY  <b>319.490</b> 484.120 SENZA PULEGGIA / WITHOUT PULLEY	<b>312.176</b> 275.614  
BM 950	6.354	<b>159.090</b> 41313045  	<b>152.097</b> U7LW0009  
BM 350 BOXER BM 600 BOXER		<b>317.140</b> 772.781  	<b>312.289</b>  

I ricambi non sono originali ma adattabili . Ogni riferimento originale é assolutamente indicativo .  
 Spare parts are not original but perfectly suitable . Every original part number has to be considered for reference purpose only .



SUITABLE

# VOLVO BM TRACTORS

Tel:+44(0)1925 850082 Fax: +(0)44 1925 850083

www.spwaterpumps.co.uk

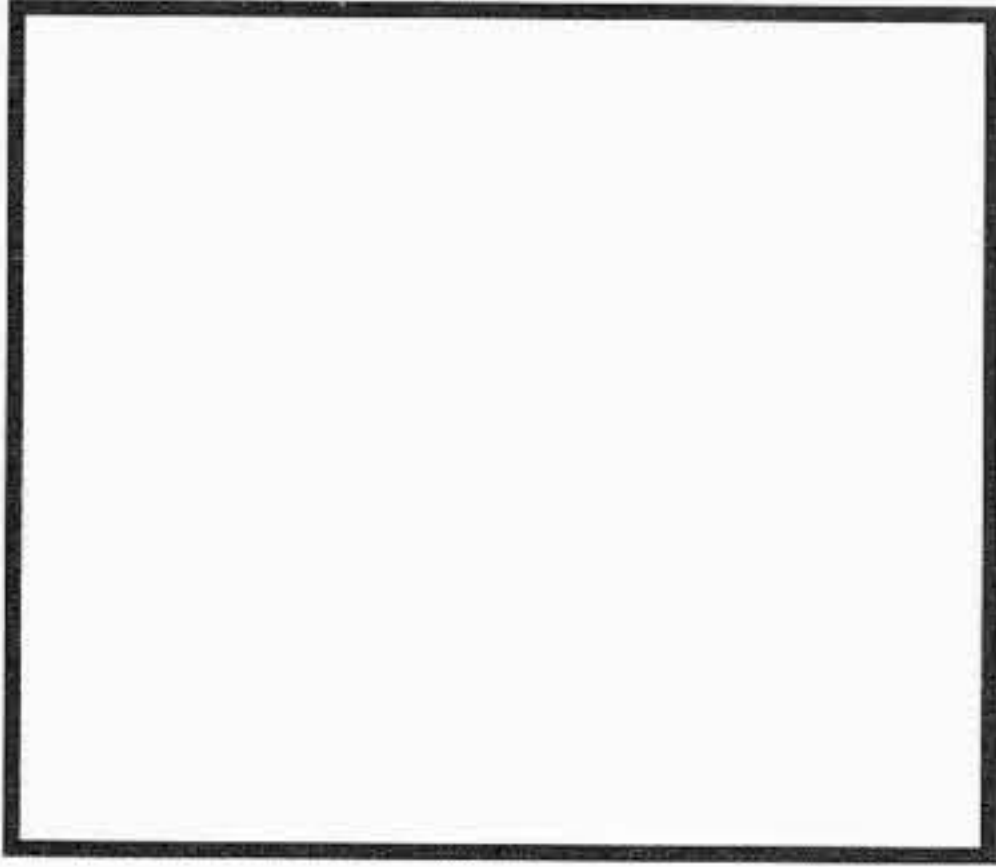
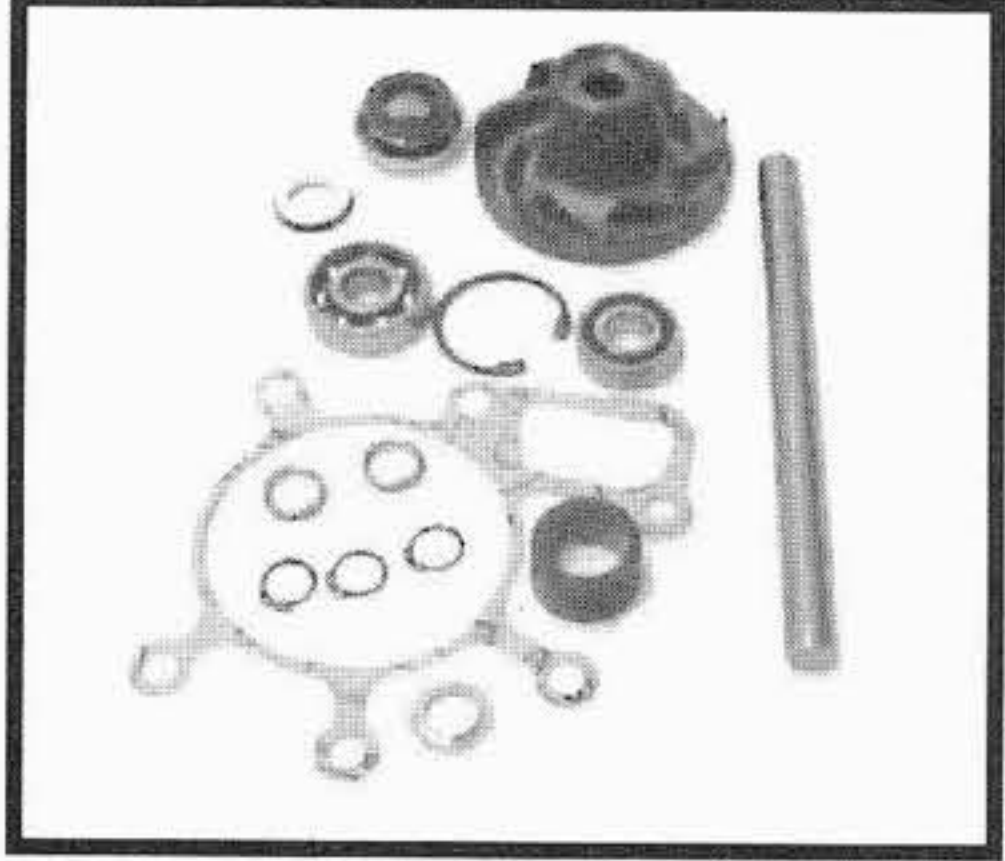
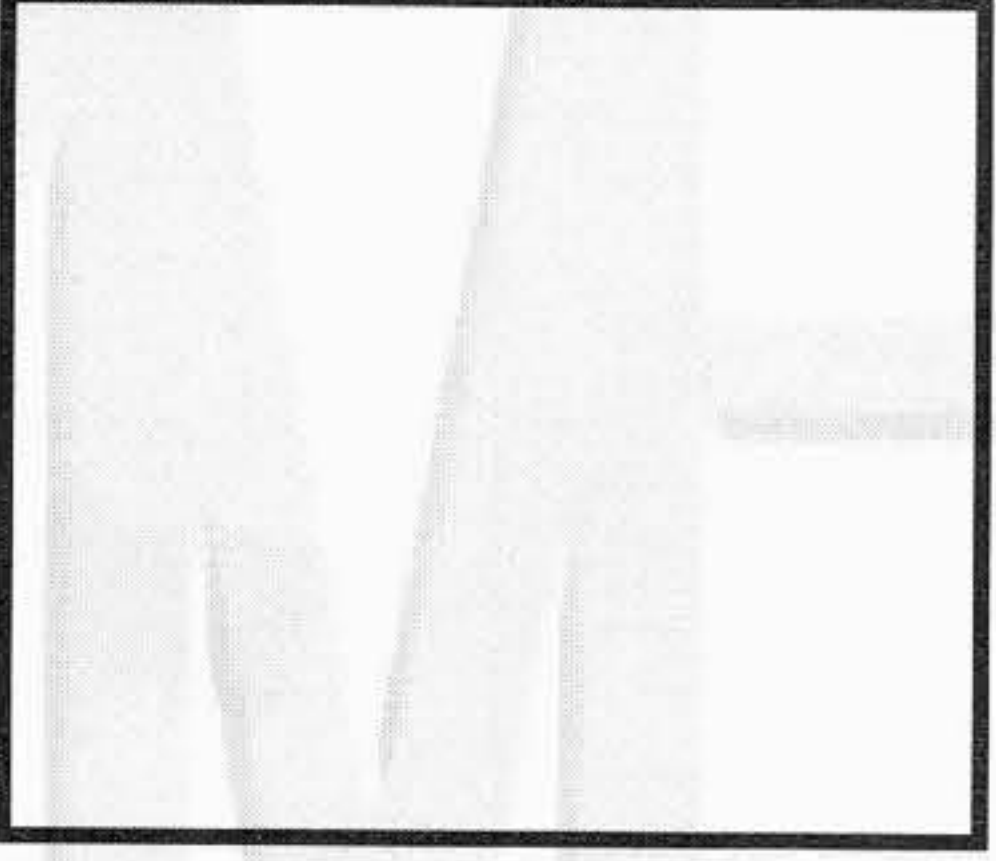
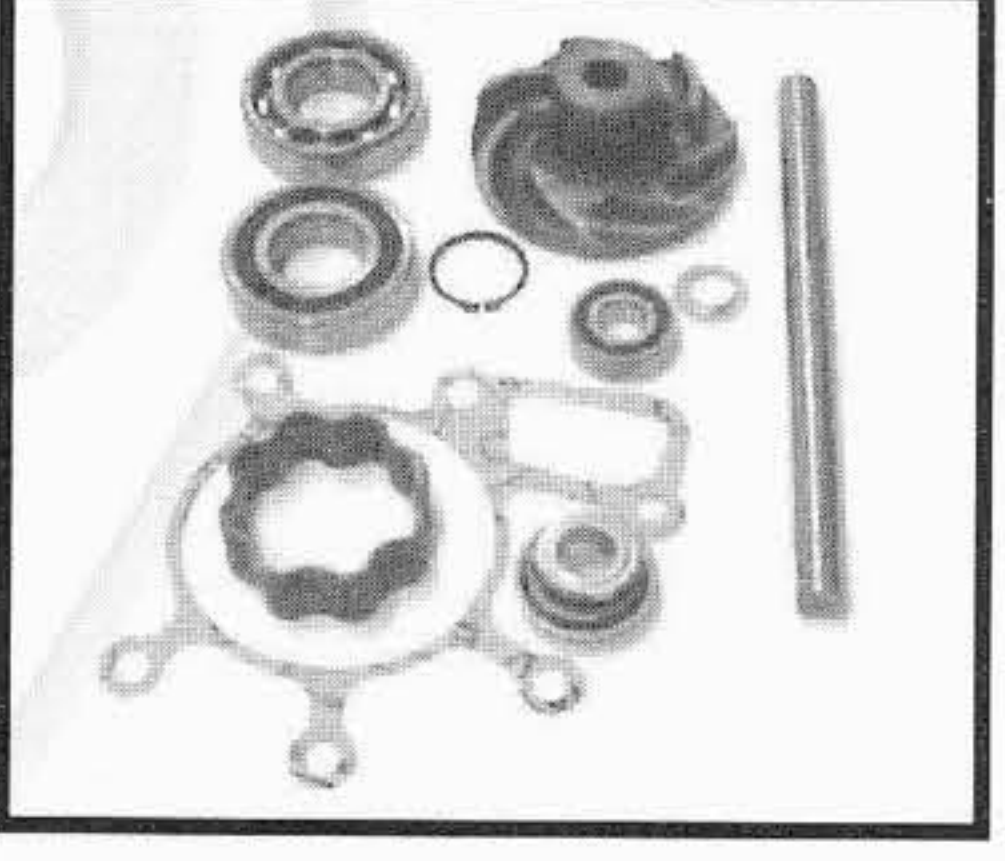
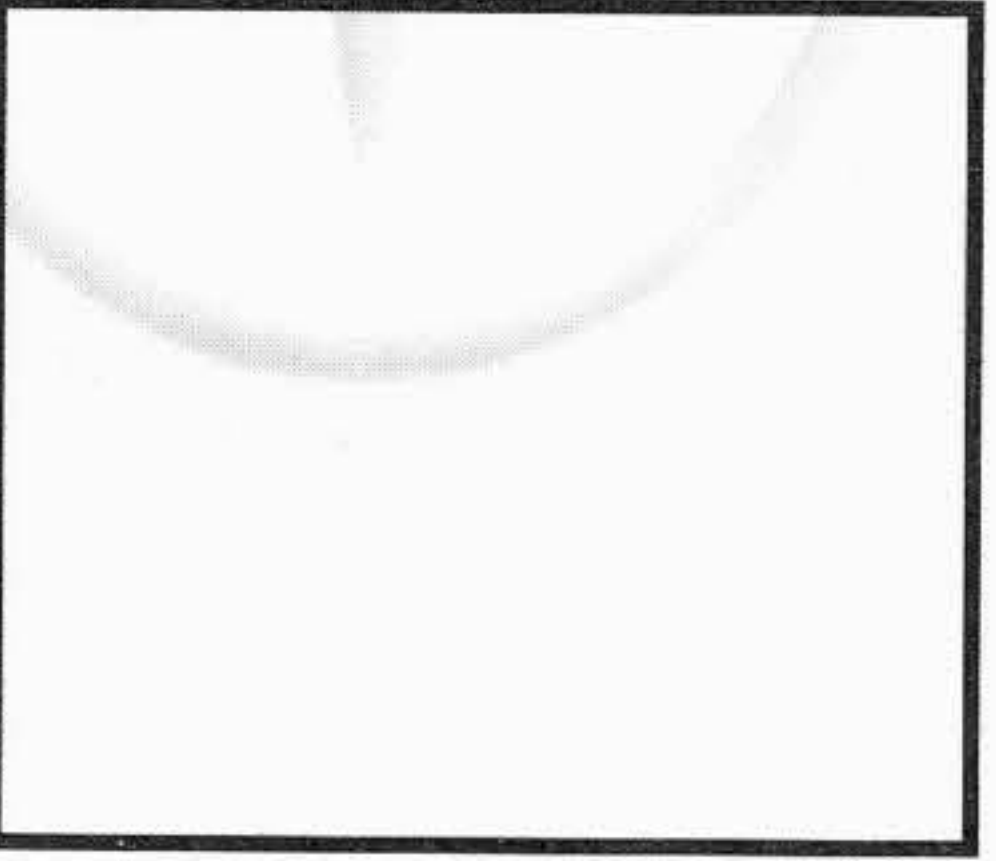
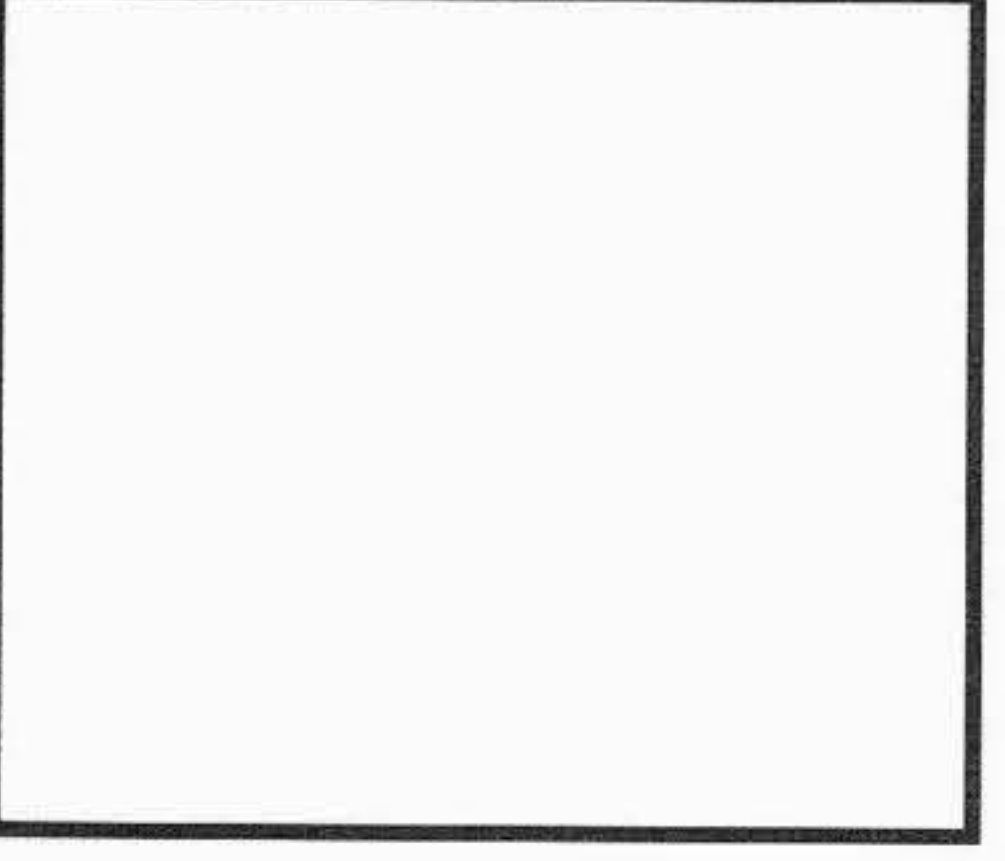
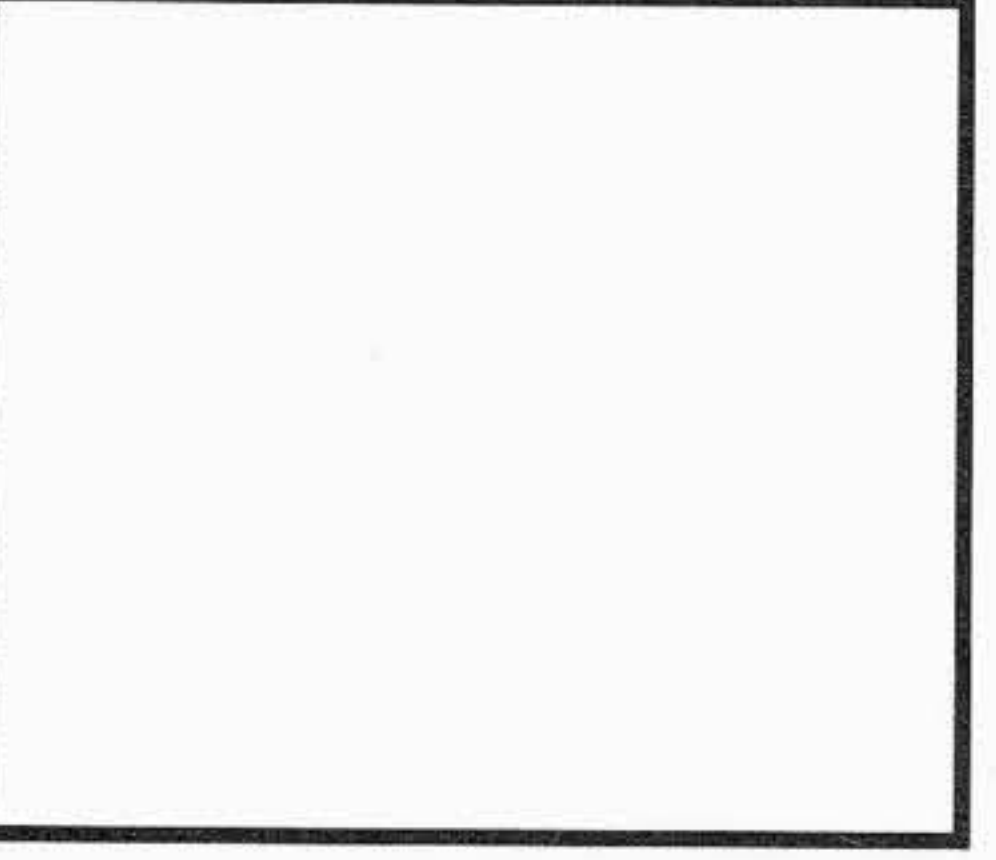
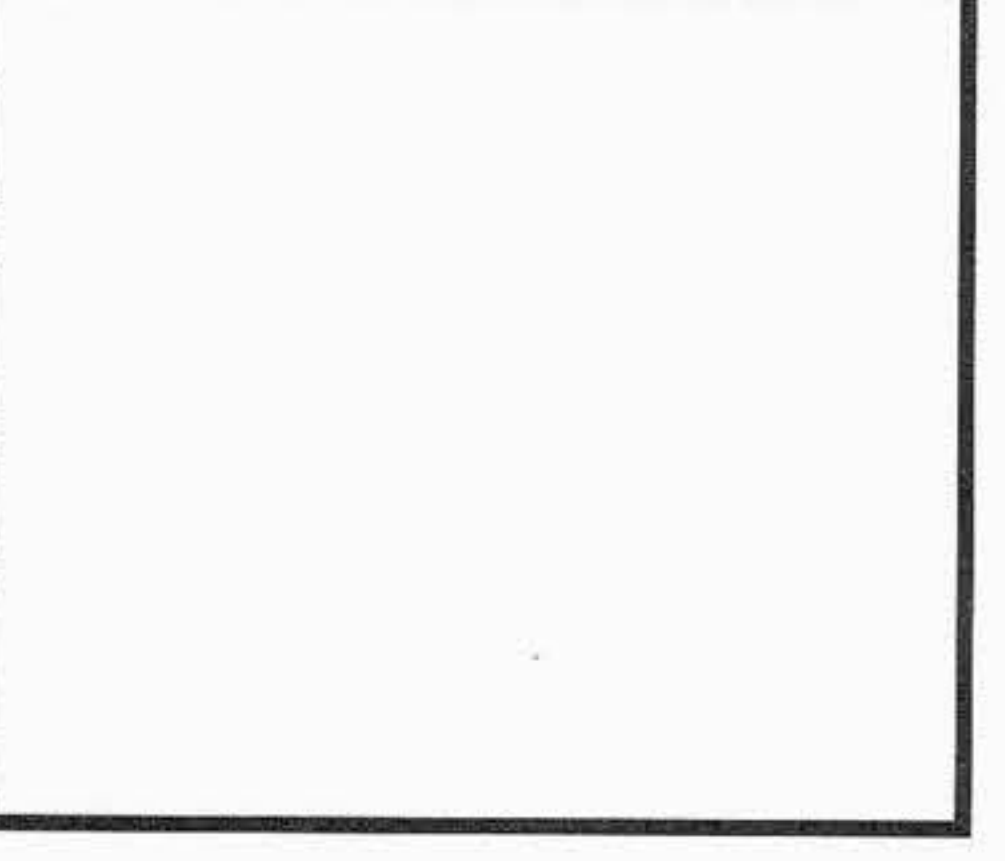

TIPO O MODELLO TYPE OU MODELE TYPE OR MODEL	MOTORE MOTEUR ENGINE	POMPA ACQUA POMPE A EAU WATER PUMP	KIT RIPARAZIONE NECESSAIRE DE REP. REPAIR KIT
LM 621 - LM 622 LM 641 - LM 642 - LM 646 BM 650 LM 840 - LM 841	D 42 A D 45 D 45 B		<b>312.283</b> 11701.095  EX 754.569
BM 650 TURBO BM 700 BM 646 BM 615B L 50 L 70 4200 B			<b>312.284</b> 11701.087  EX 6630.337
BM 800 BM 810 BM 861 BM 2650 BM 4400 BM 4400 S BM 4400 C BM 4500 BM 4500 S	TD 60 B TD 70 H		<b>312.288</b> 11701.442  EX 630.590 - 6630.830 11000.108
			

I ricambi non sono originali ma adattabili . Ogni riferimento originale é assolutamente indicativo .  
 Spare parts are not original but perfectly suitable . Every original part number has to be considered for reference purpose only .



**SECTION 4113**

**APPLICATION**

**VOLVO**  
**PENTA**

**INDUSTRIAL ENGINES**

**WATER PUMPS WASSERPUMPEN**  
**POMPE A EAU BOMBA DE AGUA**  
**POMPA ACQUA**

**S.P. WATER PUMPS LTD**  
18 Tatton Court, Kingsland Grange, Woolston,  
Warrington, Cheshire. ENGLAND. WAI 4RR  
TEL: +44(0) 1925 850082 Fax: +44(0) 1925 850083  
Email:sales@spwaterpumps.co.uk Web Site:www.spwaterpumps.co.uk

SUITABLE

**VOLVO**





**PENTA**

MOTORI

Tel:+44(0)1925 850082 Fax: +(0)44 1925 850083

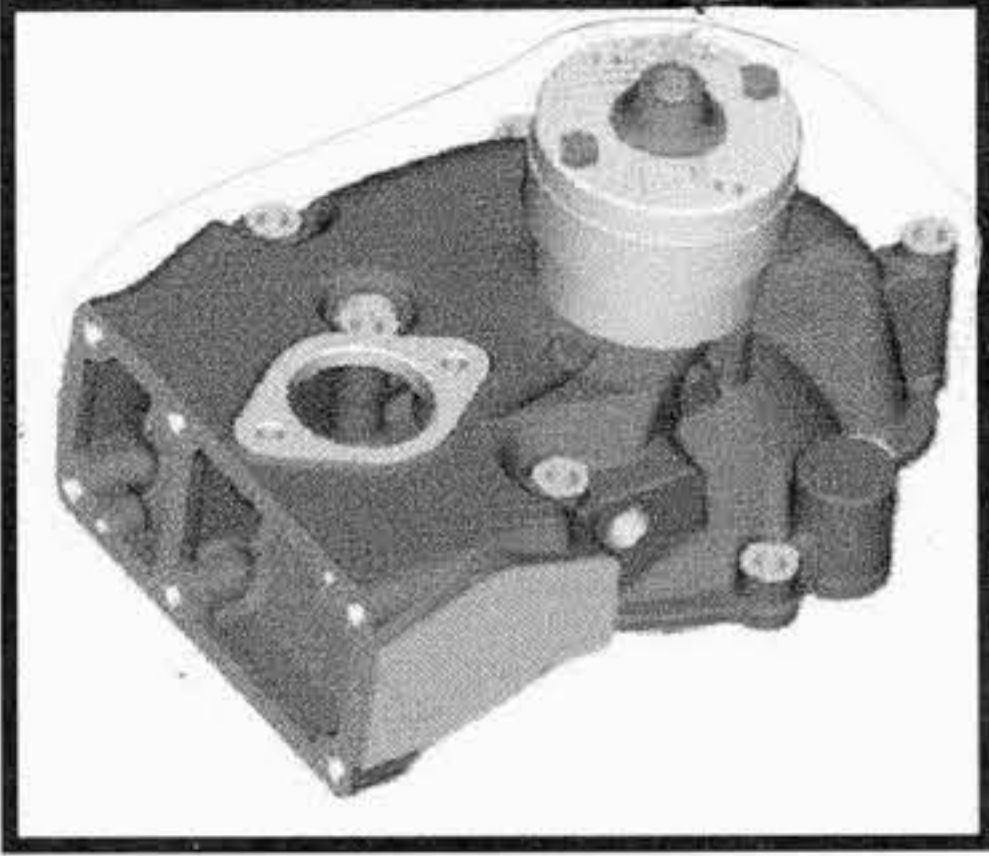
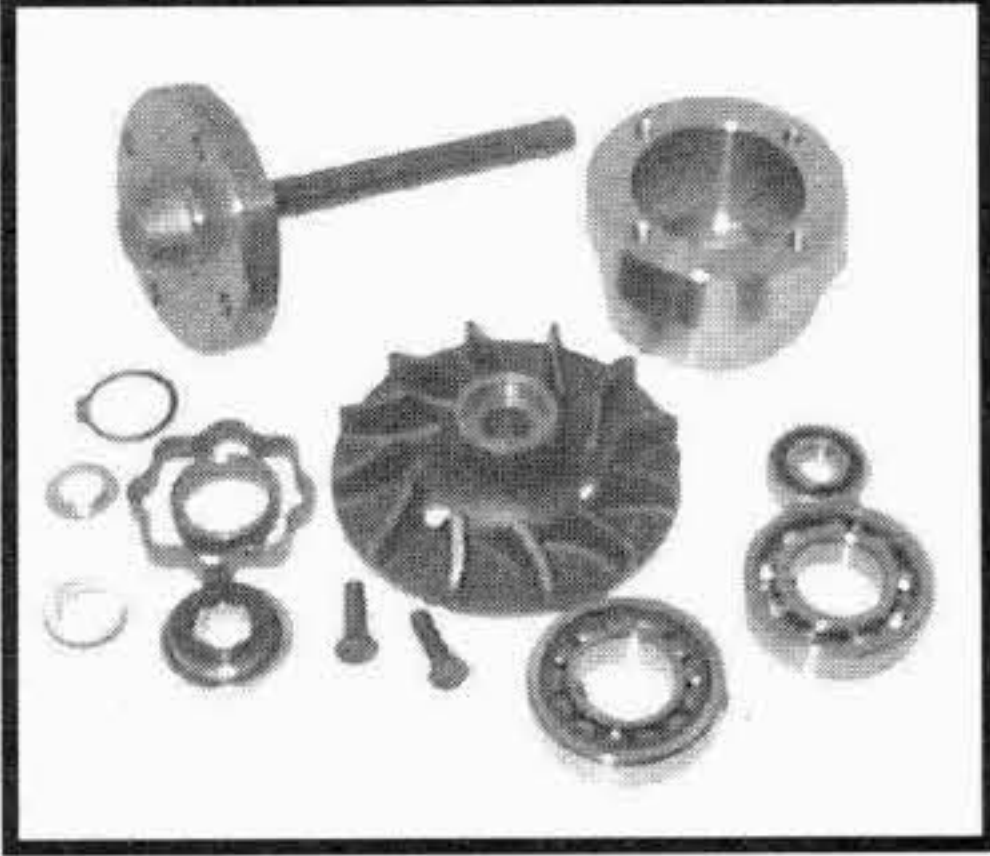
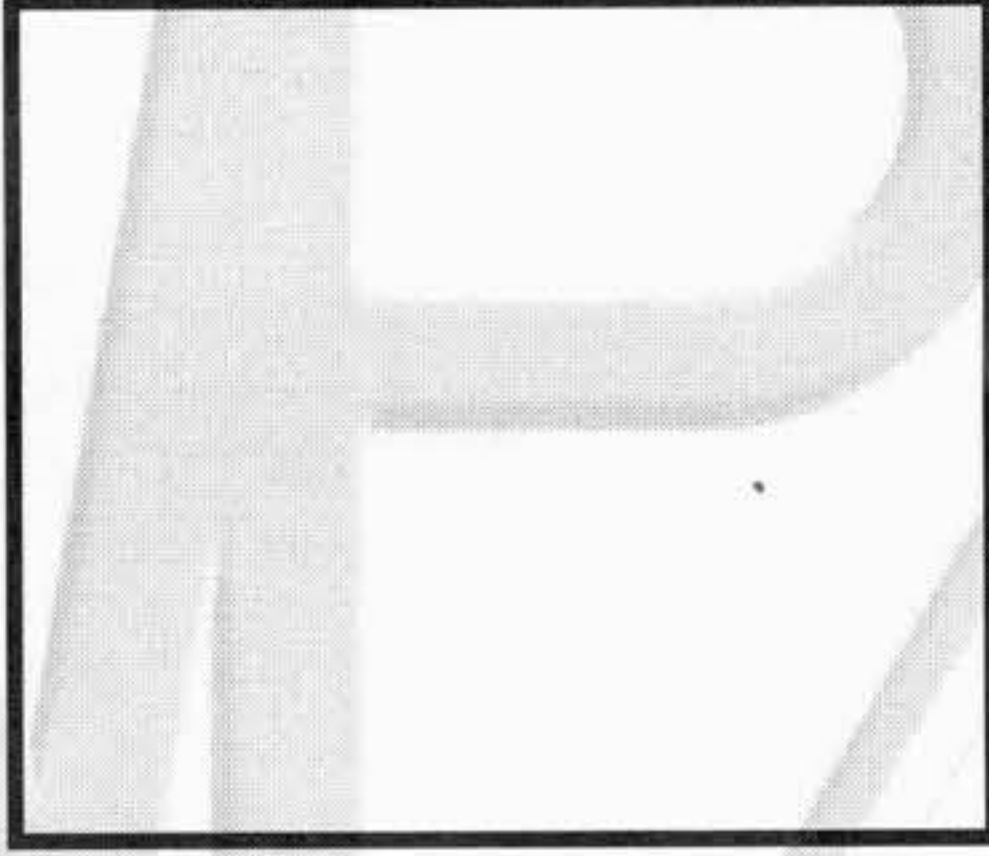
www.spwaterpumps.co.uk

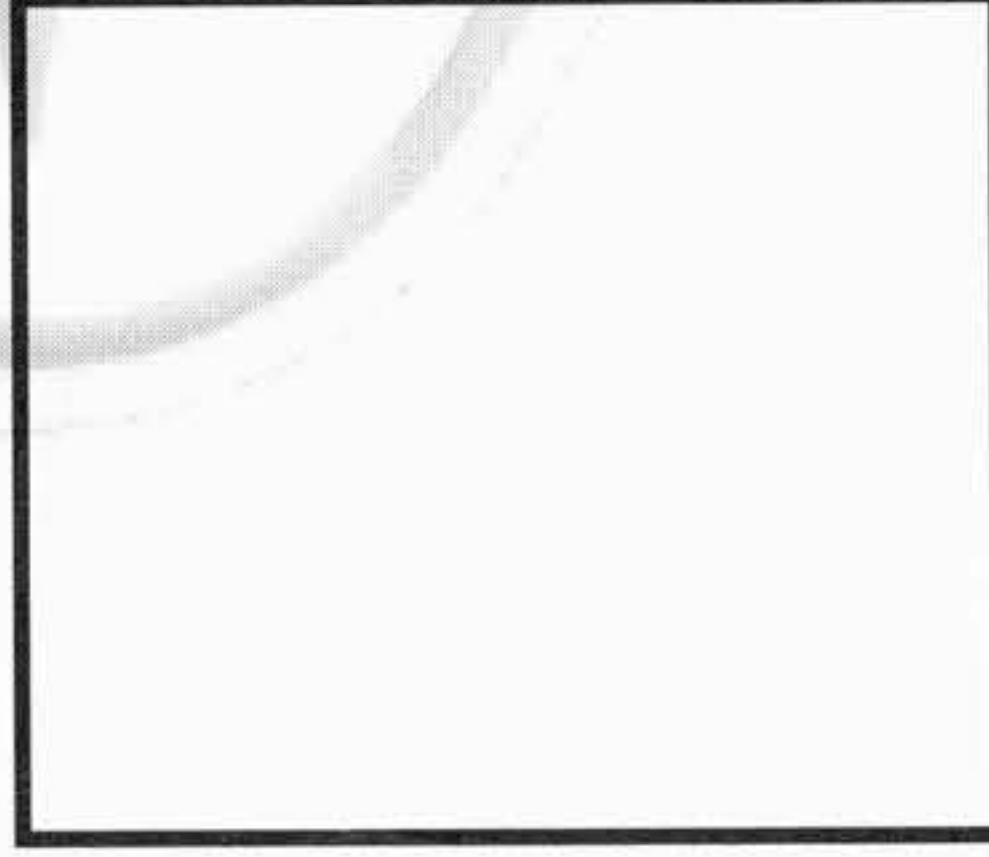

TIPO O MODELLO TYPE OU MODELE TYPE OR MODEL	MOTORE MOTEUR ENGINE	POMPA ACQUA POMPE A EAU WATER PUMP	KIT RIPARAZIONE NECESSAIRE DE REP. REPAIR KIT
		OMP REF. / O.EM. REF	OMP REF. / O.EM. REF
<p><b>NEW !!</b></p>	TD 100 G	<p>--- 844.379</p> 	<p>312.290 875.661</p> 
<p><b>NEW !!</b></p>	F 4 TD 40 A	<p>317.130 1699.782</p> 	<p>312.177 275.617</p> 
<p><b>NEW !!</b></p>	FL 4 TD 41 G	<p>--- 1698.622</p> 	<p>--- ---</p> <p><b>NON DISPONIBILE NOT AVAILABLE</b></p>
<p><b>NEW !!</b></p>	FLC D4A 135	<p>319.510 ---</p> 	<p>--- ---</p> <p><b>NON DISPONIBILE NOT AVAILABLE</b></p>

I ricambi non sono originali ma adattabili . Ogni riferimento originale é assolutamente indicativo .  
Spare parts are not original but perfectly suitable . Every original part number has to be considered for reference purpose only .